



N-Channel Enhancement Mode Power Mosfet

BL2306

FEATURES

- Capable of 2.5V gate drive
- Lower on-resistance
- Reliable and Rugged

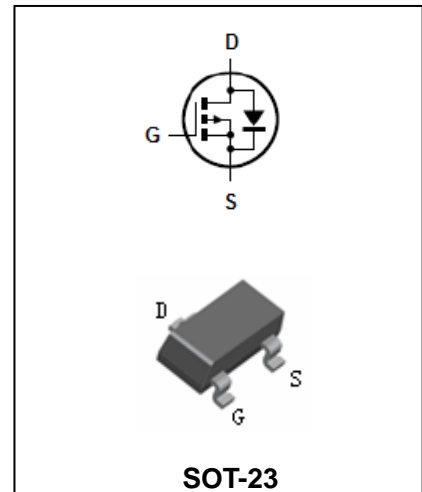

APPLICATIONS

- Power Management in Notebook.
- Portable Equipment.
- Battery Powered System.

ORDERING INFORMATION

Type No.	Marking	Package Code
BL2306	A69T	SOT-23

MAXIMUM RATING @ Ta=25°C unless otherwise specified

Symbol	Parameter	Value	Units
V _{DSS}	Drain-Source voltage	20	V
V _{GSS}	Gate -Source voltage	± 12	V
I _D	Maximum Drain current T _A =25°C T _A =70°C	5.3 4.3	A
I _{DM}	Pulsed Drain current	10	A
P _D	Power Dissipation	1.38	W
R _{θJA}	Thermal resistance,Junction-to-Ambient	90	°C/W
T _J , T _{stg}	Operating Junction and Storage Temperature Range	-55~+150	°C



N-Channel Enhancement Mode Power Mosfet

BL2306

ELECTRICAL CHARACTERISTICS @ Ta=25°C unless otherwise specified

Parameter	Symbol	Test conditions	MIN	TYP	MAX	UNIT
Drain-Source Breakdown Voltage	$V_{(BR)DSS}$	$V_{GS}=0V, I_D=250\mu A$	20	-	-	V
Gate Threshold Voltage	$V_{GS(th)}$	$V_{DS}=V_{GS}, I_D=250\mu A$	0.5	-	1.2	V
Forward Transconductance	gfs	$V_{DS}=5V, I_D=5.3A$	-	13	-	S
Gate-body Leakage	I_{GSS}	$V_{DS}=0V, V_{GS}=12V$	-	-	100	nA
		$V_{DS}=0V, V_{GS}=-12V$	-	-	-100	
Zero Gate Voltage Drain Current	I_{DSS}	$V_{DS}=20V, V_{GS}=0V$	-	-	1	μA
		$V_{DS}=16V, V_{GS}=0V$	-	-	10	
Drain-Source on-resistance	$R_{DS(ON)}$	$V_{GS}=10V, I_D=5.5A$	-	-	30	m Ω
		$V_{GS}=4.5V, I_D=5.3A$	-	-	35	
		$V_{GS}=2.5V, I_D=2.6A$	-	-	50	
		$V_{GS}=1.8V, I_D=1.0A$	-	-	90	
Diode forward voltage	V_{SD}	$V_{GS}=0V, I_S=1.2A$	-	-	1.2	V
Total Gate Charge	Qg	$V_{DS}=10V, V_{GS}=4.5V, I_D=5.3A$	-	8.7	-	nC
Gate-Source Charge	Qgs		-	1.5	-	
Gate-Drain Charge	Qgd		-	3.6	-	
Input capacitance	C_{ISS}	$V_{DS}=15V, V_{GS}=0V, f=1.0MHz$	-	603	-	pF
Output capacitance	C_{OSS}		-	144	-	
Reverse transfer capacitance	C_{RSS}		-	111	-	
Turn-On Delay Time	$t_{D(ON)}$	$V_{DS} = 15V, I_D=1A, R_G= 2\Omega, V_{GS}= 10V, R_D= 15\Omega$	-	6	-	ns
Rise Time	t_R		-	14	-	
Turn-Off Delay Time	$t_{D(OFF)}$		-	1804	-	
Fall Time	t_F		-	2.8	-	
Reverse Recovery Time	Trr	$I_S=5A, V_{GS}=0$	-	16.8	-	ns
Reverse Recovery Charge	Qrr	$dI/dt=100A/us$	-	11	-	nC

TYPICAL CHARACTERISTICS @ Ta=25°C unless otherwise specified

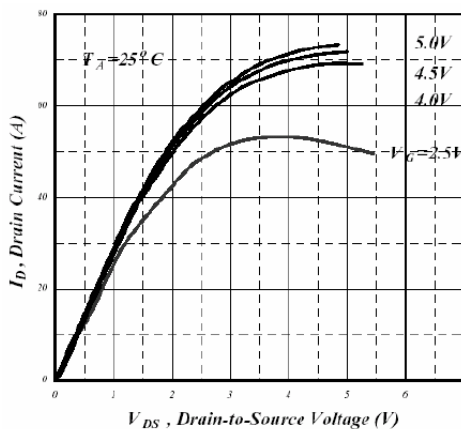

Fig 1. Typical Output Characteristics

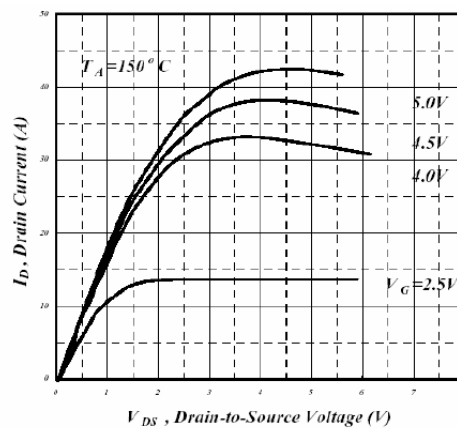

Fig 2. Typical Output Characteristics



N-Channel Enhancement Mode Power Mosfet

BL2306

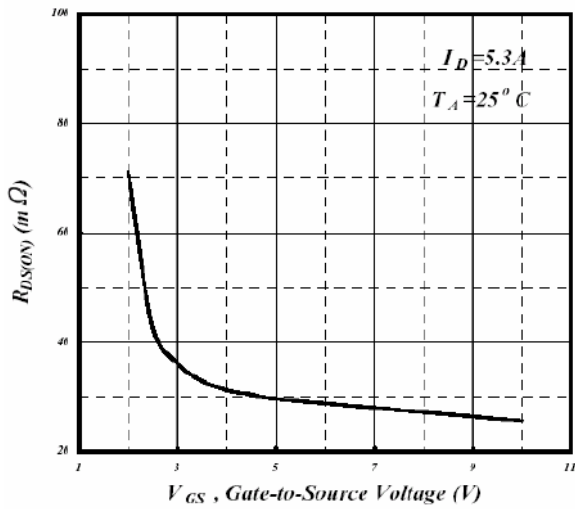

Fig 3. On-Resistance v.s. Gate Voltage

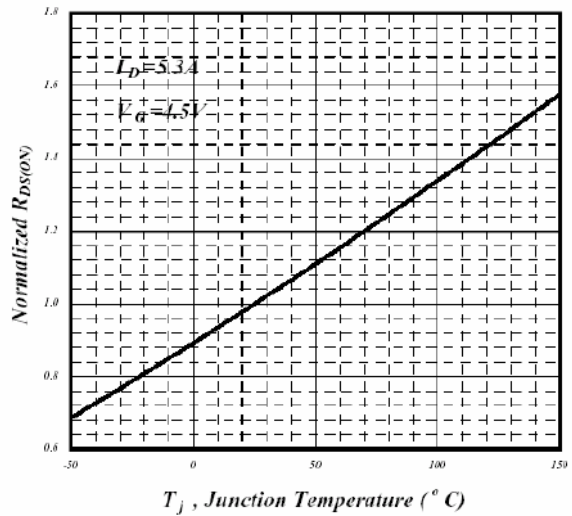

Fig 4. Normalized On-Resistance v.s. Junction Temperature

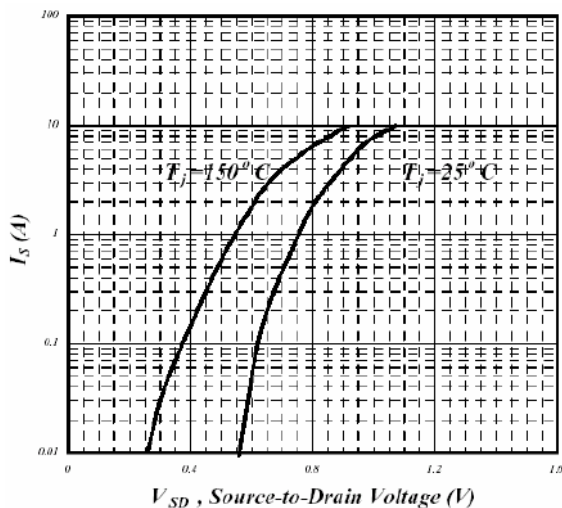

Fig 5. Forward Characteristic of Reverse Diode

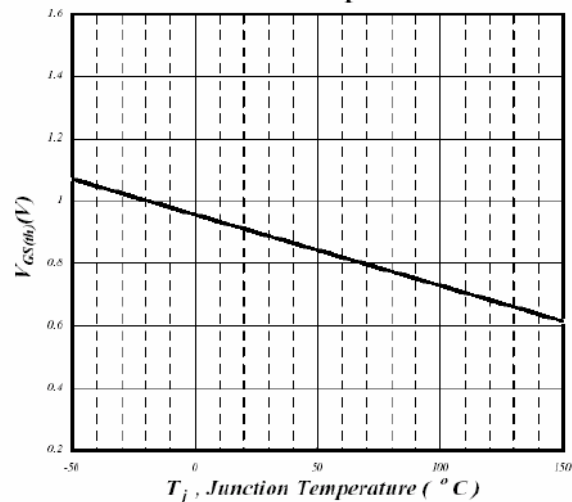

Fig 6. Gate Threshold Voltage v.s. Junction Temperature

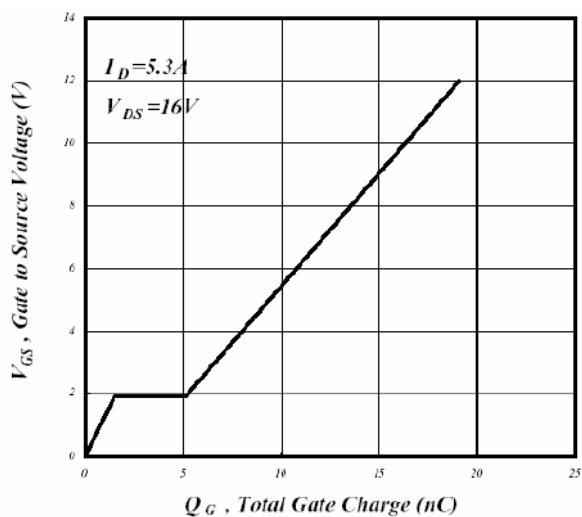

Fig 7. Gate Charge Characteristics

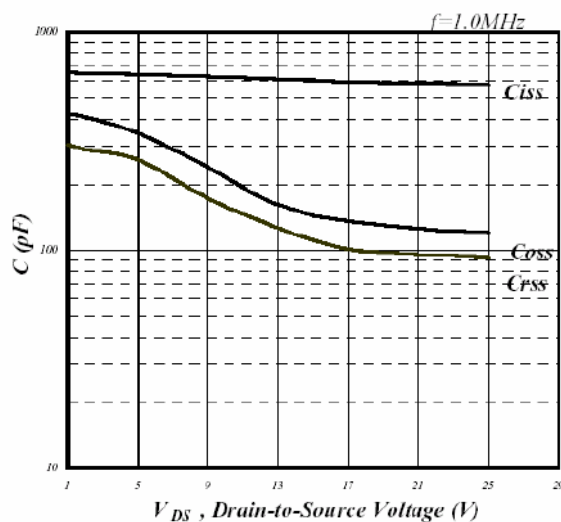

Fig 8. Typical Capacitance Characteristics

N-Channel Enhancement Mode Power Mosfet

BL2306

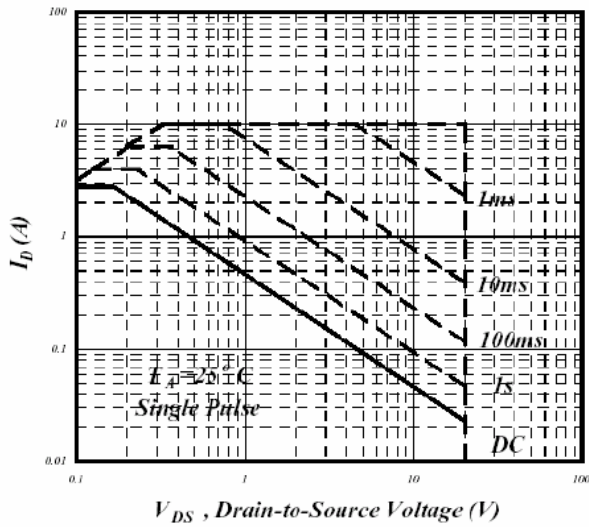

Fig 9. Maximum Safe Operating Area

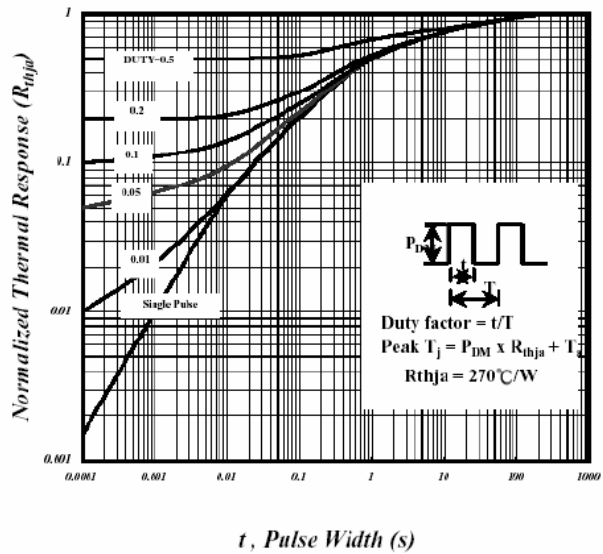

Fig10. Effective Transient Thermal Impedance

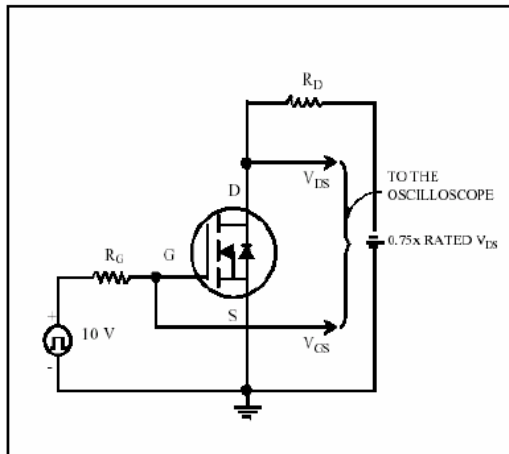

Fig 11. Switching Time Circuit

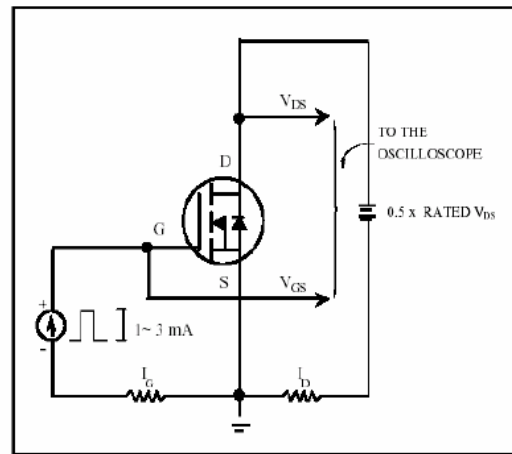

Fig 12. Gate Charge Circuit

N-Channel Enhancement Mode Power Mosfet

BL2306

PACKAGE OUTLINE

Plastic surface mounted package

SOT-23

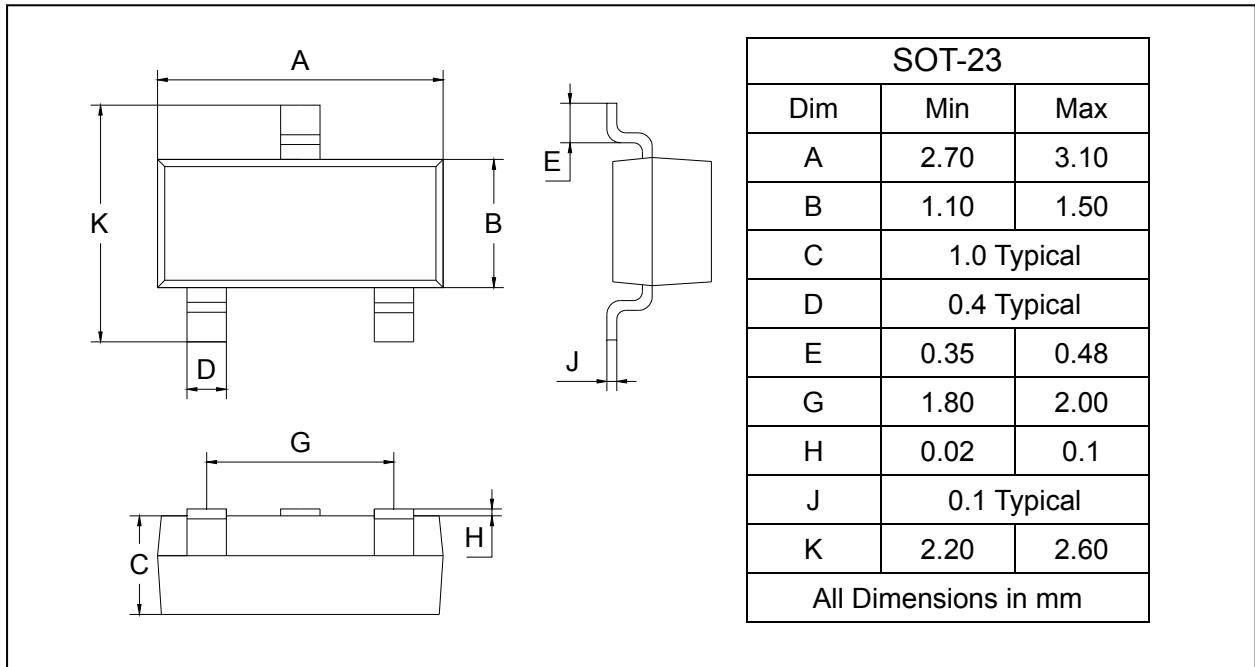

SOLDERING FOOTPRINT

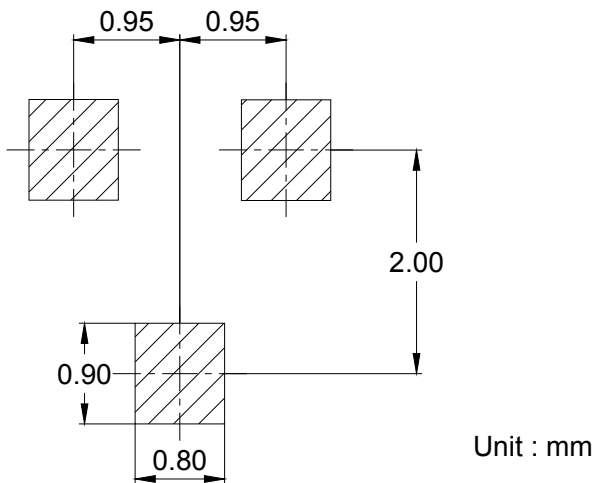

PACKAGE INFORMATION

Device	Package	Shipping
BL2306	SOT-23	3000/Tape&Reel