



400 MHz – 4 GHz Low Noise Amplifier

ADL5523

Preliminary Technical Data

FEATURES

- 17.5 dB Gain at 1950MHz
- Matched 50-Ω input and output
- Noise Figure of 1.0 dB 1950MHz
- OIP3 of 33.7dBm typ at 1950MHz
- Single 5V Supply Operation
- Operating current of 65ma at +5V
- LFCSP 3x3 mm Package

GENERAL DESCRIPTION

The ADL5523 is a high performance GaAs pHEMT low-noise amplifier. It provides high gain and low noise figure for single down-conversion IF sampling receiver architectures as well as direct down conversion receivers.

The ADL5523 amplifier comes in a compact, thermally enhanced 3x3mm LFCSP package and operates over the temperature range of -40°C to +85°C.

FUNCTIONAL BLOCK DIAGRAM

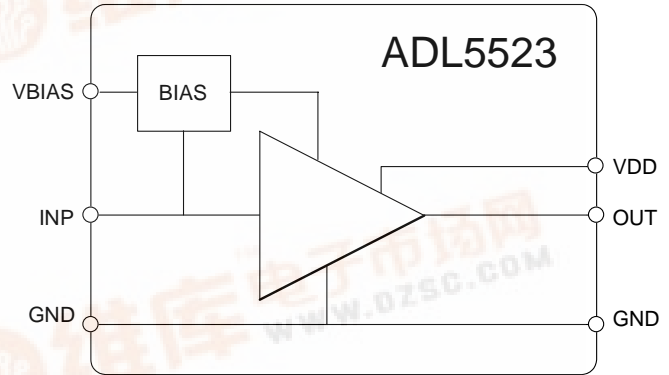

Figure 1.



SPECIFICATIONS

$V_s = 5\text{ V}$, $T = 25^\circ\text{C}$, $Z_s = Z_L = 50\Omega$, $f_C = 1950\text{MHz}$

Table 1.

Parameter	Conditions	Min	Typ	Max	Unit
Input return loss	External match		14		dB
Output return loss	External match		13		dB
Gain			17.5		dB
Gain Flatness	In the [1920 – 1980] frequency band		0.015		dB/MHz
Gain Tempco	In the [1920 – 1980] frequency band		0.011		dB/°C
Noise Figure			1.0		dB
Output IP3			33.7		dBm
Output 1 dB Compression Point			21.9		dBm
S12 Isolation			22		dB
POWER-INTERFACE					
Supply Voltage		4.5	5	5.5	V
Current Consumption			65		mA

ABSOLUTE MAXIMUM RATINGS

Table 2.

Parameter	Rating
Supply Voltage, V_{POS}	5.5 V
Max RF Input Level	TBD
Internal Power Dissipation	TBD mW
θ_{JA} (Exposed paddle soldered down)	TBD mW
θ_{JA} (Exposed paddle not soldered down)	TBD°C/W
θ_{JC} (At exposed paddle)	TBD°C/W
Maximum Junction Temperature	TBD°C/W
Operating Temperature Range	TBD°C
Storage Temperature Range	-40°C to +85°C
Lead Temperature Range (Soldering 60 sec)	-65°C to +150°C

Stresses above those listed under Absolute Maximum Ratings may cause permanent damage to the device. This is a stress rating only; functional operation of the device at these or any other conditions above those listed in the operational sections of this specification is not implied. Exposure to absolute maximum rating conditions for extended periods may affect device reliability.

ESD CAUTION

ESD (electrostatic discharge) sensitive device. Electrostatic charges as high as 4000 V readily accumulate on the human body and test equipment and can discharge without detection. Although this product features proprietary ESD protection circuitry, permanent damage may occur on devices subjected to high energy electrostatic discharges. Therefore, proper ESD precautions are recommended to avoid performance degradation or loss of functionality.



PIN CONFIGURATION AND FUNCTIONAL DESCRIPTIONS

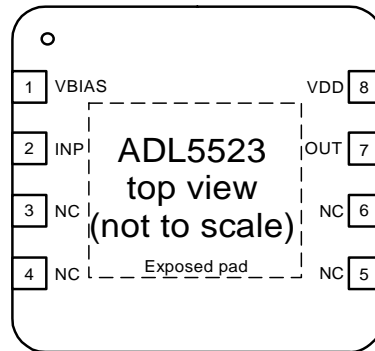

Figure 2. 8-Lead LFCSP

Table 3. Pin Function Descriptions- 8 Lead CSP

Pin No.	Mnemonic	Description
1	VBIAS	Bias: Internal DC bias
2	INP	RF Input: Must be AC-coupled.
3,4,5,6	NC	NC: No internal connection
7	OUT	RF Output: Must be AC-coupled.
8	VDD	Supply: VDD bias needs to be bypassed to ground using low-inductance capacitors.
Exposed pad	EP	Exposed Paddle: Connect to a low impedance ground plane

TYPICAL PERFORMANCE CHARACTERISTICS

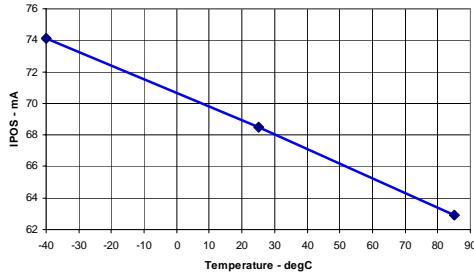

Figure 3. ADL5523 Current vs. Temperature

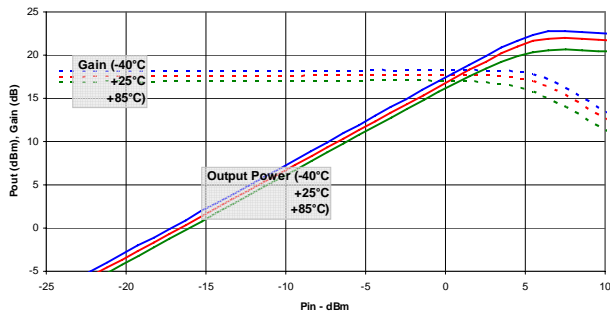

Figure 4. Output Power and Gain vs. Temperature

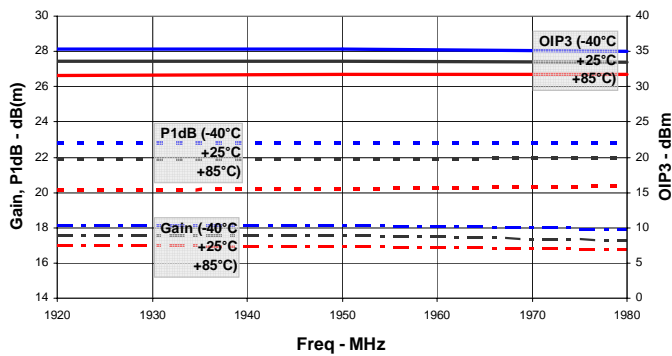

Figure 5. Gain, P1dB, OIP3 vs. Frequency

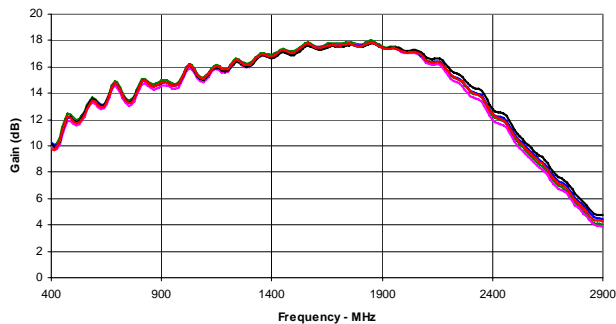

Figure 6. Gain vs. Frequency, Complete Frequency Range, 5 Parts

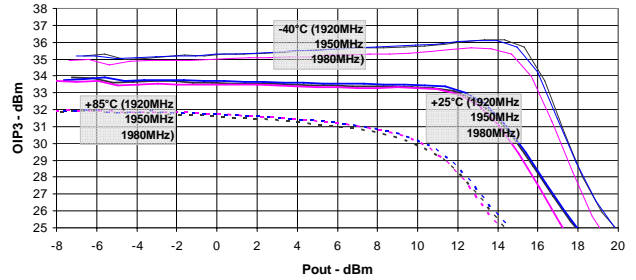

Figure 7. OIP3 vs. Output Power, Temperature and Frequency

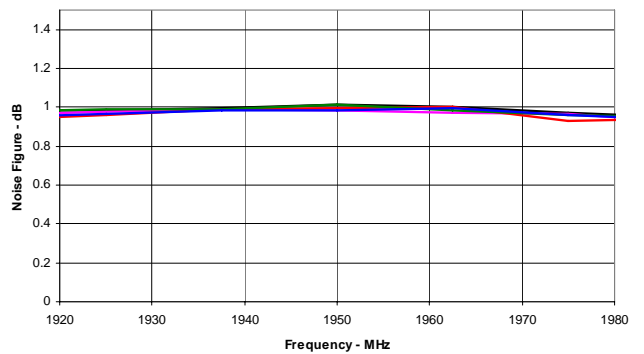

Figure 8. Distribution of Noise Figure for Five Parts, 1920 to 1980 MHz

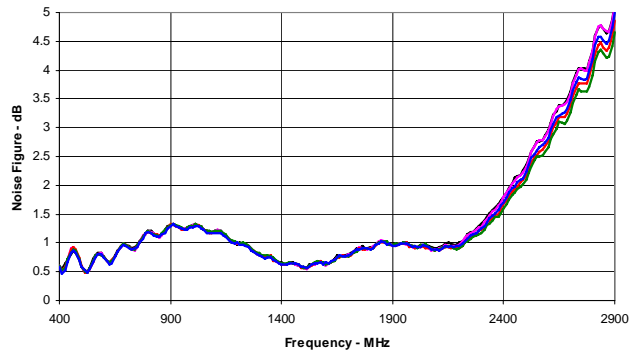

Figure 9. Distribution of Noise Figure for Five Parts, Complete Frequency Range

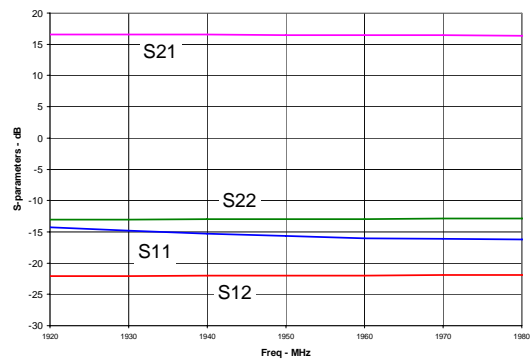

Figure 10. Typical S Parameters, 1920 to 1980 MHz

OUTLINE DIMENSIONS

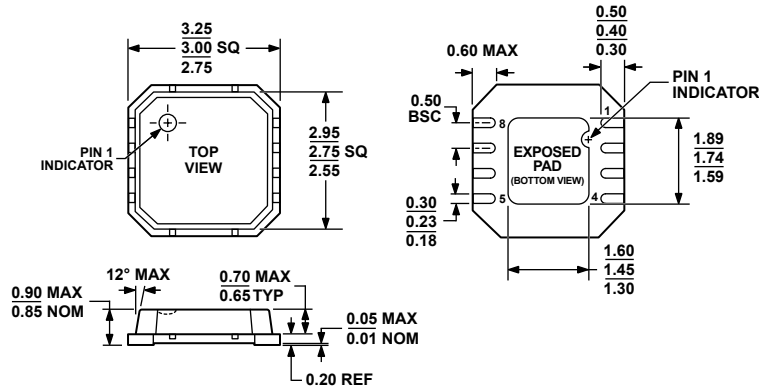

Figure 3. 8-Lead Lead Frame Chip Scale Package [LFCSP_VD]
 3mm x 3mm Body, Very Thin, Dual Lead
 CP-8-2
 Dimensions shown in millimeters

022107-A

ORDERING GUIDE

Model	Temperature Range	Package Description	Package Option
ADL5523ACPZ-R7 ¹	-40°C to +85°C	7" Tape and Reel	CP-8-2
ADL5523ACPZ-WP ¹	-40°C to +85°C	Waffle Pack	CP-8-2
ADL5523-EVALZ		Evaluation Board	

¹ Z = Pb free part