



Micropower, Rail-to-Rail I/O, High Linearity Amplifiers

Preliminary Technical Data

AD8506

FEATURES

High linearity

PSRR: 105dB minimum

CMRR: 105 dB typical

Very low supply current: 20 μ A/amp maximum

1.8 V to 5.5 V single-supply operation

Rail-to-rail input and output

Low noise 2.9 μ V p-p from 0.1 Hz to 10 Hz

4 mV offset voltage maximum

Very low input bias current: 1 pA typical

APPLICATIONS

Pressure and position sensors

Remote security

Medical monitors

Battery-powered consumer equipment

Hazard detectors

GENERAL DESCRIPTION

The AD8506 is a dual micro-power amplifier featuring rail-to-rail input and output swings while operating from a 1.8 V to 5.5 V single power supply.

Employing a new circuit technology, these low cost amplifiers offer high linearity (excellent PSRR and CMRR performance) and very low bias current, while operating with a supply current of less than 20 μ A per amplifier.

This combination of features makes the AD8506 amplifier an ideal choice for battery-powered applications since it minimizes errors due to power supply voltage variations over the battery's lifetime and maintains relatively high CMRR for a rail-to-rail op amp.

Remote battery-powered sensors, handheld instrumentation and consumer equipment, hazard detection (for example, smoke, fire, and gas), and patient monitors can benefit from the features of the AD8506 amplifier.

The AD8506 is specified for both the industrial temperature range (-40°C to $+85^{\circ}\text{C}$) and the extended industrial temperature range (-40°C to $+125^{\circ}\text{C}$). AD8506 dual amplifiers are available in the standard 8-lead MSOP and WLCSP.

PIN CONFIGURATIONS

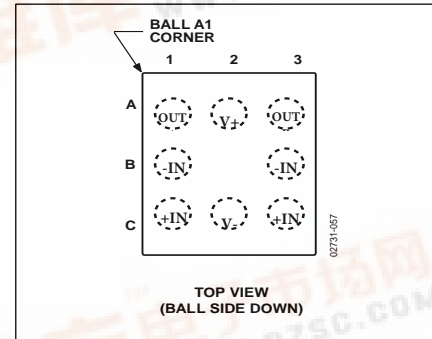

Figure 1. 8-Ball WLCSP

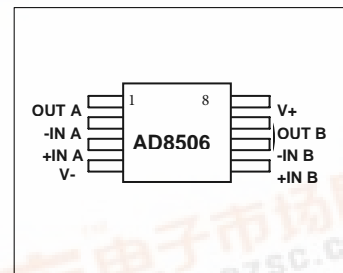

Figure 2. 8-Lead MSOP (RM Suffix)



TABLE OF CONTENTS

Features	1	Thermal Resistance	5
Applications.....	1	ESD Caution.....	5
General Description	1	Typical Performance Characteristics	6
Pin Configurations	1	Terminology	7
Revision History	2	Theory of Operation	8
Specifications.....	3	Applications Information	9
Electrical Characteristics – $V_S = 5V$	3	Outline Dimensions	10
Electrical Characteristics – $V_S = 1.8V$	4	Ordering Guide	10
Absolute Maximum Ratings.....	5		

REVISION HISTORY**10/07—Revision 0: Initial Version**

SPECIFICATIONS

ELECTRICAL CHARACTERISTICS – $V_S = 5V$

$V_S = 5V$, $V_{CM} = V_S/2$, $T_A = 25^\circ C$, unless otherwise specified.

Table 1.

Parameter	Symbol	Conditions	Min	Typ	Max	Unit
INPUT CHARACTERISTICS						
Offset Voltage	V_{OS}	$0V < V_{CM} < 5V$			4	mV
Input Bias Current	I_B	$-40^\circ C < T_A < +85^\circ C$		1	10	pA
		$-40^\circ C < T_A < +125^\circ C$			100	pA
Input Offset Current	I_{OS}	$-40^\circ C < T_A < +85^\circ C$		0.5	5	pA
		$-40^\circ C < T_A < +125^\circ C$			50	pA
Input Voltage Range		$-40^\circ C < T_A < +125^\circ C$	0		5	V
Common-Mode Rejection Ratio	CMRR	$V_{CM} = 0V$ to $5V$	90	105		dB
		$-40^\circ C < T_A < +85^\circ C$	90	105		dB
		$-40^\circ C < T_A < +125^\circ C$	90			dB
Large Signal Voltage Gain	A_{VO}	$0.05 < V_{OUT} < 4.95$	110	130		dB
		$-40^\circ C < T_A < +85^\circ C$	100			dB
		$-40^\circ C < T_A < +125^\circ C$	100			dB
Offset Voltage Drift	$\Delta V_{OS}/\Delta T$	$-40^\circ C < T_A < +85^\circ C$		2.2		$\mu V/^\circ C$
		$-40^\circ C < T_A < +125^\circ C$		2.2		$\mu V/^\circ C$
OUTPUT CHARACTERISTICS						
Output Voltage High	V_{OH}	$R_L = 100k\Omega$ to GND	4.95	4.99		V
		$R_L = 10k\Omega$ to GND	4.85	4.9		V
Output Voltage Low	V_{OL}	$R_L = 100k\Omega$ to V_S		2	50	mV
		$R_L = 10k\Omega$ to V_S		8	150	mV
Short Circuit Limit	I_{SC}	$-40^\circ C$ to $+85^\circ C$			± 60	mA
		$-40^\circ C$ to $+125^\circ C$			± 80	mA
					TBD	mA
POWER SUPPLY						
Power Supply Rejection Ratio	PSRR	$V_S = 1.8V$ to $5V$	105	120		dB
		$-40^\circ C$ to $+85^\circ C$	100	120		dB
		$-40^\circ C$ to $+125^\circ C$	90	120		dB
Supply Current/Amplifier	I_{SY}	$V_O = V_S/2$		18	20	μA
		$-40^\circ C < T_A < +125^\circ C$			28	μA
DYNAMIC PERFORMANCE						
Slew Rate	SR			12		mV/ μs
Gain Bandwidth Product	GBP			150		kHz
NOISE PERFORMANCE						
Peak-to-Peak Noise	$e_{n,p-p}$	$f = 0.1$ to $10Hz$		2.9		μV p-p
Voltage Noise Density	e_n	$f = 1kHz$		48		nV/ \sqrt{Hz}
Current Noise Density	i_n	$f = 10Hz$		TBD		fA/ \sqrt{Hz}

ELECTRICAL CHARACTERISTICS – $V_S = 1.8V$

$V_S = 1.8V$, $V_{CM} = V_S/2$, $T_A = 25^\circ C$, unless otherwise specified.

Table 2.

Parameter	Symbol	Conditions	Min	Typ	Max	Unit
INPUT CHARACTERISTICS						
Offset Voltage	V_{OS}	$0V < V_{CM} < 1.8V$			4	mV
Input Bias Current	I_B	$-40^\circ C < T_A < +85^\circ C$		1	10	pA
		$-40^\circ C < T_A < +125^\circ C$			100	pA
Input Offset Current	I_{OS}	$-40^\circ C < T_A < +85^\circ C$		0.5	5	pA
		$-40^\circ C < T_A < +125^\circ C$			50	pA
Input Voltage Range		$-40^\circ C < T_A < +125^\circ C$	0		5	V
Common-Mode Rejection Ratio	CMRR	$V_{CM} = 0V$ to $1.8V$	90	105		dB
		$-40^\circ C < T_A < +85^\circ C$	85	100		dB
		$-40^\circ C < T_A < +125^\circ C$	85			dB
Large Signal Voltage Gain	A_{VO}	$0.05 < V_{OUT} < 1.75$	110	130		dB
		$-40^\circ C < T_A < +85^\circ C$	100			dB
Offset Voltage Drift	$\Delta V_{OS}/\Delta T$	$-40^\circ C < T_A < +85^\circ C$		2.2		$\mu V/^\circ C$
		$-40^\circ C < T_A < +125^\circ C$		2.2		$\mu V/^\circ C$
OUTPUT CHARACTERISTICS						
Output Voltage High	V_{OH}	$R_L = 100k\Omega$ to GND	1.75	TBD		V
Output Voltage Low	V_{OL}	$R_L = 10k\Omega$ to GND	1.65	1.7		V
		$R_L = 100k\Omega$ to V_S		TBD	50	mV
Short Circuit Limit	I_{SC}	$R_L = 10k\Omega$ to V_S		TBD	150	mV
		$-40^\circ C$ to $+85^\circ C$		± 4		mA
		$-40^\circ C$ to $+125^\circ C$			± 6	mA
					TBD	mA
POWER SUPPLY						
Power Supply Rejection Ratio	PSRR	$V_S = 1.8V$ to $5V$	105	120		dB
		$-40^\circ C$ to $+85^\circ C$	100	120		dB
Supply Current/Amplifier	I_{SY}	$-40^\circ C$ to $+125^\circ C$	90	120		μA
		$V_O = V_S/2$		18	20	μA
		$-40^\circ C < T_A < +125^\circ C$			28	μA
DYNAMIC PERFORMANCE						
Slew Rate	SR			12		mV/ μs
Gain Bandwidth Product	GBP			150		kHz
NOISE PERFORMANCE						
Peak-to-Peak Noise	$e_{n,p-p}$	$f = 0.1$ to $10Hz$		2.9		μV p-p
Voltage Noise Density	e_n	$f = 1kHz$		48		nV/ \sqrt{Hz}
Current Noise Density	i_n	$f = 10Hz$		TBD		fA/ \sqrt{Hz}

ABSOLUTE MAXIMUM RATINGS

Table 3.

Parameter	Rating
Supply Voltage	6 V
Input Voltage	$\pm V_s$
Differential Input Voltage ¹	$\pm V_s$
Output Short-Circuit Duration to Gnd	Indefinite
Storage Temperature Range RM, CB Packages	-65°C to +150°C
Operating Temperature Range	-40°C to +125°C
Junction Temperature Range RM, CB Packages	-65°C to +150°C
Lead Temperature (Soldering, 60 sec)	300°C

¹ Differential input voltage is limited to 5 V or the supply voltage, whichever is less.

Stresses above those listed under Absolute Maximum Ratings may cause permanent damage to the device. This is a stress rating only; functional operation of the device at these or any other conditions above those indicated in the operational section of this specification is not implied. Exposure to absolute maximum rating conditions for extended periods may affect device reliability.

THERMAL RESISTANCE

θ_{JA} is specified for the worst-case conditions, that is, a device soldered in a circuit board for surface-mount packages.

Table 4. Thermal Resistance

Package Type	θ_{JA}	θ_{JC}	Unit
8-Lead MSOP (RM)	190	44	°C/W
8-Ball WLCSP	TBD	TBD	°C/W

ESD CAUTION



ESD (electrostatic discharge) sensitive device. Charged devices and circuit boards can discharge without detection. Although this product features patented or proprietary protection circuitry, damage may occur on devices subjected to high energy ESD. Therefore, proper ESD precautions should be taken to avoid performance degradation or loss of functionality.

TYPICAL PERFORMANCE CHARACTERISTICS

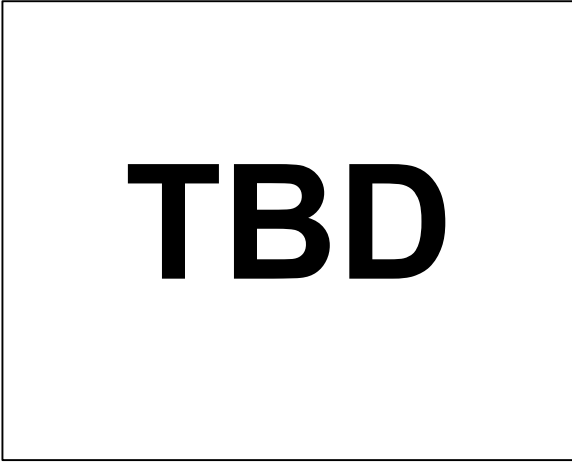

Figure 3

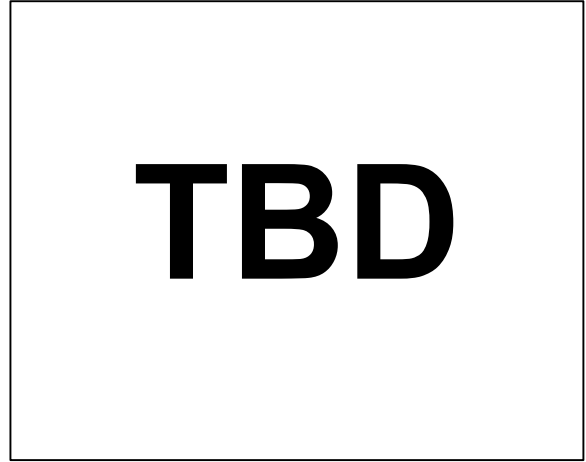

Figure 6

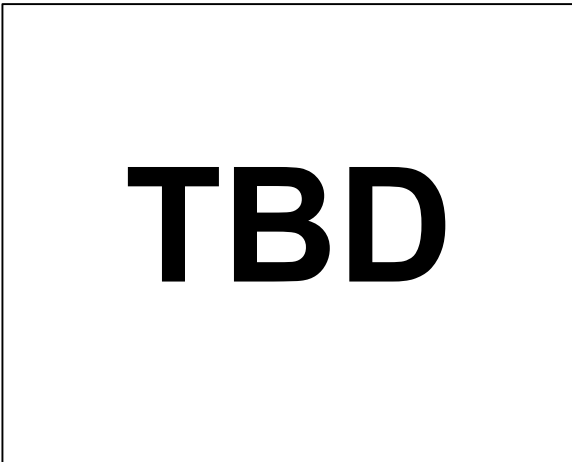

Figure 4

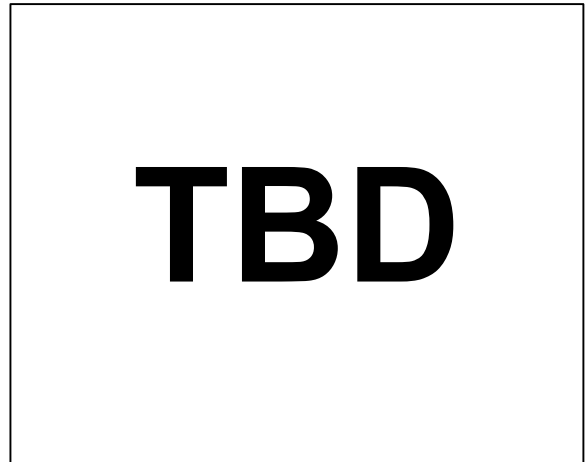

Figure 7

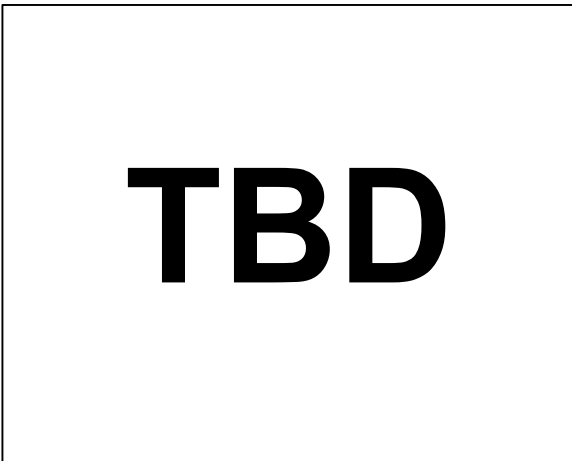

Figure 5

TERMINOLOGY

Definition Term
Definition

Definition Term
Definition

Definition Term
Definition

Definition Term
Definition

Definition Term
Definition

Definition Term
Definition

THEORY OF OPERATION

APPLICATIONS INFORMATION

OUTLINE DIMENSIONS

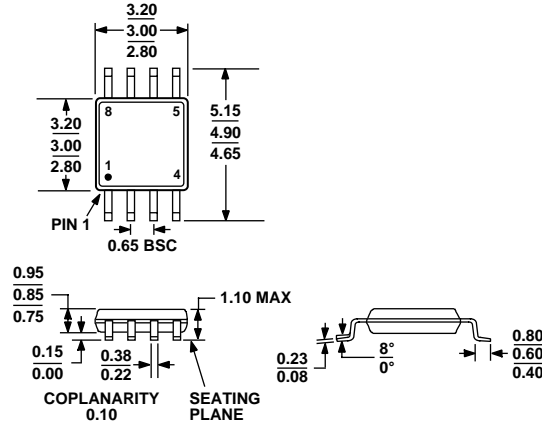

COMPLIANT TO JEDEC STANDARDS MO-187-AA

Figure 8. 8-Lead Mini Small Outline Package [MSOP] (RM-8)

Dimensions shown in millimeters

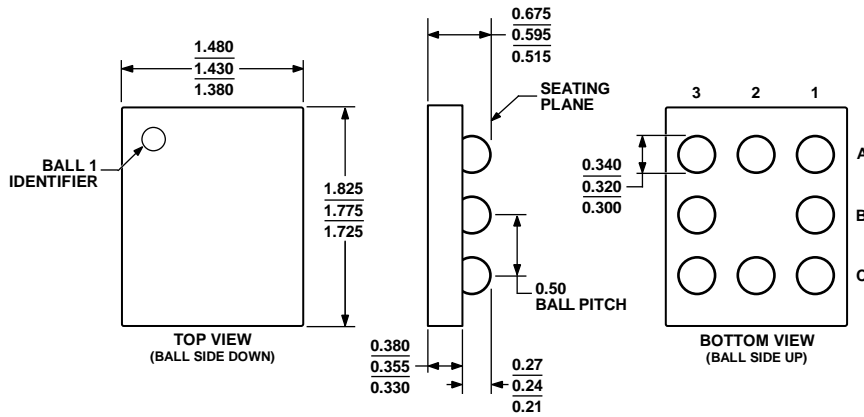

Figure 9. 8-Ball Wafer Level Chip Scale Package [WLCSP] (CB-8-1)

Dimensions shown in millimeters

090706-B

ORDERING GUIDE

Model	Temperature Range	Package Description	Package Option
AD8506ARMZ ¹	-40°C to +125°C	8-Lead Mini Small Outline Package [MSOP]	RM-8
AD8506ACBZ ¹	-40°C to +125°C	8-Ball Wafer Level Chip Scale Package [WLCSP]	CB-8-1

¹ Z = RoHS Compliant Part.