

HSDL-4270

High-Performance T-1 $\frac{3}{4}$ (5mm) AlGaAs Infrared (940nm) Lamp



Datasheet

Description

The HSDL-4270 Infrared emitter was designed for applications that require high power and low forward voltage. It utilizes Aluminum Gallium Arsenide (AlGaAs) LED technology and is optimized for efficiency at emission wavelengths of 940 nm. The material used produces high radiant efficiency over a wide range of currents. The emitter is packaged in clear T-1 $\frac{3}{4}$ (5mm) package.

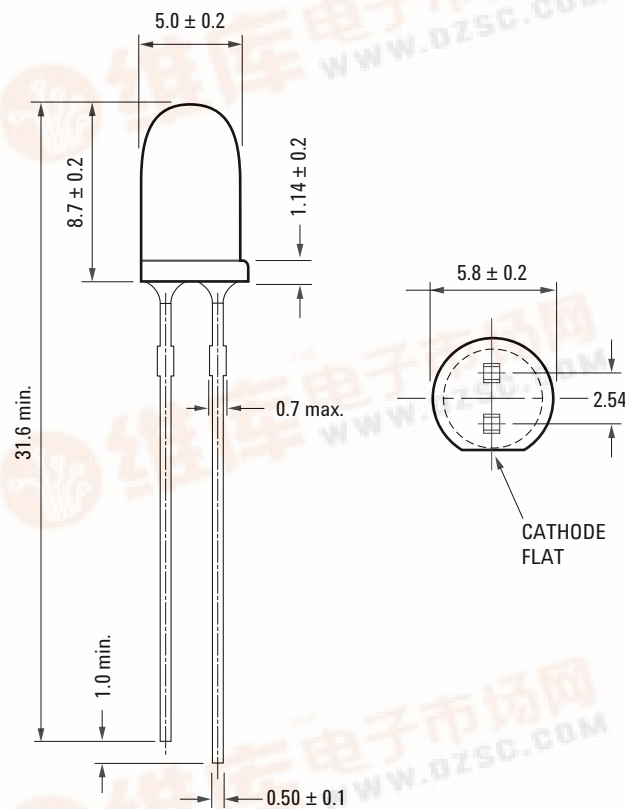

Features

- High Power AlGaAs LED Technology
- 940 nm Wavelength
- T-1 $\frac{3}{4}$ Package
- Low Cost
- Low Forward Voltage: 1.3V at 20mA

Applications

- Industrial Infrared Equipments and Applications (Smoke Detectors etc)
- Consumer Electronics (Infrared Remote Controller etc)
- Infrared spotlight for cameras
- Discrete Interrupters
- Infrared source for optical counters and card readers

Part Number	Lead Form	Shipping Option
HSDL-4270	Straight	Bulk



Absolute Maximum Ratings at 25°C

Parameter	Symbol	Minimum	Maximum	Unit	Reference
Peak Forward Current	I_{FPK}	-	500	mA	Figure 3 Duty cycle = 20% Pulse Width = 100us
Forward Current	I_{FDC}	-	100	mA	[1]
Power Dissipation	P_{DISS}	-	170	mW	
Reverse Voltage	V_R	5	-	V	$I_R=100\mu A$
Storage Temperature	T_S	-40	100	°C	
LED Junction Temperature	T_J		110	°C	
Lead Soldering Temperature			260 for 5 sec	°C	

Notes:

1. Derate as shown in Figure 6.

Recommended Operating Conditions

Parameter	Symbol	Min	Max	Unit	Reference
Operating Temperature	T_0	-40	85	°C	

Electrical Characteristics at 25°C

Parameter	Symbol	Min.	Typ.	Max.	Unit	Condition	Reference
Forward Voltage	V_F	-	1.3 1.5	1.4 1.7	V	$I_{FDC}=20mA$ $I_{FDC}=100mA$	Figure 2 Figure 3
Forward Voltage Temperature Coefficient	$\Delta V/\Delta T$	-	-1.4	-	mV/°C	$I_{FDC}=100mA$	Figure 4
Series Resistance	R_S	-	3.0	-	Ohms	$I_{FDC}=100mA$	
Diode Capacitance	C_0	-	27	-	pF	$V_{bias}=0V$, $f=1MHz$	
Thermal Resistance, Junction to Ambient	$R\theta_{ja}$	-	300	-	°C/W		

Optical Characteristics at 25°C

Parameter	Symbol	Min.	Typ.	Max.	Unit	Condition	Reference
Radiant On-Axis Intensity	I_E	76	100	-	mW/Sr	$I_{FDC}=100mA$	Figure 5
Radiant On-Axis Intensity Temperature Coefficient	$\Delta I_E/\Delta T$	-	-0.48	-	%/°C	$I_{FDC}=100mA$	
Viewing Angle	$2\theta_{1/2}$	-	15	-	°		Figure 7
Peak Wavelength	λ_{pk}	-	940	-	nm		Figure 1
Peak wavelength Temperature Coefficient	$\Delta\lambda/\Delta T$	-	0.26	-	nm/°C	$I_{FDC}=100mA$	
Spectral Width	$\Delta\lambda$		45	-	nm	$I_{FDC}=20mA$	Figure 1
Optical Rise and Fall Time	t_r/t_f		1.3	-	μs	$I_{FDC}=100mA$ Duty Ratio = 50% Pulse Width=10 μs	

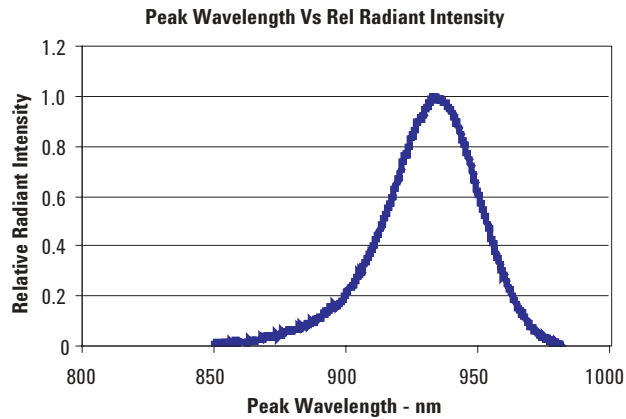

Figure 1. Relative Radiant Intensity vs. Wavelength

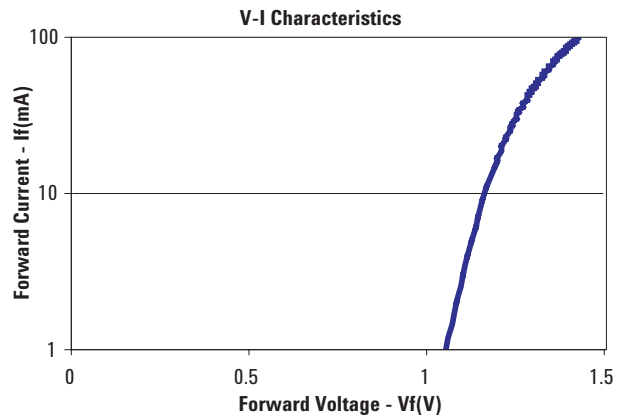

Figure 2. DC Forward Current vs. Forward Voltage

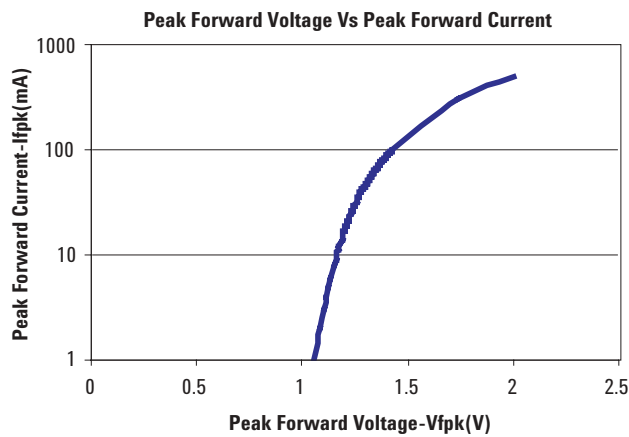

Figure 3. Peak Forward Current vs. Forward Voltage

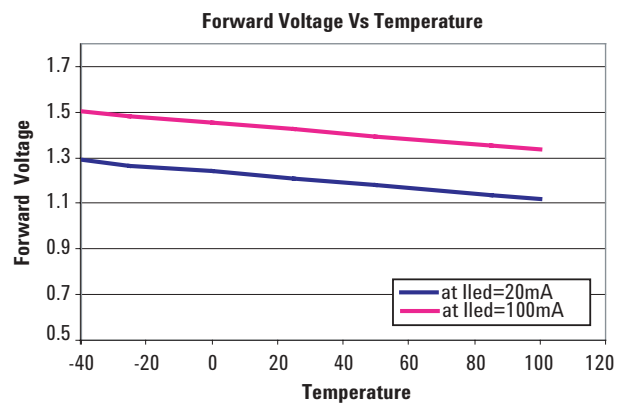

Figure 4. Forward Voltage vs. Ambient Temperature

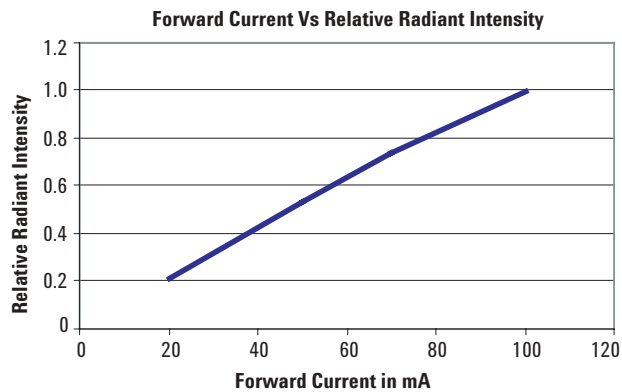

Figure 5. Relative Radiant Intensity vs. DC Forward Current

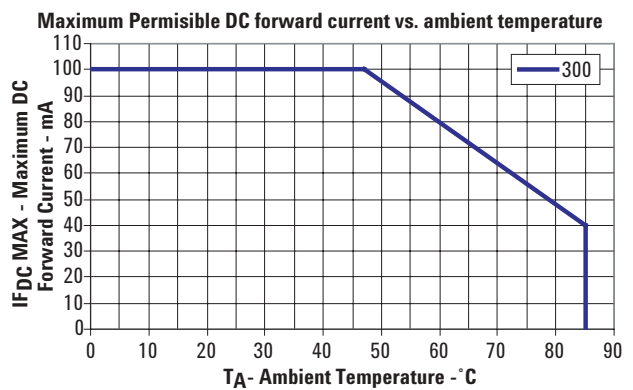

Figure 6. DC Forward Current vs. Ambient Temperature Derated Based on $T_{JMAX}=110^{\circ}C$

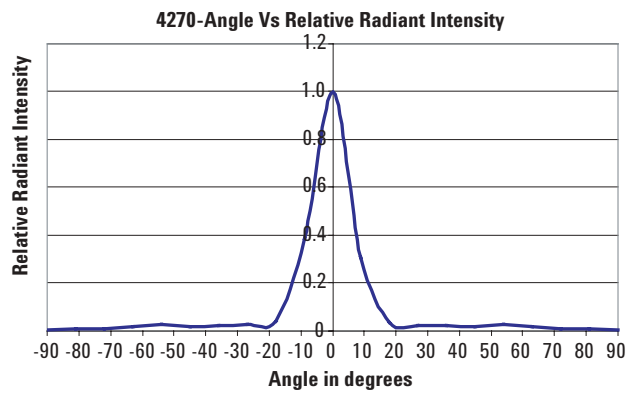
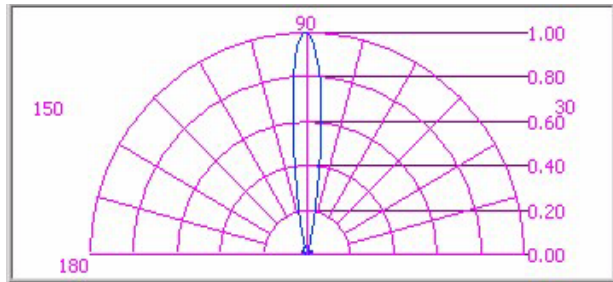

Figure 7. Radiant Intensity vs. Angular Displacement

For product information and a complete list of distributors, please go to our web site: www.avagotech.com

Avago, Avago Technologies, and the A logo are trademarks of Avago Technologies, Pte. in the United States and other countries. Data subject to change. Copyright © 2006 Avago Technologies Pte. All rights reserved.
5989-4469EN - January3, 2006

