

HSMF-C114

Surface Mount Tricolor ChipLEDs



Data Sheet

Description

The HSMF-C114 tricolor chip-type LED is designed in an ultra small package for miniaturization. It is the first of its kind to achieve such small packaging and be the thinnest package in the industry for tricolor package. With the freedom to have any combination of colors from mixing of the 3 primary colors, this will yield a wide variety of colors to suit every application and product theme.

The small size, narrow footprint, and low profile make this LED excellent for back-lighting, status indication, and front panel illumination applications.

In order to facilitate pick and place operation, this ChipLED is shipped in tape and reel, with 4000 units per reel. The package is compatible with reflow soldering and binned by both color and intensity.

Features

- Common anode
- Small 1.6 x 1.5 x 0.35 mm package
- Diffused optics
- Red/Green/Blue color combination
- Available in 8 mm tape on 7" diameter reels
- High brightness using AlInGaP and InGaN die technology
- Compatible with reflow soldering

Applications

- Backlighting
- Status indicator
- Front panel indicator
- Office automation, home appliances, industrial equipment

CAUTION: HSMF-C114 LEDs are Class 1A ESD sensitive per JESD22-A114C.01. Please observe appropriate precautions during handling and processing. Refer to Application Note AN-1142 for additional details.

Package Dimensions

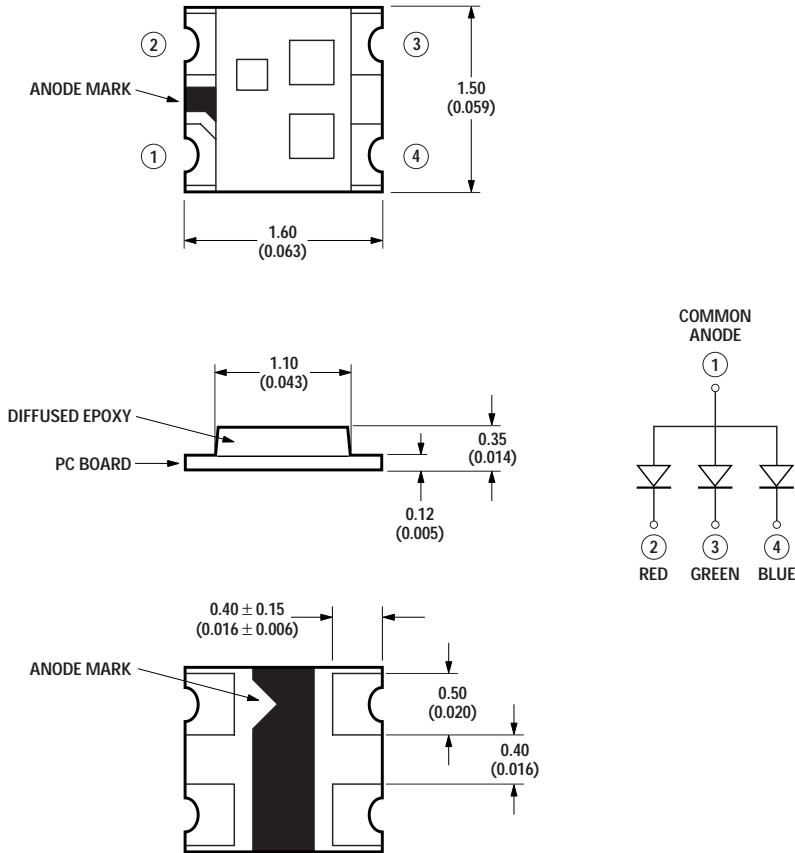

- NOTES:
1. ALL DIMENSIONS IN MILLIMETERS (INCHES).
 2. TOLERANCE IS ± 0.1 mm (± 0.004 IN.) UNLESS OTHERWISE SPECIFIED.

Absolute Maximum Ratings at $T_A = 25^\circ\text{C}$

Parameter	AllInGaP Red	InGaN Green	InGaN Blue	Units
DC Forward Current ^[1,3]	20	20	20	mA
Power Dissipation ^[1]	48	78	78	mW
DC Forward Current ^[2]	15	15	15	mA
Power Dissipation ^[2]	36	59	59	mW
Reverse Voltage ($I_R = 100 \mu\text{A}$)	5	5	5	V
LED Junction Temperature	95	95	95	$^\circ\text{C}$
Operating Temperature Range		-30 to 85		$^\circ\text{C}$
Storage Temperature Range		-40 to 85		$^\circ\text{C}$
Soldering Temperature	See reflow soldering profile (Figures 7 & 8)			

Notes:

1. Applies when single LED is lit up.
2. Applies when all 3 LEDs are lit up simultaneously.
3. Derate linearly as shown in Figure 4.
4. Drive currents above 5 mA are recommended for best long term performance.

Electrical Characteristics at $T_A = 25^\circ\text{C}$

Part Number	Forward Voltage V_F (Volts) ^[1] @ $I_F = 20\text{ mA}$		Reverse Breakdown V_R (Volts) @ $I_R = 100\ \mu\text{A}$ Min.	Capacitance C (pF), @ $V_F = 0$, $f = 1\text{ MHz}$ Typ.
	Typ.	Max.		
AllnGaP Red	1.9	2.4	5	10
InGaN Green	3.4	3.9	5	65
InGaN Blue	3.4	3.9	5	65

Note:

1. V_F tolerance: $\pm 0.1\text{ V}$.

Optical Characteristics at $T_A = 25^\circ\text{C}$

Part Number	Luminous Intensity I_V ^[1] (mcd) @ 20 mA		Peak Wavelength λ_{peak} (nm) Typical	Color, Dominant Wavelength λ_d ^[2] (nm) Typical	Viewing Angle $2\theta_{1/2}$ ^[3] (Degrees) Typical	Luminous Efficacy η_v (lm/W) Typical
	Min.	Typ.				
AllnGaP Red	28.5	150.0	637	626	100	155
InGaN Green	45.0	180.0	523	525	145	477
InGaN Blue	28.5	70.0	468	470	145	75

Notes:

1. The luminous intensity I_V is measured at the peak of the spatial radiation pattern which may not be aligned with the mechanical axis of the LED package.
2. The dominant wavelength, λ_d , is derived from the CIE Chromaticity Diagram and represents the perceived color of the device.
3. $\theta_{1/2}$ is the off-axis angle where the luminous intensity is 1/2 the peak intensity.

CAUTION:

1. The above optical performance specifications are valid in the case when single LED is lit up.
2. The above product specifications DO NOT provide any guarantee on color mixing, color consistency over time, or uniformity in luminous intensity when more than 1 LED is lit.
3. Please refer to Avago Technologies' *Application Brief AB D-007* for additional details/explanation on driving the part in parallel circuit.

Light Intensity (I_V) Bin Limits^[1]

Bin ID	Intensity (mcd)	
	Minimum	Maximum
A	0.11	0.18
B	0.18	0.29
C	0.29	0.45
D	0.45	0.72
E	0.72	1.10
F	1.10	1.80
G	1.80	2.80
H	2.80	4.50
J	4.50	7.20
K	7.20	11.20
L	11.20	18.00
M	18.00	28.50
N	28.50	45.00
P	45.00	71.50
Q	71.50	112.50
R	112.50	180.00
S	180.00	285.00
T	285.00	450.00

Tolerance: $\pm 15\%$

Note:

- Bin categories are established for classification of products. Products may not be available in all categories. Please contact your Avago representative for information on current available bins.

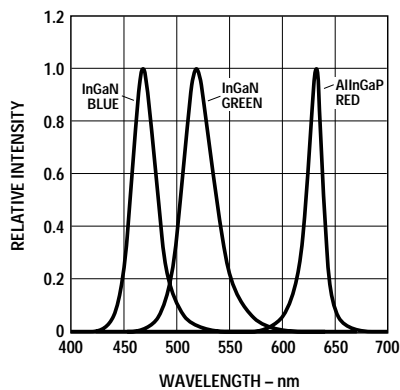

Figure 1. Relative intensity vs. wavelength.

AllInGaP Red Color Bin Limits^[1]

Bin ID	Dom. Wavelength (nm)	
	Minimum	Maximum
—	620.0	635.0

Tolerance: ± 1 nm

InGaN Green Color Bin Limits^[1]

Bin ID	Dom. Wavelength (nm)	
	Minimum	Maximum
A	515.0	520.0
B	520.0	525.0
C	525.0	530.0
D	530.0	535.0

Tolerance: ± 1 nm

InGaN Blue Color Bin Limits^[1]

Bin ID	Dom. Wavelength (nm)	
	Minimum	Maximum
A	460.0	465.0
B	465.0	470.0
C	470.0	475.0
D	475.0	480.0

Tolerance: ± 1 nm

Note:

- Bin categories are established for classification of products. Products may not be available in all categories. Please contact your Avago representative for information on current available bins.

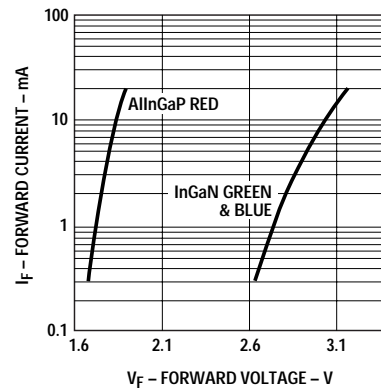

Figure 2. Forward current vs. forward voltage. Luminous intensity vs. forward current.

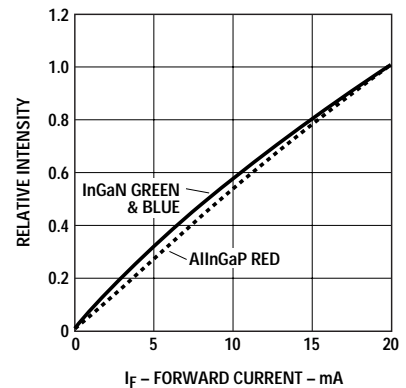

Figure 3. Luminous intensity vs. forward current.

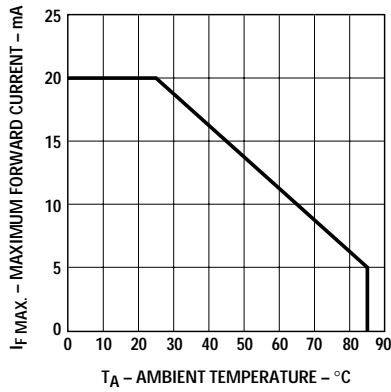

Figure 4. Maximum forward current vs. ambient temperature.

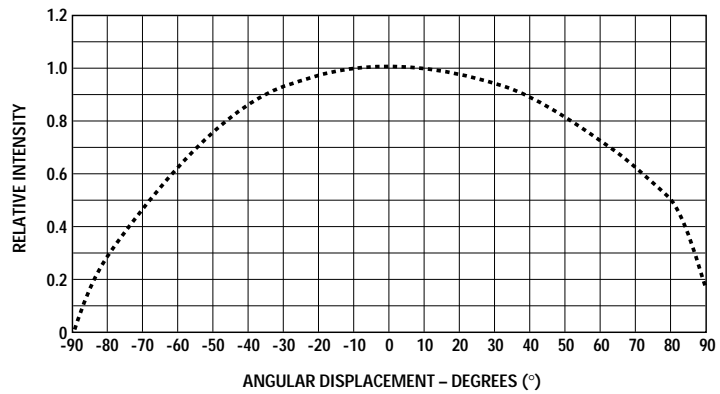

Figure 5. Relative intensity vs. angle (AlInGaP RED).

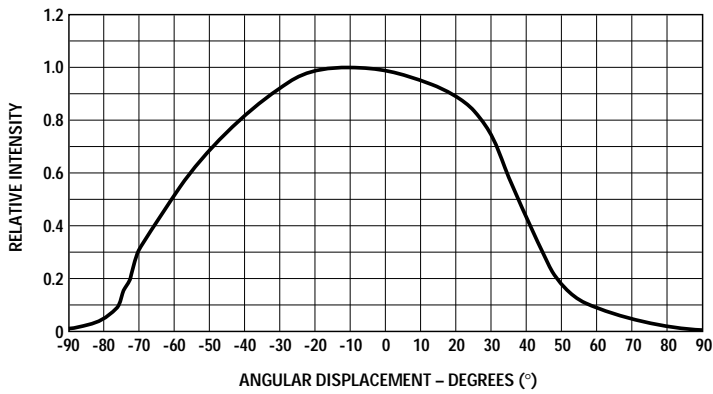

Figure 6. Relative intensity vs. angle (InGaN GREEN and BLUE).

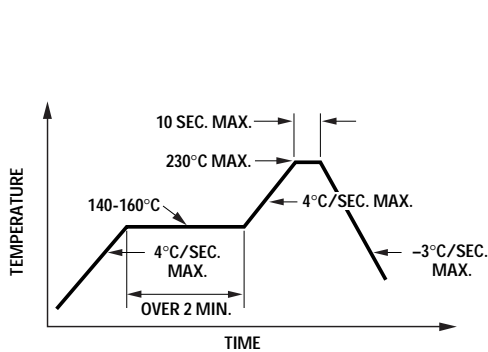

Figure 7. Recommended reflow soldering profile.

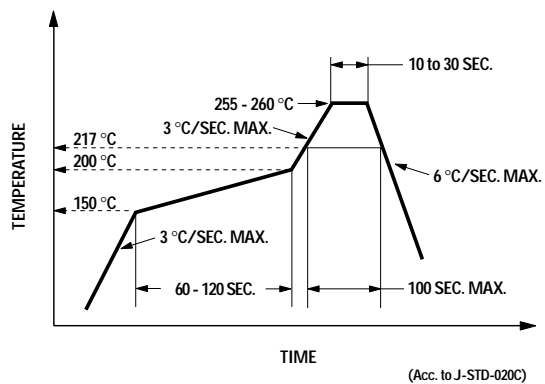

Figure 8. Recommended Pb-free reflow soldering profile.

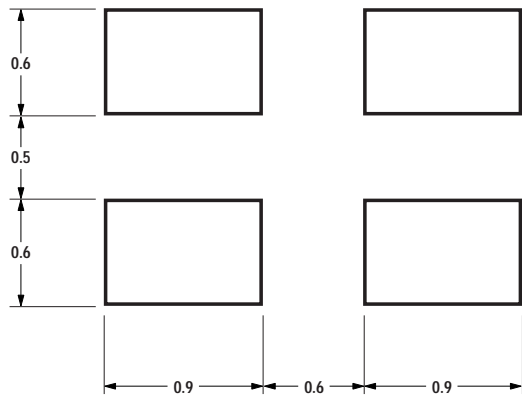

Figure 9. Recommended soldering land pattern.

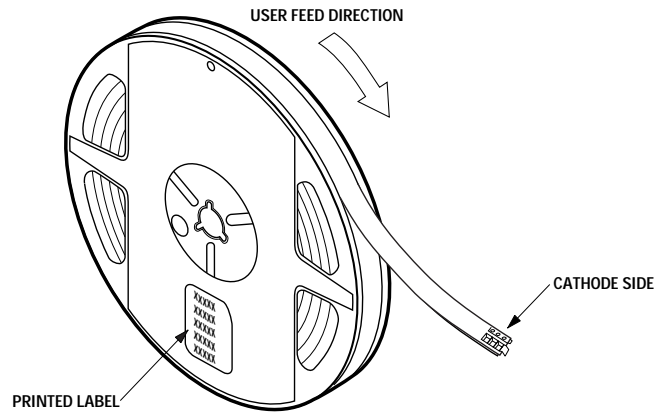
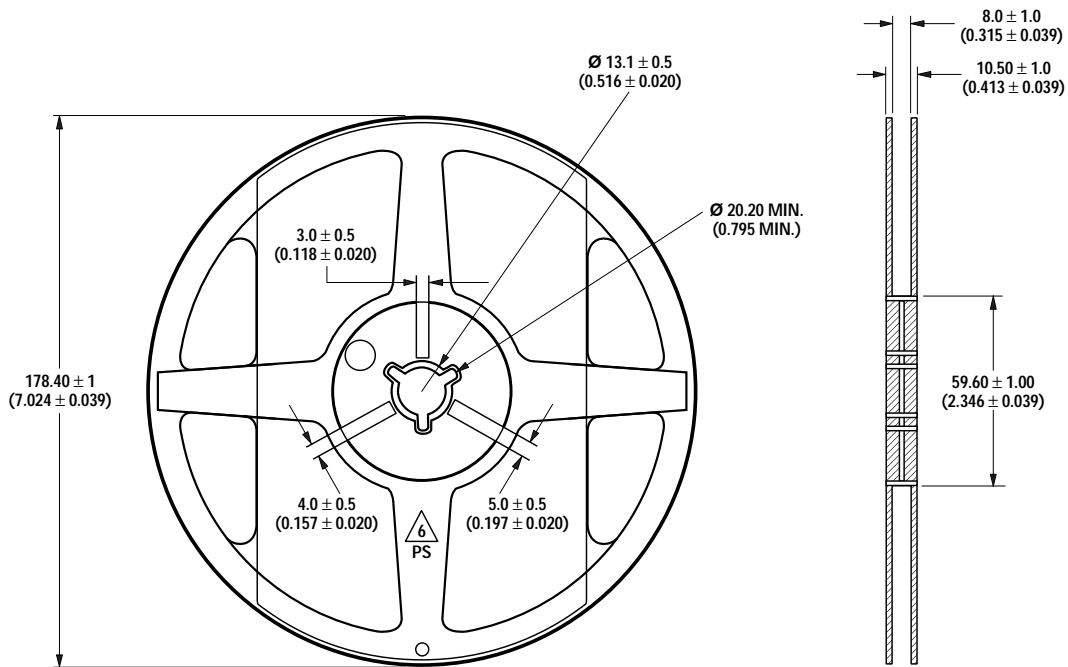

Figure 10. Reeling orientation.



NOTE:
1. ALL DIMENSIONS IN MILLIMETERS (INCHES).

Figure 11. Reel dimensions.

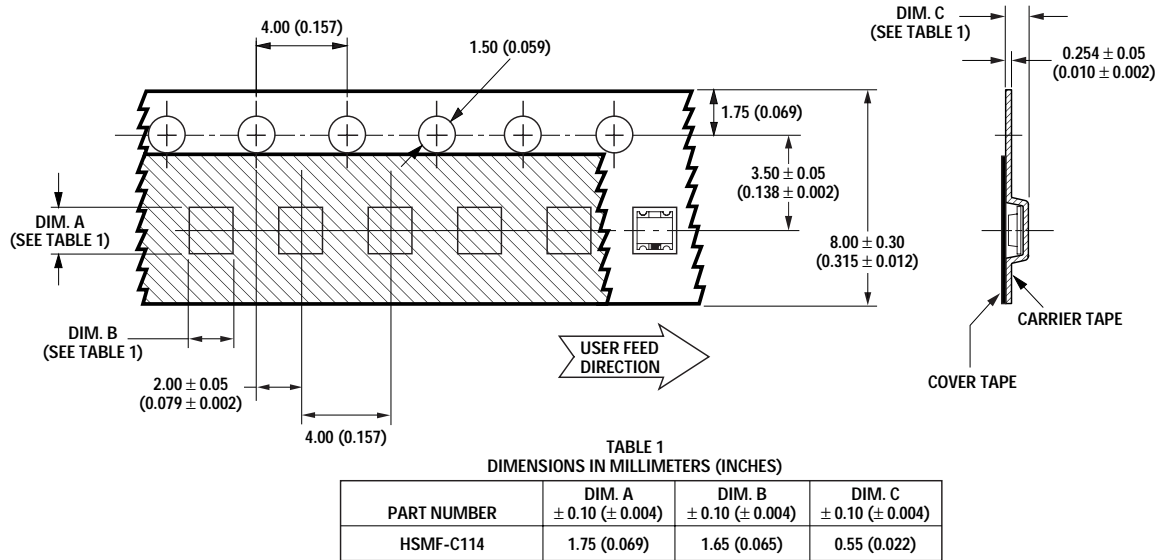

Figure 12. Tape dimensions.

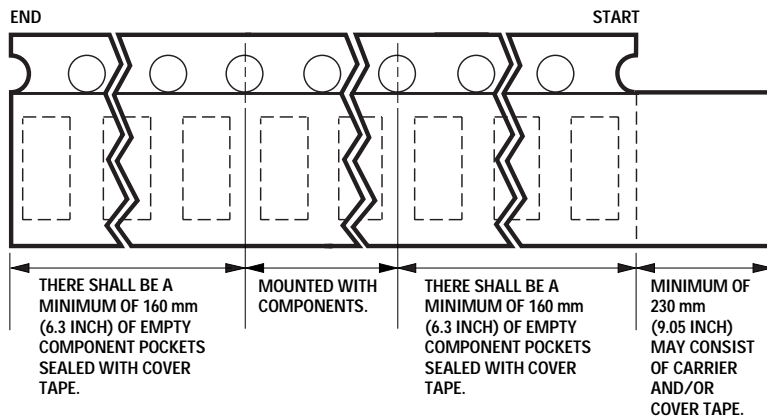

Figure 13. Tape leader and trailer dimensions.

Convective IR Reflow Soldering

For more information on reflow soldering, refer to Application Note 1060, *Surface Mounting SMT LED Indicator Components*.

Storage Condition:

5 to 30 °C @ 60% RH max.

Baking is required before mounting if:

1. Humidity Indicator Card is > 10% when read at $23 \pm 5^\circ\text{C}$.
2. Device exposed to factory conditions < 30°C/60% RH more than 672 hours.

Recommended baking condition:

$60 \pm 5^\circ\text{C}$ for 20 hours.

For product information and a complete list of distributors, please go to our website: www.avagotech.com

Avago, Avago Technologies, and the A logo are trademarks of Avago Technologies Limited in the United States and other countries. Data subject to change. Copyright © 2006 Avago Technologies Pte. All rights reserved. Obsoletes 5989-3351EN 5989-4809EN October 17, 2006

Avago
TECHNOLOGIES