



查询TSL237T供应商

TAOS TEXAS
ADVANCED
OPTOELECTRONIC
SOLUTIONS®

捷多邦, 专业PCB打样工厂, 24小时加急出货

TSL237T
HIGH-SENSITIVITY
LIGHT-TO-FREQUENCY CONVERTER

TAOS055G – JUNE 2007

- High-Resolution Conversion of Light Intensity to Frequency With No External Components
- High Irradiance Responsivity . . .
1.2 kHz/($\mu\text{W}/\text{cm}^2$) at $\lambda_p = 640 \text{ nm}$
- Low Dark Frequency . . . < 2 Hz at 50° C
- Single-Supply Operation . . . 2.7 V to 5.5 V
- Stable 200 ppm/°C Temperature Coefficient
- Communicates Directly with a Microcontroller
- RoHS Compliant

PACKAGE T
4-LEAD SMD
(TOP VIEW)

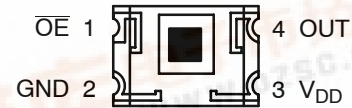

Description

The TSL237T light-to-frequency converter combines a silicon photodiode and a current-to-frequency converter on a single monolithic CMOS integrated circuit. Output is a square wave (50% duty cycle) with frequency directly proportional to light intensity (irradiance) on the photodiode. The digital output allows direct interface to a microcontroller or other logic circuitry. Output enable ($\overline{\text{OE}}$) places the output in a high-impedance state for multiple-unit sharing of a microcontroller input line. The device has been temperature compensated for the ultraviolet-to-visible light range of 320 nm to 700 nm and responds over the light range of 320 nm to 1050 nm. The TSL237T is characterized for operation over the temperature range of -40°C to 85°C and is supplied in a compact 4-lead surface-mount package.

Functional Block Diagram

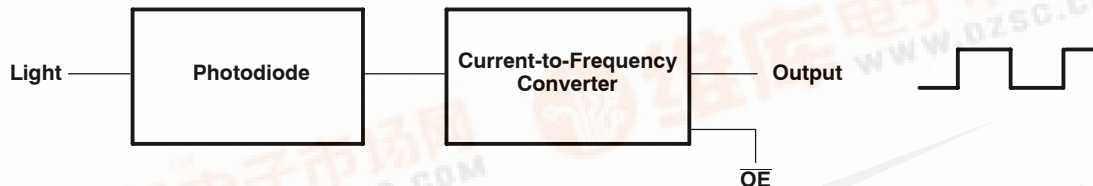

Available Options

DEVICE	T _A	PACKAGE – LEADS	PACKAGE DESIGNATOR	ORDERING NUMBER
TSL237T	-40°C to 85°	4-lead Low Profile Surface Mount	T	TSL237T

Terminal Functions

TERMINAL NAME	T PKG NO.	TYPE	DESCRIPTION
GND	2		Power supply ground (substrate). All voltages are referenced to GND.
$\overline{\text{OE}}$	1	I	Enable for f_O (active low).
OUT	4	O	Output frequency.
V _{DD}	3		Supply voltage.



LUMINOLOGY® Company

Texas Advanced Optoelectronic Solutions Inc.

1001 Klein Road • Suite 200 • Plano, TX 75074 • (972) 672-0750

Copyright © 2007, TAOS Inc.

TSL237T HIGH-SENSITIVITY LIGHT-TO-FREQUENCY CONVERTER

TAOS055G – JUNE 2007

Absolute Maximum Ratings over operating free-air temperature range (unless otherwise noted)[†]

Supply voltage, V_{DD} (see Note 1)	6 V
Input voltage range, \overline{OE} input, V_I	-0.3 V to $V_{DD} + 0.3$ V
Operating free-air temperature range, T_A	-40°C to 85°C
Storage temperature range, T_{stg}	-40°C to 85°C
Solder conditions in accordance with JEDEC J-STD-020A, maximum temperature	260°C

[†] Stresses beyond those listed under “absolute maximum ratings” may cause permanent damage to the device. These are stress ratings only, and functional operation of the device at these or any other conditions beyond those indicated under “recommended operating conditions” is not implied. Exposure to absolute-maximum-rated conditions for extended periods may affect device reliability.

NOTE 1: All voltage values are with respect to GND.

Recommended Operating Conditions

		MIN	NOM	MAX	UNIT
Supply voltage, V_{DD}		2.7	5	5.5	V
High-level input voltage, V_{IH}	$V_{DD} = 5$ V	4.5		V_{DD}	V
Low-level input voltage, V_{IL}	$V_{DD} = 5$ V	0		0.5	V
Operating free-air temperature range, T_A		-40		85	°C

Electrical Characteristics at $V_{DD} = 5$ V, $T_A = 25^\circ\text{C}$ (unless otherwise noted)

PARAMETER		TEST CONDITIONS		MIN	TYP	MAX	UNIT
V_{OH}	High-level output voltage	$I_{OH} = -1$ mA		4	4.7		V
V_{OL}	Low-level output voltage	$I_{OL} = 1$ mA			0.1	0.4	V
I_{DD}	Supply current				1.6	3	mA
	Full-scale frequency [‡]			500		1000	kHz
	Temperature coefficient of output frequency	Wavelength < 700nm, $f_O = 50$ kHz			± 200		ppm/°C
k_{SVS}	Supply-voltage sensitivity	$V_{DD} = 5$ V $\pm 10\%$			± 0.5		%/V

[‡] Full-scale frequency is the maximum operating frequency of the device without saturation.

Operating Characteristics at $V_{DD} = 5$ V, $T_A = 25^\circ\text{C}$, $\lambda_p = 640$ nm (unless otherwise noted)

PARAMETER		TEST CONDITIONS		MIN	TYP	MAX	UNIT
f_O	Output frequency	$E_e = 40.4$ $\mu\text{W}/\text{cm}^2$		40	50	60	kHz
f_D	Dark frequency	$E_e = 0$ $\mu\text{W}/\text{cm}^2$		0	0.1		Hz
		$E_e = 0$ $\mu\text{W}/\text{cm}^2$, $T_A = 50^\circ\text{C}$		0		2	Hz
R_e	Irradiance responsivity				1.2		kHz/($\mu\text{W}/\text{cm}^2$)
	Nonlinearity [§]	$f_O = 0$ kHz to 10 kHz			$\pm 1\%$		%F.S.
	Step response to full-scale step input				1 pulse of new frequency plus 1 μs		

[§] Nonlinearity is defined as the deviation of f_O from a straight line between zero and full scale, expressed as a percent of full scale.

TYPICAL CHARACTERISTICS

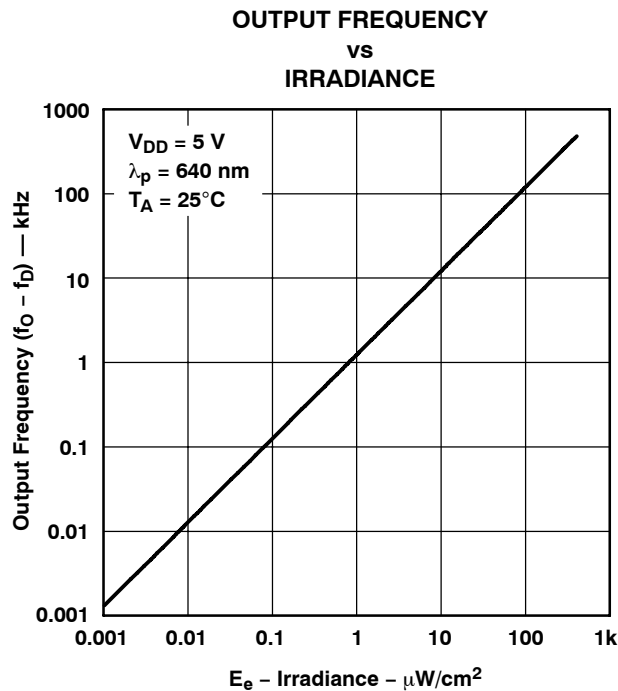

Figure 1

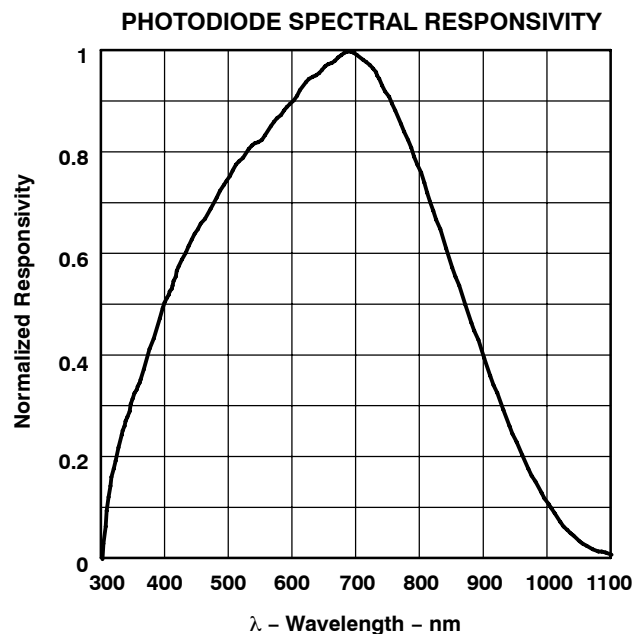

Figure 2

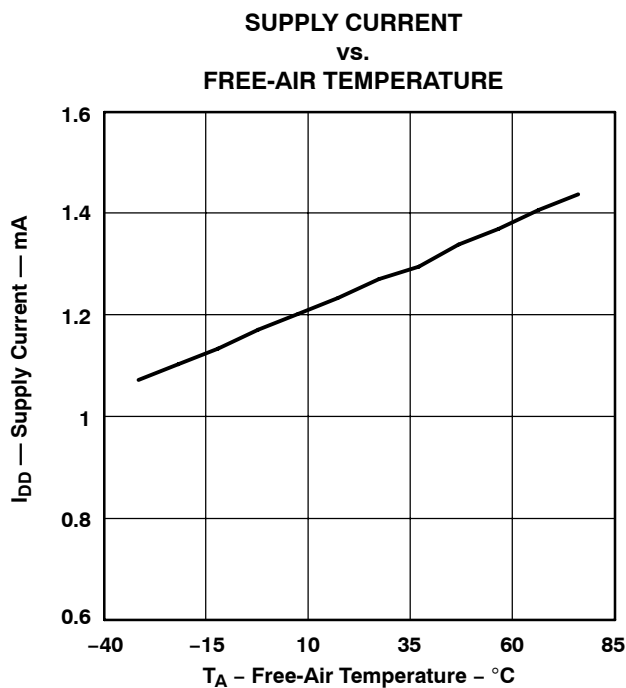

Figure 3

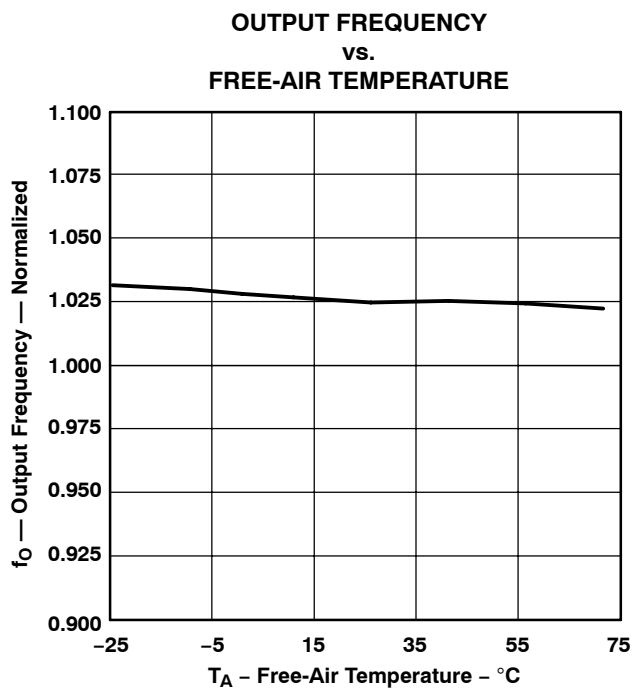

Figure 4

TYPICAL CHARACTERISTICS

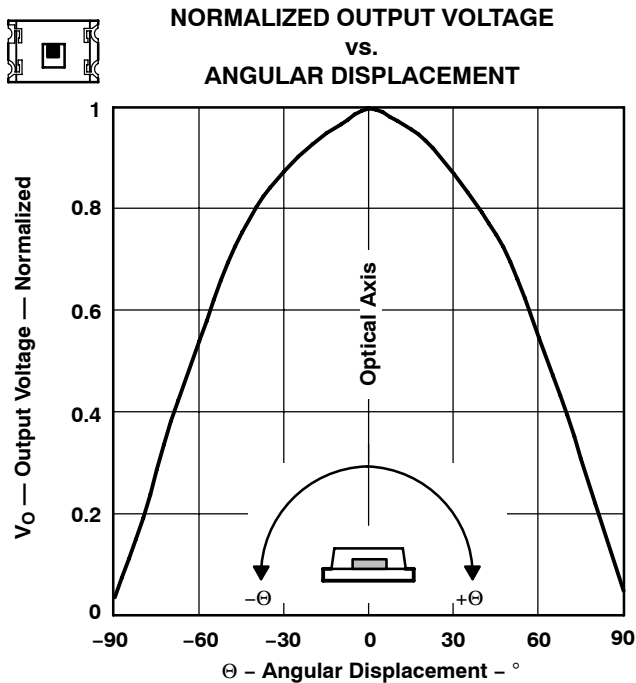

Figure 5

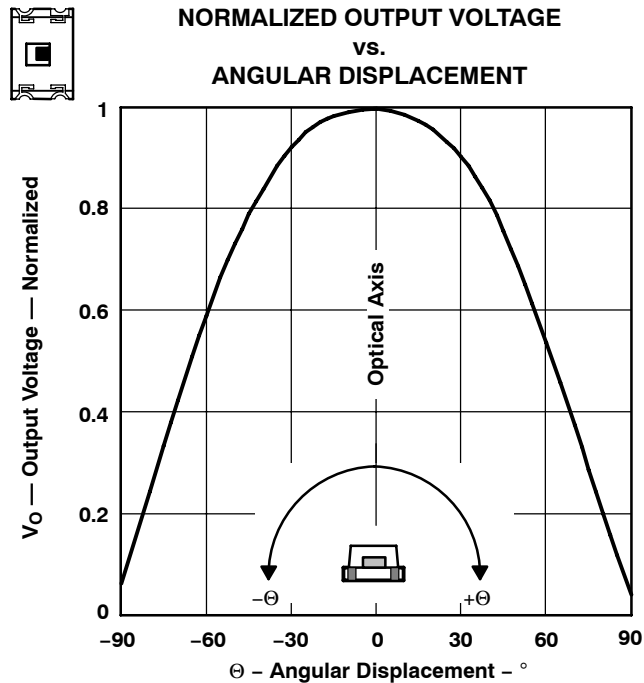

Figure 6

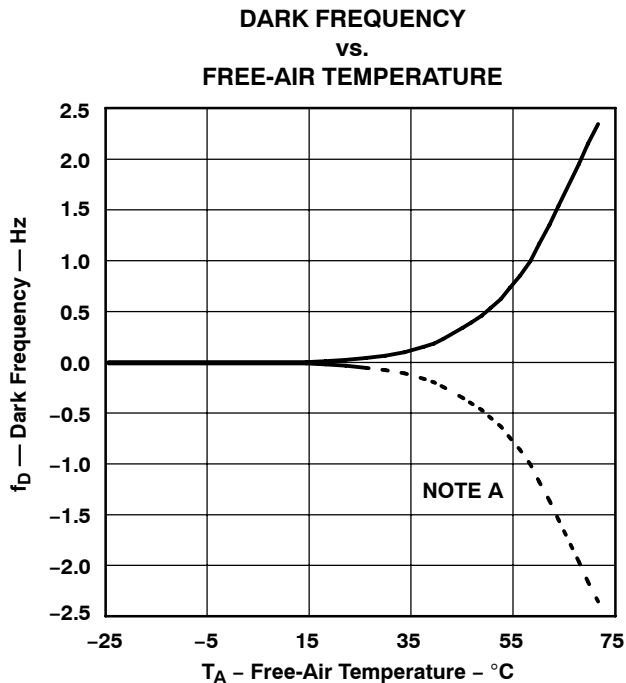

Figure 7

NOTE A: Internal offsets that result in dark frequency can be both positive and negative. The dashed line represents the case of negative offset in which an equivalent amount of light signal is required to obtain a non-zero output frequency.

APPLICATION INFORMATION

Power-Supply Considerations

Power-supply lines must be decoupled by a 0.01- μF to 0.1- μF capacitor with short leads placed close to the TSL237T (Figure 8). A low-noise power supply is required to minimize jitter on output pulse.

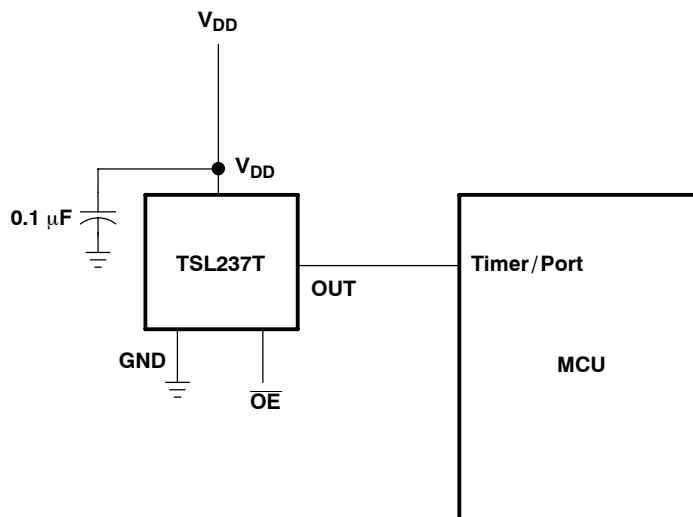

Figure 8. Typical TSL237T Interface to a Microcontroller

Device Operational Details

The frequency at the output pin (OUT) is given by:

$$f_O = f_D + (R_e) (E_e)$$

where:

- f_O is the output frequency
- f_D is the output frequency for dark condition ($E_e = 0$)
- R_e is the device responsivity for a given wavelength of light given in $\text{kHz}/(\mu\text{W}/\text{cm}^2)$
- E_e is the incident irradiance in $\mu\text{W}/\text{cm}^2$

f_D is a constant error term in the output frequency calculation resulting from leakage currents, and is independent of light intensity. The TSL237T die is trimmed to minimize the magnitude of this dark frequency component so that it can be neglected in the transfer function calculation. In many applications, measurement of the actual dark frequency may be impractical due to measurement times ranging from several seconds to several minutes, and the fact that some devices may never transition (zero dark frequency).

Input Interface

A low-impedance electrical connection between the device $\overline{\text{OE}}$ terminal and the device GND terminal is required for improved noise immunity.

Output Interface

The output of the device is designed to drive a CMOS logic input over short distances. If lines greater than 12 inches in length are used on the output, a buffer or line driver is recommended.

APPLICATION INFORMATION

Measuring the Frequency

The choice of interface and measurement technique depends on the desired resolution and data-acquisition rate. For maximum data-acquisition rate, period-measurement techniques are used.

Period measurement requires the use of a fast reference clock with available resolution directly related to the reference-clock rate. The technique is employed to measure rapidly varying light levels or to make a fast measurement of a constant light source.

Maximum resolution and accuracy may be obtained using frequency-measurement, pulse-accumulation, or integration techniques. Frequency measurements provide the added benefit of averaging out random- or high-frequency variations (jitter) resulting from noise in the light signal. Resolution is limited mainly by available counter registers and allowable measurement time. Frequency measurement is well suited for slowly varying or constant light levels and for reading average light levels over short periods of time. Integration, the accumulation of pulses over a very long period of time, can be used to measure exposure — the amount of light present in an area over a given time period.

PCB Pad Layout

Suggested PCB pad layout guidelines for the T package are shown in Figure 9.

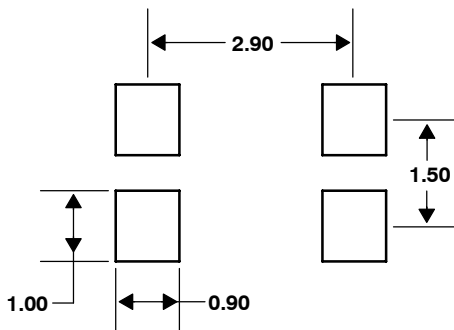

- NOTES: A. All linear dimensions are in millimeters.
B. This drawing is subject to change without notice.

Figure 9. Suggested T Package PCB Layout

MECHANICAL DATA

The TSL237T is supplied in a low-profile surface-mount package. This package contains no lead (Pb).

PACKAGE T

Four-Lead Surface Mount Device

TOP VIEW

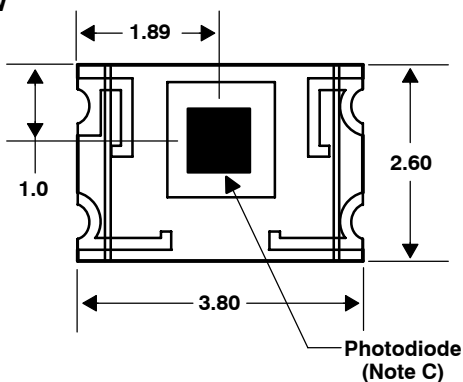

DETAIL A: TYPICAL PACKAGE TERMINAL

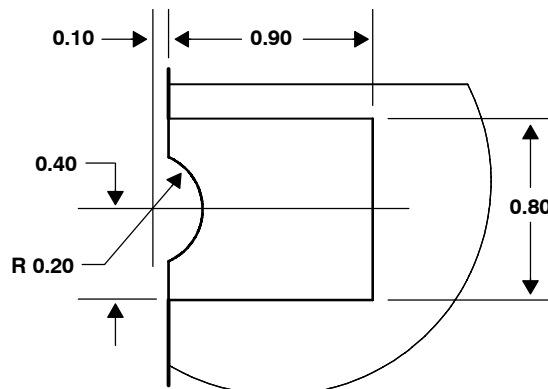

SIDE VIEW

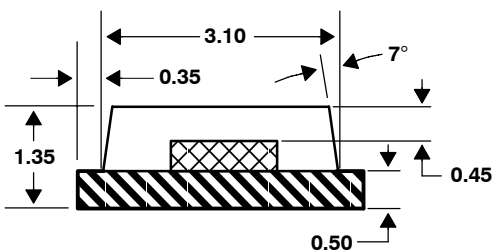

BOTTOM VIEW

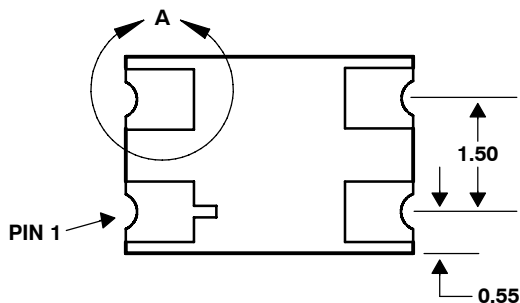

Lead Free

- NOTES: A. All linear dimensions are in millimeters.
 B. Terminal finish is gold, 1.3 μ m minimum.
 C. The center of the 0.84 mm \times 0.84 mm integrated photodiode active area is referenced to the upper left corner of the package (near Pin 1).
 D. Dimension tolerance is \pm 0.15 mm.
 E. This drawing is subject to change without notice.

Figure 10. Package T — Four-Lead Surface Mount Device Packaging Configuration

TSL237T
HIGH-SENSITIVITY
LIGHT-TO-FREQUENCY CONVERTER
 TAOS055G – JUNE 2007

MECHANICAL DATA

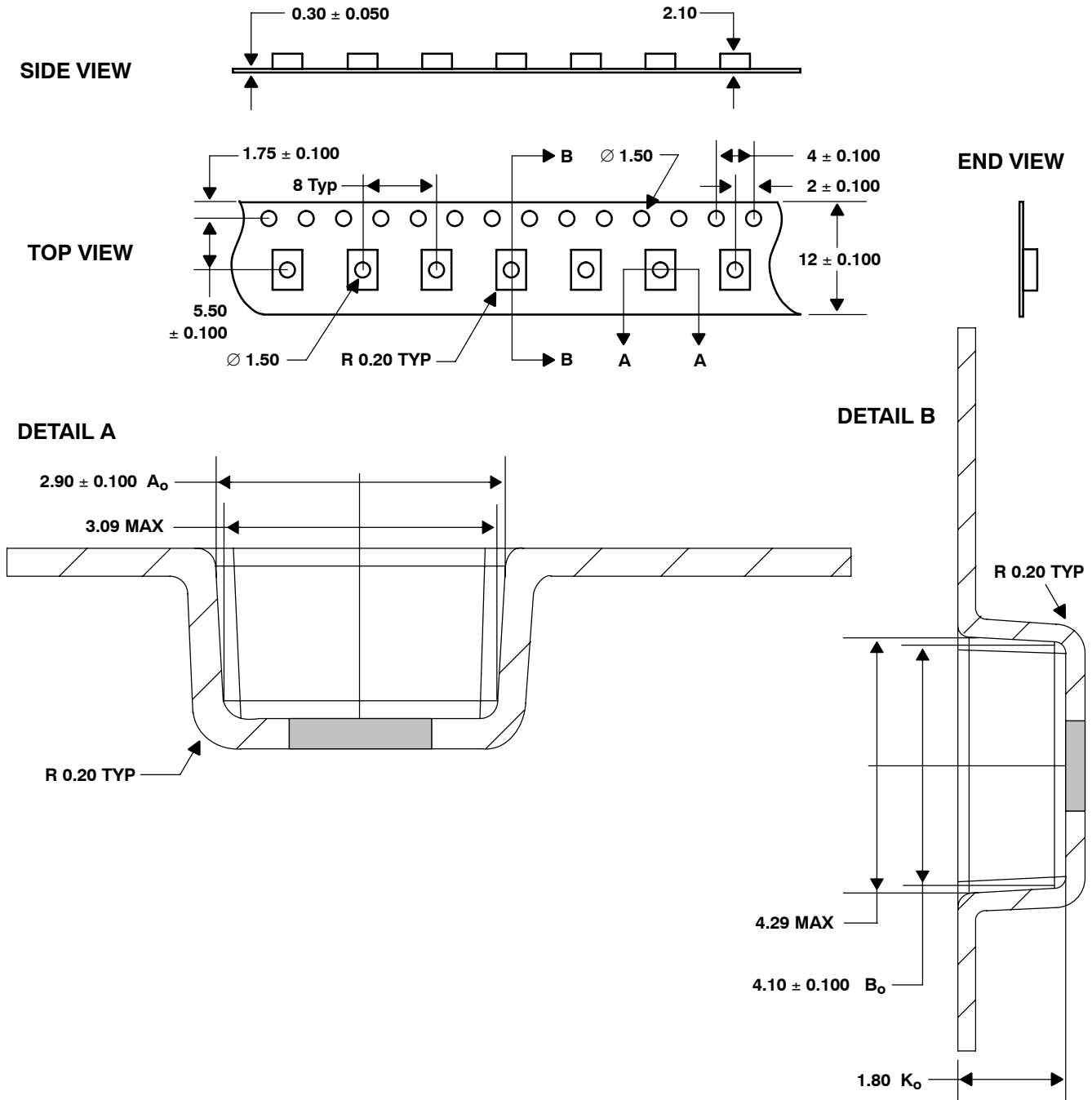

- NOTES: A. All linear dimensions are in millimeters.
 B. The dimensions on this drawing are for illustrative purposes only. Dimensions of an actual carrier may vary slightly.
 C. Symbols on drawing A_o , B_o , and K_o are defined in ANSI EIA Standard 481-B 2001.
 D. Each reel is 178 millimeters in diameter and contains 1000 parts.
 E. TAOS packaging tape and reel conform to the requirements of EIA Standard 481-B.
 F. In accordance with EIA standard, device pin 1 is located next to the sprocket holes in the tape.
 G. This drawing is subject to change without notice.

Figure 11. Four Lead Surface Mount Package Carrier Tape

MANUFACTURING INFORMATION

The reflow profile specified here describes expected maximum heat exposure of devices during the solder reflow process of the device on a PWB. Temperature is measured at the top of the device. Devices should be limited to one pass through the solder reflow profile.

Table 1. TSL237T Solder Reflow Profile

PARAMETER	REFERENCE	TSL237T
Average temperature gradient in preheating		2.5°C/sec
Soak time	t_{soak}	2 to 3 minutes
Time above T_1 , 217°C	t_1	Max 60 sec
Time above T_2 , 230°C	t_2	Max 50 sec
Time above T_3 , ($T_{peak} - 10^\circ\text{C}$)	t_3	Max 10 sec
Peak temperature in reflow	T_{peak}	260° C (-0°C/+5°C)
Temperature gradient in cooling		Max -5°C/sec

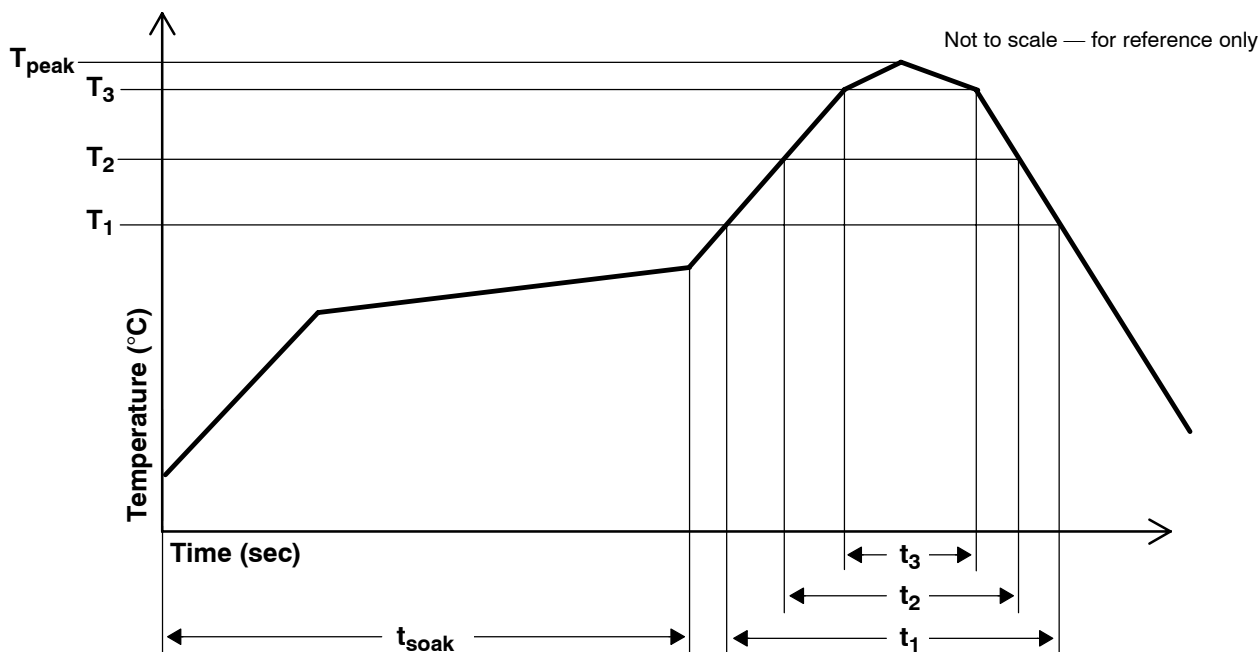

Figure 12. TSL237T Solder Reflow Profile

TSL237T
HIGH-SENSITIVITY
LIGHT-TO-FREQUENCY CONVERTER
TAOS055G – JUNE 2007

MANUFACTURING INFORMATION

Moisture Sensitivity

Optical characteristics of the device can be adversely affected during the soldering process by the release and vaporization of moisture that has been previously absorbed into the package molding compound. To ensure the package molding compound contains the smallest amount of absorbed moisture possible, each device is dry-baked prior to being packed for shipping. Devices are packed in a sealed aluminized envelope with silica gel to protect them from ambient moisture during shipping, handling, and storage before use.

This package has been assigned a moisture sensitivity level of MSL 3 and the devices should be stored under the following conditions:

Temperature Range	5°C to 50°C
Relative Humidity	60% maximum
Total Time	6 months from the date code on the aluminized envelope — if unopened
Opened Time	168 hours or fewer

Rebaking will be required if the devices have been stored unopened for more than 6 months or if the aluminized envelope has been open for more than 168 hours. If rebaking is required, it should be done at 90°C for 4 hours.

PRODUCTION DATA — information in this document is current at publication date. Products conform to specifications in accordance with the terms of Texas Advanced Optoelectronic Solutions, Inc. standard warranty. Production processing does not necessarily include testing of all parameters.

LEAD-FREE (Pb-FREE) and GREEN STATEMENT

Pb-Free (RoHS) TAOS' terms *Lead-Free* or *Pb-Free* mean semiconductor products that are compatible with the current RoHS requirements for all 6 substances, including the requirement that lead not exceed 0.1% by weight in homogeneous materials. Where designed to be soldered at high temperatures, TAOS Pb-Free products are suitable for use in specified lead-free processes.

Green (RoHS & no Sb/Br) TAOS defines *Green* to mean Pb-Free (RoHS compatible), and free of Bromine (Br) and Antimony (Sb) based flame retardants (Br or Sb do not exceed 0.1% by weight in homogeneous material).

Important Information and Disclaimer The information provided in this statement represents TAOS' knowledge and belief as of the date that it is provided. TAOS bases its knowledge and belief on information provided by third parties, and makes no representation or warranty as to the accuracy of such information. Efforts are underway to better integrate information from third parties. TAOS has taken and continues to take reasonable steps to provide representative and accurate information but may not have conducted destructive testing or chemical analysis on incoming materials and chemicals. TAOS and TAOS suppliers consider certain information to be proprietary, and thus CAS numbers and other limited information may not be available for release.

NOTICE

Texas Advanced Optoelectronic Solutions, Inc. (TAOS) reserves the right to make changes to the products contained in this document to improve performance or for any other purpose, or to discontinue them without notice. Customers are advised to contact TAOS to obtain the latest product information before placing orders or designing TAOS products into systems.

TAOS assumes no responsibility for the use of any products or circuits described in this document or customer product design, conveys no license, either expressed or implied, under any patent or other right, and makes no representation that the circuits are free of patent infringement. TAOS further makes no claim as to the suitability of its products for any particular purpose, nor does TAOS assume any liability arising out of the use of any product or circuit, and specifically disclaims any and all liability, including without limitation consequential or incidental damages.

TEXAS ADVANCED OPTOELECTRONIC SOLUTIONS, INC. PRODUCTS ARE NOT DESIGNED OR INTENDED FOR USE IN CRITICAL APPLICATIONS IN WHICH THE FAILURE OR MALFUNCTION OF THE TAOS PRODUCT MAY RESULT IN PERSONAL INJURY OR DEATH. USE OF TAOS PRODUCTS IN LIFE SUPPORT SYSTEMS IS EXPRESSLY UNAUTHORIZED AND ANY SUCH USE BY A CUSTOMER IS COMPLETELY AT THE CUSTOMER'S RISK.

LUMENOLOGY, TAOS, the TAOS logo, and Texas Advanced Optoelectronic Solutions are registered trademarks of Texas Advanced Optoelectronic Solutions Incorporated.

TSL237T
HIGH-SENSITIVITY
LIGHT-TO-FREQUENCY CONVERTER

TAOS055G – JUNE 2007
