

FAIRCHILD

A Schlumberger Company

μA715

急出货

High Speed Operational Amplifier

Linear Division Operational Amplifiers

Description

The $\mu A715$ is a high speed, high gain, monolithic operational amplifier constructed using the Fairchild Planar Epitaxial process. It is intended for use in a wide range of applications where fast signal acquisition or wide bandwidth is required. The $\mu A715$ features fast settling time, high slew rate, low offsets, and high output swing for large signal applications. In addition, the device displays excellent temperature stability and will operate over a wide range of supply voltages. The $\mu A715$ is ideally suited for use in A/D and D/A converters, active filters, deflection amplifiers, video amplifiers, phase-locked loops, multiplexed analog gates, precision comparators, sample-and-holds, and general feedback applications requiring DC wide bandwidth operation.

- **High Slew Rate** — 100 V/ μ s (Inverting, $A_V = 1$) Typically
- **Fast Settling Time** — 800 ns Typically
- **Wide Bandwidth** — 65 MHz Typically
- **Wide Operating Supply Range**
- **Wide Input Voltage Ranges**

Absolute Maximum Ratings

Storage Temperature Range	-65°C to +175°C
Operating Temperature Range	
Extended ($\mu A715M$)	-55°C to +125°C
Commercial ($\mu A715C$)	0°C to +70°C
Lead Temperature	
Metal Can and Ceramic DIP (soldering, 60 s)	300°C
Internal Power Dissipation ^{1, 2}	
10L-Metal Can	1.07 W
14L-Ceramic DIP	1.36 W
Supply Voltage	± 18 V
Differential Input Voltage	± 15 V
Input Voltage ³	± 15 V

Notes

1. $T_{J \text{ Max}} = 175^\circ\text{C}$.
2. Ratings apply to ambient temperature at 25°C. Above this temperature, derate the 10L-Metal Can at 7.1 mW/ $^\circ\text{C}$, and the 14L-Ceramic DIP at 9.1 mW/ $^\circ\text{C}$.
3. For supply voltages less than ± 15 V, the absolute maximum input voltage is equal to the supply voltage.

Connection Diagram 10-Lead Metal Package (Top View)

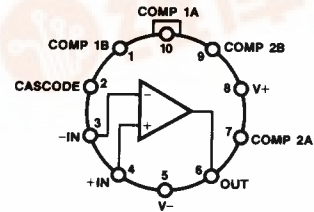

CD00700F

Lead 5 connected to case.

Order Information

Device Code	Package Code	Package Description
$\mu A715HM$	5X	Metal
$\mu A715HC$	5X	Metal

Connection Diagram 14-Lead DIP (Top View)

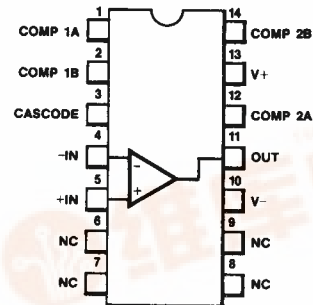

CD00711F

Order Information

Device Code	Package Code	Package Description
$\mu A715DM$	6A	Ceramic DIP
$\mu A715DC$	6A	Ceramic DIP



μ A715

Equivalent Circuit

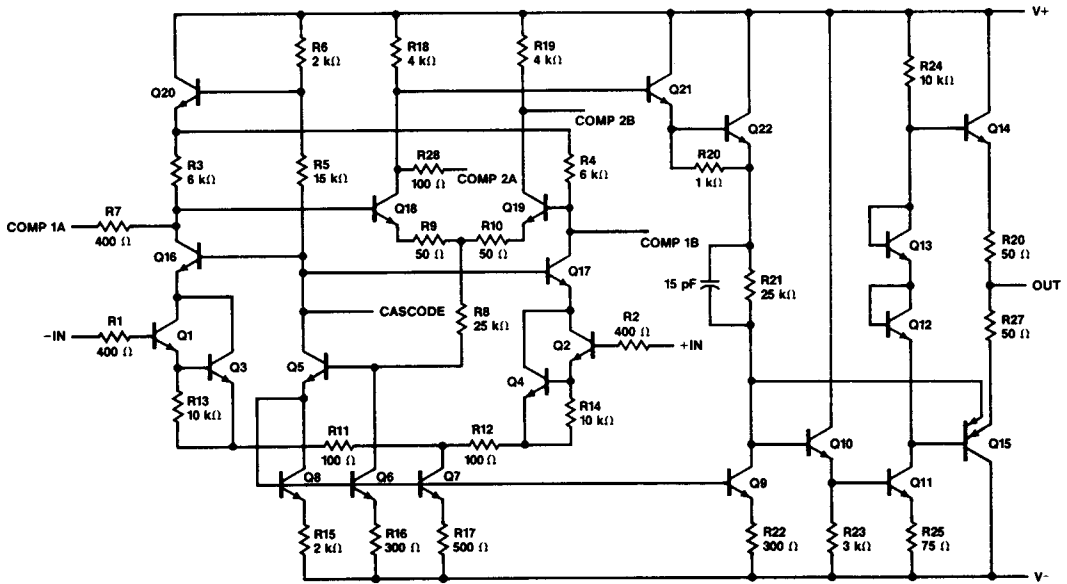

μA715

μA715 and μA715C

Electrical Characteristics $T_A = 25^\circ\text{C}$, $V_{CC} = \pm 15\text{ V}$, unless otherwise specified.

Symbol	Characteristic	Condition	μA715			μA715C			Unit
			Min	Typ	Max	Min	Typ	Max	
V_{IO}	Input Offset Voltage	$R_S \leq 10\text{ k}\Omega$		2.0	5.0		2.0	7.5	mV
I_{IO}	Input Offset Current			70	250		70	250	nA
I_{IB}	Input Bias Current			400	750		400	1500	nA
Z_I	Input Impedance			1.0			1.0		MΩ
R_O	Output Resistance			75			75		Ω
I_{CC}	Supply Current			5.5	7.0		5.5	10	mA
P_C	Power Consumption			165	210		165	300	mW
V_{IR}	Input Voltage Range		± 10	± 12		± 10	± 12		V
A_{VS}	Large Signal Voltage Gain	$R_L \geq 2.0\text{ k}\Omega$, $V_O = \pm 10\text{ V}$	15	30		10	30		V/mV
V	Settling Time	$V_O = \pm 5.0\text{ V}$, $A_V = 1.0$		800			800		ns
TR	Transient Response	Rise time		30	60		30	75	ns
		Overshoot		25	40		25	50	%
SR	Slew Rate	$A_V = 100$		70			70		V/μs
		$A_V = 10$		38			38		
		$A_V = 1.0$ (non-inverting)	15	18		10	18		
		$A_V = 1.0$ (inverting)		100			100		

The following specifications apply over the range of $-55^\circ\text{C} \leq T_A \leq +125^\circ\text{C}$ for the μA715, and $0^\circ\text{C} \leq T_A \leq +70^\circ\text{C}$ for the μA715C.

V_{IO}	Input Offset Voltage	$R_S \leq 10\text{ k}\Omega$			7.5			10	mV
I_{IO}	Input Offset Current	$T_A = T_A\text{ Max}$			250			250	nA
		$T_A = T_A\text{ Min}$			800			750	
I_{IB}	Input Bias Current	$T_A = T_A\text{ Max}$			750			1500	nA
		$T_A = T_A\text{ Min}$			4.0			7.5	
CMR	Common Mode Rejection	$R_S \leq 10\text{ k}\Omega$	74	92		74 ¹	92 ¹		db
PSRR	Power Supply Rejection Ratio	$R_S \leq 10\text{ k}\Omega$		45	300		45 ¹	400 ¹	μV/V
A_{VS}	Large Signal Voltage Gain	$R_L \geq 2.0\text{ k}\Omega$, $V_O = \pm 10\text{ V}$	10			8			V/mV
V_{OP}	Output Voltage Swing	$R_L = 2.0\text{ k}\Omega$	± 10	± 13		± 10	± 13		V

Note

1. $T_A = 25^\circ\text{C}$ only.

μA715

Typical Performance Curves for μA715 and μA715C

Voltage Gain vs Temperature (μA715)

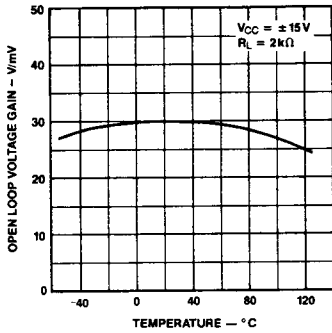

Supply Voltage Rejection Ratio vs Temperature (μA715)

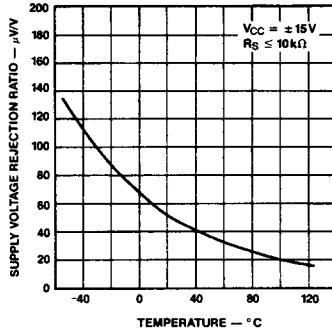

Slew Rate vs Temperature (μA715)

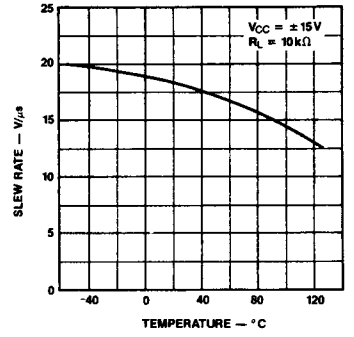

Common Mode Rejection Ratio vs Temperature (μA715)

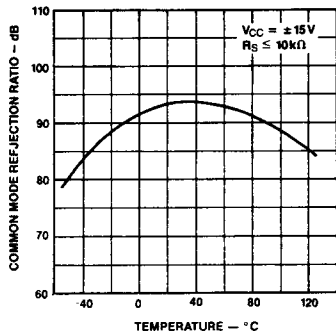

Voltage Gain vs Temperature (μA715C)

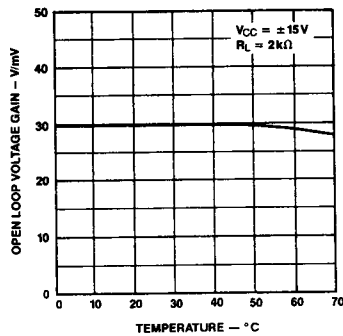

Supply Voltage Rejection Ratio vs Temperature (μA715C)

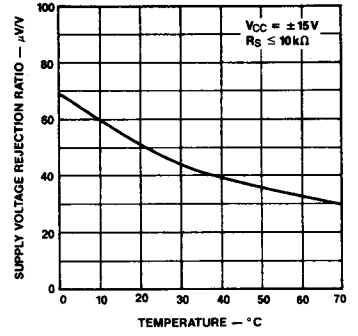

Slew Rate vs Temperature (μA715C)

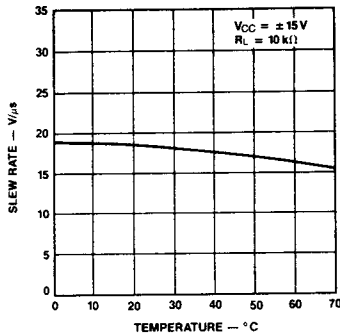

Common Mode Rejection Ratio vs Temperature (μA715C)

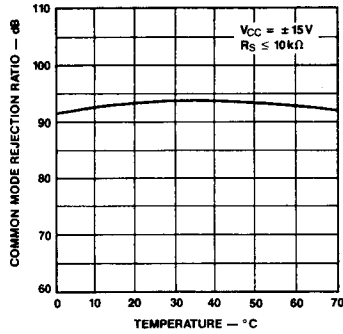

μA715

Typical Performance Curves for μA715 and μA715C

Frequency Response For Open Loop Gains (Note 1)

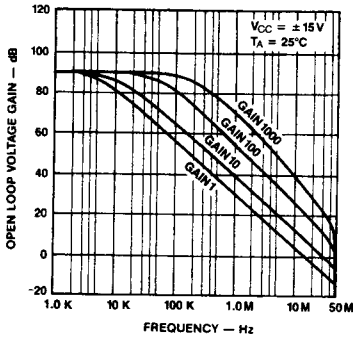

Frequency Response for Closed Loop Gains

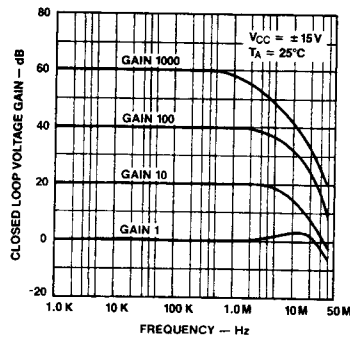

Voltage Gain vs Frequency

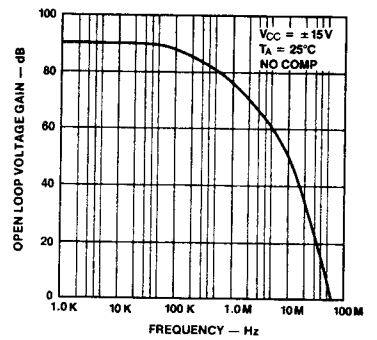

Supply Voltage Rejection Ratio vs Frequency

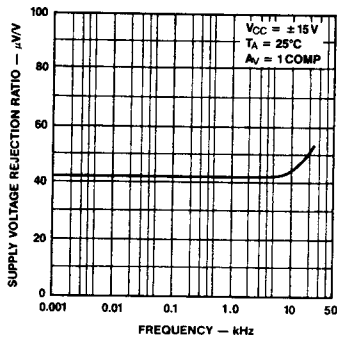

Output Swing vs Frequency for Closed Loop Gains

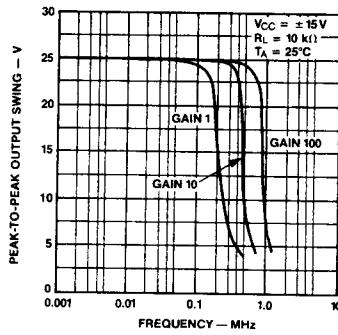

Open Loop Phase vs Frequency

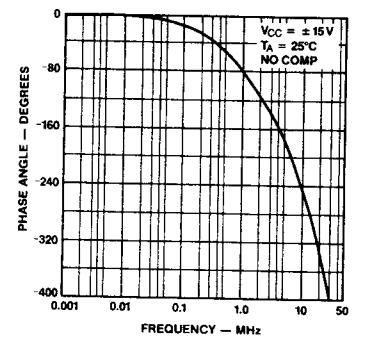

Common Mode Rejection Ratio vs Frequency

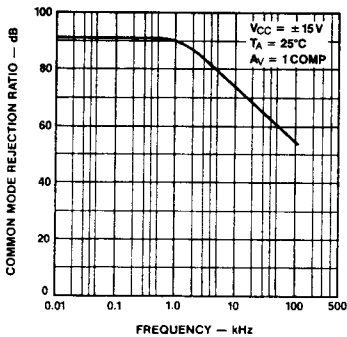

Unity Gain Large Signal Pulse Response

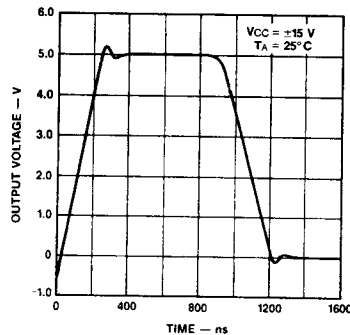

Large Signal Pulse Response for Gain 10

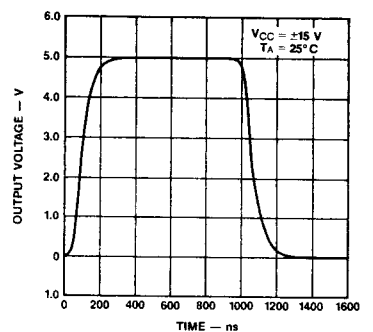

Note

1. See "Non-Inverting Compensation Components Value Table" for Closed Loop Gain values.

μA715

Typical Performance Curves for μA715 and μA715C (Cont.)

Large Signal Pulse Response for Gain 100

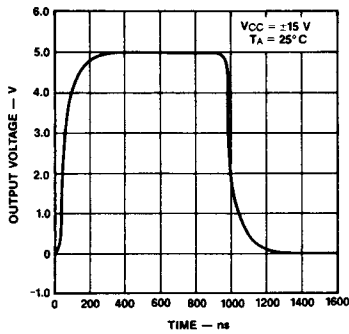

PC04770F

Slew Rate vs Closed Loop Voltage Gain

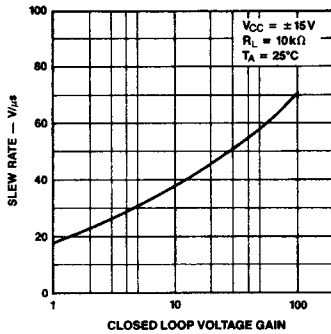

PC04781F

Slew Rate vs Supply Voltage

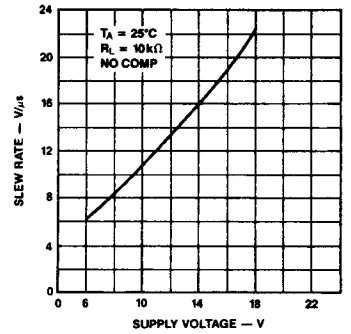

PC04790F

Voltage Follower Transient Response

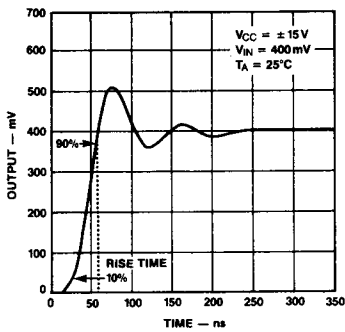

PC04800F

Inverting Unity Gain Large Signal Pulse Response

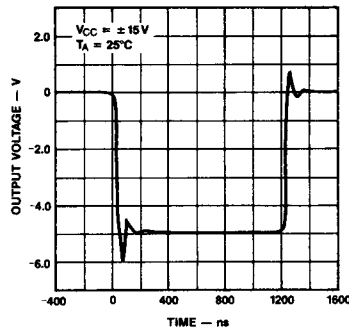

PC04810F

Small Signal Pulse Response Inverting Unity Gain

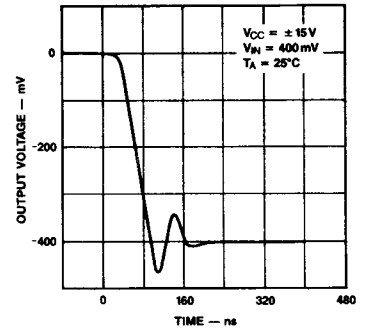

PC04830F

Voltage Follower (Note 1)

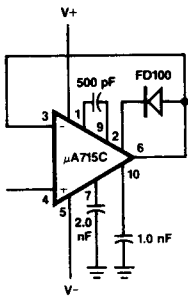

CR01310F

Voltage Offset Null Circuit (Note 1)

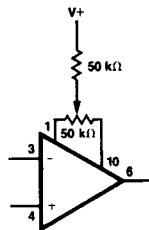

CR01321F

High Slew Rate Circuit (Note 1)

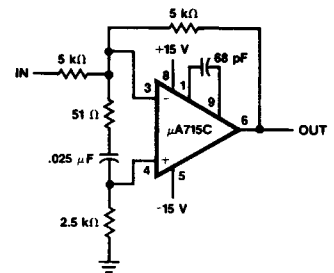

CR01491F

Note

1. Lead numbers apply to metal package.

μA715

Non-Inverting Compensation Components Values

Closed Loop Gain	C1	C2	C3
1000	10 pF		
100	50 pF		250 pF
10 (Note)	100 pF	500 pF	1000 pF
1	500 pF	2000 pF	1000 pF

Note

For gain 10, compensation may be simplified by removing C2, C3 and adding a 200 pF capacitor (C4) between Lead 7 and 10.

Suggested Values of Compensation Capacitors vs Closed Loop Voltage Gain

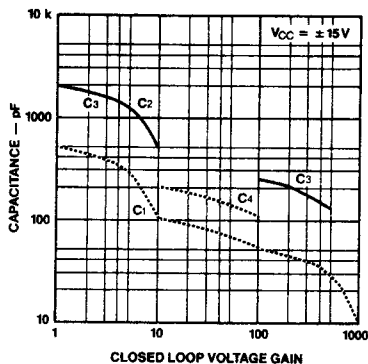

PCD4841F

Layout Instructions

Layout—The layout should be such that stray capacitance is minimal.

Supplies—The supplies should be adequately bypassed. Use of 0.1 μF high quality ceramic capacitors is recommended.

Ringing—Excessive ringing (long acquisition time) may occur with large capacitive loads. This may be reduced by isolating the capacitive load with a resistance of 100 Ω.

Frequency Compensation Circuit

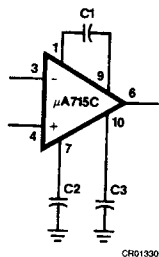

CR01330F

Note

Lead numbers apply to metal package.

Large source resistances may also give rise to the same problem and this may be decreased by the addition of a capacitance across the feedback resistance. A value of around 50 pF for unity gain configuration and around 3.0 pF for gain 10 should be adequate.

Latch Up—This may occur when the amplifier is used as a voltage follower. The inclusion of a diode between leads 6 and 2 with the cathode toward lead 2 is the recommended preventive measure.

μA715

Typical Applications

Wide Bank Video Amplifier Drive Capability With 75 Ω Coax Cable

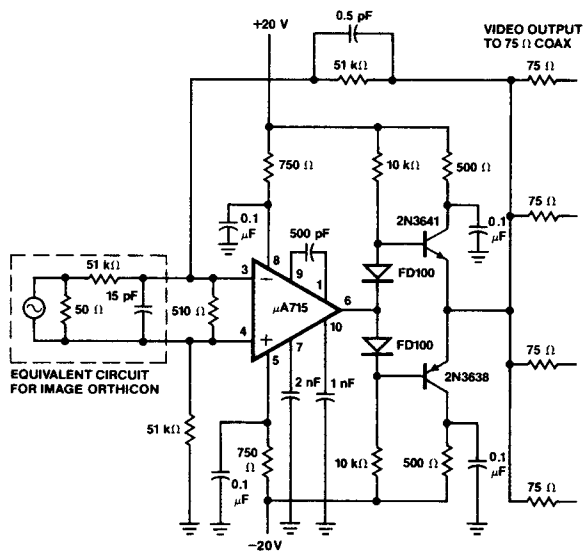
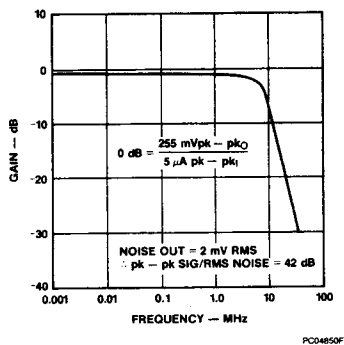

7

High Speed Integrator

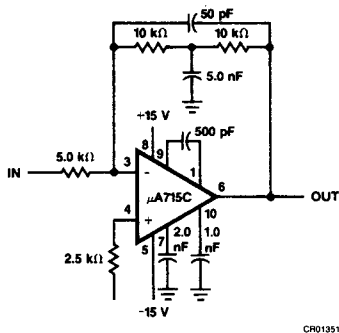
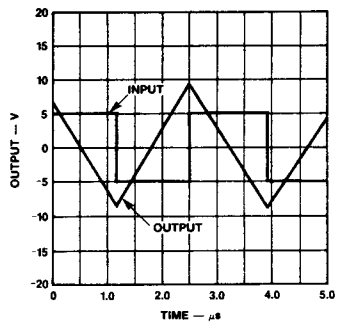

Note
All lead numbers shown refer to metal package.