

ZXMP2120E5

200V P-CHANNEL ENHANCEMENT MODE MOSFET

SUMMARY

$V_{(BR)DSS} = -200V$; $R_{DS(ON)} = 28\Omega$; $I_D = -122mA$

DESCRIPTION

This 200V enhancement mode P-channel MOSFET provides users with a competitive specification offering efficient power handling capability, high impedance and is free from thermal runaway and thermally induced secondary breakdown. Applications benefiting from this device include a variety of Telecom and general high voltage circuits.

A 4 pin SOT223 version is also available (ZXMP2120G4).

FEATURES

- High voltage
- Low on-resistance
- Fast switching speed
- Low gate drive
- Low threshold
- SOT23-5 package variant engineered to increase spacing between high voltage pins.

APPLICATIONS

- Active clamping of primary side MOSFETs in 48 volt DC-DC converters

ORDERING INFORMATION

DEVICE	REEL SIZE (inches)	TAPE WIDTH (mm)	QUANTITY PER REEL
ZXMP2120E5TA	7	8mm embossed	3,000 units

DEVICE MARKING

- P120

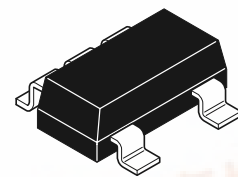

SOT23-5

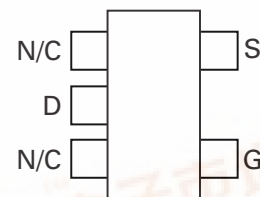
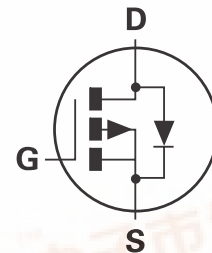

PINOUT - TOP VIEW

ZXMP2120E5

ABSOLUTE MAXIMUM RATINGS

PARAMETER	SYMBOL	LIMIT	UNIT
Drain-Source Voltage	V_{DSS}	-200	V
Gate Source Voltage	V_{GS}	± 20	V
Continuous Drain Current ($V_{GS}=10V$; $T_{amb}=25^{\circ}C$) ^(a)	I_D	-122	mA
Pulsed Drain Current (c)	I_{DM}	-0.7	A
Pulsed Source Current (Body Diode) (c)	I_{SM}	-0.7	A
Power Dissipation at $T_{amb}=25^{\circ}C$ (a)	P_D	0.75	W
Linear Derating Factor		6	mW/ $^{\circ}C$
Operating and Storage Temperature Range	T_j ; T_{stg}	-55 to +150	$^{\circ}C$

THERMAL RESISTANCE

PARAMETER	SYMBOL	VALUE	UNIT
Junction to Ambient (a)	$R_{\theta JA}$	167	$^{\circ}C/W$

NOTES

- (a) For a device surface mounted on 25mm x 25mm FR4 PCB with high coverage of single sided 1oz copper, in still air conditions
(b) For a device surface mounted on FR4 PCB measured at $t \leq 5$ secs.
(c) Repetitive rating - pulse width limited by maximum junction temperature. Refer to Transient Thermal Impedance graph.

ZXMP2120E5

ELECTRICAL CHARACTERISTICS (at $T_{amb} = 25^{\circ}\text{C}$ unless otherwise stated)

PARAMETER	SYMBOL	MIN.	TYP.	MAX.	UNIT	CONDITIONS.
STATIC						
Drain-Source Breakdown Voltage	$V_{(BR)DSS}$	-200			V	$I_D = -1\text{mA}$, $V_{GS} = 0\text{V}$
Gate-Source Threshold Voltage	$V_{GS(th)}$	-1.5		-3.5	V	$I_D = -1\text{mA}$, $V_{DS} = V_{GS}$
Gate-Body Leakage	I_{GSS}			20	nA	$V_{GS} = \pm 20\text{V}$, $V_{DS} = 0\text{V}$
Zero Gate Voltage Drain Current	I_{DSS}			-10 -100	μA μA	$V_{DS} = -200\text{V}$, $V_{GS} = 0$ $V_{DS} = -160\text{V}$, $V_{GS} = 0\text{V}$, $T = 125^{\circ}\text{C}$ (2)
On-State Drain Current ⁽¹⁾	$I_{D(on)}$	-300			mA	$V_{DS} = -25\text{V}$, $V_{GS} = -10\text{V}$
Static Drain-Source On-State Resistance ⁽¹⁾	$R_{DS(on)}$			28	Ω	$V_{GS} = -10\text{V}$, $I_D = -150\text{mA}$
Forward Transconductance ⁽¹⁾⁽²⁾	g_{fs}	50			mS	$V_{DS} = -25\text{V}$, $I_D = -150\text{mA}$
DYNAMIC						
Input Capacitance ⁽²⁾	C_{iss}			100	pF	$V_{DS} = -25\text{V}$, $V_{GS} = 0\text{V}$, $f = 1\text{MHz}$
Output Capacitance ⁽²⁾	C_{oss}			25	pF	
Reverse Transfer Capacitance ⁽²⁾	C_{rss}			7	pF	
SWITCHING						
Turn-On Delay Time ⁽²⁾⁽³⁾	$t_{d(on)}$			7	ns	$V_{DD} = -25\text{V}$, $I_D = -150\text{mA}$
Rise Time ⁽²⁾⁽³⁾	t_r			15	ns	
Turn-Off Delay Time ⁽²⁾⁽³⁾	$t_{d(off)}$			12	ns	
Fall Time ⁽²⁾⁽³⁾	t_f			15	ns	

NOTES:

(1) Measured under pulsed conditions. Width=300 μs . Duty cycle $\leq 2\%$.

(2) Sample test.

(3) Switching times measured with 50 Ω source impedance and <5ns rise time on a pulse generator.

ZXMP2120E5

TYPICAL CHARACTERISTICS

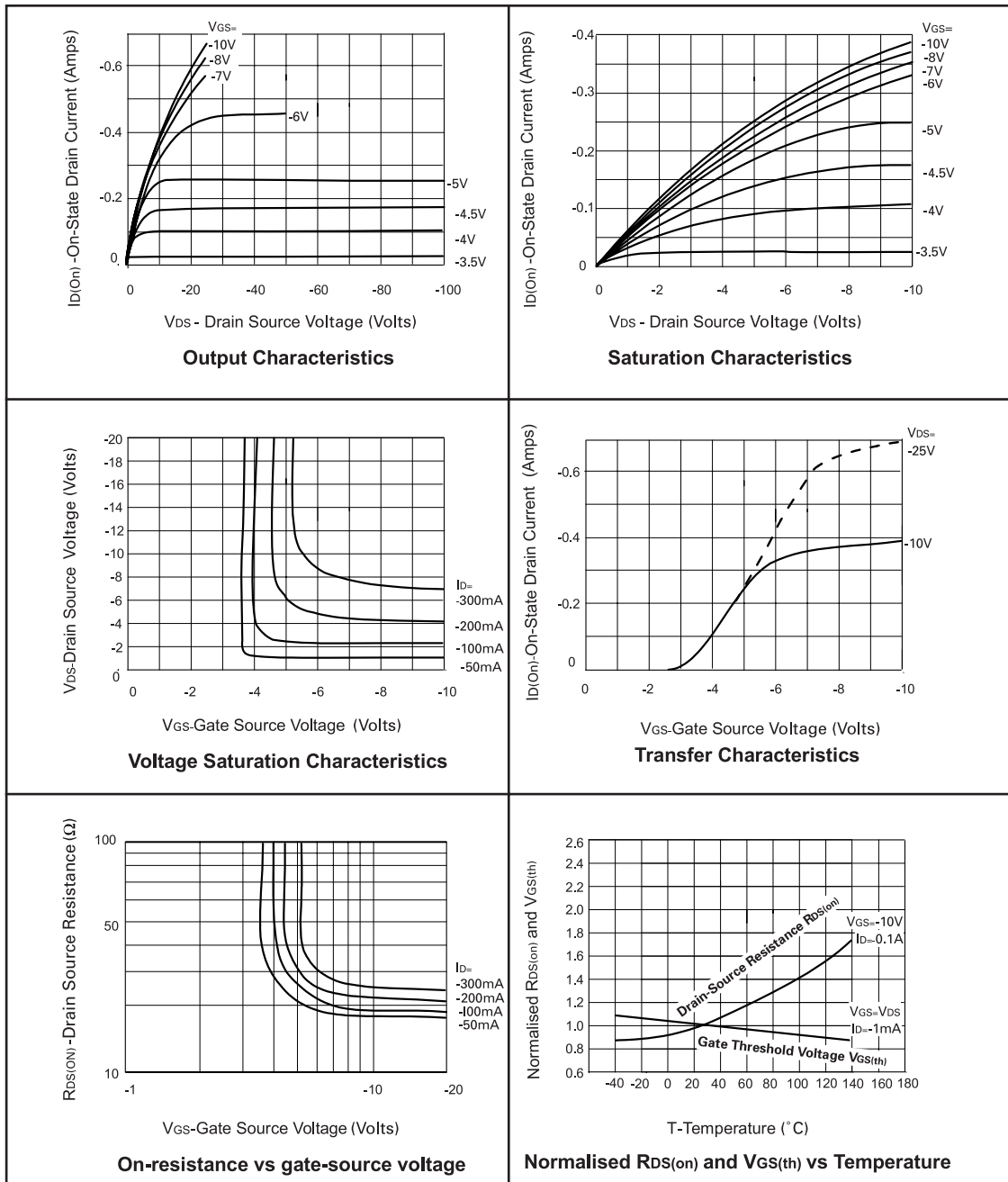

ZXMP2120E5

CHARACTERISTICS

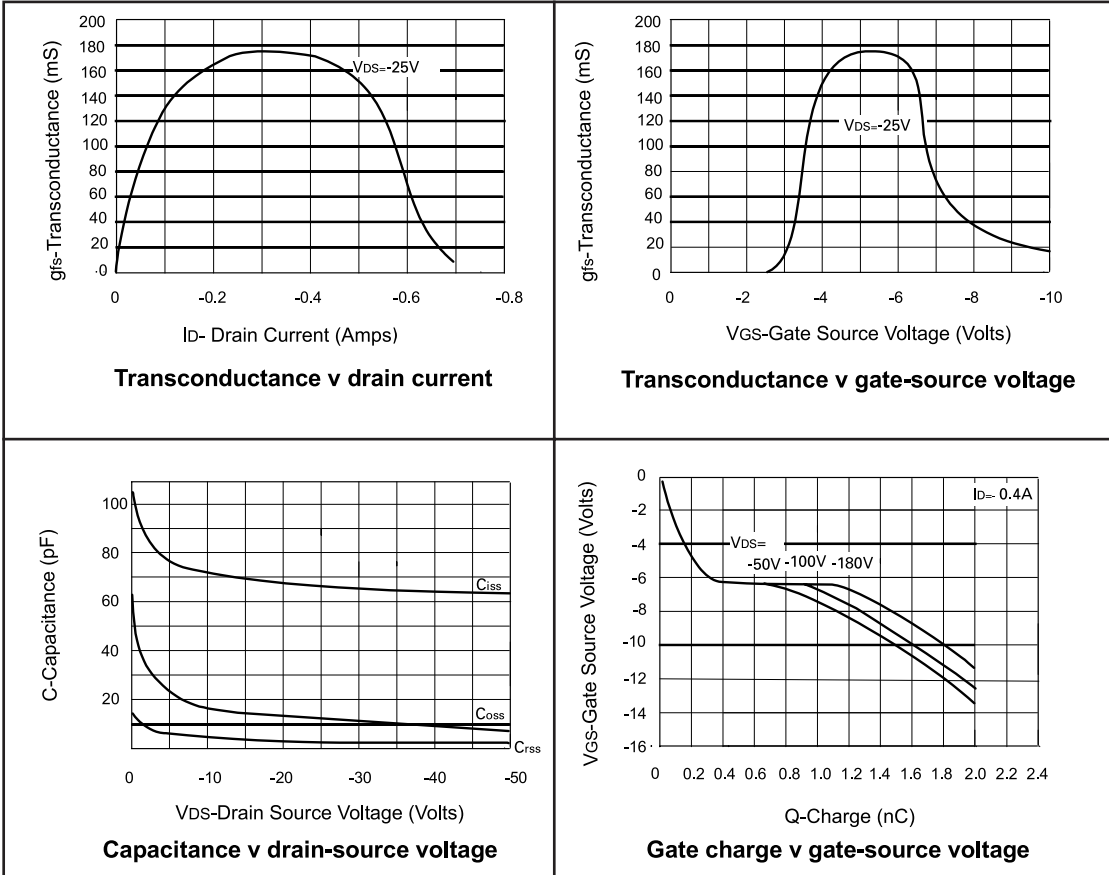

ZXMP2120E5

PACKAGE OUTLINE

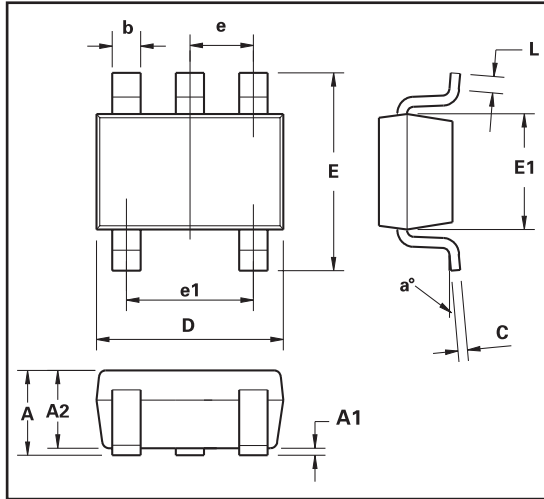

PAD LAYOUT DETAILS

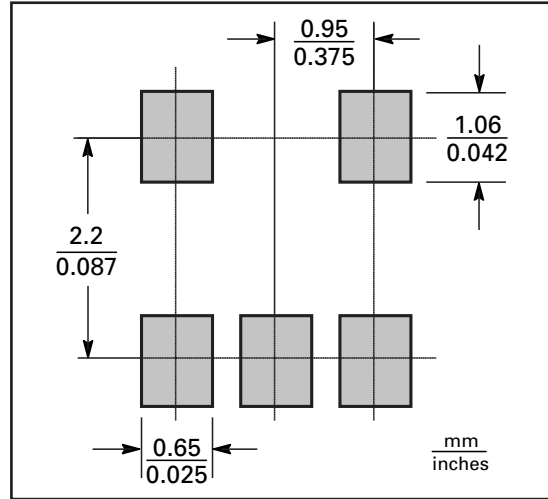

Controlling dimensions are in millimeters. Approximate conversions are given in inches

PACKAGE DIMENSIONS

DIM	Millimeters		Inches	
	MIN.	MAX.	MIN.	MAX.
A	0.90	1.45	0.0354	0.0570
A1	-	0.15	-	0.0059
A2	0.90	1.30	0.0354	0.0511
b	0.20	0.50	0.0078	0.0196
C	0.09	0.26	0.0035	0.0102
D	2.70	3.10	0.1062	0.1220

DIM	Millimeters		Inches	
	MIN.	MAX.	MIN.	MAX.
E	2.20	3.20	0.0866	0.1181
E1	1.30	1.80	0.0511	0.0708
e	0.95 REF		0.0374 REF	
e1	1.90 REF		0.0748 REF	
L	0.10	0.60	0.0039	0.0236
a	0°	30°	0°	30°

© Zetex Semiconductors plc 2006

Europe	Americas	Asia Pacific	Corporate Headquarters
Zetex GmbH Kustermann-park Balanstraße 59 D-81541 München Germany Telephone: (49) 89 45 49 49 0 Fax: (49) 89 45 49 49 49 europe.sales@zetex.com	Zetex Inc 700 Veterans Memorial Hwy Hauppauge, NY 11788 USA Telephone: (1) 631 360 2222 Fax: (1) 631 360 8222 usa.sales@zetex.com	Zetex (Asia) Ltd 3701-04 Metroplaza Tower 1 Hing Fong Road, Kwai Fong Hong Kong Telephone: (852) 26100 611 Fax: (852) 24250 494 asia.sales@zetex.com	Zetex Semiconductors plc Zetex Technology Park Chadderton, Oldham, OL9 9LL United Kingdom Telephone (44) 161 622 4444 Fax: (44) 161 622 4446 hq@zetex.com

These offices are supported by agents and distributors in major countries world-wide.

This publication is issued to provide outline information only which (unless agreed by the Company in writing) may not be used, applied or reproduced for any purpose or form part of any order or contract or be regarded as a representation relating to the products or services concerned. The Company reserves the right to alter without notice the specification, design, price or conditions of supply of any product or service.

For the latest product information, log on to www.zetex.com



ISSUE 2 - SEPTEMBER 2006