

Analog Devices Welcomes Hittite Microwave Corporation

NO CONTENT ON THE ATTACHED DOCUMENT HAS CHANGED



HMC728* Product Page Quick Links

Last Content Update: 11/01/2016

[Comparable Parts](#)

View a parametric search of comparable parts

[Evaluation Kits](#)

- [HMC728LC3C Evaluation Board](#)

[Documentation](#)

Data Sheet

- [HMC728 Data Sheet](#)

[Reference Materials](#)

Quality Documentation

- [Package/Assembly Qualification Test Report: LC3, LC3B, LC3C \(QTR: 2014-00376 REV: 01\)](#)
- [Semiconductor Qualification Test Report: BiCMOS-C \(QTR: 2013-00241\)](#)

[Design Resources](#)

- [HMC728 Material Declaration](#)
- [PCN-PDN Information](#)
- [Quality And Reliability](#)
- [Symbols and Footprints](#)

[Discussions](#)

View all HMC728 EngineerZone Discussions

[Sample and Buy](#)

Visit the product page to see pricing options

[Technical Support](#)

Submit a technical question or find your regional support number

THIS PAGE INTENTIONALLY LEFT BLANK

Typical Applications

The HMC728LC3C is ideal for:

- 2:1 Multiplexer up to 14 Gbps
- RF ATE Applications
- Broadband Test & Measurement
- Serial Data Transmission up to 14 Gbps
- Redundant Path Switching
- Built-in Test

Features

- Supports High Data Rates: up to 14 Gbps
- Single-Ended Inputs
- Differential or Single-Ended Outputs
- Fast Rise and Fall Times: 17 / 15 ps
- Low Power Consumption: 250 mW typ.
- Propagation Delay: 125 ps
- Single Supply: -3.3 V
- 16 Lead Ceramic 3x3 mm SMT Package: 9 mm²

Functional Diagram

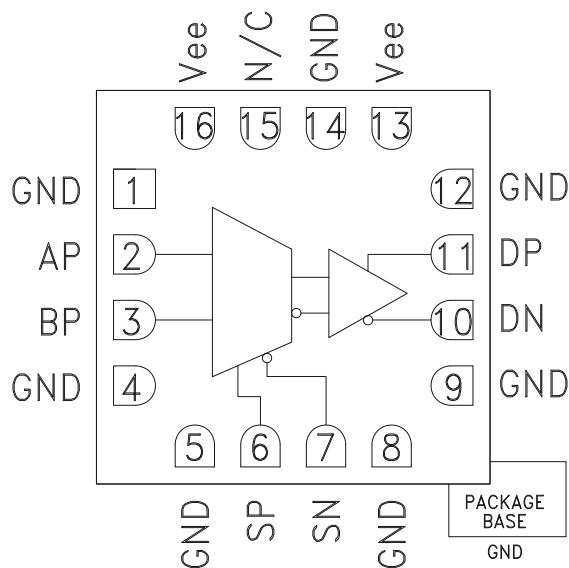

General Description

The HMC728LC3C is a 2:1 Selector designed to support data transmission rates of up to 14 Gbps, and selector port operation of up to 14 GHz. The selector routes one of the two single-ended inputs to the differential output upon assertion of the proper select port.

All differential inputs to the HMC728LC3C are CML and terminated on-chip with 50 Ohms to the positive supply, GND, and may be DC or AC coupled. The differential CML outputs are source terminated to 50 Ohms and may also be AC or DC coupled. Outputs can be connected directly to a 50 Ohm ground-terminated system or drive devices with CML logic input. The HMC728LC3C operates from a single -3.3 V supply and is available in ROHS-compliant 3x3 mm SMT package.

Electrical Specifications, $T_A = +25\text{ }^\circ\text{C}$, $V_{ee} = -3.3\text{ V}$

Parameter	Conditions	Min.	Typ.	Max	Units
Power Supply Voltage		-3.6	-3.3	-3.0	V
Power Supply Current			76		mA
Maximum Data Rate			14		Gbps
Maximum Select Rate			14		GHz
Maximum Serial Transmission Rate			26		Gbps
Input Vcm	$V_{in} = 600\text{ mVp-p}$, Single-Ended	-0.375	-0.300	-0.275	V
Input Voltage Range		-1.5		0.5	V
Input Differential Range		0.1		2.0	Vp-p
Input Return Loss	Frequency <14 GHz		10		dB
Output Amplitude	Single-Ended, peak-to-peak		550		mVp-p
	Differential, peak-to-peak		1100		mVp-p
Output High Voltage			-10		mV



Electrical Specifications (continued)

Parameter	Conditions	Min.	Typ.	Max	Units
Output Low Voltage			-560		mV
Output Rise / Fall Time	Differential, 20% - 80%		17 / 15		ps
Output Return Loss	Frequency <14 GHz		10		dB
Random Jitter, Jr	rms			0.2	ps rms
Deterministic Jitter, Jd	peak-to-peak, 2 ¹⁵ -1 PRBS input [1]		2		ps, p-p
Propagation Delay, A or B to D _{OUT} , td			125		ps
Propagation Delay Select to Data, tds			135		ps
Set Up & Hold Time, t _{SH}			6		ps

[1] Deterministic jitter calculated by simultaneously measuring the jitter of a 300 mV, 13 GHz, 2¹⁵-1 PRBS input, and a single-ended output

DC Current vs. Supply Voltage [1]

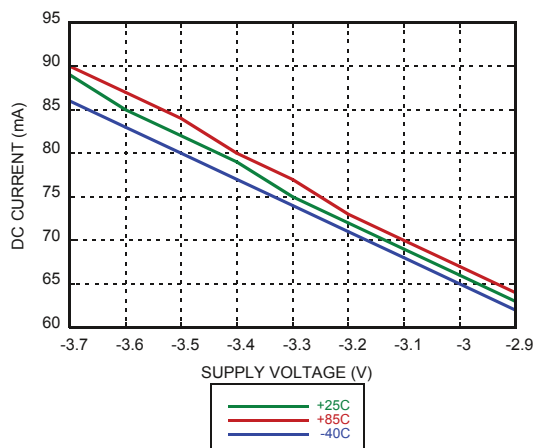

Output Differential Voltage vs. Supply Voltage [2]

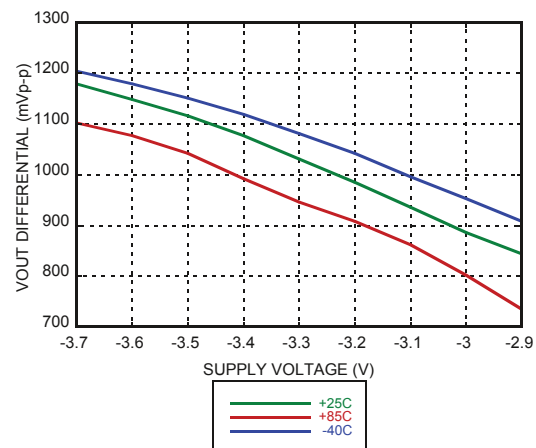

Rise / Fall Time vs. Supply Voltage [1]

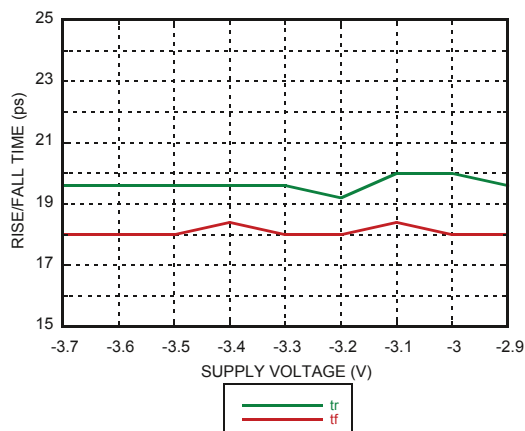

Output Differential Voltage vs. Frequency [3]

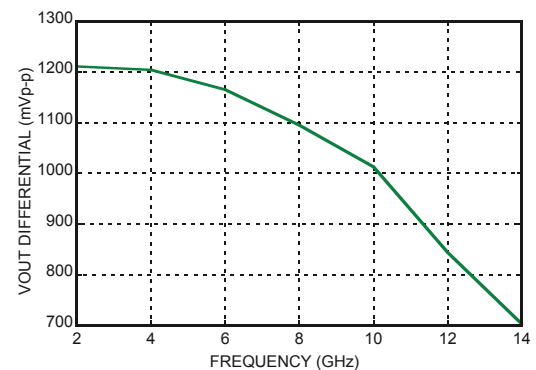

[1] Data rate = 13 Gbps

[2] Frequency = 10 GHz

[3] Vee = -3/3 V



Output Return Loss vs. Frequency

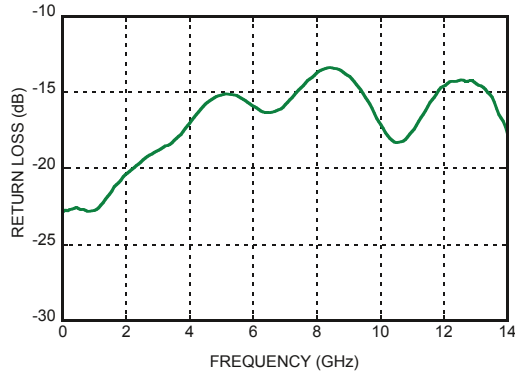

Return Loss of Select Input

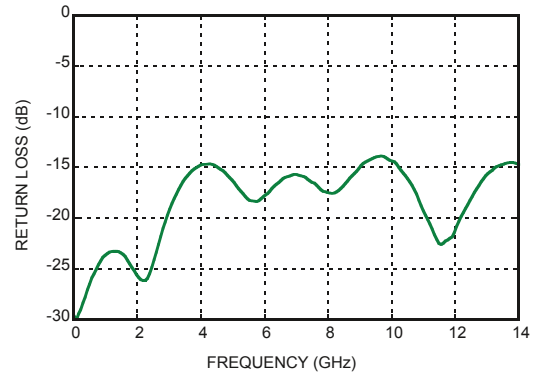

Return Loss of Data Input

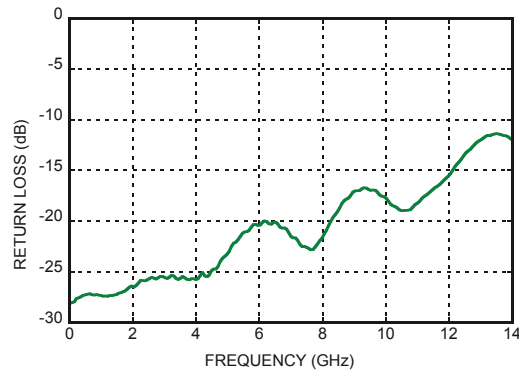



Eye Diagram

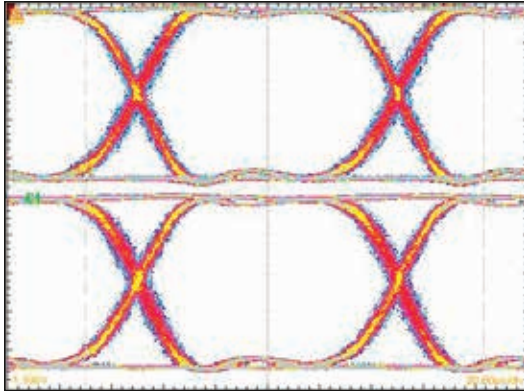

[1] Test Conditions:
 Waveform generated with an Agilent N4903A J-Bert.
 Rate = 10 Gbps
 Eye Diagram data presented on a Tektronix CSA 8000

Timing Diagram

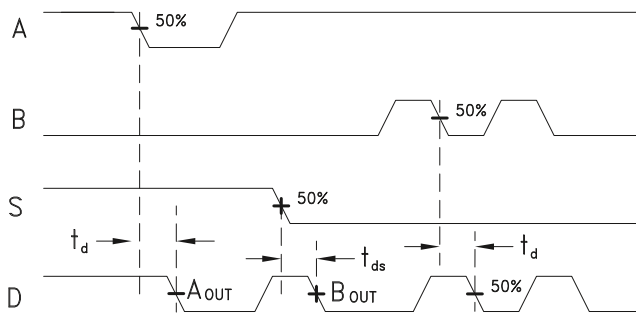

t_d = propagation delay, A or B to Dout
 t_{ds} = propagation delay, Select to Dout

Truth Table

Inputs	Outputs
S	DP
H	A -> D
L	B -> D
H - Positive voltage level L - Negative voltage level	
Notes: D = DP - DN S = SP - SN	



Absolute Maximum Ratings

Power Supply Voltage (Vee)	-3.75 V to +0.5 V
Input Signals	-2 V to +0.5 V
Output Signals	-1.5 V to +1 V
Continuous Pdiss (T = 85 °C) (derate 17 mW/°C above 85 °C)	0.68 W
Thermal Resistance (R _{th j-p}) Worst case junction to package paddle	59 °C/W
Maximum Junction Temperature	125 °C
Storage Temperature	-65 °C to +150 °C
Operating Temperature	-40 °C to +85 °C
ESD Sensitivity (HBM)	Class 1C



**ELECTROSTATIC SENSITIVE DEVICE
OBSERVE HANDLING PRECAUTIONS**

Outline Drawing

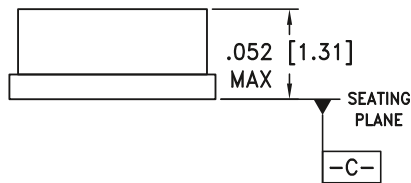
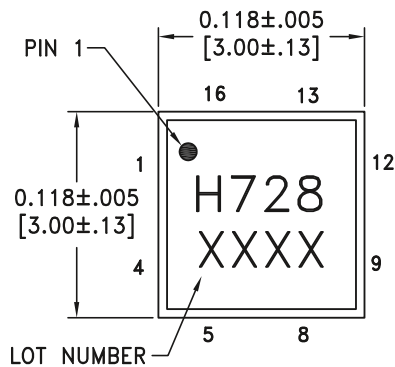

BOTTOM VIEW

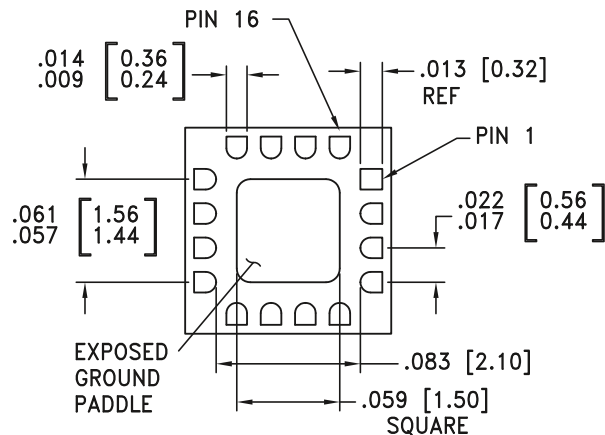

NOTES:

1. PACKAGE BODY MATERIAL: ALUMINA
2. LEAD AND GROUND PADDLE PLATING:
30-80 MICROINCHES GOLD OVER 50 MICROINCHES MINIMUM NICKEL.
3. DIMENSIONS ARE IN INCHES [MILLIMETERS].
4. LEAD SPACING TOLERANCE IS NON-CUMULATIVE.
5. PACKAGE WARP SHALL NOT EXCEED 0.05 mm DATUM -C-
6. ALL GROUND LEADS MUST BE SOLDERED TO PCB RF GROUND.
7. PADDLE MUST BE SOLDERED TO GND.

Package Information

Part Number	Package Body Material	Lead Finish	MSL Rating	Package Marking ^[2]
HMC728LC3C	Alumina, White	Gold over Nickel	MSL3 ^[1]	H728 XXXX

[1] Max peak reflow temperature of 260 °C

[2] 4-Digit lot number XXXX



Pin Descriptions

Pin Number	Function	Description	Interface Schematic
1, 4, 5, 8, 9, 12	GND	Signal Grounds.	
2, 3	AP, BP	Single-Ended Data Inputs: Current Mode Logic (CML) referenced to positive supply.	
6, 7	SP, SN	Differential Select Inputs: Current Mode Logic (CML) referenced to positive supply	
10, 11	DP, DN	Differential Data Outputs: Common Mode Logic (CML) referenced to positive supply.	
13, 16	Vee	Negative Supply	
14, Package Base	GND	Supply Ground	
15	N/C	No Connection	

Evaluation PCB

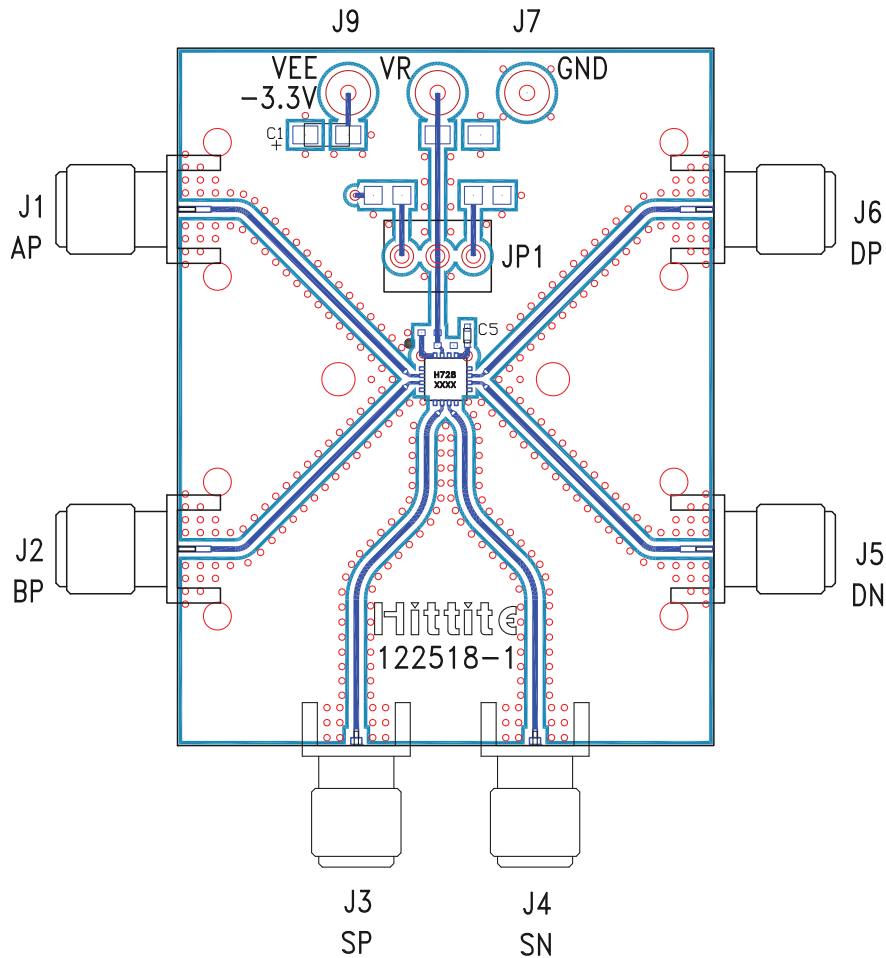

List of Materials for Evaluation PCB 122520 [1]

Item	Description
J1 - J6	PCB Mount SMA RF Connectors
J7, J9	DC Pin
C1	4.7 μ F Capacitor, Tantalum
C5	100 pF Capacitor, 0402 Pkg.
U1	HMC728LC3C High Speed Logic, 2:1 Selector
PCB [2]	122518 Evaluation Board

[1] Reference this number when ordering complete evaluation PCB

[2] Circuit Board Material: Arlon 25FR or Rogers 4350

The circuit board used in the application should use RF circuit design techniques. Signal lines should have 50 Ohm impedance while the package ground leads should be connected directly to the ground plane similar to that shown. The exposed package base should be connected to GND. A sufficient number of via holes should be used to connect the top and bottom ground planes. The evaluation circuit board shown is available from Hittite upon request.

Application Circuit

