

MAXIM

±15V Chopper-Stabilized Operational Amplifier

MAX430/432

General Description

The MAX430 and MAX432 are CMOS ±15V chopper-stabilized amplifiers designed for high accuracy signal conditioning, amplification, and instrumentation applications. They offer input offset and drift specifications superior to previous "precision" bipolar op amps and monolithic chopper amplifiers. External capacitors, required with previous CMOS chopper amplifiers, are NOT needed with the MAX430/MAX432. Both amplifiers are packaged in 8-pin plastic DIPs.

The combination of ±15V operation, low-power, and standard op-amp pin configuration allows these devices to plug directly into almost any OP07/OP77/LM108/μA741 socket regardless of what offset balancing or frequency compensation circuitry might be present. A wide input voltage range that includes the negative supply allows applications not possible with most conventional operational amplifiers.

The MAX430 has a maximum supply current of 2mA and a unity-gain frequency of 500kHz; the MAX432 has a maximum supply current of 0.5mA and a unity-gain frequency of 125kHz.

Applications

- Precision Amplifiers
- Signal Conditioning for:
 - Thermocouples
 - Strain Gauges, Load Cells
 - Resistance Temperature Devices (RTDs)
- High Accuracy Data Acquisition
- DC Stabilization of Amplifiers and Systems
- 4mA-20mA Process Control Transmitters

Pin Configuration

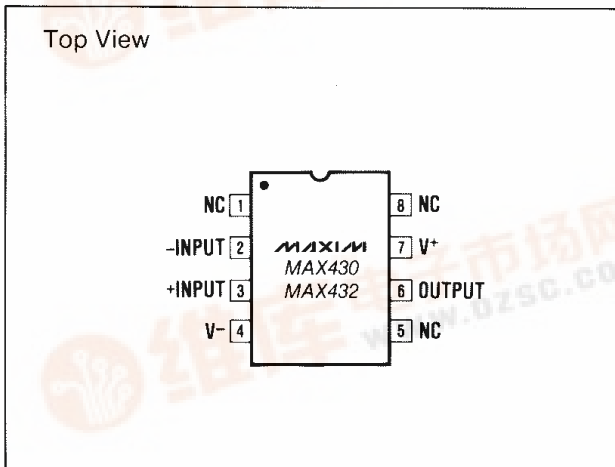

Features

- ◆ No External Capacitors Required
- ◆ 10μV Max Offset Voltage
- ◆ 30pA Input Bias Current
- ◆ Low Input Voltage Noise 0.3μVp-p (DC-1Hz)
- ◆ Low Input Current Noise 0.01pA/√Hz at 10Hz
- ◆ ±15V Supply Operation
- ◆ Input Voltage Range Includes V⁻
- ◆ Low Power CMOS Design

Ordering Information

PART	TEMP. RANGE	PACKAGE
MAX430CPA	0°C to +70°C	8 Lead Plastic DIP
MAX430EPA	-40°C to +85°C	8 Lead Plastic DIP
MAX432CPA	0°C to +70°C	8 Lead Plastic DIP
MAX432EPA	-40°C to +85°C	8 Lead Plastic DIP

Typical Operating Circuit

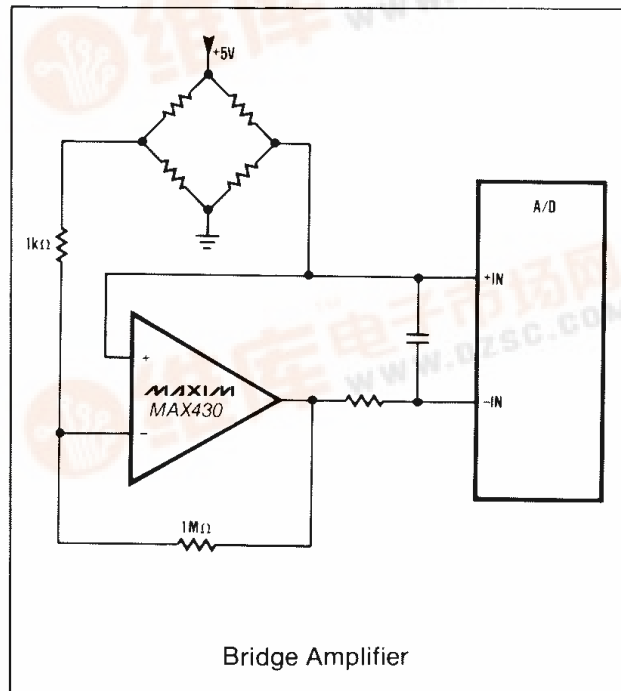

Bridge Amplifier

±15V Chopper-Stabilized Operational Amplifier

ABSOLUTE MAXIMUM RATINGS

Total Supply Voltage (V^+ to V^-)	+36V
Input Voltage	(V^+ +0.3V) to (V^- -0.3V)
Storage Temperature Range	-65°C to +160°C
Operating Temperature Range	
MAX430C, MAX432C	0°C to +70°C
MAX430E, MAX432E	-40°C to +85°C

Lead Temperature (Soldering 10 sec)	+300°C
Duration of Output Short Circuit	Indefinite
Current into Any Pin	10mA
Continuous Total Power Dissipation	375mW

Stresses above those listed under "Absolute Maximum Ratings" may cause permanent damage to the device. These are stress ratings only, and functional operation of the device at these or any other conditions above those indicated in the operational sections of the specifications is not implied. Exposure to absolute maximum ratings conditions for extended periods may affect device reliability.

ELECTRICAL CHARACTERISTICS

($V^+ = +15V$, $V^- = -15V$, $T_A = +25^\circ C$, Test circuit unless otherwise noted)

PARAMETER	SYMBOL	CONDITIONS	MAX430			MAX432			UNITS
			MIN	TYP	MAX	MIN	TYP	MAX	
Input Offset Voltage	$+V_{OS}$	$T_A = +25^\circ C$		2	10		2	10	μV
Average Temperature Coefficient of Input Offset Voltage		Over Temperature Range (Note 1)		0.02	0.05		0.02	0.05	$\mu V/^\circ C$
Input Bias Current (Doubles every 10°C above about 60°C)	I_B	$T_A = +25^\circ C$ Over Temp.		10 35	100		10 35	100	pA
Input Offset Current (Doubles every 10°C above about 60°C)	I_B	$T_A = +25^\circ C$ Over Temp.		15 50	200		15 50	200	pA
Input Resistance	R_{IN}			10^{12}			10^{12}		Ω
Large Signal Voltage Gain	A_{VOL}	$R_L = 10k\Omega$, $V_{OUT} = \pm 10V$	120	150		120	150		dB
Output Voltage Swing	V_{OUT}	$R_L = 10k\Omega$ $R_L = 100k\Omega$	± 12	± 14.5 ± 14.95		± 14	± 14.6		V
Common Mode Voltage Range	CMVR	Positive Negative	+11 -15	+11.5 -15.1		+11 -15	+11.5 -15.1		V
Common Mode Rejection Ratio	CMRR	CMVR = +11V to -15V $T_A = +25^\circ C$ Over Temp.	120 110	140 140		120 110	140 140		dB
Power Supply Rejection Ratio	PSSR	$\pm 4V$ to $\pm 16.5V$, $T_A = +25^\circ C$ Over Temp.	120 110	140 140		120 110	140 140		dB
Input Noise Voltage (P-P value not exceeded 95% of time)	e_{Np-p}	$R_S = 100\Omega$, DC to 1Hz DC to 10Hz		0.3 1.1			0.4 1.2		μV_{p-p}
Input Noise Current	i_N	$f = 10Hz$		0.01			0.01		pA/ \sqrt{Hz}
Unity-Gain Bandwidth	GBW			500			125		kHz
Slew Rate	SR	$C_L = 50pF$, $R_L = 100k\Omega$		0.5			0.125		V/ μs
Rise Time	t_R			0.7			2.8		μs
Overshoot				20			20		%
Operating Supply Range	V^+ , V^-		± 2.5		± 16.5	± 2.5		± 16.5	V
Supply Current	I_S	No Load, $T_A = +25^\circ C$ Over Temp.		1.3 2.0 3.5			0.3 0.5 1		mA
Internal Chopping Frequency	f_{CH}			400			250		Hz
Offset Voltage vs. Time				100			100		nV/ $\sqrt{mo.}$

Note 1: Guaranteed by design.

Note 2: All pins are designed to withstand electrostatic discharge (ESD) levels in excess of 2000V (Mil-Std-883C Method 3015.2 Test Circuit).

±15V Chopper-Stabilized Operational Amplifier

Typical Operating Characteristics

MAX430/432

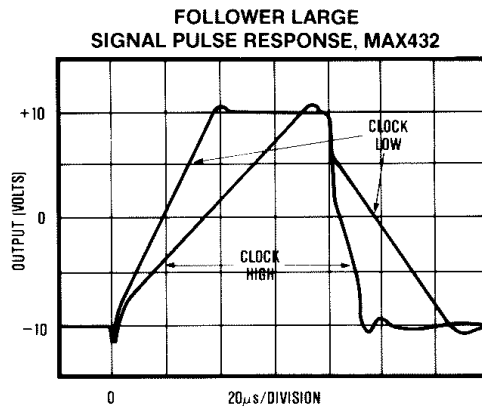
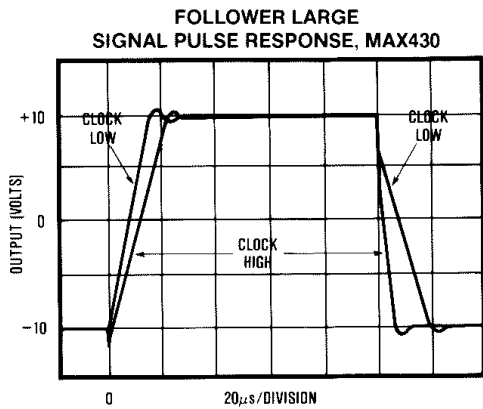
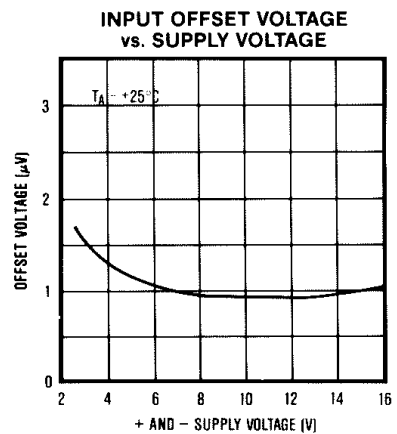
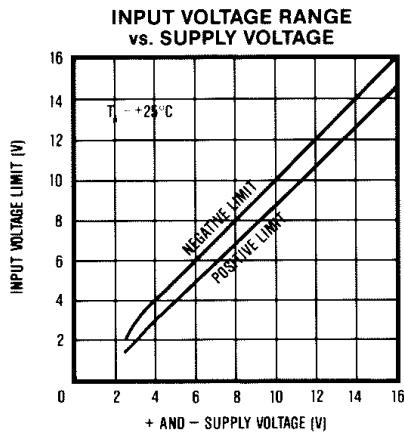
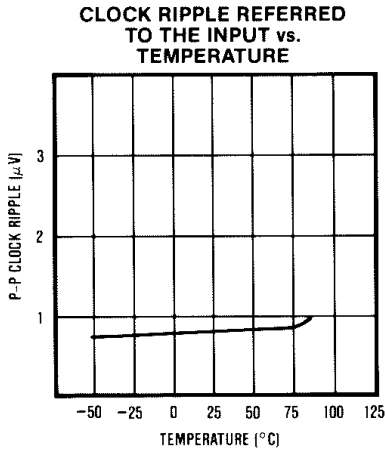
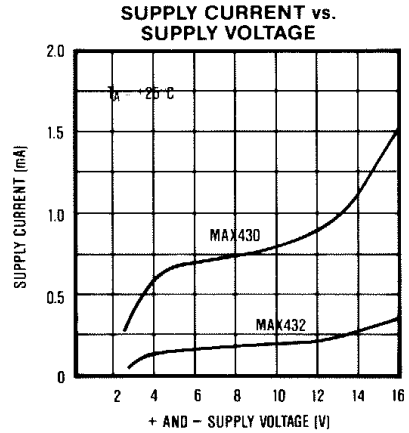
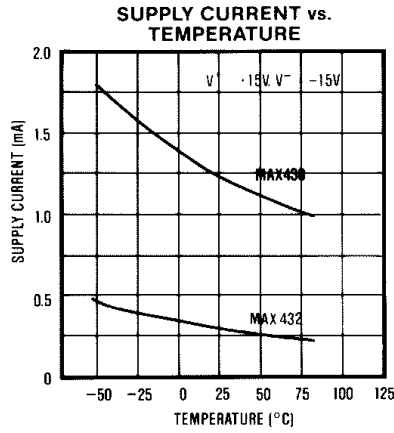
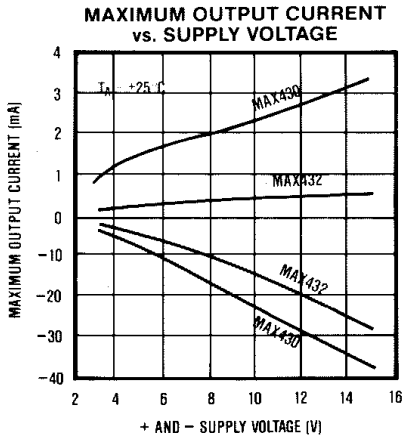

±15V Chopper-Stabilized Operational Amplifier

Typical Operating Characteristics

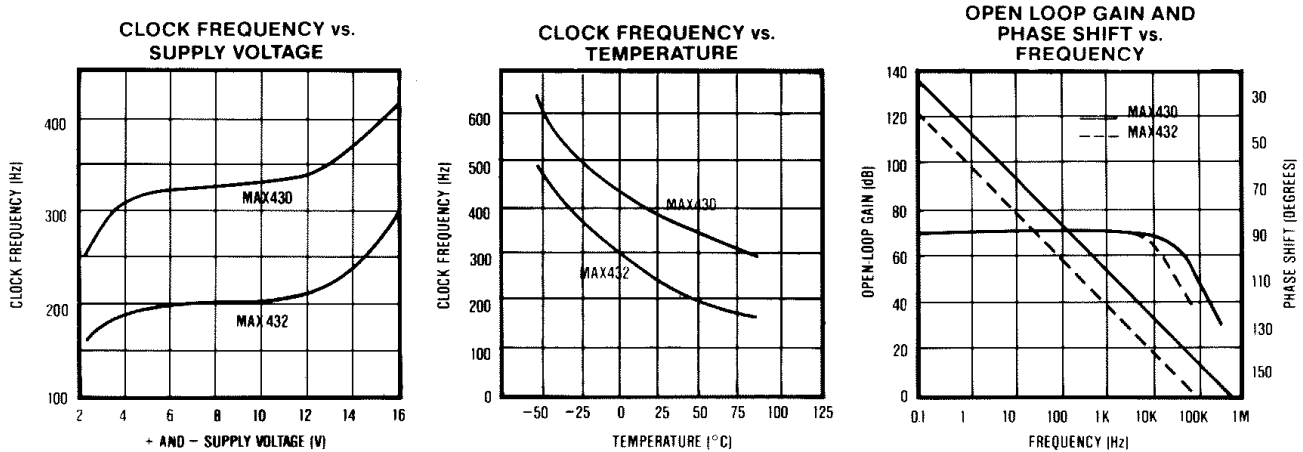

Detailed Description

Amplifier Operation

A block diagram of a MAX430/432 is shown in Figure 2. Internally there is a main signal path amplifier and a separate nulling amp. The main amplifier is in the primary signal path and is continuously connected to the external inputs (+IN, -IN). The nulling amplifier alternately corrects its own offset, and then that of the main amp, as its input switches between the two op-amp inputs. Offset correction is accomplished by means of two compensating FETs in the input stage's bias circuitry (not shown). The offset values that drive these trim FETs are stored for the duration of the correction cycle on two internal capacitors, C1 and C2. Each cycle is controlled by the clock as shown in the timing diagram in Figure 2. An added benefit of the offset correction scheme is that it also provides correction for CMRR, PSRR, and A_{VOL} at low frequencies ($f_{IN} \ll f_{CLK}$).

Internal Clock

An on-chip clock is included on the MAX430/432 to control the operation of the offset correction circuitry. This oscillator is completely self-contained and needs no external components or connections. The internal clock rate is nominally 400Hz on the MAX430 and

250Hz on the MAX432 and cannot be adjusted. If other clock frequencies are desired, refer to the MAX421 or MAX423.

Output Characteristics/Open Loop Gain

The MAX430 typically drives a 10kΩ load from +14.8V to -14.5V when operating with ±15V power supplies. With a 100kΩ or greater load, the output typically swings to within 50mV of each supply rail. The MAX432 low power part will drive 100kΩ typically within 0.4V of each supply. The output swing of the MAX432 is less than the MAX430 for a given load because of a factor of 4 reduction in output stage bias current.

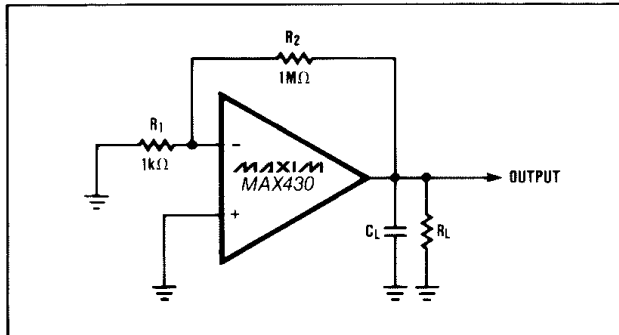

Figure 1. Test Circuit

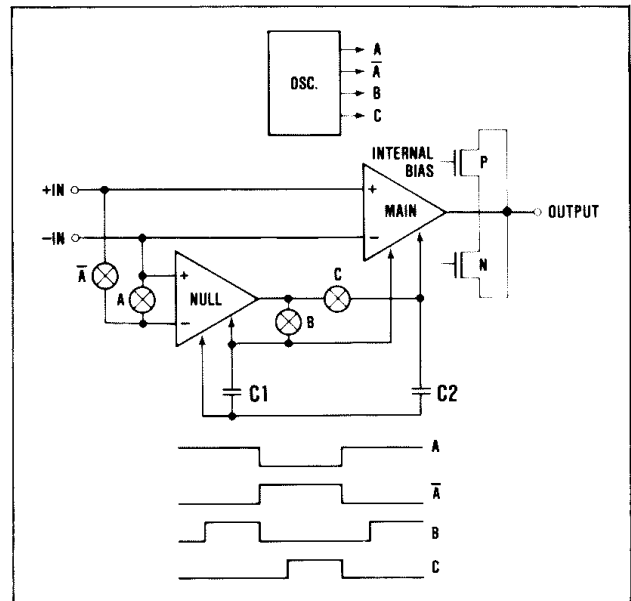

Figure 2. Maxim MAX430 Series Amplifier Block Diagram

$\pm 15V$ Chopper-Stabilized Operational Amplifier

The open loop gain of a MAX430 is load dependent for resistances which are less than $10k\Omega$. The effect is largely due to the impedance of the amplifier's output stage. The gain is about 17dB lower with a $1k\Omega$ load than it is with $10k\Omega$ (MAX430). Even with $1k\Omega$ the gain is typically 120dB, the reduction is insignificant for low frequency applications. In wide-band circuits, however, the best results are achieved with loads of $10k\Omega$ or more where the amplifier's open loop response is a smooth 6dB/octave slope from 0.1Hz to 0.5MHz. Additionally, there is negligible phase shift at the frequency where the null amp is rolled off.

Clock Ripple and Noise

There are two components to MAX430/432 amplifier noise: wide-band noise and clock related ripple. With conventional op-amps, 1/f noise is often a problem in low level applications. This is the case, even with filtering in low frequency applications, because 1/f noise is difficult to remove. Chopper stabilization techniques eliminate 1/f noise in the MAX430/432 to provide superior low frequency performance.

The chopper generates a small amount of ripple at the internal clock frequency. Typically its peak-to-peak input referred amplitude is $15\mu V$. This signal is easily reduced by band limiting the amplifier's response to below the internal oscillator frequency. In wide band limiting the amplifier's response to below the internal oscillatory frequency. In wide band applications, positive and negative going $5\mu s$ pulses, with a typical output amplitude of 15mV, also appear. In circuits which are band limited to 5kHz or less, this noise will not be seen and averages to zero. However,

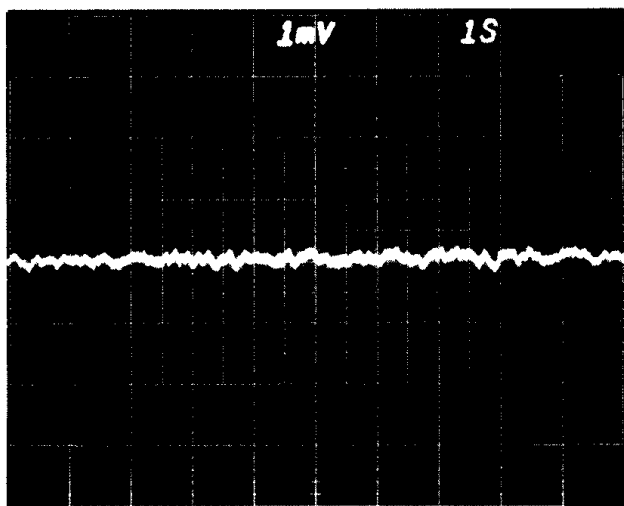

Figure 3. D.C. to 1Hz Noise, $1\mu V$ /vert. div. referred to input, 1 second/horiz. div.

since the pulses are output related, they have little dependence on closed loop gain and are only partially filtered with feedback capacitance around the amplifier. Filtering or band limiting in the circuitry following the amplifier removes this noise.

Intermodulation

In some chopper-stabilization amplifier designs, interaction between the input signal and the chopper frequency sometimes produces intermodulation products in the form of sum and difference signals. If the input frequency and the chop rate are close enough to each other, a difference signal may appear as a DC error at the output. The MAX430 series minimizes these problems with active compensation circuitry that virtually eliminates intermodulation effects and controls the amplifier's open loop gain-phase characteristics as well. With well-behaved open loop parameters, the chopper's circuitry impact on the amplifier's dynamic performance can be ignored in most applications. If chopper oscillator interaction is a problem, then the MAX421/423, which has an externally controllable oscillator, should be used.

Overload Recovery

The MAX430/432 like most chopper-stabilized amplifiers takes more time to recover from input overloads than a conventional op-amp. The reason for this is that the internal offset nulling capacitors are overcharged during input overloads as the amplifier attempts to "correct" the overload condition via the nulling circuitry. Once these capacitors are overcharged, some time is needed for them to return to the proper level. The length of this delay depends on the duration and amplitude of the overload. The worst case time is about 4 seconds for a severely over-driven MAX430. If the recovery takes too long then a MAX421/423 which provides a "Clamp" input to speed overload recovery, should be used.

Application Hints

Plugging Into A Conventional Op-Amp Socket

The MAX430/432 can be powered from supplies ranging from +5V to $\pm 15V$. It can therefore plug into most conventional "741 pinout" op-amp applications. On other op-amps, pins 1, 5, and 8 are used for a variety of functions specific to the amplifier: typically frequency compensation, setting bias, or offset correction. Since the MAX430/432 is internally compensated and its internal chopper removes substantially all of the offset voltage and drift, no connections are required to pins 1, 5 and 8. These pins are not internally connected on the MAX430/432 so that external connections from existing designs will not affect the op-amp's operation.

$\pm 15V$ Chopper-Stabilized Operational Amplifier

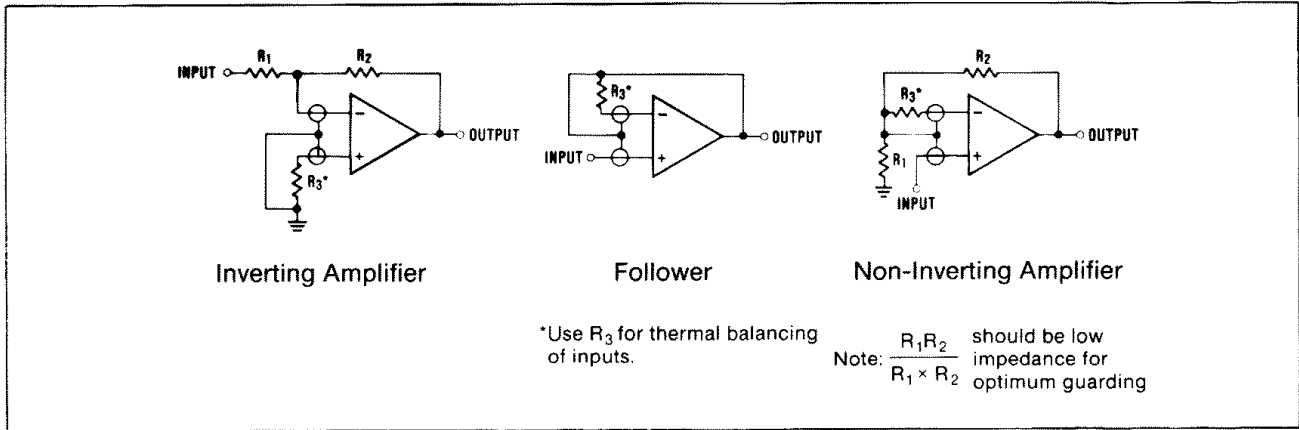

Figure 4. Input Guard Connections

The MAX432 has the same offset and drift specifications as the MAX430 but is designed for low power operation. As a low power op-amp it has been optimized for driving relatively light loads. With output currents above several hundred microamps, there will be some reduction in open loop gain and output swing. The MAX430, however, is guaranteed to swing $\pm 12V$ into a $10k\Omega$ load. The MAX432's load driving limitations should, in general, not be a problem in replacement applications because conventional precision amplifiers are not normally used where they must drive heavy loads. This is because the resulting output stage power dissipation often generates thermally induced error voltages elsewhere in the amplifier.

Single-Supply Operation

The MAX430/432 is well suited for operation in single power supply applications, i.e. circuits that have system ground connected to V^- . With supply voltages of 10 volts or above, the input range is typically from Ground to $V^+ - 1.5V$. At lower supply voltages the lower input range limit is higher (approx. $GND + 0.5V$ at 5V supply). With a single power supply, the amplifier's output will swing to within approximately 50mV of ground and V^+ when driving a $100k\Omega$ load.

Low Voltage Signals

Realizing microvolt offset and nanovolt drift performance goes beyond the selection of a precision amplifier (though it's not a bad start). When trying to amplify very low level signals any number of outside error sources can confuse the measurement. These errors are often indistinguishable from real signal or amplifier error, which of course is why they are a problem.

Thermo-Electric Effect

This property describes how thermocouples measure temperature. In short it states that two dissimilar metals in contact can be expected to generate a voltage. This is fine for thermocouples but is not so useful when pin-to-socket, socket-to-circuit board, and circuit board-to-edge connector junctions all generate signals which can add to input error. The voltage generated in such situations can range from 0.1 to 10's of $\mu V/^\circ C$, many times the offset drift of a MAX430/432. In general such problems are dealt with by minimizing sockets and connectors in low level circuitry and by using components designed for low thermal EMF when connectors, relays, etc. are unavoidable.

±15V Chopper-Stabilized Operational Amplifier

Gradients

The presence of heat in low level circuitry is often not so much a problem as are thermal gradients. Gradients can, for example, cause normally balanced amplifier input connections to be at different temperatures. These connections then generate different thermoelectric voltages that can no longer be completely cancelled by the balanced inputs. The moral then is to minimize thermal gradients by keeping power dissipation and air currents in and around low level circuitry and connections at a minimum.

Thermal Symmetry

Another useful low level technique is to design thermal "symmetry" into the layout. This may mean adding dummy resistors and connections so that the thermal mass, as well as the number of thermoelectric error sources, in an input pair will cancel. It may also involve running input traces near each other and keeping their size the same as well. Thermal "filtering" with small enclosures or even insulation for sensitive areas can also be helpful.

Low Current Signals, Input Guards

Low leakage, high impedance CMOS inputs allow the MAX430 amplifier family to amplify the signals of very high impedance sources. Though the amplifier's input bias current is measured in picoamps, getting the surrounding connections to live up to that specification requires some attention. In applications where picoamp or nanoamp errors can be significant, board leakage either from surface contamination or through the board material itself may be a problem.

Controlling Leakage

Using low leakage board materials and proper cleaning methods after assembly can provide marked reductions in leakage induced errors. Beyond this, conformal coatings can be used to control later surface contamination. In some cases, Teflon insulators and/or circuit board guard rings may be necessary to protect very high impedance nodes. Guard connections for various amplifier configurations are shown in Figure 4. In each case the guard is connected to a low impedance point that is approximately at the same potential as the inputs. Leakage currents from other points on the board are then absorbed by the guard. For best results, guard rings should be used on both sides of the circuit board.

Typical Applications

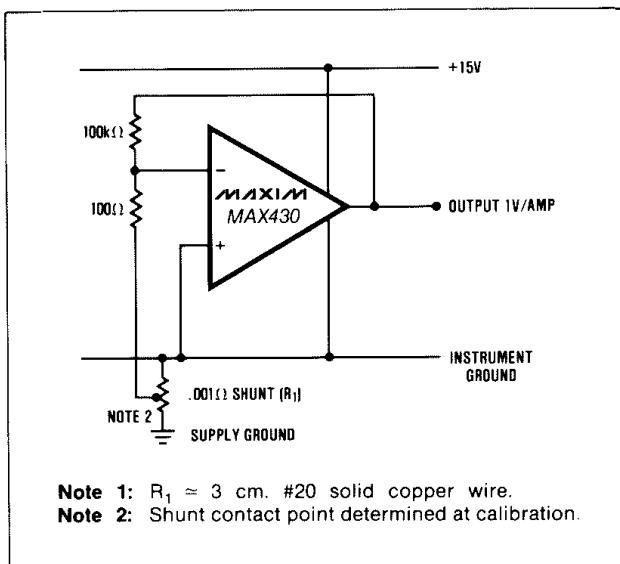

Figure 5. Ultra-low Current Shunt Amp

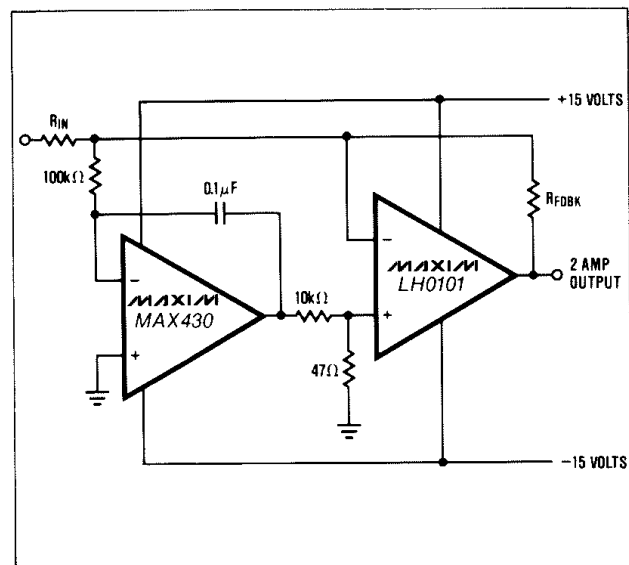

Figure 6. D.C. Stabilized Power Op-Amp. Main amp has 5MHz unity-gain point.

±15V Chopper-Stabilized Operational Amplifier

Typical Applications (continued)

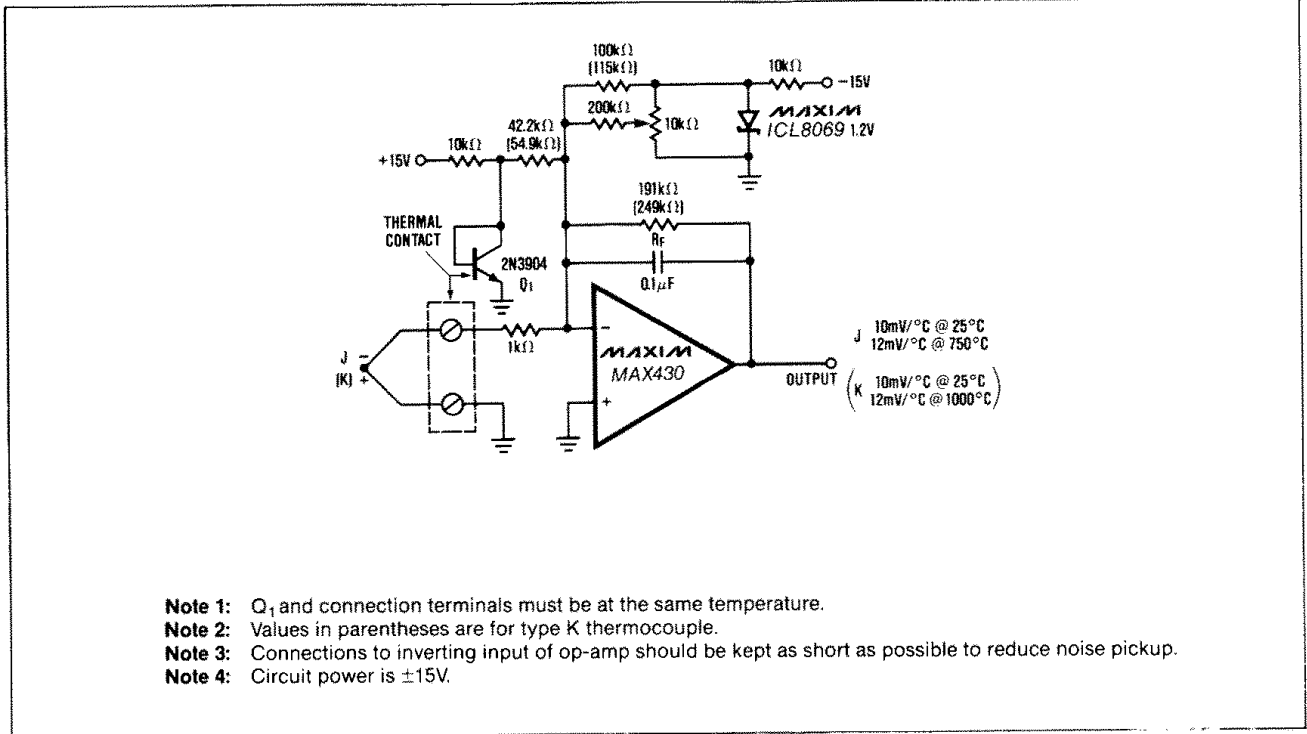

Figure 7. Amplifier with Cold-Junction Compensation for Grounded Thermocouples.

Maxim cannot assume responsibility for use of any circuitry other than circuitry entirely embodied in a Maxim product. No circuit patent licenses are implied. Maxim reserves the right to change the circuitry and specifications without notice at any time.