

DS14C238 Single Supply TIA/EIA-232 4 x 4 Driver/Receiver

General Description

The DS14C238 is a four driver, four receiver device which conforms to the TIA/EIA-232-E standard and CCITT V.28 recommendations. This device eliminates $\pm 12V$ supplies by employing an internal DC-DC converter to generate the necessary output levels from a single +5V supply. Driver slew rate control and receiver noise filtering have also been internalized to eliminate the need for external slew rate control and noise filtering capacitors.

Features

- Conforms to TIA/EIA-232-E and CCITT V.28
- Internal DC-DC converter
- Operates with single +5V supply
- Low power requirement— I_{CC} 10 mA max
- Internal driver slew rate control
- Receiver noise filtering
- Operates above 120 kbits/sec
- Direct replacement for MAX238

Connection Diagram

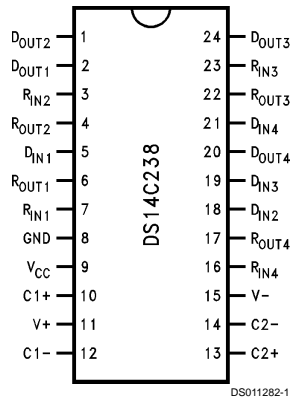

Order Number DS14C238WM
See NS Package Number M24B

Functional Diagram

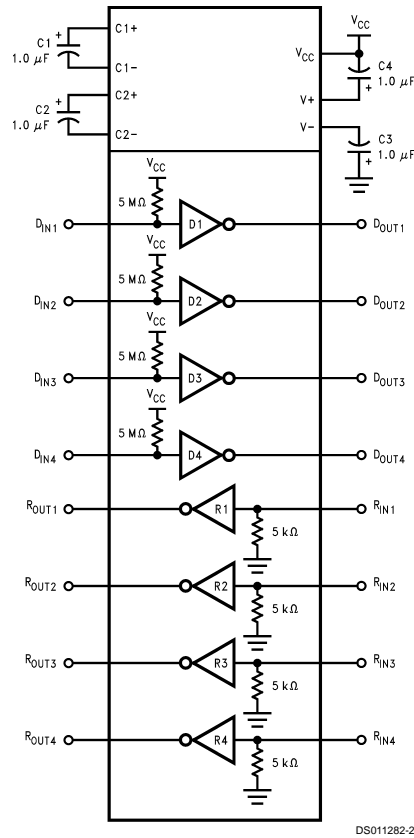

Absolute Maximum Ratings (Note 1)

If Military/Aerospace specified devices are required, please contact the National Semiconductor Sales Office/Distributors for availability and specifications.

Supply Voltage (V_{CC})	-0.3V to +6V
V+ Pin	($V_{CC} - 0.3V$) to +15V
V- Pin	+0.3V to -15V
Driver Input Voltage	-0.3V to ($V_{CC} + 0.3V$)
Driver Output Voltage	(V+ +0.3V) to (V- -0.3V)
Receiver Input Voltage	$\pm 30V$
Receiver Output Voltage	-0.3V to ($V_{CC} + 0.3V$)
Junction Temperature	+150°C
Maximum Package Power Dissipation @ +25°C (Note 6)	
WM Package	1400 mW
Storage Temp. Range	-65°C to +150°C

Lead Temp.

(Soldering, 4 Seconds)

+260°C

Short Circuit Duration (D_{OUT})

Continuous

ESD Rating

(HBM, 1.5 k Ω , 100 pF)

≥ 2.0 kV

Recommended Operating Conditions

	Min	Max	Units
Supply Voltage, V_{CC}	4.5	5.5	V
Operating Free Air Temp. (T_A)			
DS14C238	0	+70	°C

Electrical Characteristics (Note 2)

Over recommended operating conditions, unless otherwise specified.

Symbol	Parameter	Conditions	Min	Typ	Max	Units
DEVICE CHARACTERISTICS						
V+	Positive Power Supply	$R_L = 3\text{ k}\Omega$, C1-C4 = 1.0 μF , $D_{IN} = 0.8V$		9.0		V
V-	Negative Power Supply	$R_L = 3\text{ k}\Omega$, C1-C4 = 1.0 μF , $D_{IN} = 2.0V$		-8.0		V
I_{CC}	Supply Current (V_{CC})	No Load		7.0	10	mA
DRIVER CHARACTERISTICS						
V_{IH}	High Level Input Voltage		2.0		V_{CC}	V
V_{IL}	Low Level Input Voltage		GND		0.8	V
I_{IH}	High Level Input Current	$V_{IN} \geq 2.0V$	-10		+10	μA
I_{IL}	Low Level Input Current	$V_{IN} \leq 0.8V$	-10		+10	μA
V_{OH}	High Level Output Voltage	$R_L = 3\text{ k}\Omega$	5.0	7.4		V
V_{OL}	Low Level Output Voltage			-6.3	-5.0	V
I_{OS+}	Output High Short Circuit Current	$V_O = 0V$, $V_{IN} = 0.8V$	-30	-15	-5.0	mA
I_{OS-}	Output Low Short Circuit Current	$V_O = 0V$, $V_{IN} = 2.0V$				
R_O	Output Resistance	$-2V \leq V_O \leq +2V$, $V_{CC} = \text{GND} = 0V$	300			Ω
RECEIVER CHARACTERISTICS						
V_{TH}	Input High Threshold Voltage			1.9	2.4	V
V_{TL}	Input Low Threshold Voltage		0.8	1.5		V
V_{HY}	Hysteresis		0.2	0.4	1.0	V
R_{IN}	Input Resistance		3.0	4.5	7.0	k Ω
I_{IN}	Input Current	$V_{IN} = +15V$	2.14	3.8	5.0	mA
		$V_{IN} = +3V$	0.43	0.6	+1.0	mA
		$V_{IN} = -3V$	-1.0	-0.6	-0.43	mA
		$V_{IN} = -15V$	-5.0	-3.8	-2.14	mA
V_{OH}	High Level Output Voltage	$V_{IN} = -3V$, $I_O = -3.2\text{ mA}$	3.5	4.5		V
		$V_{IN} = -3V$, $I_O = -20\text{ }\mu\text{A}$	4.0	4.9		V
V_{OL}	Low Level Output Voltage	$V_{IN} = +3V$, $I_O = +2.0\text{ mA}$		0.25	0.4	V

Switching Characteristics (Note 4)

Over recommended operating conditions, unless otherwise specified.

Symbol	Parameter	Conditions	Min	Typ	Max	Units
DRIVER CHARACTERISTICS						
t_{PLH}	Propagation Delay LOW to HIGH	$R_L = 3\text{ k}\Omega$		0.7	4.0	μs
t_{PHL}	Propagation Delay HIGH to LOW	$C_L = 50\text{ pF}$		0.6	4.0	μs
t_{sk}	Skew $ t_{PLH} - t_{PHL} $	(Figures 1, 2)		0.1	1.0	μs
SR1	Output Slew Rate	$R_L = 3\text{ k}\Omega$ to $7\text{ k}\Omega$, $C_L = 50\text{ pF}$	4.0	15	30	$\text{V}/\mu\text{s}$
SR2	Output Slew Rate	$R_L = 3\text{ k}\Omega$, $C_L = 2500\text{ pF}$	3.0	5.0		$\text{V}/\mu\text{s}$
RECEIVER CHARACTERISTICS						
t_{PLH}	Propagation Delay LOW to HIGH	Input Pulse Width $> 10\text{ }\mu\text{s}$		2.0	6.5	μs
t_{PHL}	Propagation Delay HIGH to LOW	$C_L = 50\text{ pF}$		2.8	6.5	μs
t_{sk}	Skew $ t_{PLH} - t_{PHL} $	(Figures 3, 4)		0.8	2.0	μs
t_{NW}	Noise Pulse Width Rejected	(Figures 3, 4)		2.5	1.0	μs

Note 1: "Absolute Maximum Ratings" are those values beyond which the safety of the device cannot be guaranteed. They are not meant to imply that the devices should be operated at these limits. The tables of "Electrical Characteristics" specify conditions for device operation.

Note 2: Current into device pins is defined as positive. Current out of device pins is defined as negative. All voltages are referenced to ground unless otherwise specified.

Note 3: I_{OS+} and I_{OS-} values are for one output at a time. If more than one output is shorted simultaneously, the device power dissipation may be exceeded.

Note 4: Receiver AC input waveform for test purposes: $t_r = t_f = 200\text{ ns}$, $V_{IH} = 3\text{V}$, $V_{IL} = -3\text{V}$, $f = 64\text{ kHz}$ (128 kbits/sec). Driver AC input waveform for test purposes: $t_r = t_f \leq 10\text{ ns}$, $V_{IH} = 3\text{V}$, $V_{IL} = 0\text{V}$, $f = 64\text{ kHz}$ (128 kbits/sec).

Note 5: All typicals are given for $V_{CC} = 5.0\text{V}$ and $T_A = +25^\circ\text{C}$.

Note 6: Ratings apply to ambient temperature at $+25^\circ\text{C}$. Above this temperature derate: WM package $13.5\text{ mW}/^\circ\text{C}$.

Parameter Measurement Information

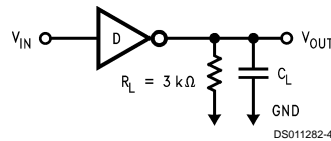

FIGURE 1. Driver Load Circuit

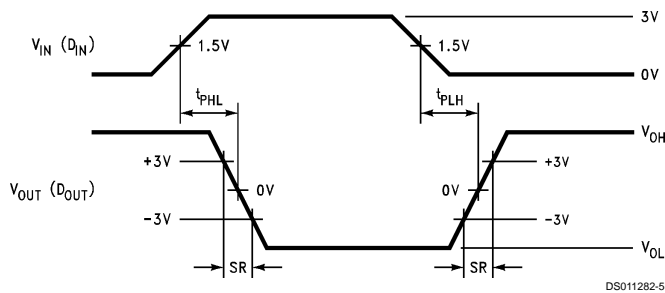

FIGURE 2. Driver Switching Waveform

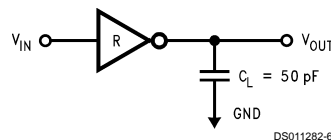

FIGURE 3. Receiver Load Circuit

Parameter Measurement Information (Continued)

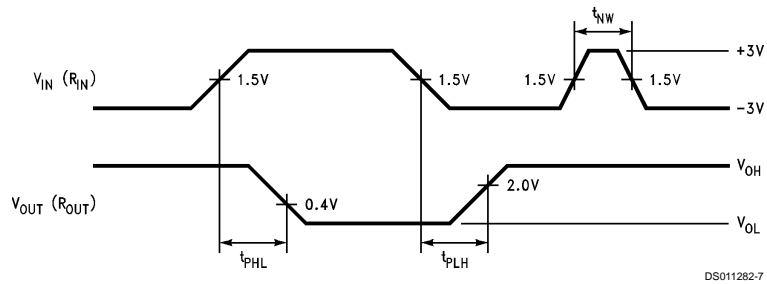

FIGURE 4. Receiver Propagation Delays and Noise Rejection

Pin Descriptions

V_{CC} (pin 9)— Power supply pin for the device, +5V ($\pm 10\%$).

V+ (pin 11)— Positive supply for TIA/EIA-232-E drivers. Recommended external capacitor: C4 = 1.0 μ F (6.3V). This supply is not intended to be loaded externally.

V- (pin 15)— Negative supply for TIA/EIA-232-E drivers. Recommended external capacitor: C3 = 1.0 μ F (16V). This supply is not intended to be loaded externally.

C1+, C1- (pins 10 and 12)— External capacitor connection pins. Recommended capacitor – 1.0 μ F (6.3V).

C2+, C2- (pins 13 and 14)— External Capacitor connection pins. Recommended capacitor – 1.0 μ F (16V).

D_{IN} 1–4 (pins 5, 18, 19, and 21)— Driver input pins are TTL/CMOS compatible. Inputs of unused drivers may be left

open, an internal pull-up resistor (500 k Ω minimum, typically 5 M Ω) pulls input to V_{CC}. Output will be LOW for open inputs.

D_{OUT} 1–4 (pins 2, 1, 24, and 20)— Driver output pins conform to TIA/EIA-232-E levels.

R_{IN1} 1–4 (pins 3, 7, 23, and 16)— Receiver input pins accept TIA/EIA-232-E input voltages (± 15 V). Receivers feature a noise filter and guaranteed hysteresis of 200 mV. Unused receiver input pins may be left open. Internal input resistor (5 k Ω) pulls input LOW, providing a failsafe HIGH output.

R_{OUT} 1–4 (pins 4, 6, 22, and 17)— Receiver output pins are TTL/CMOS compatible. Receiver output HIGH voltage is specified for both CMOS and TTL load conditions.

GND (pin 8)— Ground Pin.

Physical Dimensions inches (millimeters) unless otherwise noted

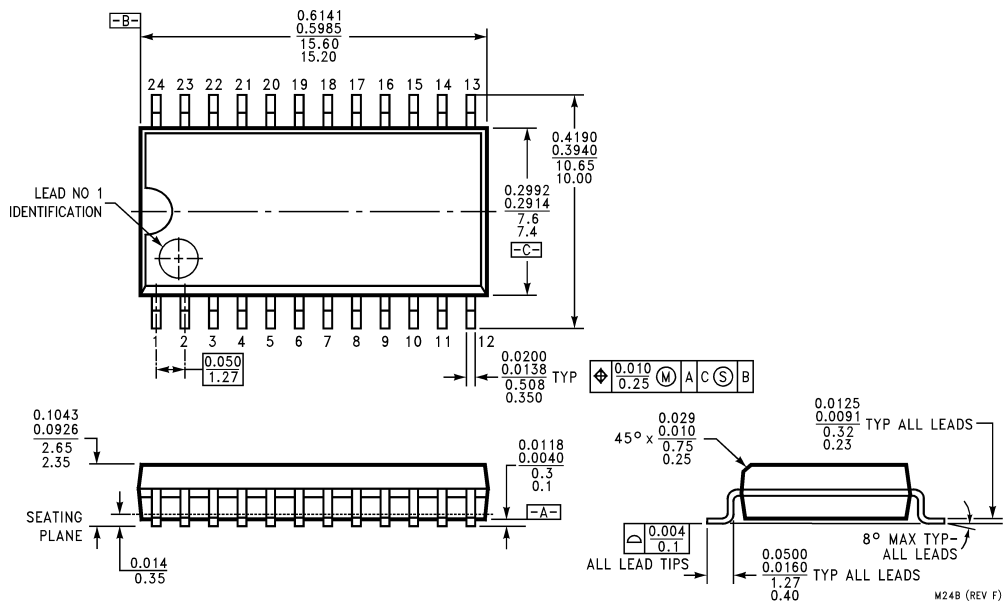

Order Number DS14C238WM
NS Package Number M24B

LIFE SUPPORT POLICY

NATIONAL'S PRODUCTS ARE NOT AUTHORIZED FOR USE AS CRITICAL COMPONENTS IN LIFE SUPPORT DEVICES OR SYSTEMS WITHOUT THE EXPRESS WRITTEN APPROVAL OF THE PRESIDENT AND GENERAL COUNSEL OF NATIONAL SEMICONDUCTOR CORPORATION. As used herein:

1. Life support devices or systems are devices or systems which, (a) are intended for surgical implant into the body, or (b) support or sustain life, and whose failure to perform when properly used in accordance with instructions for use provided in the labeling, can be reasonably expected to result in a significant injury to the user.
2. A critical component is any component of a life support device or system whose failure to perform can be reasonably expected to cause the failure of the life support device or system, or to affect its safety or effectiveness.

 <p>National Semiconductor Corporation Americas Tel: 1-800-272-9959 Fax: 1-800-737-7018 Email: support@nsc.com www.national.com</p>	<p>National Semiconductor Europe Fax: +49 (0) 1 80-530 85 86 Email: europe.support@nsc.com Deutsch Tel: +49 (0) 1 80-530 85 85 English Tel: +49 (0) 1 80-532 78 32 Français Tel: +49 (0) 1 80-532 93 58 Italiano Tel: +49 (0) 1 80-534 16 80</p>	<p>National Semiconductor Asia Pacific Customer Response Group Tel: 65-2544466 Fax: 65-2504466 Email: sea.support@nsc.com</p>	<p>National Semiconductor Japan Ltd. Tel: 81-3-5639-7560 Fax: 81-3-5639-7507</p>
--	---	--	---

National does not assume any responsibility for use of any circuitry described, no circuit patent licenses are implied and National reserves the right at any time without notice to change said circuitry and specifications.

Copyright © Each Manufacturing Company.

All Datasheets cannot be modified without permission.

This datasheet has been download from :

www.AllDataSheet.com

100% Free DataSheet Search Site.

Free Download.

No Register.

Fast Search System.

www.AllDataSheet.com