

6MBP100RA120

IGBT-IPM R series

1200V / 100A 6 in one-package

Features

- Temperature protection provided by directly detecting the junction temperature of the IGBTs
- Low power loss and soft switching
- High performance and high reliability IGBT with overheating protection
- Higher reliability because of a big decrease in number of parts in built-in control circuit



Maximum ratings and characteristics

● Absolute maximum ratings(at Tc=25°C unless otherwise specified)

Item	Symbol	Rating		Unit	
		Min.	Max.		
DC bus voltage	V _{DC}	0	900	V	
DC bus voltage (surge)	V _{DC(surge)}	0	1000	V	
DC bus voltage (short operating)	V _{SC}	200	800	V	
Collector-Emitter voltage	V _{CES}	0	1200	V	
INV Collector current	DC	I _C	-	100	A
	1ms	I _{CP}	-	200	A
	DC	-I _C	-	100	A
	Collector power dissipation	One transistor	P _C	-	735
Junction temperature	T _J	-	150	°C	
Input voltage of power supply for Pre-Driver	V _{CC} *1	0	20	V	
Input signal voltage	V _{in} *2	0	V _Z	V	
Input signal current	I _{in}	-	1	mA	
Alarm signal voltage	V _{ALM} *3	0	V _{CC}	V	
Alarm signal current	I _{ALM} *4	-	15	mA	
Storage temperature	T _{stg}	-40	125	°C	
Operating case temperature	T _{op}	-20	100	°C	
Isolating voltage (Case-Terminal)	V _{iso} *5	-	AC2.5	kV	
Screw torque	Mounting (M5)	-	3.5 *6	N·m	
	Terminal (M5)	-	3.5 *6	N·m	

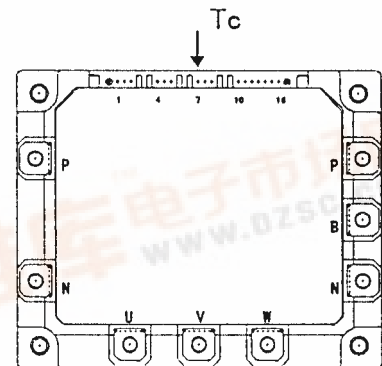

Fig.1 Measurement of case temperature

*1 Apply V_{CC} between terminal No. 3 and 1, 6 and 4, 9 and 7, 11 and 10.

*2 Apply V_{in} between terminal No. 2 and 1, 5 and 4, 8 and 7, 13,14,15 and 10.

*3 Apply V_{ALM} between terminal No. 16 and 10.

*4 Apply I_{ALM} to terminal No. 16.

*5 50Hz/60Hz sine wave 1 minute.

*6 Recommendable Value : 2.5 to 3.0 N·m

● Electrical characteristics of power circuit (at T_c=T_J=25°C, V_{CC}=15V)

Item	Symbol	Condition	Min.	Typ.	Max.	Unit
INV Collector current at off signal input	I _{CES}	V _{CE} =1200V input terminal open	-	-	1.0	mA
Collector-Emitter saturation voltage	V _{CE(sat)}	I _C =100A	-	-	2.6	V
Forward voltage of FWD	V _F	-I _C =100A	-	-	3.0	V



● Electrical characteristics of control circuit(at Tc=Tj=25°C, Vcc=15V)

Item	Symbol	Condition	Min.	Typ.	Max.	Unit
Power supply current of P-line side Pre-driver(one unit)	I _{ccp}	fsw=0 to 15kHz Tc=-20 to 100°C *7	3	-	18	mA
Power supply current of N-line side three Pre-driver	I _{ccn}	fsw=0 to 15kHz Tc=-20 to 100°C *7	10	-	65	mA
Input signal threshold voltage (on/off)	V _{in(th)}	ON	1.00	1.35	1.70	V
		OFF	1.70	2.05	2.40	V
Input zener voltage	V _Z	R _{in} =20k ohm	-	8.0	-	V
Over heating protection temperature level	T _{COH}	VDC=0V, I _c =0A, Case temperature	110	-	125	°C
Hysteresis	T _{CH}		-	20	-	°C
IGBT chips over heating protection temperature level	T _{JOH}	surface of IGBT chips	150	-	-	°C
Hysteresis	T _{JH}		-	20	-	°C
Collector current protection level	INV I _{OC}	T _J =125°C	150	-	-	A
Over current protection delay time (Fig.2)	t _{DOC}	T _J =25°C Fig.2	-	10	-	μs
Under voltage protection level	V _{UV}		11.0	-	12.5	V
Hysteresis	V _H		0.2	-	-	V
Alarm signal hold time	t _{ALM}		1.5	2	-	ms
SC protection delay time	t _{SC}	T _J =25°C Fig.3	-	-	12	μs
Limiting resistor for alarm	R _{ALM}		1425	1500	1575	ohm

*7 Switching frequency of IGBT

● Dynamic characteristics(at Tc=Tj=125°C, Vcc=15V)

Item	Symbol	Condition	Min.	Typ.	Max.	Unit
Switching time (IGBT)	t _{on}	I _C =100A, VDC=600V	0.3	-	-	μs
	t _{off}		-	-	3.6	μs
Switching time (FWD)	t _{rr}	I _F =100A, VDC=600V	-	-	0.4	μs

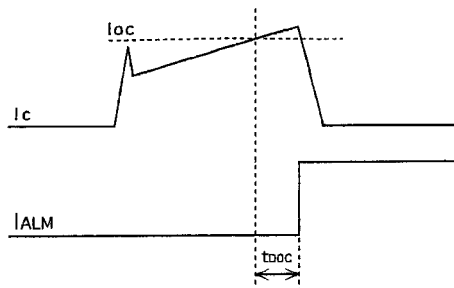

Fig.2 Definition of OC delay time

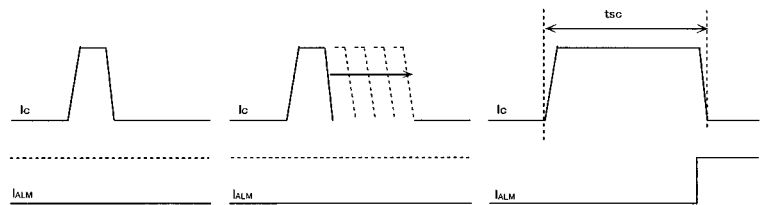

Fig.3 Definition of tsc

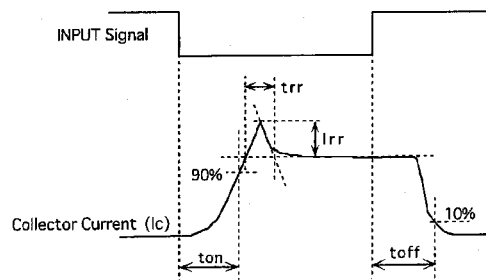

Fig.4 Definition of switching time

● Thermal characteristics(Tc=25°C)

Item	Symbol	Typ.	Max.	Unit	
Junction to Case thermal resistance	INV IGBT	R _{th(j-c)}	-	0.17	°C/W
	FWD	R _{th(j-c)}	-	0.36	°C/W
Case to fin thermal resistance with compound	R _{th(c-f)}	0.05	-	°C/W	

● Recommendable value

Item	Symbol	Min.	Typ.	Max.	Unit	
DC bus voltage	V _{DC}	200	-	800	V	
Operating power supply voltage range of Pre-driver	V _{CC}	13.5	15	16.5	V	
Switching frequency of IPM	f _{sw}	1	-	20	kHz	
Screw torque	Mounting (M5)	-	2.5	-	3.0	N·m
	Terminal (M5)	-	2.5	-	3.0	N·m

Block diagram

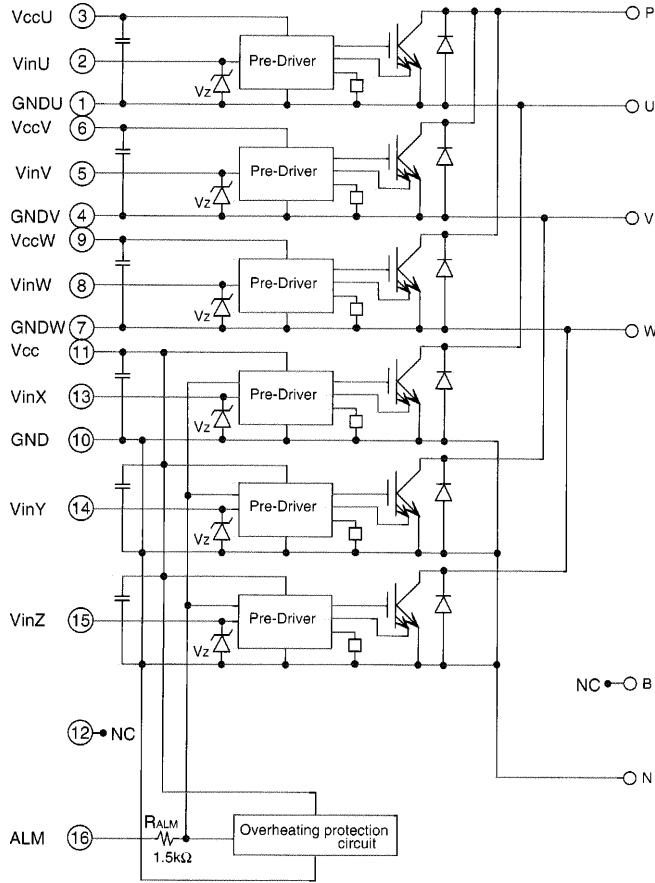

- Pre-drivers include following functions
- a) Amplifier for driver
 - b) Short circuit protection
 - c) Undervoltage lockout circuit
 - d) Over current protection
 - e) IGBT chip over heating protection

Outline drawings, mm

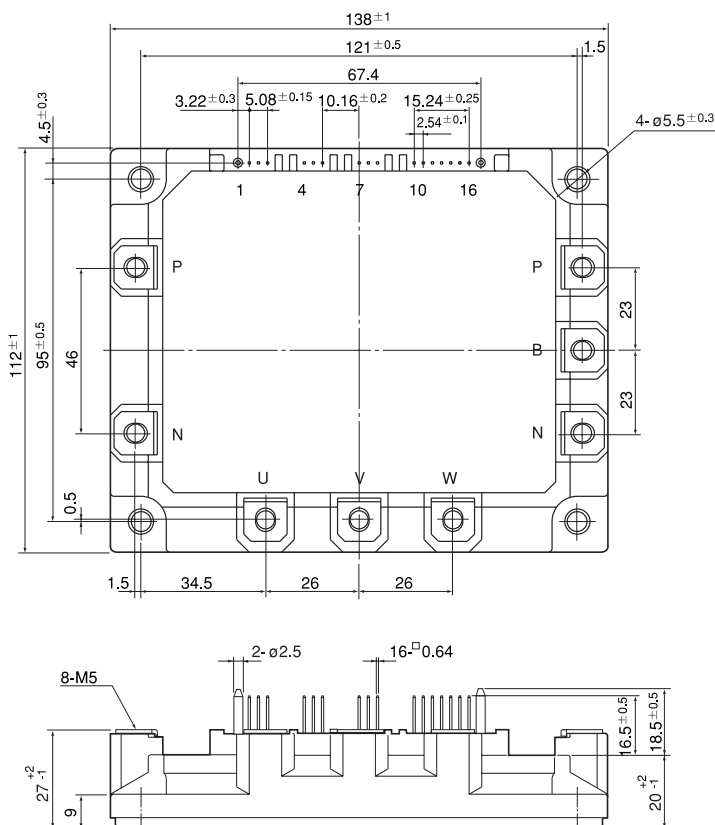

Mass : 920g

Characteristics (Representative)

Control Circuit

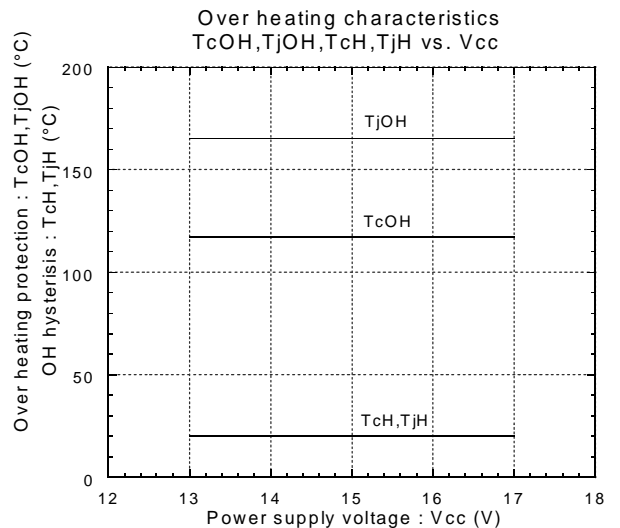
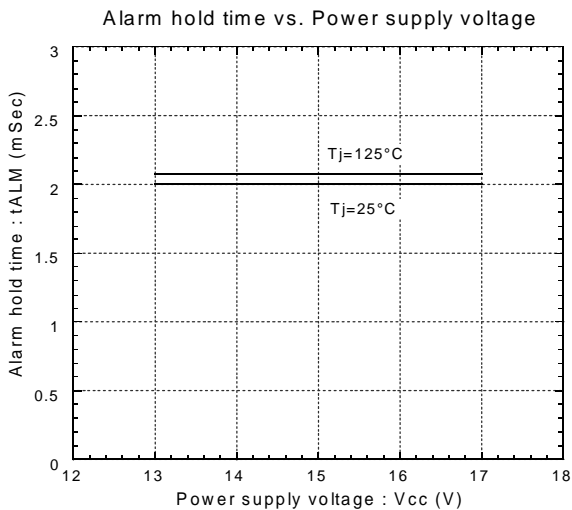
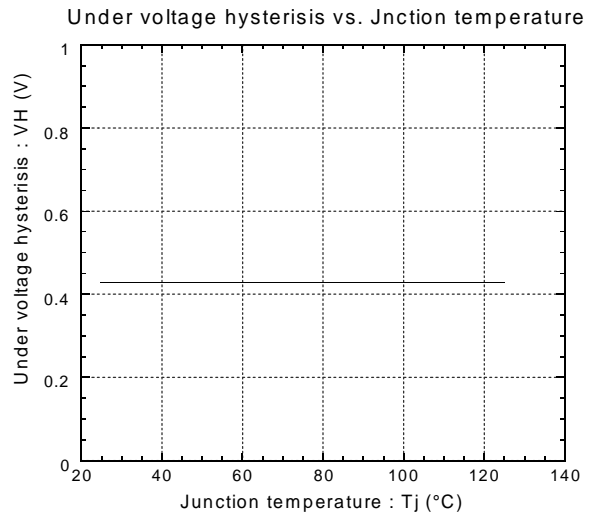
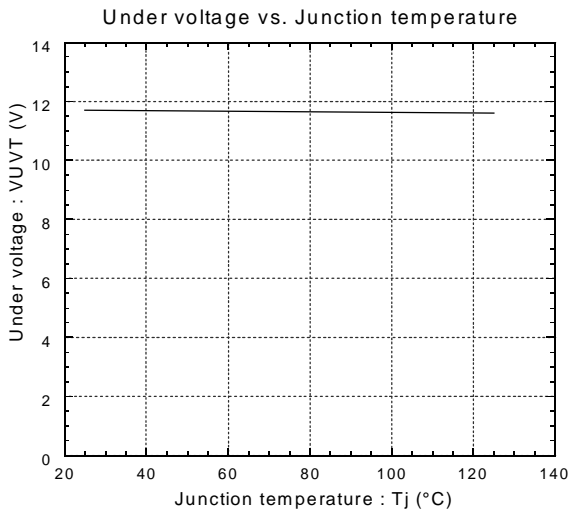
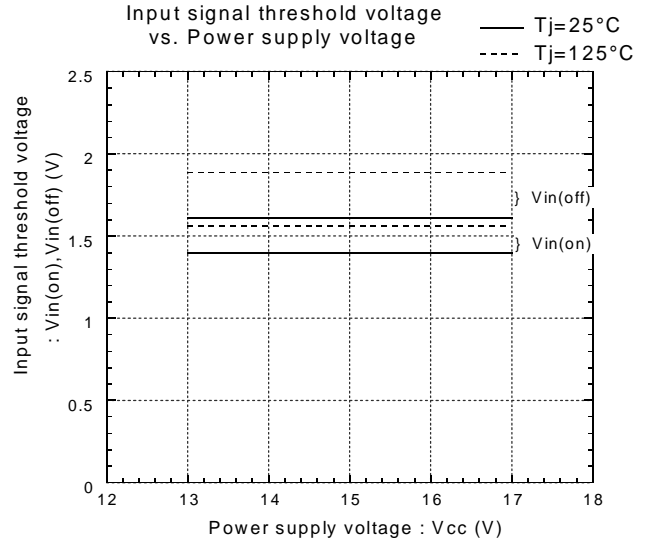
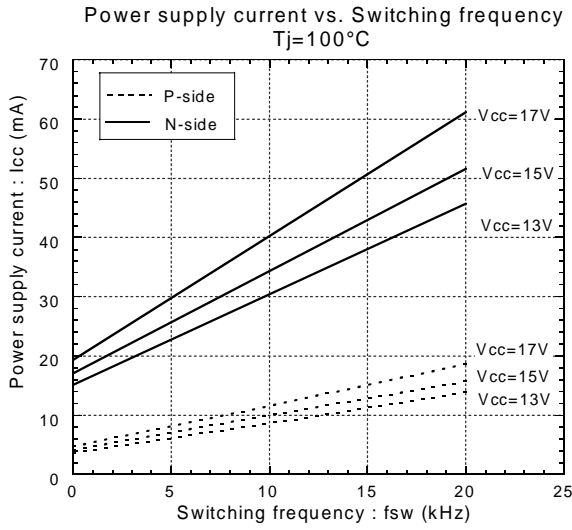

● Inverter

Collector current vs. Collector-Emitter voltage
T_j=25°C

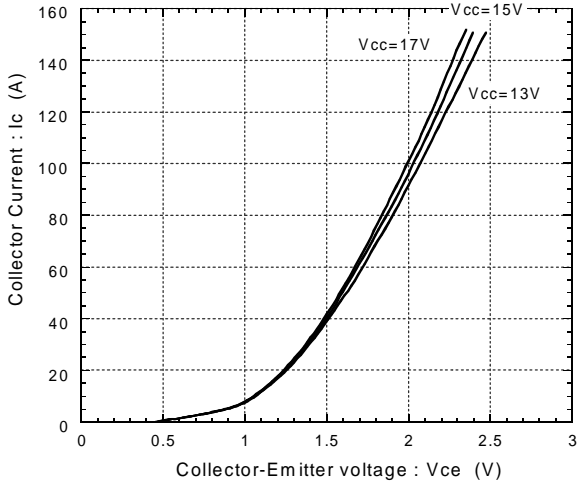

Collector current vs. Collector-Emitter voltage
T_j=125°C

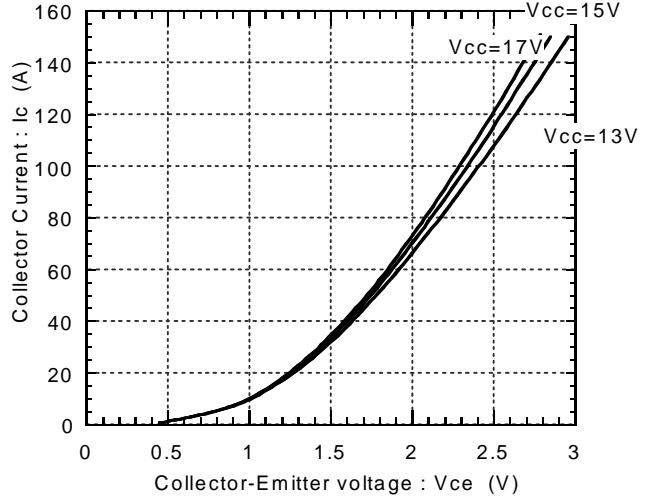

Switching time vs. Collector current
E_{dc}=600V, V_{cc}=15V, T_j=25°C

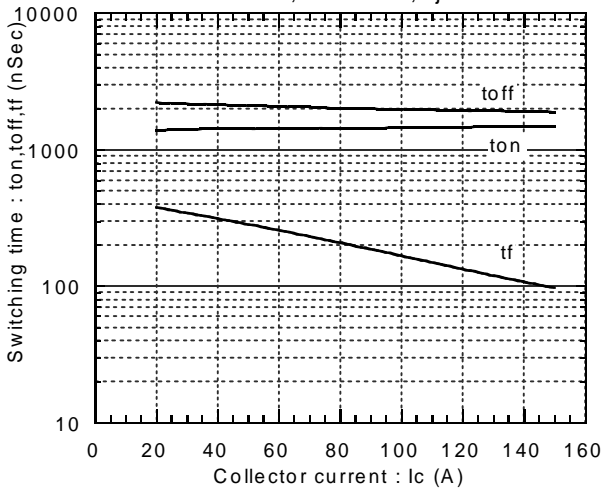

Switching time vs. Collector current
E_{dc}=600V, V_{cc}=15V, T_j=125°C

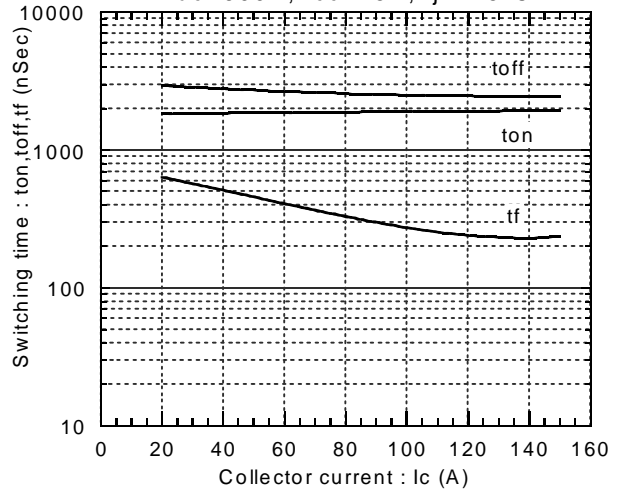

Forward current vs. Forward voltage

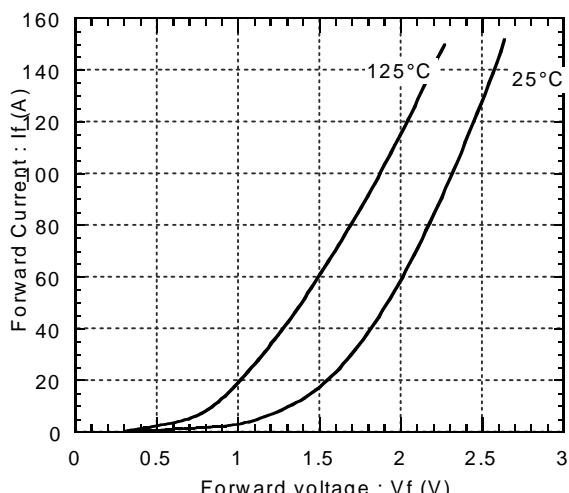

Reverse recovery characteristics
trr, Irr vs. IF

