

**FAIRCHILD**  
SEMICONDUCTOR™

November 1984  
Revised July 1999

## 74F04 Hex Inverter

### General Description

This device contains six independent gates, each of which performs the logic INVERT function.

### Ordering Code:

| Order Number | Package Number | Package Description   |
|--------------|----------------|---|
| 74F04SC      | M14A           | 14-Lead Small Outline Integrated Circuit (SOIC), JEDEC MS-120, 0.150 Narrow |
| 74F04SJ      | M14D           | 14-Lead Small Outline Package (SOP), EIAJ TYPE II, 5.3mm Wide               |
| 74F04PC      | N14A           | 14-Lead Plastic Dual-In-Line Package (PDIP), JEDEC MS-001, 0.300 Wide       |

Devices also available in Tape and Reel. Specify by appending the suffix letter "X" to the ordering code.

### Logic Symbol

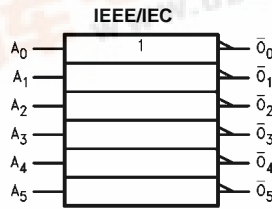

### Connection Diagram

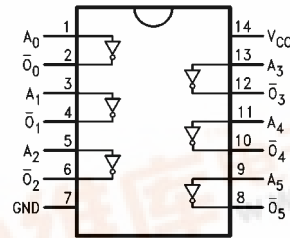

### Unit Loading/Fan Out

| Pin Names   | Description | U.L.<br>HIGH/LOW | Input $I_{IH}/I_{IL}$<br>Output $I_{OH}/I_{OL}$ |
|-------------|-------------|------------------|---|
| $A_n$       | Inputs      | 1.0/1.0          | 20 $\mu$ A/-0.6 mA                              |
| $\bar{O}_n$ | Outputs     | 50/33.3          | -1 mA/20 mA                                     |

74F04 Hex Inverter



**Absolute Maximum Ratings** (Note 1)

|  |                                      |
|--|--------------------------------------|
| Storage Temperature  | -65°C to +150°C                      |
| Ambient Temperature under Bias   | -55°C to +125°C                      |
| Junction Temperature under Bias  | -55°C to +150°C                      |
| V <sub>CC</sub> Pin Potential to Ground Pin                            | -0.5V to +7.0V                       |
| Input Voltage (Note 2)   | -0.5V to +7.0V                       |
| Input Current (Note 2)   | -30 mA to +5.0 mA                    |
| Voltage Applied to Output<br>in HIGH State (with V <sub>CC</sub> = 0V) |                                      |
| Standard Output  | -0.5V to V <sub>CC</sub>             |
| 3-STATE Output   | -0.5V to +5.5V                       |
| Current Applied to Output<br>in LOW State (Max)                        | twice the rated I <sub>OL</sub> (mA) |
| ESD Last Passing Voltage (Min)   | 4000V                                |

**Recommended Operating Conditions**

|                              |                |
|------------------------------|----------------|
| Free Air Ambient Temperature | 0°C to +70°C   |
| Supply Voltage               | +4.5V to +5.5V |

**Note 1:** Absolute maximum ratings are values beyond which the device may be damaged or have its useful life impaired. Functional operation under these conditions is not implied.

**Note 2:** Either voltage limit or current limit is sufficient to protect inputs.

**DC Electrical Characteristics**

| Symbol           | Parameter                         | Min                                       | Typ        | Max  | Units | V <sub>CC</sub> | Conditions   |
|------------------|-----------------------------------|---|------------|------|-------|-----------------|--|
| V <sub>IH</sub>  | Input HIGH Voltage                | 2.0                                       |            |      | V     |                 | Recognized as a HIGH Signal                          |
| V <sub>IL</sub>  | Input LOW Voltage                 |   |            | 0.8  | V     |                 | Recognized as a LOW Signal                           |
| V <sub>CD</sub>  | Input Clamp Diode Voltage         |   |            | -1.2 | V     | Min             | I <sub>IN</sub> = -18 mA                             |
| V <sub>OH</sub>  | Output HIGH Voltage               | 10% V <sub>CC</sub><br>5% V <sub>CC</sub> | 2.5<br>2.7 |      | V     | Min             | I <sub>OH</sub> = -1 mA<br>I <sub>OH</sub> = -1 mA   |
| V <sub>OL</sub>  | Output LOW Voltage                | 10% V <sub>CC</sub>                       |            | 0.5  | V     | Min             | I <sub>OL</sub> = 20 mA                              |
| I <sub>IH</sub>  | Input HIGH Current                |   |            | 5.0  | μA    | Max             | V <sub>IN</sub> = 2.7V                               |
| I <sub>BVI</sub> | Input HIGH Current Breakdown Test |   |            | 7.0  | μA    | Max             | V <sub>IN</sub> = 7.0V                               |
| I <sub>CEX</sub> | Output HIGH Leakage Current       |   |            | 50   | μA    | Max             | V <sub>OUT</sub> = V <sub>CC</sub>                   |
| V <sub>ID</sub>  | Input Leakage Test                | 4.75                                      |            |      | V     | 0.0             | I <sub>ID</sub> = 1.9 μA<br>All other pins grounded  |
| I <sub>OD</sub>  | Output Leakage Circuit Current    |   |            | 3.75 | μA    | 0.0             | V <sub>IOD</sub> = 150 mV<br>All other pins grounded |
| I <sub>IL</sub>  | Input LOW Current                 |   |            | -0.6 | mA    | Max             | V <sub>IN</sub> = 0.5V                               |
| I <sub>OS</sub>  | Output Short-Circuit Current      | -60                                       |            | -150 | mA    | Max             | V <sub>OUT</sub> = 0V                                |
| I <sub>CCH</sub> | Power Supply Current              |   | 2.8        | 4.2  | mA    | Max             | V <sub>O</sub> = HIGH                                |
| I <sub>CCL</sub> | Power Supply Current              |   | 10.2       | 15.3 | mA    | Max             | V <sub>O</sub> = LOW                                 |

**AC Electrical Characteristics**

| Symbol           | Parameter                     | T <sub>A</sub> = +25°C<br>V <sub>CC</sub> = +5.0V<br>C <sub>L</sub> = 50 pF |     |     | T <sub>A</sub> = -55°C to +125°C<br>V <sub>CC</sub> = +5.0V<br>C <sub>L</sub> = 50 pF |     | T <sub>A</sub> = 0°C to +70°C<br>V <sub>CC</sub> = +5.0V<br>C <sub>L</sub> = 50 pF |     | Units |
|------------------|-------------------------------|---|-----|-----|---|-----|--|-----|-------|
|                  |                               | Min   | Typ | Max | Min   | Max | Min  | Max |       |
| t <sub>PLH</sub> | Propagation Delay             | 2.4   | 3.7 | 5.0 | 2.0   | 7.0 | 2.4  | 6.0 | ns    |
| t <sub>PHL</sub> | A <sub>n</sub> to $\bar{O}_n$ | 1.5   | 3.2 | 4.3 | 1.5   | 6.5 | 1.5  | 5.3 |       |

**Physical Dimensions** inches (millimeters) unless otherwise noted

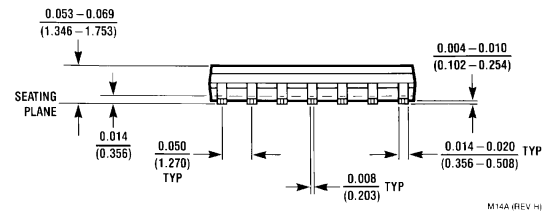
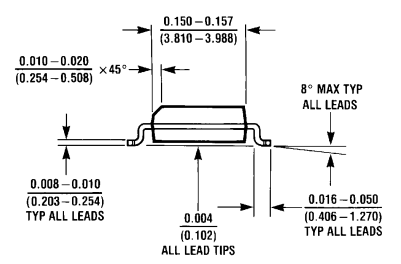
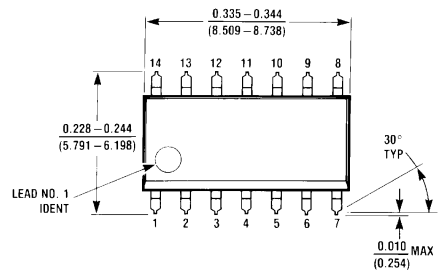

M14A (REV H)

**14-Lead Small Outline Integrated Circuit (SOIC), JEDEC MS-120, 0.150 Narrow  
Package Number M14A**

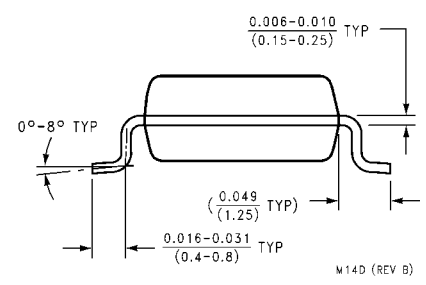
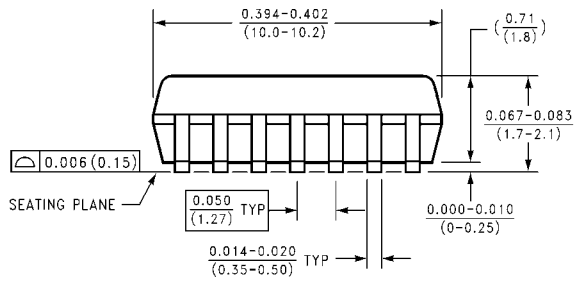
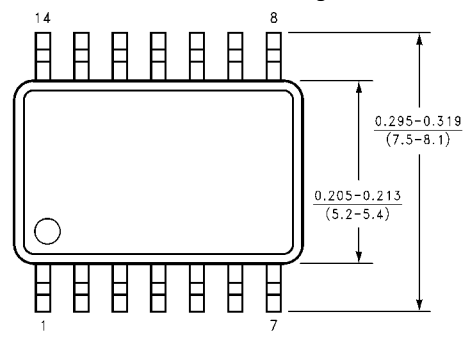

M14D (REV B)

**14-Lead Small Outline Package (SOP), EIAJ TYPE II, 5.3mm Wide  
Package Number M14D**

**Physical Dimensions** inches (millimeters) unless otherwise noted (Continued)

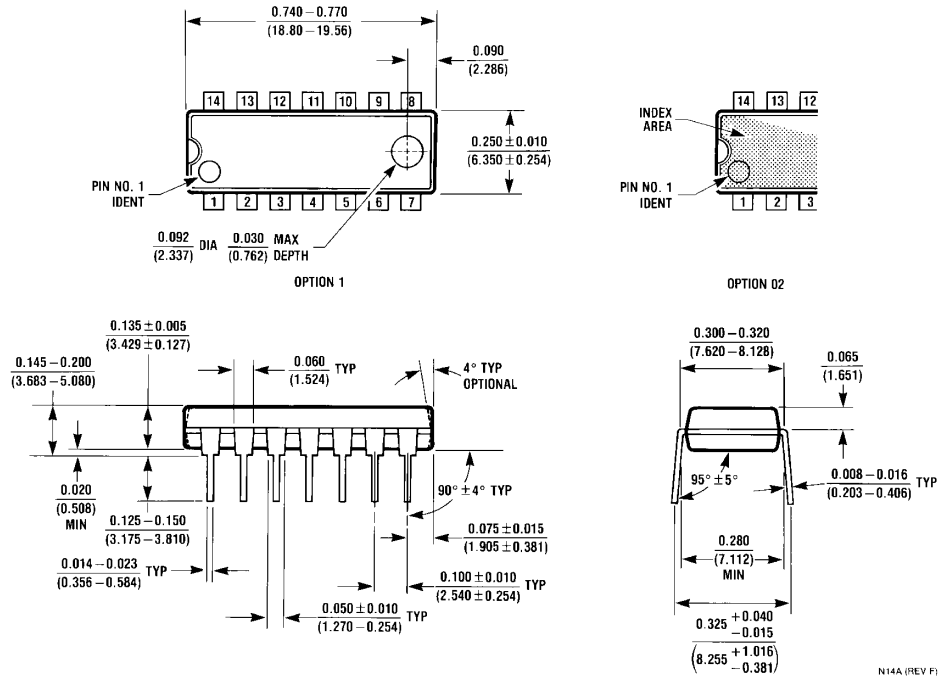

14-Lead Plastic Dual-In-Line Package (PDIP), JEDEC MS-001, 0.300 Wide Package Number N14A

N14A (REV F)

Fairchild does not assume any responsibility for use of any circuitry described, no circuit patent licenses are implied and Fairchild reserves the right at any time without notice to change said circuitry and specifications.

**LIFE SUPPORT POLICY**

FAIRCHILD'S PRODUCTS ARE NOT AUTHORIZED FOR USE AS CRITICAL COMPONENTS IN LIFE SUPPORT DEVICES OR SYSTEMS WITHOUT THE EXPRESS WRITTEN APPROVAL OF THE PRESIDENT OF FAIRCHILD SEMICONDUCTOR CORPORATION. As used herein:

1. Life support devices or systems are devices or systems which, (a) are intended for surgical implant into the body, or (b) support or sustain life, and (c) whose failure to perform when properly used in accordance with instructions for use provided in the labeling, can be reasonably expected to result in a significant injury to the user.
2. A critical component in any component of a life support device or system whose failure to perform can be reasonably expected to cause the failure of the life support device or system, or to affect its safety or effectiveness.

[www.fairchildsemi.com](http://www.fairchildsemi.com)