



LM386 Low Voltage Audio Power Amplifier

The LM386 is a power amplifier designed for use in low voltage consumer applications. The gain is internally set to 20 to keep external part count low, but the addition of an external resistor and capacitor between pins 1 and 8 will increase the gain to any value up to 200.

The inputs are ground referenced while the output is automatically biased to one half the supply voltage. The quiescent power drain is only 24 milliwatts when operating from a 6 volt supply, making the LM386 ideal for battery operation.

Absolute Maximum Ratings (Ta = 25 °C)

Supply Voltage	V ⁺	15V
Power Dissipation	P _D (D-Type)	700mW
	(S-Type)	300mW
Input Voltage Range	V _{IN}	± 0.4V
Operating Temperature Range	T _{OPr}	0~+70°C
Storage Temperature Range	T _{stg}	-40~+125°C

Package Outline

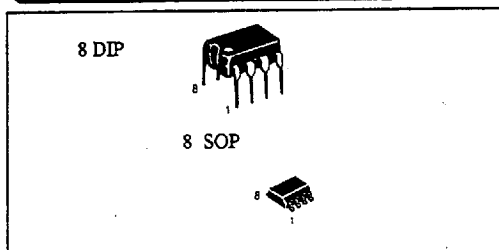

Features

- Battery operation
- Minimum external parts
- Wide supply voltage range 4-12 Volt
- Low quiescent current drain 4mA
- Voltage gains from 20 to 200
- Ground referenced input
- self-centering output quiescent voltage
- Low distortion
- Eight pin dual-in-line package

Applications

- AM-FM radio amplifiers
- Portable tape player amplifiers
- Intercoms
- TV sound systems
- Line drivers
- Ultrasonic drivers
- Small servo drivers
- Power converters

Equivalent Circuit

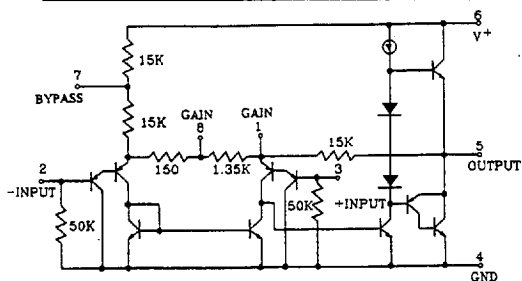

Connection Diagram

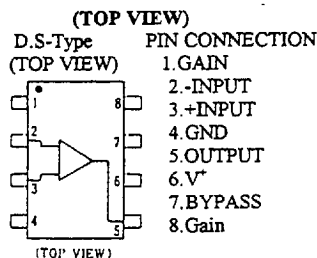

Electrical Characteristics (T_A=25°C)

Parameter	Conditions	Min.	Typ.	Max.	Units
Quiescent Circuit Current (I _Q)	V _{IN} =0		4	8	mA
Output Power (P _{OUT})	V _S =6V, R _L =8Ω, THD=10%	250	325		mW
	V _S =9V, R _L =8Ω, THD=10%	500	700		mW
Voltage Gain (A _v)	V _S =6V, f=1KHz		26		dB
D-Type	10μ F from Pin 1 to 8		46		dB
Bandwidth (BW) D-Type	V _S =6V, Pins 1 and 8 Open		300		KHz
	10μ F from Pin 1 to 8		60		KHz
Total Harmonic Distortion (THD) (D-Type)	V _S =6V, R _L =8Ω, P _{OUT} =125mW f=1KHz, Pins 1 and 8 open		0.2		%
Power Supply Rejection Ratio (PSRR)	V _S =6V, f=1KHz, C _{BYPASS} =10μ F Pins 1 and 8 Open. Referred to Output		50		dB
Input Resistance (R _{IN})			50		KΩ
Input Bias Current (I _{BIAS})	V _S =6V, Pins 2 and 3 Open		250		nA

(note 1) Set the maximum junction temperature to 125°C and reduce the thermal resistance to 143°C/W when the ambient temperature is high.

(note 2) Insert a 10Ω resistor and 0.05μ F capacitor in series to ground terminal from pin 5.

Typical Application

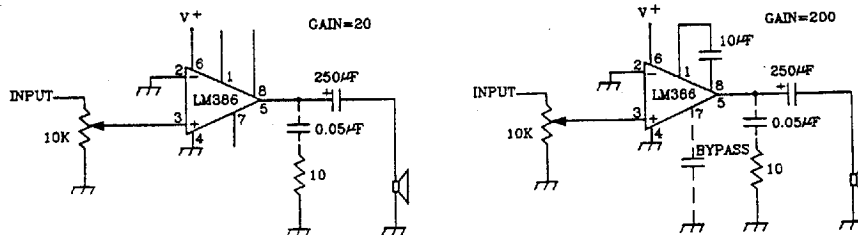

Power Dissipation vs Ambient Temperature

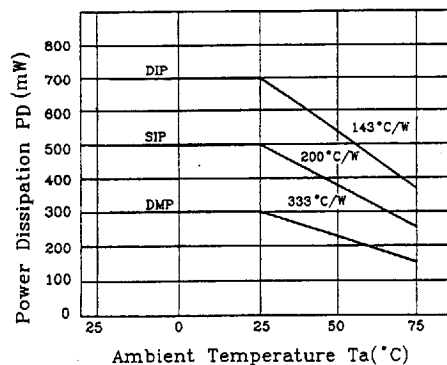

Typical Applications

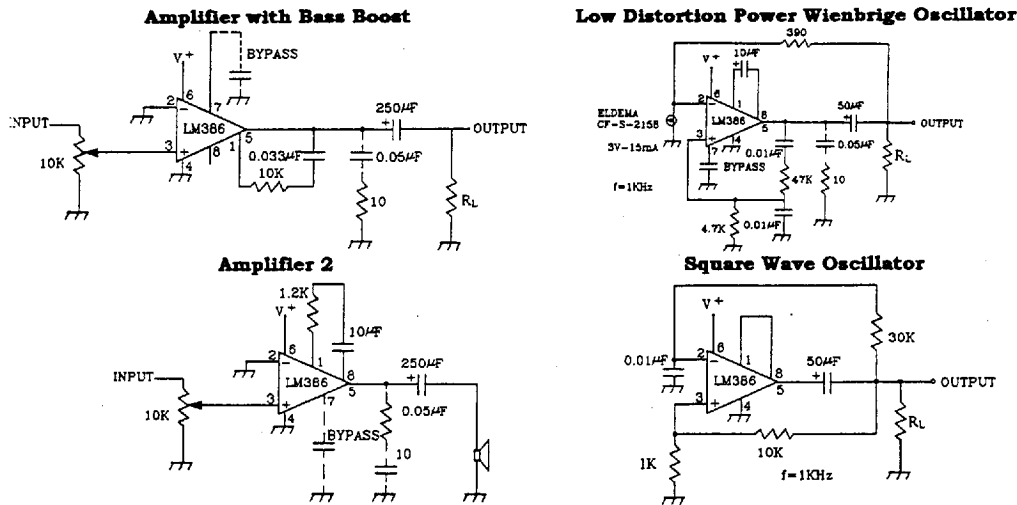

Application Hints

GAIN CONTROL

To make the LM386 a more versatile amplifier, two pins (1 and 8) are provided for gain control. With pins 1 to 8 open the 1.35KΩ resistor sets the gain at 20 (26dB). If a capacitor is put from pin 1 to 8, bypassing the 1.35 KΩ resistor, the gain will go up to 200 (46 dB). If a resistor is placed in series with the capacitor, the gain can be set to any value from 20 to 200. Gain control can also be done by capacitively coupling a resistor (or FET) from pin 1 to ground.

Additional external components can be placed in parallel with the internal feedback resistors to tailor the gain and frequency response for individual applications. For example, we can compensate poor speaker bass response by frequency shaping the feedback path. This is done with a series RC from pin 1 to 5 (paralleling the internal 15 KΩ resistor). For 6 dB effective bass boost: $R = 15 K\Omega$, the lowest values for good stable operation is $R_{min} = 10 K\Omega$ if pin 8 is open. If pins 1 and 8 are bypassed then R as low 2 KΩ can be used. This restriction is because the amplifier is only compensated for closed-loop gains greater than 9.

INPUT BIASING

The schematic shows that both inputs are biased to ground with a 50 KΩ resistor. The base current of the input transistors is about 250nA, so the inputs are at about 12.5mV when left open. If the dc source resistance driving the LM386 is higher than 250 KΩ it will contribute very little additional offset (about 2.5mV at the input, 50mV at the output). If the dc source resistance is less than 10 KΩ, then shorting the unused input to ground will keep the offset low (about 2.5mV at the input, 50mV at the output). For dc source resistances between these values we can eliminate excess offset by putting a resistor from the unused input to ground, equal in value to the dc source resistance. Of course all offset problems are eliminated if the input is capacitively coupled.

When using the LM386 will higher gains (bypassing the 1.35 KΩ resistor between pins 1 and 8) it is necessary to bypass the unused input, preventing degradation of gain and possible instabilities. This is done with a 0.1μF capacitor or a short to ground depending on the dc source resistance on the driven input.

Typical Applications (Ta=25°C)

Quiescent Current vs. Supply Voltage

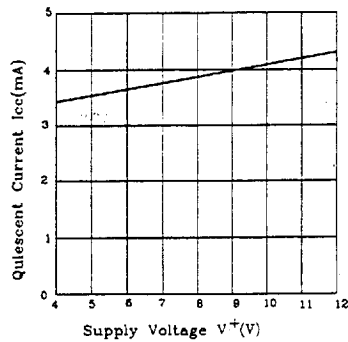

Maximum Output Voltage Swing vs. Supply Voltage

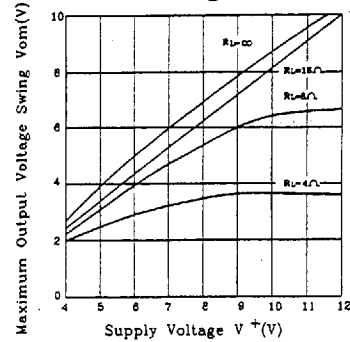

Voltage Gain vs. Frequency

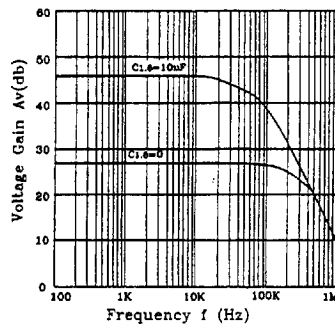

Power Supply Rejection Ratio vs. Frequency (V⁺=6V, A_v=26dB)

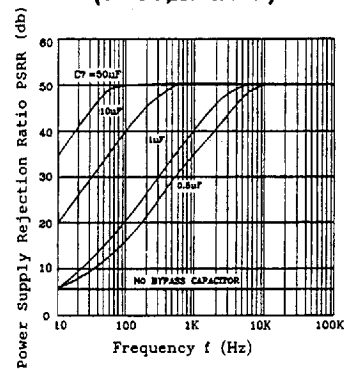

Total Harmonic Distortion vs. Frequency (V⁺=6V, R_L=8Ω, P_o=125mW, A_v=26dB)

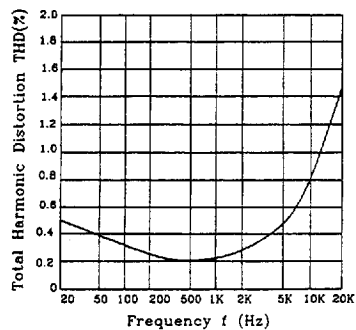

Total Harmonic Distortion vs. Output Power (V⁺=6V, R_L=8Ω, f=1KHz)

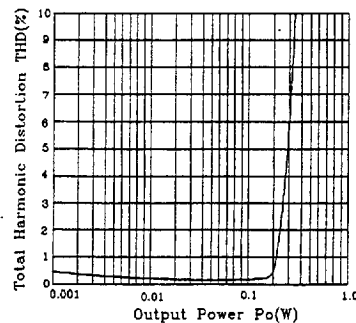

Typical Characteristics (Ta=25°C)

Power Dissipation vs. Output Power (RL=4Ω)

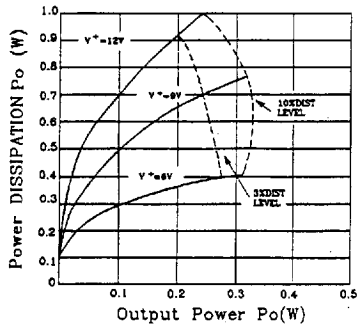

Power Dissipation vs. Output Power (RL=8Ω)

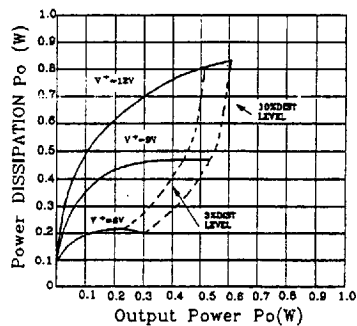

Power Dissipation vs. Output Power (RL=16Ω)

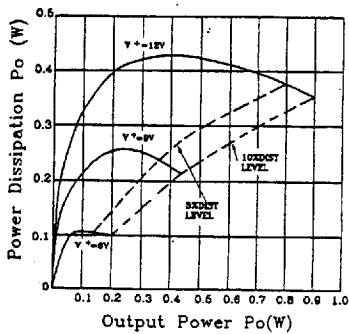

Frequency Response with Base Boost

