

- **Compatible with TTL Inputs**
- **High-Speed Switching . . . 1 Mbit/s Typ**
- **Bandwidth . . . 2 MHz Typ**
- **High Common-Mode Transient Immunity . . . 1000 V/μs Typ**
- **High-Voltage Electrical Insulation . . . 3000 Vdc Min**
- **Open-Collector Output**
- **UL Recognized . . . File Number 65085**

6N135, 6N136, OR HCPL4502 PACKAGE
(TOP VIEW)

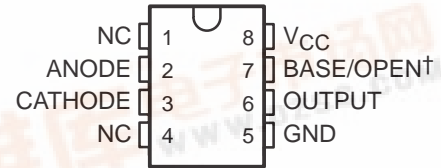

† Terminal 7 is BASE on the 6N135 and 6N136 and OPEN on the HCPL4502

NC – No internal connection

description

These high-speed optocouplers are designed for use in analog or digital interface applications that require high-voltage isolation between the input and output. Applications include line receivers that require high common-mode transient immunity, and analog or logic circuits that require input-to-output electrical isolation.

The 6N135, 6N136, and HCPL4502 optocouplers each consists of a light-emitting diode and an integrated photon detector composed of a photodiode and an open-collector output transistor. Separate connections are provided for the photodiode bias and the transistor-collector output. This feature, which reduces the transistor base-to-collector capacitance, results in speeds up to one hundred times that of a conventional phototransistor optocoupler.

The 6N135 is designed for TTL/CMOS, TTL/LSTTL, and wide-band analog applications.

The 6N136 and HCPL4502 are designed for high-speed TTL/TTL applications. The HCPL4502 has no base connection.

schematic

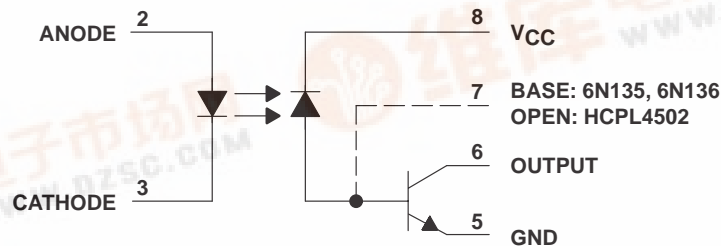

6N135, 6N136, HCPL4502 OPTOCOUPPLERS/OPTOISOLATORS

SOES022A – JULY 1986 – REVISED APRIL 1998

absolute maximum ratings at 25°C free-air temperature (unless otherwise noted)†‡

Supply and output voltage range, V_{CC} and V_O	-0.5 V to 15 V
Reverse input voltage	5 V
Emitter-base reverse voltage	5 V
Peak input forward current (pulse duration = 1 ms, 50% duty cycle, see Note 1)	50 mA
Peak transient input forward current (pulse duration 1 μ s, 300 Hz)	1 A
Average forward input current(see Note 2)	25 mA
Peak output current	16 mA
Average output current	8 mA
Base current	5 mA
Input power dissipation at (or below) 70°C free-air temperature (see Note 3)	45 mW
Output power dissipation at (or below) 70°C free-air temperature (see Note 4)	100 mW
Storage temperature range, T_{stg}	-55°C to 125°C
Operating free-air temperature range, T_A	-55°C to 100°C
Lead temperature 1,6 mm (1/16 inch) from case for 10 seconds	260°C

† Stresses beyond those listed under “absolute maximum ratings” may cause permanent damage to the device. These are stress ratings only, and functional operation of the device at these or any other conditions beyond those indicated under “recommended operating conditions” is not implied. Exposure to absolute-maximum-rated conditions for extended periods may affect device reliability.

‡ JEDEC registered data for 6N135 and 6N136

- NOTES:
1. Derate linearly above 70°C free-air temperature at the rate of 1.67 mA/°C.
 2. Derate linearly above 70°C free-air temperature at the rate of 0.83 mA/°C.
 3. Derate linearly above 70°C free-air temperature at the rate of 1.50 mW/°C.
 4. Derate linearly above 70°C free-air temperature at the rate of 3.33 mW/°C.

6N135, 6N136, HCPL4502 OPTOCOUPLEDERS/OPTOISOLATORS

SOES022A – JULY 1986 – REVISED APRIL 1998

electrical characteristics over operating free-air temperature range of 0°C to 70°C (unless otherwise noted)

PARAMETER		TEST CONDITIONS		6N135		6N136, HCPL4502		UNIT
				MIN	TYP†	MAX	MIN	
V_F ‡	Input forward voltage	$I_F = 16 \text{ mA}$, $T_A = 25^\circ\text{C}$		1.6	1.7	1.6	1.7	V
∞V_F	Temperature coefficient of forward voltage	$I_F = 16 \text{ mA}$		-1.8		-1.8		mV/°C
V_{BR} ‡	Input breakdown voltage	$I_R = 10 \mu\text{A}$, $T_A = 25^\circ\text{C}$		5		5		V
V_{OL}	Low-level output voltage	$V_{CC} = 4.5 \text{ V}$, $I_F = 16 \text{ mA}$, $I_B = 0$	$I_{OL} = 1.1 \text{ mA}$	0.1		0.4		V
			$I_{OL} = 2.4 \text{ mA}$			0.1		
I_{OH} ‡	High-level output current	$I_F = 0$, $I_B = 0$, $T_A = 25^\circ\text{C}$	$V_{CC} = V_O = 5.5 \text{ V}$	3		500		nA
			$V_{CC} = V_O = 15 \text{ V}$	0.01		1		μA
I_{OH}	High-level output current	$V_{CC} = 15 \text{ V}$, $I_F = 0$	$V_O = 15 \text{ V}$, $I_B = 0$	50		50		μA
I_{CCH} ‡	Supply current, high-level output	$V_{CC} = 15 \text{ V}$, $I_F = 0$, $T_A = 25^\circ\text{C}$	$I_O = 0$, $I_B = 0$	0.02		1		μA
I_{CCH}	Supply current, high-level output	$V_{CC} = 15 \text{ V}$, $I_F = 0$	$I_O = 0$, $I_B = 0$	2		2		μA
I_{CCL}	Supply current, low-level output	$V_{CC} = 15 \text{ V}$, $I_F = 16 \text{ mA}$	$I_O = 0$, $I_B = 0$	40		40		μA
h_{FE}	Transistor forward current transfer ratio	$V_O = 5 \text{ V}$	$I_O = 3 \text{ mA}$	100		100 (6N136 only)		
CTR ‡	Current transfer ratio	$V_{CC} = 4.5 \text{ V}$, $I_F = 16 \text{ mA}$, $T_A = 25^\circ\text{C}$	$V_O = 0.4 \text{ V}$, $I_B = 0$, See Note 5	7%	18%	19%	24%	
CTR	Current transfer ratio	$V_{CC} = 4.5 \text{ V}$, $I_F = 16 \text{ mA}$, See Note 5	$V_O = 0.5 \text{ V}$, $I_B = 0$	5%		15%		
r_{IO}	Input-output resistance	$V_{IO} = 500 \text{ V}$, See Note 6	$T_A = 25^\circ\text{C}$	10^{12}		10^{12}		Ω
I_{IO} ‡	Input-output insulation leakage current	$V_{IO} = 3000 \text{ V}$, $T_A = 25^\circ\text{C}$, See Note 6	$t = 5 \text{ s}$, $RH = 45\%$	1		1		μA
C_i	Input capacitance	$V_F = 0$	$f = 1 \text{ MHz}$	60		60		pF
C_{io}	Input-output capacitance	$f = 1 \text{ MHz}$	See Note 6	0.6		0.6		pF

† All typical values are at $T_A = 25^\circ\text{C}$.

‡ JEDEC registered data for 6N135 and 6N136

NOTES: 5. Current transfer ratio is defined as the ratio of output collector current I_O to the forward LED input current I_F times 100%.
6. These parameters are measured with terminals 2 and 3 shorted together and terminals 5, 6, 7, and 8 shorted together.

6N135, 6N136, HCPL4502 OPTOCOUPLEDERS/OPTOISOLATORS

SOES022A – JULY 1986 – REVISED APRIL 1998

operating characteristics, $V_{CC} = 5\text{ V}$, $I_F = 16\text{ mA}$, $T_A = 25^\circ\text{C}$ (unless otherwise noted)

PARAMETER		TEST CONDITIONS	6N135			6N136, HCPL4502			UNIT
			MIN	TYP	MAX	MIN	TYP	MAX	
BW	Bandwidth (–3 dB)	$R_L = 100\ \Omega$, See Note 7	2			2			MHz

NOTE 7: Bandwidth is the range of frequencies within which the ac output voltage is not more than 3 dB below the low-frequency value.

switching characteristics at $V_{CC} = 5\text{ V}$, $I_F = 16\text{ mA}$, $T_A = 25^\circ\text{C}$

PARAMETER		TEST CONDITIONS	6N135			6N136, HCPL4502			UNIT
			MIN	TYP	MAX	MIN	TYP	MAX	
t_{PLH}^\dagger	Propagation delay time, low-to-high-level output	$R_L = 4.1\text{ k}\Omega$, See Figure 1	1 1.5						μs
		$R_L = 1.9\text{ k}\Omega$, See Figure 1				0.6 0.8			
t_{PHL}^\dagger	Propagation delay time, high-to-low-level output	$R_L = 4.1\text{ k}\Omega$, See Figure 1	0.7 1.5						μs
		$R_L = 1.9\text{ k}\Omega$, See Figure 1				0.6 0.8			
$\frac{dV_{CM}}{dt}$ (H)	Common-mode input transient immunity, high-level output	$\Delta V_{CM} = 10\text{ V}$, $R_L = 4.1\text{ k}\Omega$, See Figure 2	1000						$\text{V}/\mu\text{s}$
		$\Delta V_{CM} = 10\text{ V}$, $R_L = 1.9\text{ k}\Omega$, See Figure 2				1000			
$\frac{dV_{CM}}{dt}$ (L)	Common-mode input transient immunity, low-level output	$\Delta V_{CM} = 10\text{ V}$, See Notes 9 and 10, $R_L = 4.1\text{ k}\Omega$, See Figure 2	1000						$\text{V}/\mu\text{s}$
		$\Delta V_{CM} = 10\text{ V}$, See Notes 9 and 10, $R_L = 1.9\text{ k}\Omega$, See Figure 2				1000			

† JEDEC registered data for 6N135 and 6N136

NOTES: 8. The 4.1-k Ω load represents one LSTTL unit load of 0.36 mA and a 6.1-k Ω pullup resistor.

9. The 1.9-k Ω load represents one TTL unit load of 1.6 mA and a 5.6-k Ω pullup resistor.

10. Common-mode transient immunity, high-level output, is the maximum rate of rise of the common-mode input voltage that does not cause the output voltage to drop below 2 V. Common-mode input transient immunity, low-level output, is the maximum rate of fall of the common-mode input voltage that does not cause the output voltage to rise above 0.8 V.

PARAMETER MEASUREMENT INFORMATION

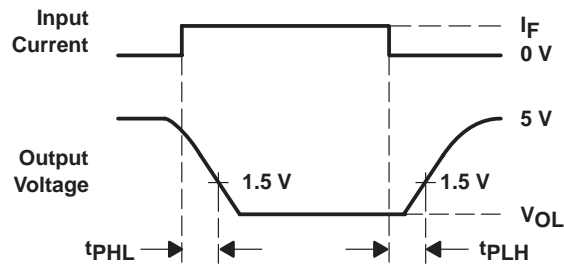
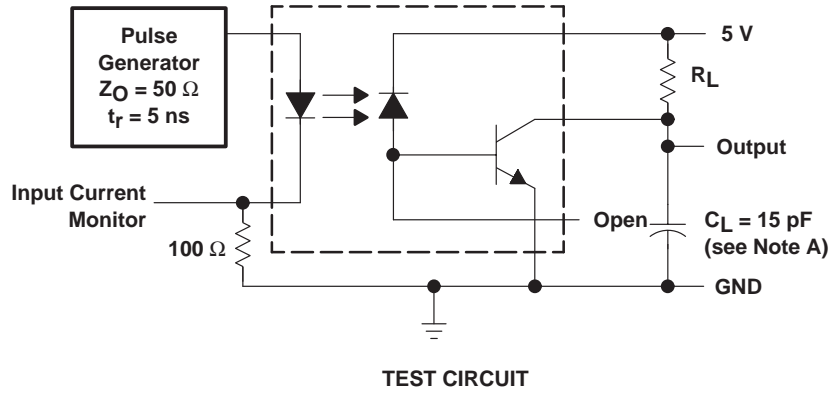

NOTE A: C_L includes probe and stray capacitance.

Figure 1. Switching Test Circuit and Waveforms

6N135, 6N136, HCPL4502 OPTOCOUPPLERS/OPTOISOLATORS

SOES022A – JULY 1986 – REVISED APRIL 1998

PARAMETER MEASUREMENT INFORMATION

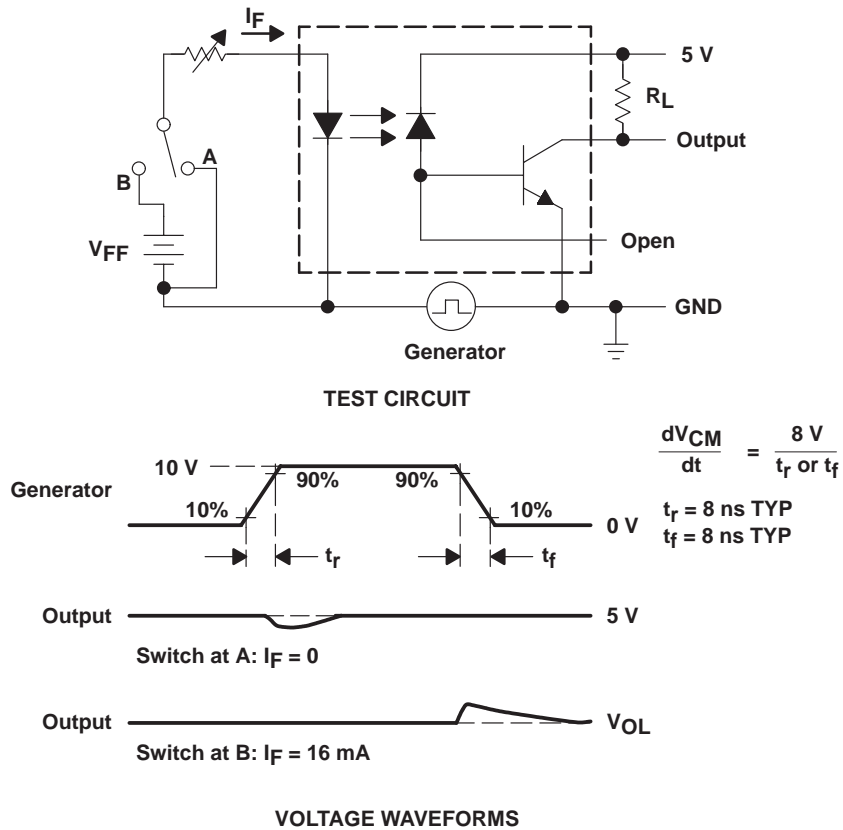
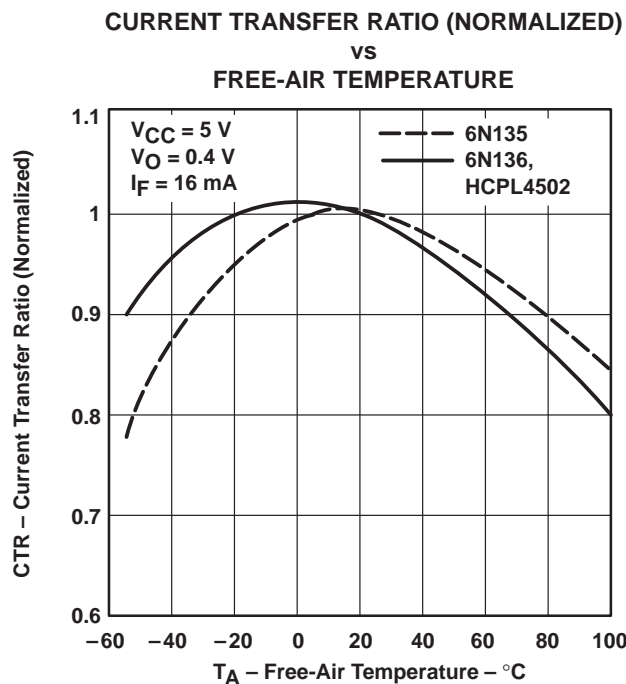
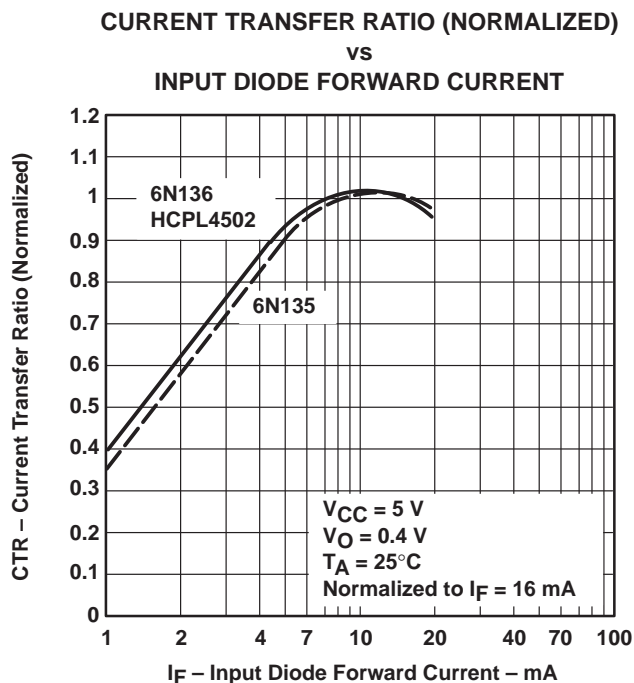
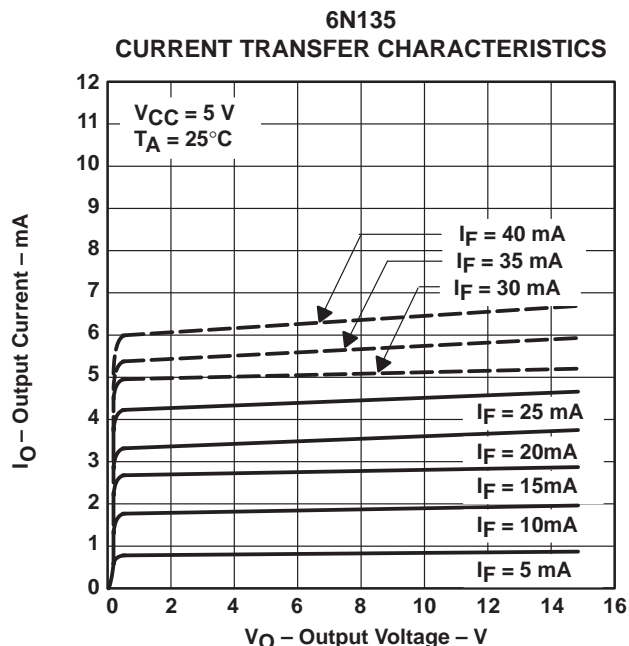
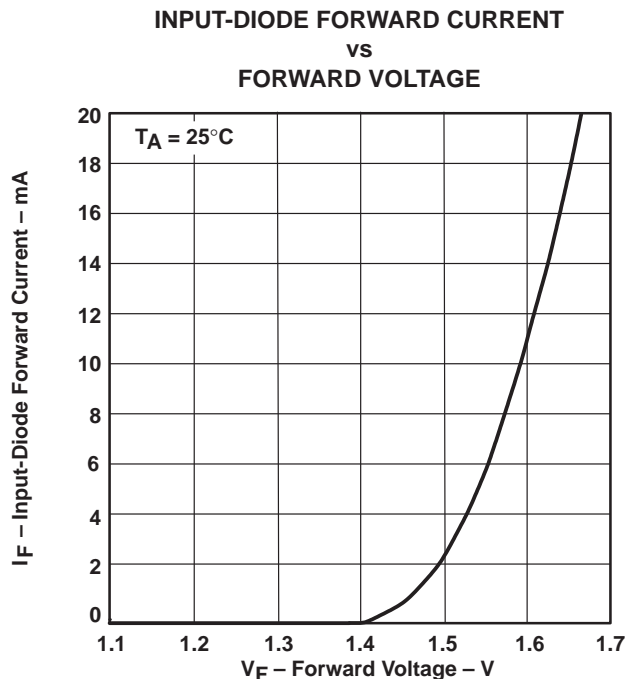

Figure 2. Transient Immunity Test Circuit and Waveforms

TYPICAL CHARACTERISTICS



6N135, 6N136, HCPL4502 OPTOCOUPLEDERS/OPTOISOLATORS

SOES022A – JULY 1986 – REVISED APRIL 1998

TYPICAL CHARACTERISTICS

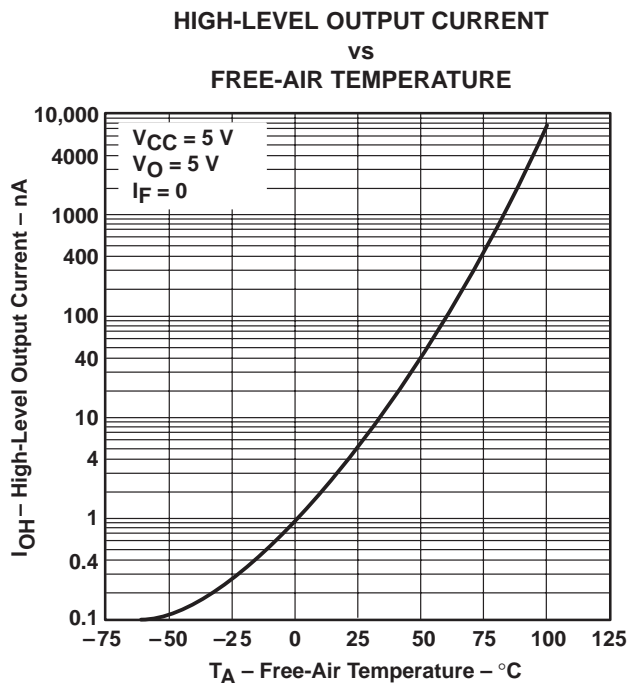

Figure 7

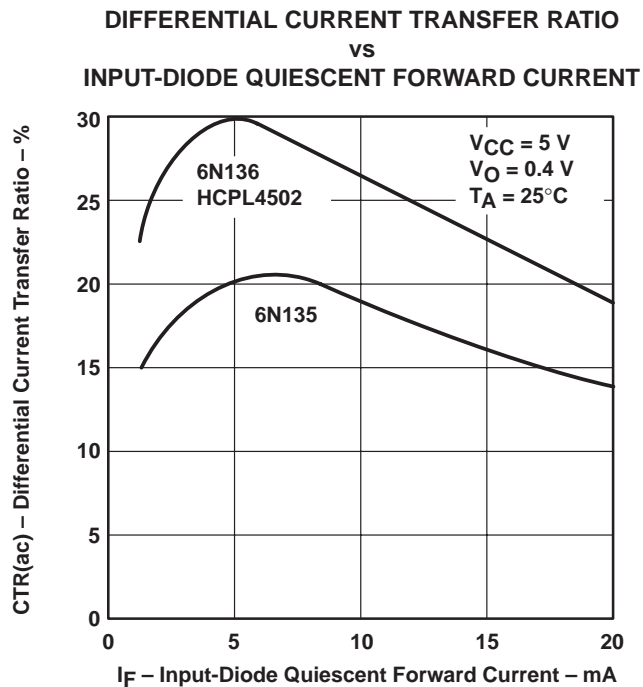

Figure 8

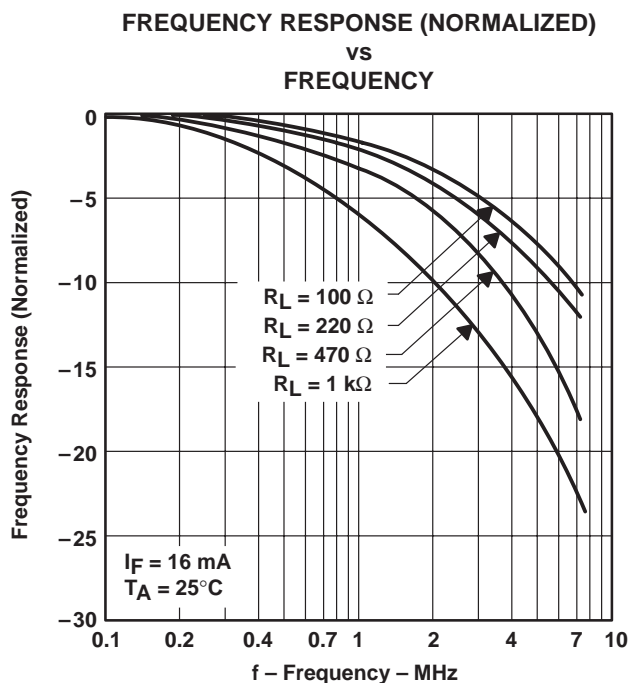

Figure 9

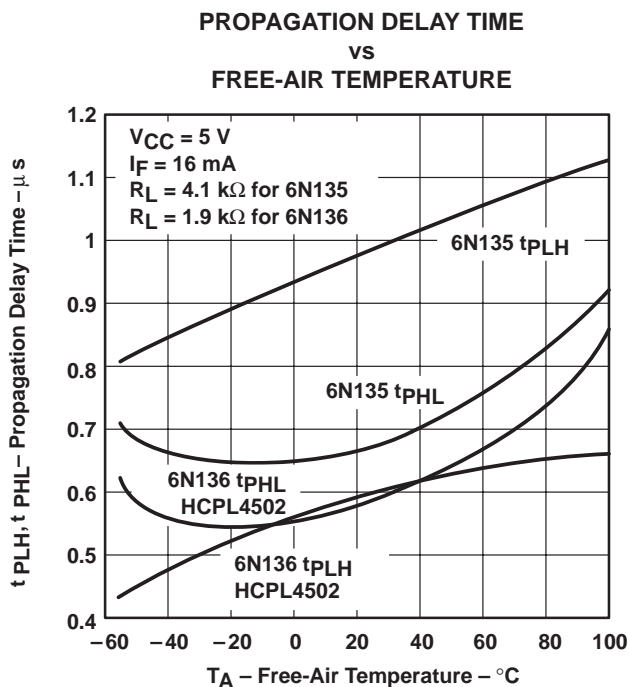
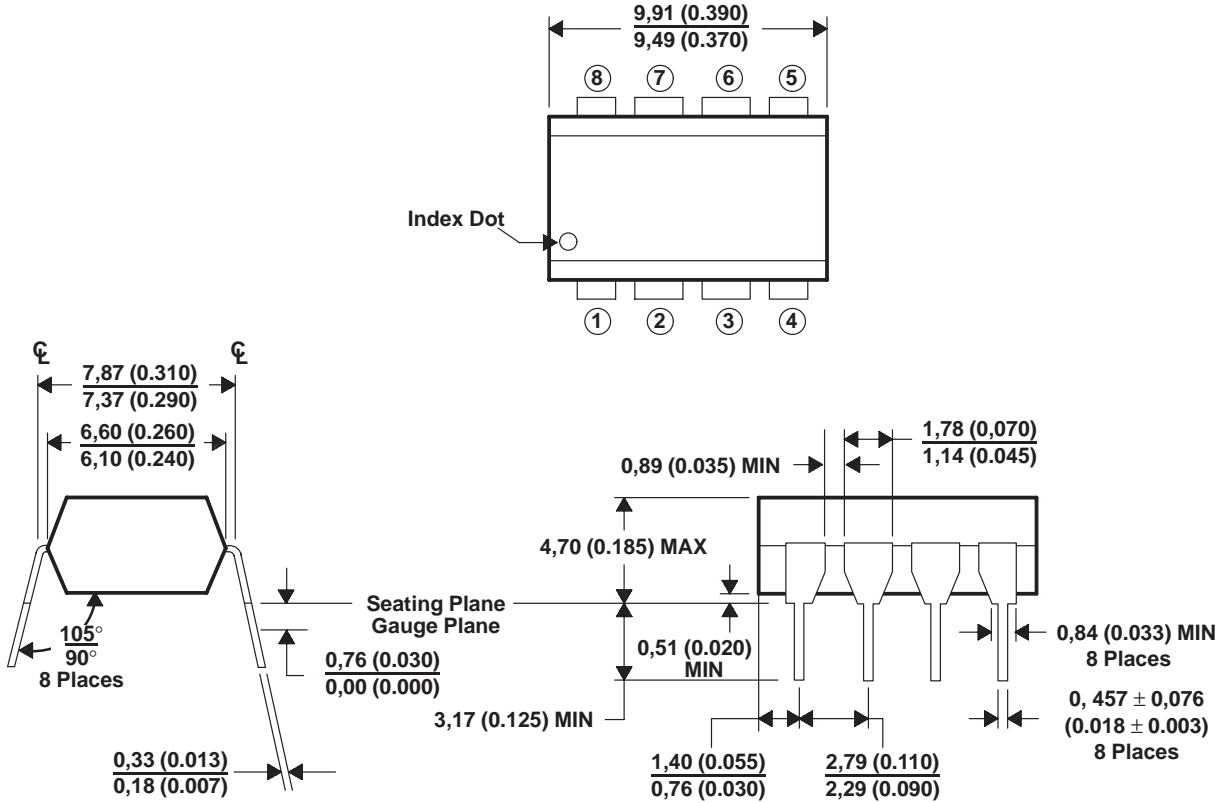

Figure 10

6N135, 6N136, HCPL4502
OPTOCOUPLEDERS/OPTOISOLATORS

SOES022A – JULY 1986 – REVISED APRIL 1998

MECHANICAL INFORMATION



NOTES: A. JEDEC registered data. This data sheet contains all applicable registered data in effect at the time of publication.
B. All linear dimensions are given in millimeters and parenthetically given in inches.

Figure 11. Packaging Specifications

IMPORTANT NOTICE

Texas Instruments and its subsidiaries (TI) reserve the right to make changes to their products or to discontinue any product or service without notice, and advise customers to obtain the latest version of relevant information to verify, before placing orders, that information being relied on is current and complete. All products are sold subject to the terms and conditions of sale supplied at the time of order acknowledgement, including those pertaining to warranty, patent infringement, and limitation of liability.

TI warrants performance of its semiconductor products to the specifications applicable at the time of sale in accordance with TI's standard warranty. Testing and other quality control techniques are utilized to the extent TI deems necessary to support this warranty. Specific testing of all parameters of each device is not necessarily performed, except those mandated by government requirements.

CERTAIN APPLICATIONS USING SEMICONDUCTOR PRODUCTS MAY INVOLVE POTENTIAL RISKS OF DEATH, PERSONAL INJURY, OR SEVERE PROPERTY OR ENVIRONMENTAL DAMAGE ("CRITICAL APPLICATIONS"). TI SEMICONDUCTOR PRODUCTS ARE NOT DESIGNED, AUTHORIZED, OR WARRANTED TO BE SUITABLE FOR USE IN LIFE-SUPPORT DEVICES OR SYSTEMS OR OTHER CRITICAL APPLICATIONS. INCLUSION OF TI PRODUCTS IN SUCH APPLICATIONS IS UNDERSTOOD TO BE FULLY AT THE CUSTOMER'S RISK.

In order to minimize risks associated with the customer's applications, adequate design and operating safeguards must be provided by the customer to minimize inherent or procedural hazards.

TI assumes no liability for applications assistance or customer product design. TI does not warrant or represent that any license, either express or implied, is granted under any patent right, copyright, mask work right, or other intellectual property right of TI covering or relating to any combination, machine, or process in which such semiconductor products or services might be or are used. TI's publication of information regarding any third party's products or services does not constitute TI's approval, warranty or endorsement thereof.