

**FAIRCHILD**  
SEMICONDUCTOR™

November 1988  
Revised November 1999

## 74AC00 • 74ACT00 Quad 2-Input NAND Gate

### General Description

The AC/ACT00 contains four 2-input NAND gates.

### Features

- I<sub>CC</sub> reduced by 50%
- Outputs source/sink 24 mA
- ACT00 has TTL-compatible inputs

### Ordering Code:

Order Number	Package Number	Package Description
74AC00SC	M14A	14-Lead Small Outline Integrated Circuit (SOIC), JEDEC MS-120, 0.150" Narrow Body
74AC00SJ	M14D	14-Lead Small Outline Package (SOP), EIAJ Type II, 5.3mm Wide
74AC00MTC	MTC14	14-Lead Thin Shrink Small Outline Package (TSSOP), JEDEC MO-153, 4.4mm Wide
74AC00PC	N14A	14-Lead Plastic Dual-In-Line Package (PDIP), JEDEC MS-001, 0.300" Wide
74ACT00SC	M14A	14-Lead Small Outline Integrated Circuit (SOIC), JEDEC MS-120, 0.150" Narrow Body
74ACT00SJ	M14D	14-Lead Small Outline Package (SOP), EIAJ Type II, 5.3mm Wide
74ACT00MTC	MTC14	14-Lead Thin Shrink Small Outline Package (TSSOP), JEDEC MO-153, 4.4mm Wide
74ACT00PC	N14A	14-Lead Plastic Dual-In-Line Package (PDIP), JEDEC MS-001, 0.300" Wide

Device also available in Tape and Reel. Specify by appending suffix letter "X" to the ordering form. (PC not available in Tape and Reel.)

### Logic Symbol

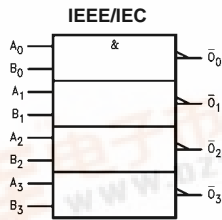

### Connection Diagram

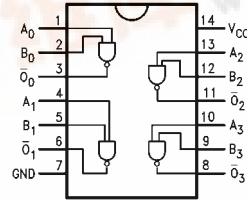

### Pin Descriptions

Pin Names	Description
A <sub>n</sub> , B <sub>n</sub>	Inputs
$\bar{O}_n$	Outputs

FACT™ is a trademark of Fairchild Semiconductor Corporation.



**Absolute Maximum Ratings**(Note 1)

Supply Voltage ( $V_{CC}$ )	-0.5V to +7.0V
DC Input Diode Current ( $I_{IK}$ )	
$V_I = -0.5V$	-20 mA
$V_I = V_{CC} + 0.5V$	+20 mA
DC Input Voltage ( $V_I$ )	-0.5V to $V_{CC} + 0.5V$
DC Output Diode Current ( $I_{OK}$ )	
$V_O = -0.5V$	-20 mA
$V_O = V_{CC} + 0.5V$	+20 mA
DC Output Voltage ( $V_O$ )	-0.5V to $V_{CC} + 0.5V$
DC Output Source	
or Sink Current ( $I_O$ )	$\pm 50$ mA
DC $V_{CC}$ or Ground Current	
per Output Pin ( $I_{CC}$ or $I_{GND}$ )	$\pm 50$ mA
Storage Temperature ( $T_{STG}$ )	-65°C to +150°C
Junction Temperature ( $T_J$ )	
PDIP	140°C

**Recommended Operating Conditions**

Supply Voltage ( $V_{CC}$ )	
AC	2.0V to 6.0V
ACT	4.5V to 5.5V
Input Voltage ( $V_I$ )	0V to $V_{CC}$
Output Voltage ( $V_O$ )	0V to $V_{CC}$
Operating Temperature ( $T_A$ )	-40°C to +85°C
Minimum Input Edge Rate ( $\Delta V/\Delta t$ )	
AC Devices	
$V_{IN}$ from 30% to 70% of $V_{CC}$	
$V_{CC}$ @ 3.3V, 4.5V, 5.5V	125 mV/ns
Minimum Input Edge Rate ( $\Delta V/\Delta t$ )	
ACT Devices	
$V_{IN}$ from 0.8V to 2.0V	
$V_{CC}$ @ 4.5V, 5.5V	125 mV/ns

**Note 1:** Absolute maximum ratings are those values beyond which damage to the device may occur. The databook specifications should be met, without exception, to ensure that the system design is reliable over its power supply, temperature, and output/input loading variables. Fairchild does not recommend operation of FACT™ circuits outside databook specifications.

**DC Electrical Characteristics for AC**

Symbol	Parameter	$V_{CC}$ (V)	$T_A = +25^\circ\text{C}$		$T_A = -40^\circ\text{C to } +85^\circ\text{C}$		Units	Conditions
			Typ	Guaranteed Limits				
$V_{IH}$	Minimum HIGH Level Input Voltage	3.0	1.5	2.1	2.1	V	$V_{OUT} = 0.1V$ or $V_{CC} - 0.1V$	
		4.5	2.25	3.15	3.15			
		5.5	2.75	3.85	3.85			
$V_{IL}$	Maximum LOW Level Input Voltage	3.0	1.5	0.9	0.9	V	$V_{OUT} = 0.1V$ or $V_{CC} - 0.1V$	
		4.5	2.25	1.35	1.35			
		5.5	2.75	1.65	1.65			
$V_{OH}$	Minimum HIGH Level Output Voltage	3.0	2.99	2.9	2.9	V	$I_{OUT} = -50 \mu A$	
		4.5	4.49	4.4	4.4			
		5.5	5.49	5.4	5.4			
		3.0		2.56	2.46	V	$V_{IN} = V_{IL}$ or $V_{IH}$ $I_{OH} = -12$ mA $I_{OH} = -24$ mA $I_{OH} = -24$ mA (Note 2)	
		4.5		3.86	3.76			
		5.5		4.86	4.76			
$V_{OL}$	Maximum LOW Level Output Voltage	3.0	0.002	0.1	0.1	V	$I_{OUT} = 50 \mu A$	
		4.5	0.001	0.1	0.1			
		5.5	0.001	0.1	0.1			
		3.0		0.36	0.44	V	$V_{IN} = V_{IL}$ or $V_{IH}$ $I_{OL} = 12$ mA $I_{OL} = 24$ mA $I_{OL} = 24$ mA (Note 2)	
		4.5		0.36	0.44			
		5.5		0.36	0.44			
$I_{IN}$ (Note 3)	Maximum Input Leakage Current	5.5		$\pm 0.1$	$\pm 1.0$	$\mu A$	$V_I = V_{CC}, GND$	
$I_{OLD}$	Minimum Dynamic	5.5			75	mA	$V_{OLD} = 1.65V$ Max	
$I_{OHD}$	Output Current (Note 4)	5.5			-75	mA	$V_{OHD} = 3.85V$ Min	
$I_{CC}$ (Note 3)	Maximum Quiescent Supply Current	5.5		2.0	20.0	$\mu A$	$V_{IN} = V_{CC}$ or GND	

**Note 2:** All outputs loaded; thresholds on input associated with output under test.

**Note 3:**  $I_{IN}$  and  $I_{CC}$  @ 3.0V are guaranteed to be less than or equal to the respective limit @ 5.5V  $V_{CC}$ .

**Note 4:** Maximum test duration 2.0 ms, one output loaded at a time.

### DC Electrical Characteristics for ACT

Symbol	Parameter	V <sub>CC</sub>	T <sub>A</sub> = +25°C		T <sub>A</sub> = -40°C to +85°C		Units	Conditions
		(V)	Typ	Guaranteed Limits				
V <sub>IH</sub>	Minimum HIGH Level Input Voltage	4.5	1.5	2.0	2.0	V	V <sub>OUT</sub> = 0.1V or V <sub>CC</sub> - 0.1V	
		5.5	1.5	2.0	2.0			
V <sub>IL</sub>	Maximum LOW Level Input Voltage	4.5	1.5	0.8	0.8	V	V <sub>OUT</sub> = 0.1V or V <sub>CC</sub> - 0.1V	
		5.5	1.5	0.8	0.8			
V <sub>OH</sub>	Minimum HIGH Level Output Voltage	4.5	4.49	4.4	4.4	V	I <sub>OUT</sub> = -50 μA	
		5.5	5.49	5.4	5.4			
		4.5		3.86	3.76	V	V <sub>IN</sub> = V <sub>IL</sub> or V <sub>IH</sub> I <sub>OH</sub> = -24 mA I <sub>OH</sub> = -24 mA (Note 5)	
		5.5		4.86	4.76			
V <sub>OL</sub>	Maximum LOW Level Output Voltage	4.5	0.001	0.1	0.1	V	I <sub>OUT</sub> = 50 μA	
		5.5	0.001	0.1	0.1			
		4.5		0.36	0.44	V	V <sub>IN</sub> = V <sub>IL</sub> or V <sub>IH</sub> I <sub>OL</sub> = 24 mA I <sub>OL</sub> = 24 mA (Note 5)	
		5.5		0.36	0.44			
I <sub>IN</sub>	Maximum Input Leakage Current	5.5		±0.1	±1.0	μA	V <sub>I</sub> = V <sub>CC</sub> , GND	
I <sub>CCT</sub>	Maximum I <sub>CC</sub> /Input	5.5	0.6		1.5	mA	V <sub>I</sub> = V <sub>CC</sub> - 2.1V	
I <sub>OLD</sub>	Minimum Dynamic	5.5			75	mA	V <sub>OLD</sub> = 1.65V Max	
I <sub>OHD</sub>	Output Current (Note 6)	5.5			-75	mA	V <sub>OHD</sub> = 3.85V Min	
I <sub>CC</sub>	Maximum Quiescent Supply Current	5.5		2.0	20.0	μA	V <sub>IN</sub> = V <sub>CC</sub> or GND	

**Note 5:** All outputs loaded; thresholds on input associated with output under test.

**Note 6:** Maximum test duration 2.0 ms, one output loaded at a time.

### AC Electrical Characteristics for AC

Symbol	Parameter	V <sub>CC</sub> (V) (Note 7)	T <sub>A</sub> = +25°C C <sub>L</sub> = 50 pF			T <sub>A</sub> = -40°C to +85°C C <sub>L</sub> = 50 pF		Units
			Min	Typ	Max	Min	Max	
t <sub>PLH</sub>	Propagation Delay	3.3	2.0	7.0	9.5	2.0	10.0	ns
		5.0	1.5	6.0	8.0	1.5	8.5	
t <sub>PHL</sub>	Propagation Delay	3.3	1.5	5.5	8.0	1.0	8.5	ns
		5.0	1.5	4.5	6.5	1.0	7.0	

**Note 7:** Voltage Range 3.3 is 3.3V ± 0.3V

Voltage Range 5.0 is 5.0V ± 0.5V

### AC Electrical Characteristics for ACT

Symbol	Parameter	V <sub>CC</sub> (V) (Note 8)	T <sub>A</sub> = +25°C C <sub>L</sub> = 50 pF			T <sub>A</sub> = -40°C to +85°C C <sub>L</sub> = 50 pF		Units
			Min	Typ	Max	Min	Max	
t <sub>PLH</sub>	Propagation Delay	5.0	1.5	5.5	9.0	1.0	9.5	ns
t <sub>PHL</sub>	Propagation Delay	5.0	1.5	4.0	7.0	1.0	8.0	ns

**Note 8:** Voltage Range 5.0 is 5.0V ± 0.5V

### Capacitance

Symbol	Parameter	Typ	Units	Conditions
C <sub>IN</sub>	Input Capacitance	4.5	pF	V <sub>CC</sub> = Open
C <sub>PD</sub>	Power Dissipation Capacitance	30.0	pF	V <sub>CC</sub> = 5.0V

**Physical Dimensions** inches (millimeters) unless otherwise noted

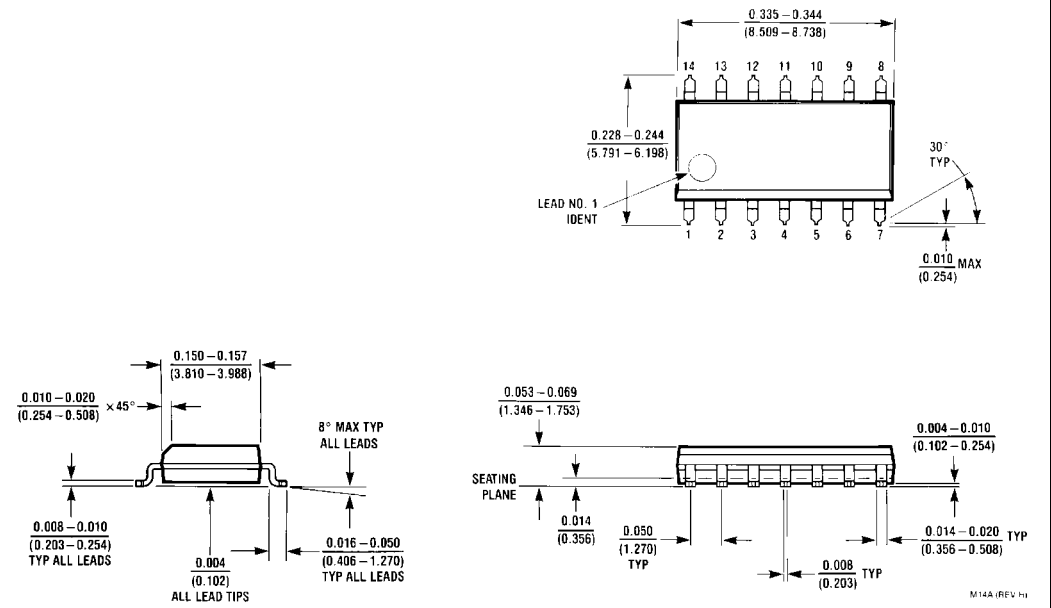

14-Lead Small Outline Integrated Circuit (SOIC), JEDEC MS-120, 0.150" Narrow Body  
Package Number M14A

**Physical Dimensions** inches (millimeters) unless otherwise noted (Continued)

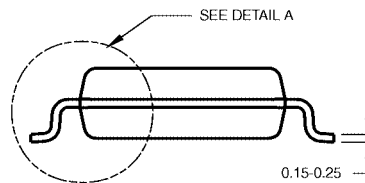
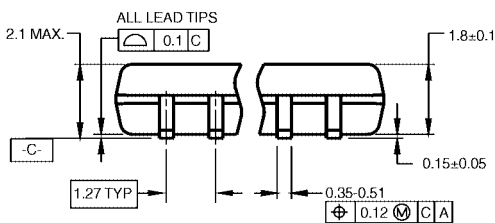
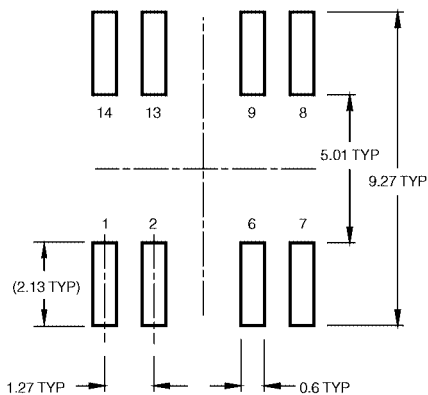
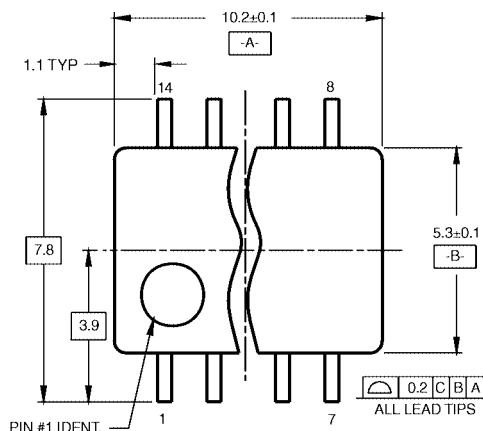

DIMENSIONS ARE IN MILLIMETERS

- NOTES:  
 A. CONFORMS TO EIAJ EDR-7320 REGISTRATION, ESTABLISHED IN DECEMBER, 1998.  
 B. DIMENSIONS ARE IN MILLIMETERS.  
 C. DIMENSIONS ARE EXCLUSIVE OF BURRS, MOLD FLASH, AND TIE BAR EXTRUSIONS.

M14DRevB1

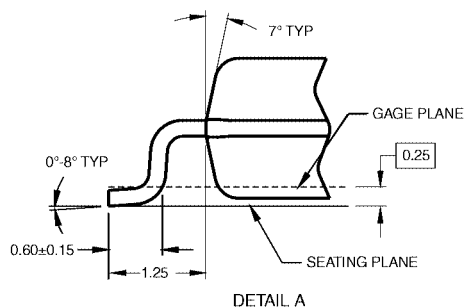

**14-Lead Small Outline Package (SOIC), EIAJ Type II, 5.3mm Wide  
 Package Number M14D**

**Physical Dimensions** inches (millimeters) unless otherwise noted (Continued)

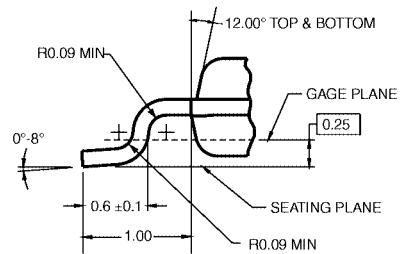
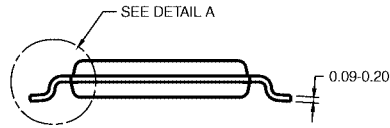
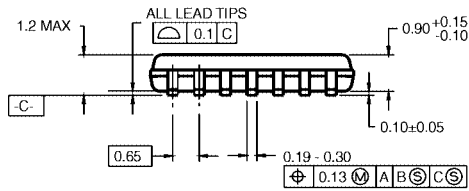
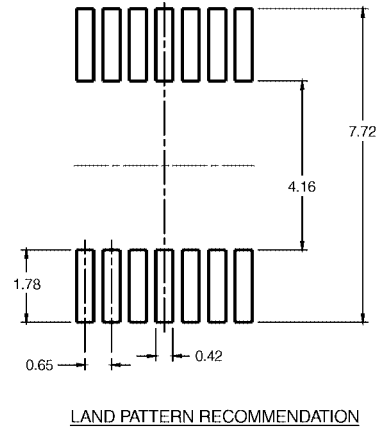
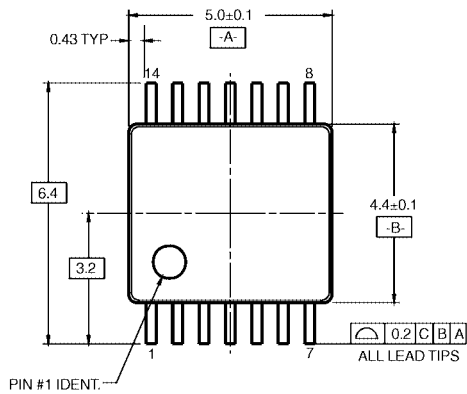

- NOTES:
- A. CONFORMS TO JEDEC REGISTRATION MO-153, VARIATION AB, REF NOTE 6, DATE 7/93.
  - B. DIMENSIONS ARE IN MILLIMETERS.
  - C. DIMENSIONS ARE EXCLUSIVE OF BURRS, MOLD FLASH, AND TIE BAR EXTRUSIONS.
  - D. DIMENSIONS AND TOLERANCES PER ANSI Y14.5M, 1982.

MTC14RevC3

DETAIL A

**14-Lead Thin Shrink Small Outline Package (TSSOP), JEDEC MO-153, 4.4mm Wide  
Package Number MTC14**

**Physical Dimensions** inches (millimeters) unless otherwise noted (Continued)

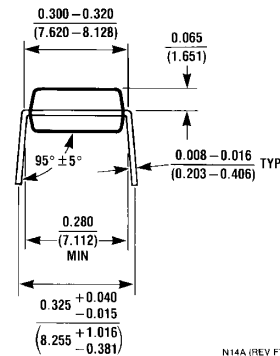
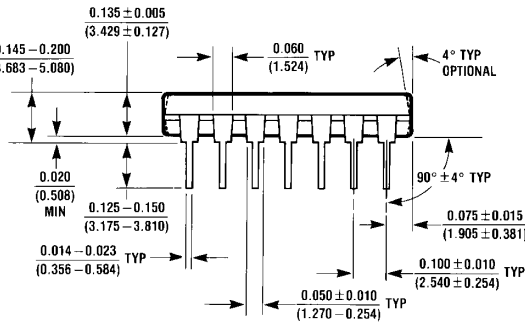
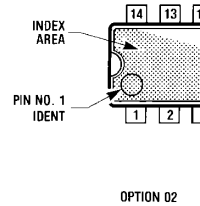
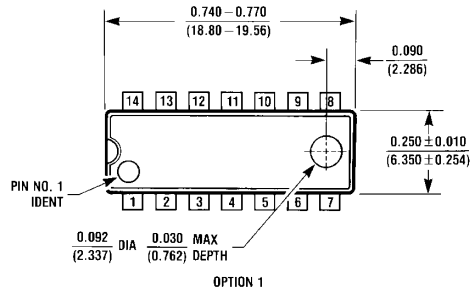

N14A (REV F)

**14-Lead Plastic Dual-In-Line Package (PDIP), JEDEC MS-001, 0.300" Wide Package Number N14A**

Fairchild does not assume any responsibility for use of any circuitry described, no circuit patent licenses are implied and Fairchild reserves the right at any time without notice to change said circuitry and specifications.

**LIFE SUPPORT POLICY**

FAIRCHILD'S PRODUCTS ARE NOT AUTHORIZED FOR USE AS CRITICAL COMPONENTS IN LIFE SUPPORT DEVICES OR SYSTEMS WITHOUT THE EXPRESS WRITTEN APPROVAL OF THE PRESIDENT OF FAIRCHILD SEMICONDUCTOR CORPORATION. As used herein:

1. Life support devices or systems are devices or systems which, (a) are intended for surgical implant into the body, or (b) support or sustain life, and (c) whose failure to perform when properly used in accordance with instructions for use provided in the labeling, can be reasonably expected to result in a significant injury to the user.
2. A critical component in any component of a life support device or system whose failure to perform can be reasonably expected to cause the failure of the life support device or system, or to affect its safety or effectiveness.

[www.fairchildsemi.com](http://www.fairchildsemi.com)