

**FAIRCHILD**  
SEMICONDUCTOR™

April 1988  
Revised September 2000

## 74F240 • 74F241 • 74F244

### Octal Buffers/Line Drivers with 3-STATE Outputs

#### General Description

The 74F240, 74F241 and 74F244 are octal buffers and line drivers designed to be employed as memory and address drivers, clock drivers and bus-oriented transmitters/receivers which provide improved PC and board density.

#### Features

- 3-STATE outputs drive bus lines or buffer memory address registers
- Outputs sink 64 mA (48 mA mil)
- 12 mA source current
- Input clamp diodes limit high-speed termination effects

#### Ordering Code:

Order Code	Package Number	Package Description
74F240SC	M20B	20-Lead Small Outline Integrated Circuit (SOIC), JEDEC MS-013, 0.300 Wide
74F240SJ	M20D	20-Lead Small Outline Package (SOP), EIAJ TYPE II, 5.3mm Wide
74F240PC	N20A	20-Lead Plastic Dual-In-Line Package (PDIP), JEDEC MS-001, 0.300 Wide
74F241SC	M20B	20-Lead Small Outline Integrated Circuit (SOIC), JEDEC MS-013, 0.300 Wide
74F241SJ	M20D	20-Lead Small Outline Package (SOP), EIAJ TYPE II, 5.3mm Wide
74F241PC	N20A	20-Lead Plastic Dual-In-Line Package (PDIP), JEDEC MS-001, 0.300 Wide
74F244SC	M20B	20-Lead Small Outline Integrated Circuit (SOIC), JEDEC MS-013, 0.300 Wide
74F244SJ	M20D	20-Lead Small Outline Package (SOP), EIAJ TYPE II, 5.3mm Wide
74F244MSA	MSA20	20-Lead Shrink Small Outline Package (SSOP), EIAJ TYPE II, 5.3mm Wide
74F244PC	N20A	20-Lead Plastic Dual-In-Line Package (PDIP), JEDEC MS-001, 0.300 Wide

Devices also available in Tape and Reel. Specify by appending the suffix letter "X" to the ordering code.

#### Connection Diagrams

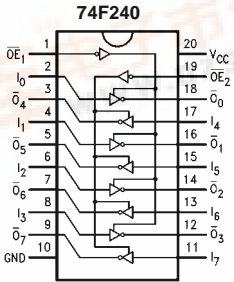

74F240

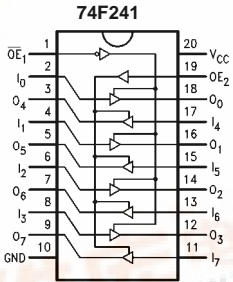

74F241

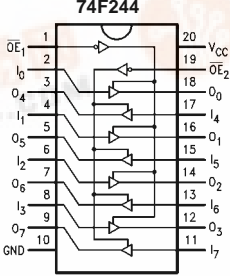

74F244

74F240 • 74F241 • 74F244 Octal Buffers/Line Drivers with 3-STATE Outputs



## Logic Symbols

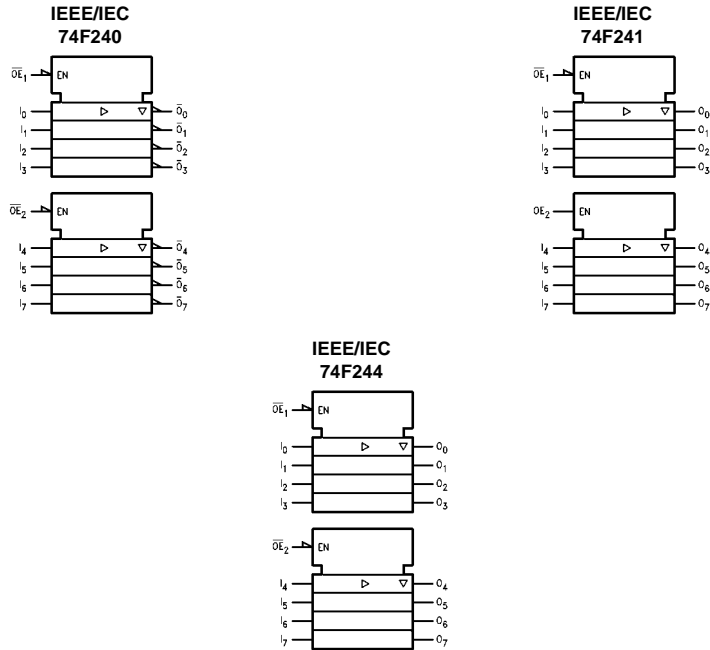

## Unit Loading/Fan Out

Pin Names	Description	U.L. HIGH/LOW	Input $I_{IH}/I_{IL}$ Output $I_{OH}/I_{OL}$
$\overline{OE}_1, \overline{OE}_2$	3-STATE Output Enable Input (Active LOW)	1.0/1.667	20 $\mu$ A/-1 mA
$OE_2$	3-STATE Output Enable Input (Active HIGH)	1.0/1.667	20 $\mu$ A/-1 mA
$I_0-I_7$	Inputs (74F240)	1.0/1.667 (Note 1)	20 $\mu$ A/-1 mA
$I_0-I_7$	Inputs (74F241, 74F244)	1.0/2.667 (Note 1)	20 $\mu$ A/-1.6 mA
$\overline{O}_0-\overline{O}_7, O_0-O_7$	Outputs	600/106.6 (80)	-12 mA/64 mA (48 mA)

Note 1: Worst-case 74F240 enabled; 74F241, 74F244 disabled

## Truth Tables

74F240

$\overline{OE}_1$	$D_{1n}$	$O_{1n}$	$\overline{OE}_2$	$D_{2n}$	$O_{2n}$
H	X	Z	H	X	Z
L	H	L	L	H	L
L	L	H	L	L	H

74F244

$\overline{OE}_1$	$D_{1n}$	$O_{1n}$	$\overline{OE}_2$	$D_{2n}$	$O_{2n}$
H	X	Z	H	X	Z
L	H	H	L	H	H
L	L	L	L	L	L

74F241

$\overline{OE}_1$	$D_{1n}$	$O_{1n}$	$OE_2$	$D_{2n}$	$O_{2n}$
H	X	Z	L	X	Z
L	H	H	H	H	H
L	L	L	H	L	L

H = HIGH Voltage Level  
 L = LOW Voltage Level  
 X = Immaterial  
 Z = High Impedance

**Absolute Maximum Ratings**(Note 2)

Storage Temperature	-65°C to +150°C
Ambient Temperature under Bias	-55°C to +125°C
Junction Temperature under Bias	-55°C to +150°C
V <sub>CC</sub> Pin Potential to Ground Pin	-0.5V to +7.0V
Input Voltage (Note 3)	-0.5V to +7.0V
Input Current (Note 3)	-30 mA to +5.0 mA
Voltage Applied to Output in HIGH State (with V <sub>CC</sub> = 0V)	
Standard Output	-0.5V to V <sub>CC</sub>
3-STATE Output	-0.5V to +5.5V
Current Applied to Output in LOW State (Max)	twice the rated I <sub>OL</sub> (mA)
ESD Last Passing Voltage (Min)	4000V

**Recommended Operating Conditions**

Free Air Ambient Temperature	0°C to +70°C
Supply Voltage	+4.5V to +5.5V

**Note 2:** Absolute maximum ratings are values beyond which the device may be damaged or have its useful life impaired. Functional operation under these conditions is not implied.

**Note 3:** Either voltage limit or current limit is sufficient to protect inputs.

**DC Electrical Characteristics**

Symbol	Parameter	Min	Typ	Max	Units	V <sub>CC</sub>	Conditions
V <sub>IH</sub>	Input HIGH Voltage	2.0			V		Recognized as a HIGH Signal
V <sub>IL</sub>	Input LOW Voltage			0.8	V		Recognized as a LOW Signal
V <sub>CD</sub>	Input Clamp Diode Voltage			-1.2	V	Min	I <sub>IN</sub> = -18 mA
V <sub>OH</sub>	Output HIGH Voltage	10% V <sub>CC</sub>	2.4				I <sub>OH</sub> = -3 mA
		10% V <sub>CC</sub>	2.0		V	Min	I <sub>OH</sub> = -15 mA
		5% V <sub>CC</sub>	2.7				I <sub>OH</sub> = -3 mA
V <sub>OL</sub>	Output LOW Voltage	10% V <sub>CC</sub>		0.55	V	Min	I <sub>OL</sub> = 64 mA
I <sub>IH</sub>	Input HIGH Current			5.0	μA	Max	V <sub>IN</sub> = 2.7V
I <sub>BVI</sub>	Input HIGH Current Breakdown Test			7.0	μA	Max	V <sub>IN</sub> = 7.0V
I <sub>CEX</sub>	Output HIGH Leakage Current			50	μA	Max	V <sub>OUT</sub> = V <sub>CC</sub>
V <sub>ID</sub>	Input Leakage Test	4.75			V	0.0	I <sub>ID</sub> = 1.9 μA All Other Pins Grounded
I <sub>OD</sub>	Output Leakage Circuit Current			3.75	μA	0.0	V <sub>IOD</sub> = 150 mV All Other Pins Grounded
I <sub>IL</sub>	Input LOW Current			-1.0 -1.6	mA	Max	V <sub>IN</sub> = 0.5V ( $\overline{OE}_1, \overline{OE}_2, OE_2, D_n$ 74F240) V <sub>IN</sub> = 0.5V (D <sub>n</sub> (74F241, 74F244))
I <sub>OZH</sub>	Output Leakage Current			50	μA	Max	V <sub>OUT</sub> = 2.7V
I <sub>OZL</sub>	Output Leakage Current			-50	μA	Max	V <sub>OUT</sub> = 0.5V
I <sub>OS</sub>	Output Short-Circuit Current	-100		-225	mA	Max	V <sub>OUT</sub> = 0V
I <sub>ZZ</sub>	Bus Drainage Test			500	μA	0.0V	V <sub>OUT</sub> = 5.25V
I <sub>CCH</sub>	Power Supply Current (74F240)		19	29	mA	Max	V <sub>O</sub> = HIGH
I <sub>CCL</sub>	Power Supply Current (74F240)		50	75	mA	Max	V <sub>O</sub> = LOW
I <sub>CCZ</sub>	Power Supply Current (74F240)		42	63	mA	Max	V <sub>O</sub> = HIGH Z
I <sub>CCH</sub>	Power Supply Current (74F241, 74F244)		40	60	mA	Max	V <sub>O</sub> = HIGH
I <sub>CCL</sub>	Power Supply Current (74F241, 74F244)		60	90	mA	Max	V <sub>O</sub> = LOW
I <sub>CCZ</sub>	Power Supply Current (74F241, 74F244)		60	90	mA	Max	V <sub>O</sub> = HIGH Z

AC Electrical Characteristics									
Symbol	Parameter	T <sub>A</sub> = +25°C V <sub>CC</sub> = +5.0V C <sub>L</sub> = 50 pF			T <sub>A</sub> = -55°C to +125°C V <sub>CC</sub> = 5.0V C <sub>L</sub> = 50 pF		T <sub>A</sub> = 0°C to +70°C V <sub>CC</sub> = 5.0V C <sub>L</sub> = 50 pF		Units
		Min	Typ	Max	Min	Max	Min	Max	
t <sub>PLH</sub>	Propagation Delay	3.0	5.1	7.0	3.0	9.0	3.0	8.0	ns
t <sub>PHL</sub>	Data to Output (74F240)	2.0	3.5	4.7	2.0	6.0	2.0	5.7	
t <sub>PZH</sub>	Output Enable Time (74F240)	2.0	3.5	4.7	2.0	6.5	2.0	5.7	ns
t <sub>PZL</sub>		4.0	6.9	9.0	4.0	10.5	4.0	10.0	
t <sub>PHZ</sub>	Output Disable Time (74F240)	2.0	4.0	5.3	2.0	6.5	2.0	6.3	ns
t <sub>PLZ</sub>		2.0	6.0	8.0	2.0	12.5	2.0	9.5	
t <sub>PLH</sub>	Propagation Delay	2.5	4.0	5.2	2.0	6.5	2.5	6.2	ns
t <sub>PHL</sub>	Data to Output (74F241, 74F244)	2.5	4.0	5.2	2.0	7.0	2.5	6.5	
t <sub>PZH</sub>	Output Enable Time (74F241, 74F244)	2.0	4.3	5.7	2.0	7.0	2.0	6.7	ns
t <sub>PZL</sub>		2.0	5.4	7.0	2.0	8.5	2.0	8.0	
t <sub>PHZ</sub>	Output Disable Time (74F241, 74F244)	2.0	4.5	6.0	2.0	7.0	2.0	7.0	ns
t <sub>PLZ</sub>		2.0	4.5	6.0	2.0	7.5	2.0	7.0	

**Physical Dimensions** inches (millimeters) unless otherwise noted



**20-Lead Small Outline Integrated Circuit (SOIC), JEDEC MS-013, 0.300 Wide  
Package Number M20B**

M20B (REV F)

**Physical Dimensions** inches (millimeters) unless otherwise noted (Continued)

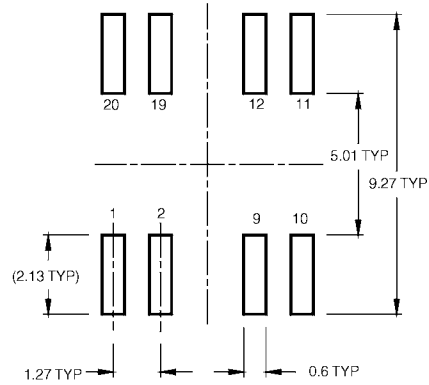
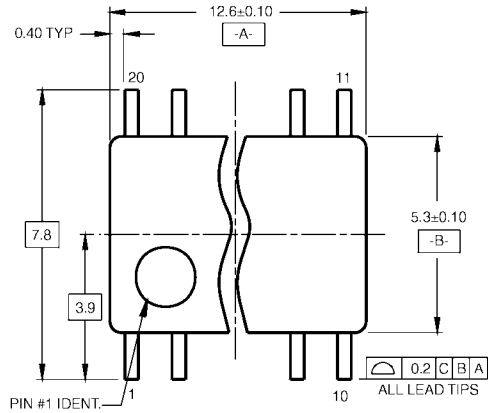

LAND PATTERN RECOMMENDATION

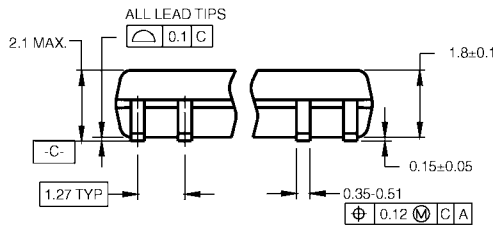

DIMENSIONS ARE IN MILLIMETERS

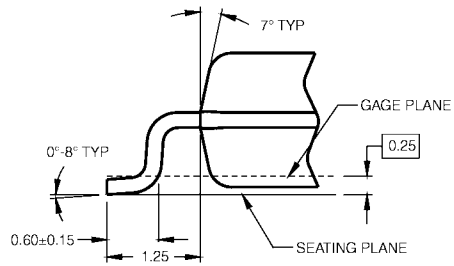
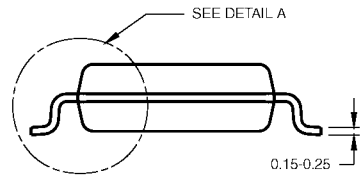

DETAIL A

- NOTES:  
 A. CONFORMS TO EIAJ EDR-7320 REGISTRATION, ESTABLISHED IN DECEMBER, 1998.  
 B. DIMENSIONS ARE IN MILLIMETERS.  
 C. DIMENSIONS ARE EXCLUSIVE OF BURRS, MOLD FLASH, AND TIE BAR EXTRUSIONS.

M20DRRevB1

**20-Lead Small Outline Package (SOP), EIAJ TYPE II, 5.3mm Wide  
 Package Number M20D**

**Physical Dimensions** inches (millimeters) unless otherwise noted (Continued)

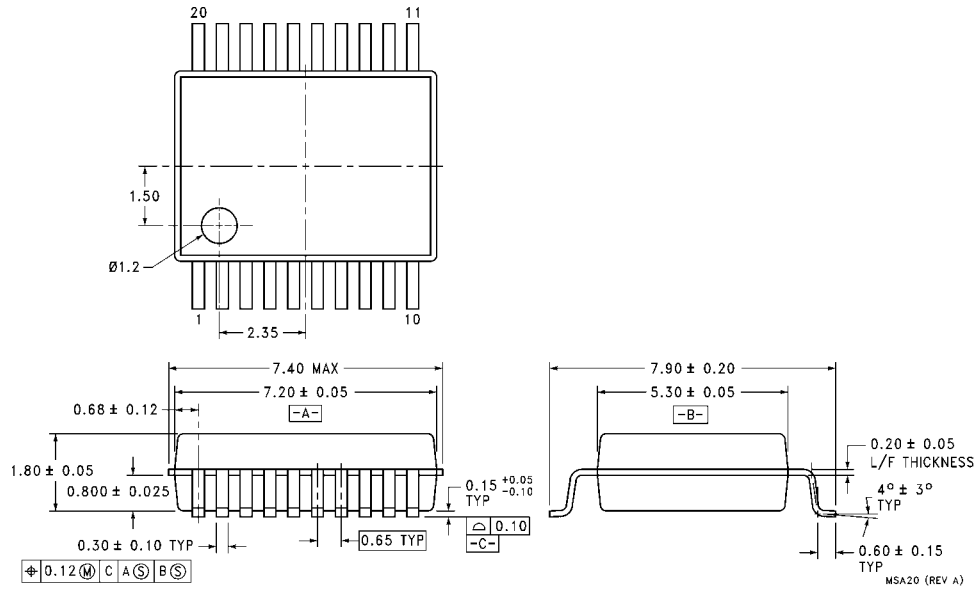

**20-Lead Shrink Small Outline Package (SSOP), EIAJ TYPE II, 5.3mm Wide  
Package Number MSA20**

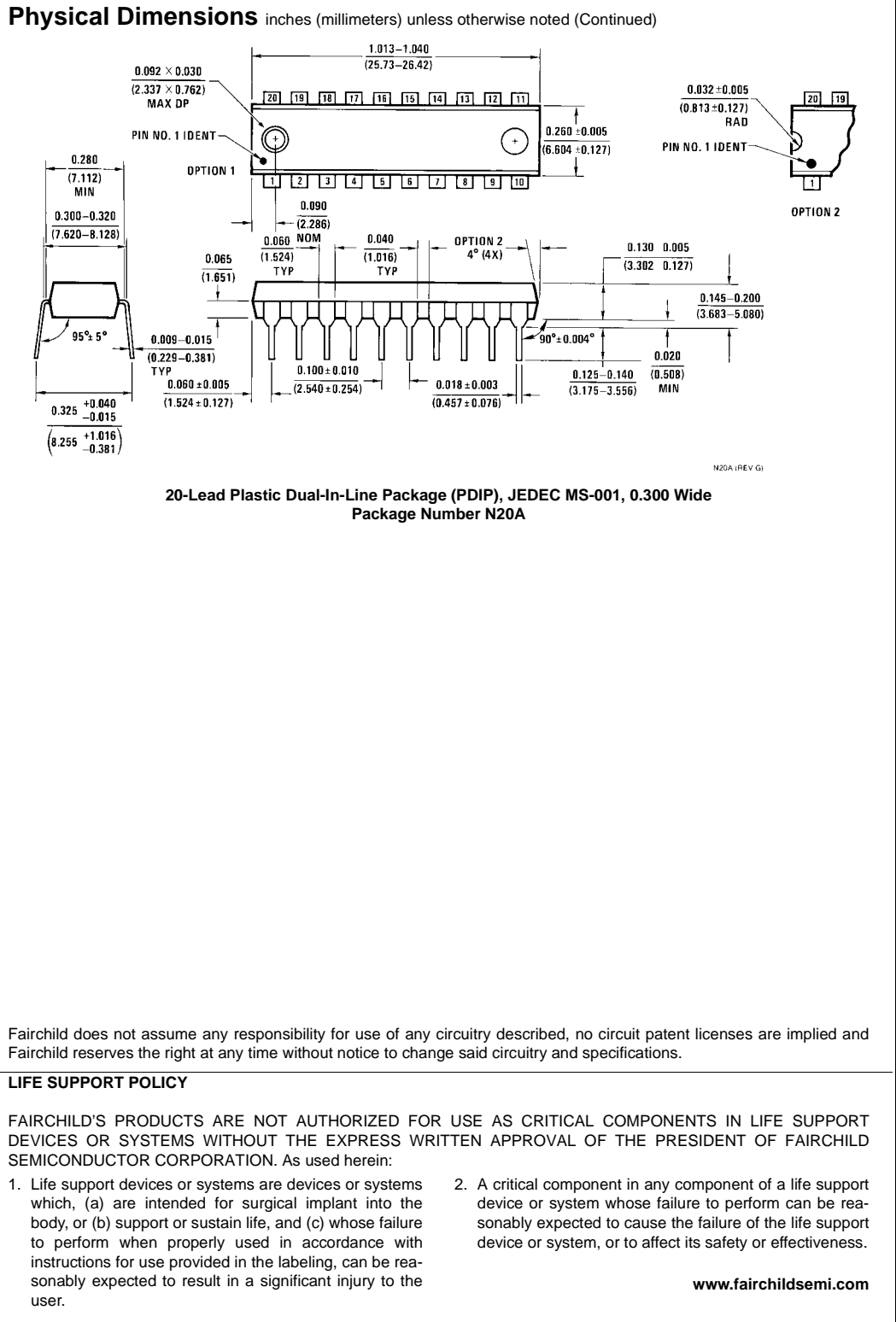

Fairchild does not assume any responsibility for use of any circuitry described, no circuit patent licenses are implied and Fairchild reserves the right at any time without notice to change said circuitry and specifications.

**LIFE SUPPORT POLICY**

FAIRCHILD'S PRODUCTS ARE NOT AUTHORIZED FOR USE AS CRITICAL COMPONENTS IN LIFE SUPPORT DEVICES OR SYSTEMS WITHOUT THE EXPRESS WRITTEN APPROVAL OF THE PRESIDENT OF FAIRCHILD SEMICONDUCTOR CORPORATION. As used herein:

1. Life support devices or systems are devices or systems which, (a) are intended for surgical implant into the body, or (b) support or sustain life, and (c) whose failure to perform when properly used in accordance with instructions for use provided in the labeling, can be reasonably expected to result in a significant injury to the user.
2. A critical component in any component of a life support device or system whose failure to perform can be reasonably expected to cause the failure of the life support device or system, or to affect its safety or effectiveness.

[www.fairchildsemi.com](http://www.fairchildsemi.com)