



80mW, DirectDrive, Stereo Headphone Amplifier with Common-Mode Sense

General Description

The MAX4409 stereo headphone amplifier combines Maxim's DirectDrive architecture and a common-mode sense input, which allows the amplifier to reject common-mode noise. Conventional headphone amplifiers require a bulky DC-blocking capacitor between the headphone and the amplifier. DirectDrive produces a ground-referenced output from a single supply, eliminating the need for large DC-blocking capacitors, which saves cost, board space, and component height. The common-mode voltage sensing corrects for any difference between SGND of the amplifier and the headphone return. This feature minimizes ground-loop noise when the HP socket is used as a line out connection to other grounded equipment, for example, a PC connected to a home hi-fi system.

The MAX4409 draws only 5mA of supply current, delivers up to 80mW per channel into a 16Ω load, and has a low 0.002% THD+N. A high 86dB power-supply rejection ratio allows this device to operate from noisy digital supplies without additional power-supply conditioning. The MAX4409 includes ±8kV ESD protection on the headphone outputs. Comprehensive click-and-pop circuitry eliminates audible clicks and pops on startup and shutdown. A low-power shutdown mode reduces supply current draw to only 6μA.

The MAX4409 operates from a single 1.8V to 3.6V supply, has short-circuit and thermal overload protection, and is specified over the extended -40°C to +85°C temperature range. The MAX4409 is available in tiny 20-pin thin QFN and 14-pin TSSOP packages.

Applications

- Notebooks
- Desktop PCs
- Cellular Phones
- PDAs
- MP3 Players
- Tablet PCs
- Portable Audio Equipment

Features

- ◆ No Bulky DC-Blocking Capacitors Required
- ◆ Ground-Referenced Outputs Eliminate DC-Bias Voltages on Headphone Ground Pin
- ◆ Common-Mode Voltage Sensing Eliminates Ground-Loop Noise
- ◆ 96dB CMRR
- ◆ No Degradation of Low-Frequency Response Due to Output Capacitors
- ◆ 80mW per Channel into 16Ω
- ◆ Low 0.002% THD+N
- ◆ High 86dB PSRR
- ◆ Integrated Click-and-Pop Suppression
- ◆ 1.8V to 3.6V Single-Supply Operation
- ◆ Low Quiescent Current
- ◆ Low-Power Shutdown Mode
- ◆ Short-Circuit and Thermal-Overload Protection
- ◆ ±8kV ESD-Protected Amplifier Outputs
- ◆ Available in Space-Saving Packages
 - 14-Pin TSSOP
 - 20-Pin Thin QFN

Ordering Information

PART	TEMP RANGE	PIN-PACKAGE
MAX4409ETP	-40°C to +85°C	20 Thin QFN-EP*
MAX4409EUD	-40°C to +85°C	14 TSSOP

*EP = Exposed paddle.

Functional Diagram

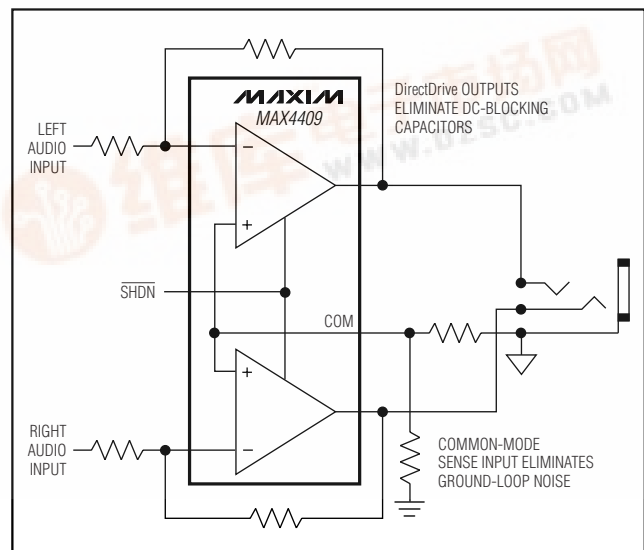

Pin Configurations and Typical Application Circuit appear at end of data sheet.

80mW, DirectDrive, Stereo Headphone Amplifier with Common-Mode Sense

ABSOLUTE MAXIMUM RATINGS

PGND to SGND	-0.3V to +0.3V	C1N to PGND	(PVSS - 0.3V) to (PGND + 0.3V)
PVDD to SVDD	-0.3V to +0.3V	Output Short Circuit to GND or VDD	Continuous
PVSS to SVSS	-0.3V to +0.3V	Continuous Power Dissipation (T _A = +70°C)	
PVDD and SVDD to PGND or SGND	-0.3V to +4V	14-Pin TSSOP (derate 9.1mW/°C above +70°C)	727mW
PVSS and SVSS to PGND or SGND	-4V to +0.3V	20-Pin Thin QFN (derate 16.9mW/°C above +70°C) ..	1349mW
IN ₋ and COM to SGND	SVSS to (SVDD - 1V)	Junction Temperature	+150°C
IN ₋ to COM	(COM + 2V) to (COM - 0.3V)	Operating Temperature Range	-40°C to +85°C
SHDN ₋ to SGND	(SGND - 0.3V) to (SVDD + 0.3V)	Storage Temperature Range	-65°C to +150°C
OUT ₋ to SGND	(SVSS - 0.3V) to (SVDD + 0.3V)	Lead Temperature (soldering, 10s)	+300°C
C1P to PGND	(PGND - 0.3V) to (PVDD + 0.3V)		

Stresses beyond those listed under "Absolute Maximum Ratings" may cause permanent damage to the device. These are stress ratings only, and functional operation of the device at these or any other conditions beyond those indicated in the operational sections of the specifications is not implied. Exposure to absolute maximum rating conditions for extended periods may affect device reliability.

ELECTRICAL CHARACTERISTICS

(PVDD = SVDD = 3V, PGND = SGND = 0V, $\overline{\text{SHDN}}$ = SVDD, C1 = C2 = 2.2μF, R_{IN} = R_F = R1 = R2 = 10kΩ, R_L = ∞, T_A = T_{MIN} to T_{MAX}, unless otherwise noted. Typical values are at T_A = +25°C.) (Note 1)

PARAMETER	SYMBOL	CONDITIONS	MIN	TYP	MAX	UNITS
Supply Voltage Range	V _{DD}	Guaranteed by PSRR test	1.8		3.6	V
Quiescent Supply Current	I _{DD}			5	8.4	mA
Shutdown Supply Current	I _{SHDN}	$\overline{\text{SHDN}}$ = GND		6	10	μA
$\overline{\text{SHDN}}$ Thresholds		V _{IH}	0.7 x SVDD		0.3 x SVDD	V
		V _{IL}				
$\overline{\text{SHDN}}$ Input Leakage Current			-1		+1	μA
$\overline{\text{SHDN}}$ to Full Operation	t _{SON}			175		μs
CHARGE PUMP						
Oscillator Frequency	f _{OSC}		272	320	368	kHz
AMPLIFIERS						
Input Offset Voltage	V _{OS}	R _L = 32Ω		0.5	2.4	mV
Input Bias Current	I _{BIAS}		-700	-100	0	nA
COM Bias Current	I _{COM}		-1400	-200	0	nA
Equivalent Input Offset Current	I _{OS}	I _{OS} = (I _{BIAS(INR)} + I _{BIAS(INL)} - I _{COM}) / 2		±2		nA
COM Input Range	V _{COM}	Inferred from CMRR test	-500		+500	mV
Common-Mode Rejection Ratio	CMRR	-500mV ≤ V _{COM} ≤ +500mV, R _{SOURCE} ≤ 10Ω	75	96		dB
Power-Supply Rejection Ratio	PSRR	1.8V ≤ V _{DD} ≤ 3.6V	DC (Note 2)	75	86	dB
		V _{DD} = 3.0V, 200mV _{P-P} ripple	f _{RIPPLE} = 1kHz		76	
			f _{RIPPLE} = 20kHz		48	
Output Power	P _{OUT}	THD+N = 1%, T _A = +25°C	R _L = 32Ω		65	mW
			R _L = 16Ω	55	80	

80mW, DirectDrive, Stereo Headphone Amplifier with Common-Mode Sense

ELECTRICAL CHARACTERISTICS (continued)

($P_{VDD} = S_{VDD} = 3V$, $P_{GND} = S_{GND} = 0V$, $\overline{SHDN} = S_{VDD}$, $C1 = C2 = 2.2\mu F$, $R_{IN} = R_F = R1 = R2 = 10k\Omega$, $R_L = \infty$, $T_A = T_{MIN}$ to T_{MAX} , unless otherwise noted. Typical values are at $T_A = +25^\circ C$.) (Note 1)

PARAMETER	SYMBOL	CONDITIONS	MIN	TYP	MAX	UNITS
Total Harmonic Distortion Plus Noise	THD+N	$f_{IN} = 1kHz$	$R_L = 32\Omega$, $P_{OUT} = 50mW$	0.002		%
			$R_L = 16\Omega$, $P_{OUT} = 60mW$	0.005		
Signal-to-Noise Ratio	SNR	$R_L = 32\Omega$, $P_{OUT} = 20mW$, $f_{IN} = 1kHz$	95			dB
Slew Rate	SR		0.8			V/ μs
Maximum Capacitive Load	C_L	No sustained oscillations	150			pF
Crosstalk		$R_L = 16\Omega$, $P_{OUT} = 1.6mW$, $f_{IN} = 10kHz$	55			dB
Thermal Shutdown Threshold			140			$^\circ C$
Thermal Shutdown Hysteresis			15			$^\circ C$
ESD Protection		Human Body Model (OUTR, OUTL)	± 8			kV

Note 1: All specifications are 100% tested at $T_A = +25^\circ C$; temperature limits are guaranteed by design.

Note 2: Inputs are connected to ground and COM.

Note 3: Inputs are AC-coupled to ground. COM is connected to ground.

Typical Operating Characteristics

($C1 = C2 = 2.2\mu F$, $R_{IN} = R_F = R1 = R2 = 10k\Omega$, THD+N measurement bandwidth = 22Hz to 22kHz, $T_A = +25^\circ C$, unless otherwise noted.)

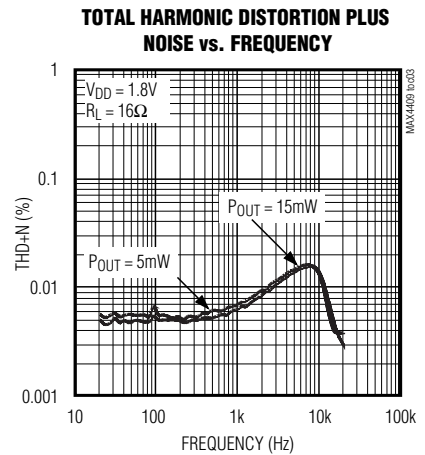
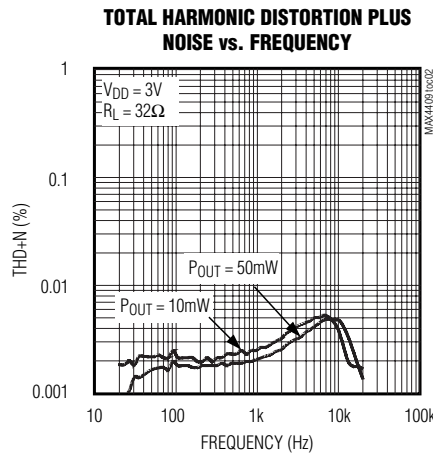
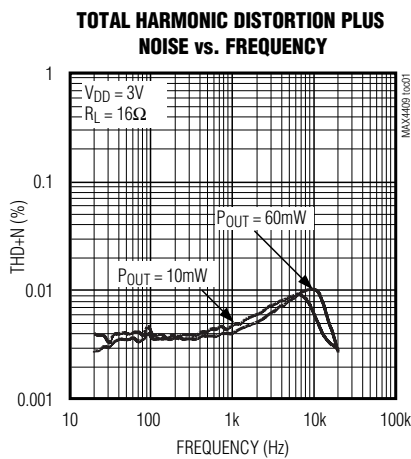

80mW, DirectDrive, Stereo Headphone Amplifier with Common-Mode Sense

Typical Operating Characteristics (continued)

($C1 = C2 = 2.2\mu\text{F}$, $R_{IN} = R_F = R1 = R2 = 10\text{k}\Omega$, THD+N measurement bandwidth = 22Hz to 22kHz, $T_A = +25^\circ\text{C}$, unless otherwise noted.)

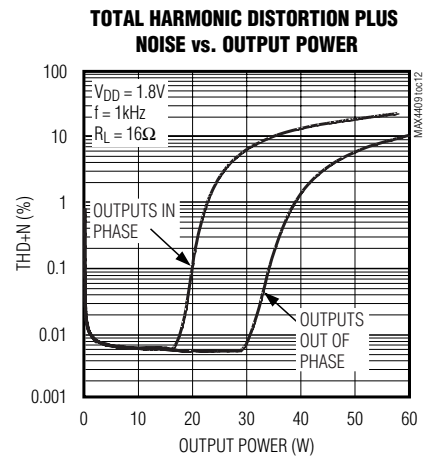
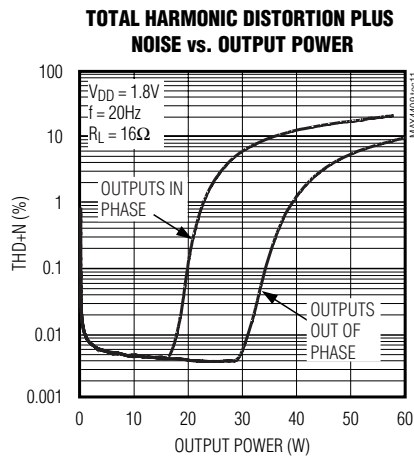
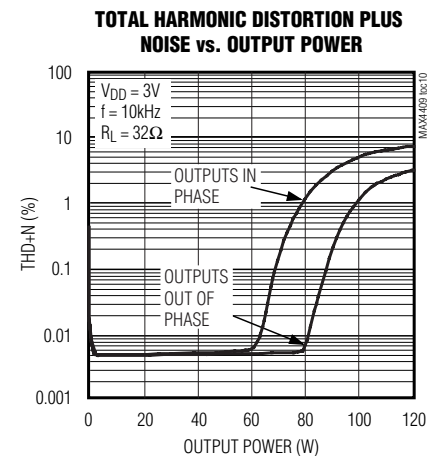
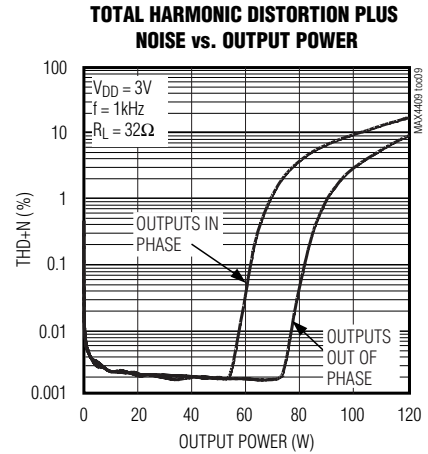
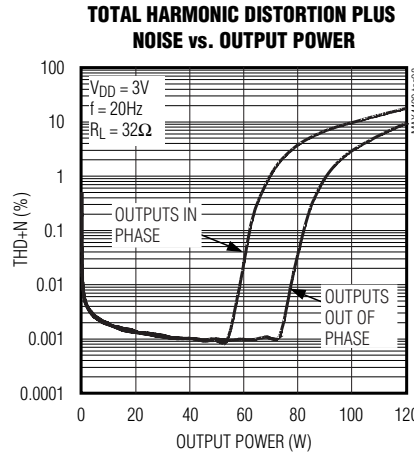
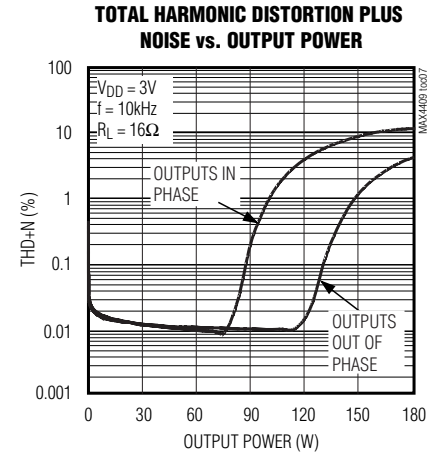
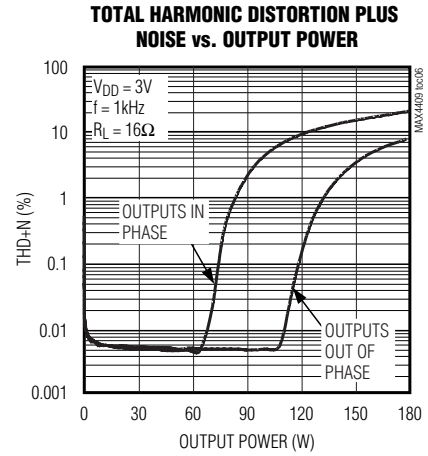
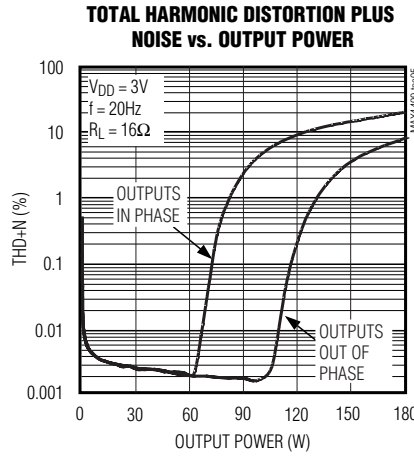
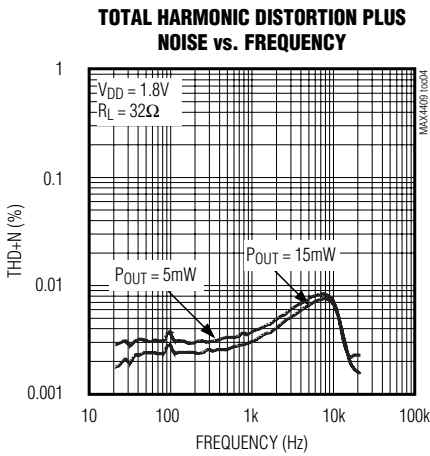

80mW, DirectDrive, Stereo Headphone Amplifier with Common-Mode Sense

Typical Operating Characteristics (continued)

(C1 = C2 = 2.2 μ F, R_{IN} = R_F = R1 = R2 = 10k Ω , THD+N measurement bandwidth = 22Hz to 22kHz, T_A = +25°C, unless otherwise noted.)

MAX4409

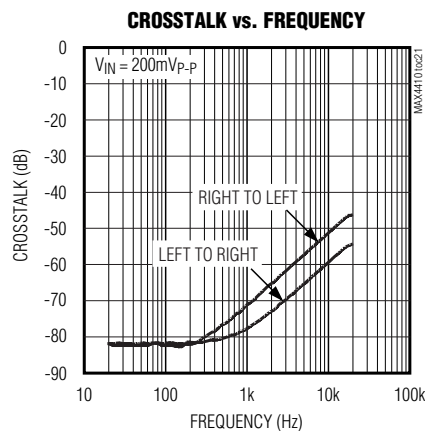
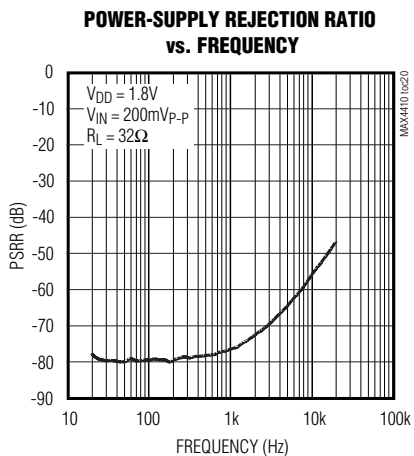
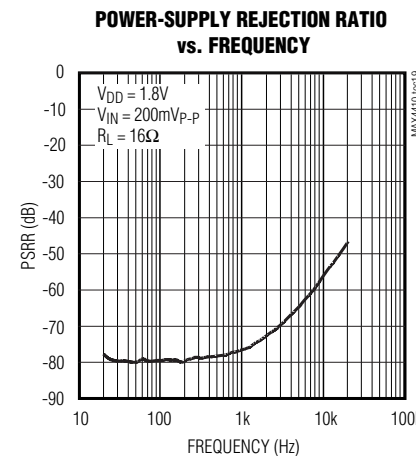
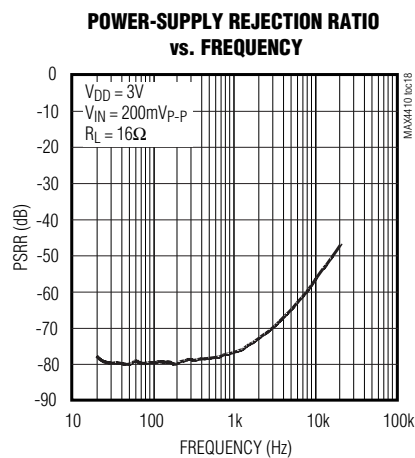
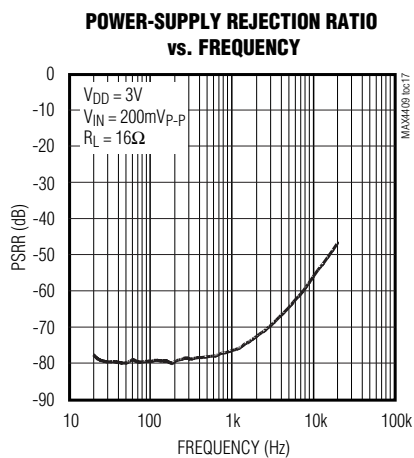
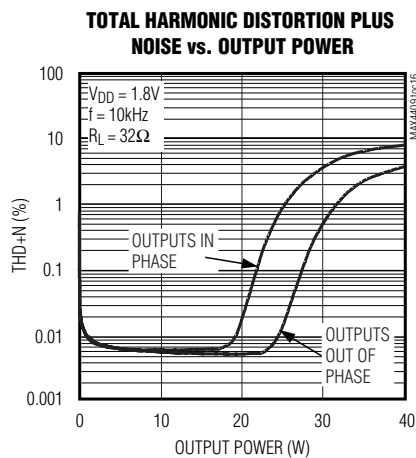
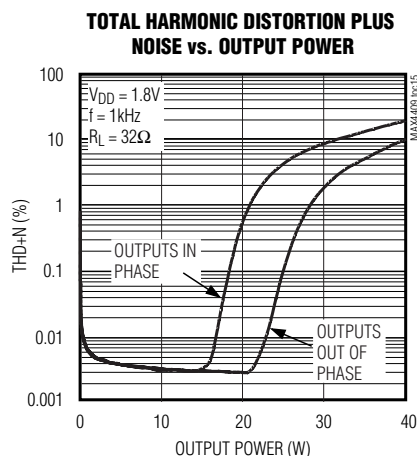
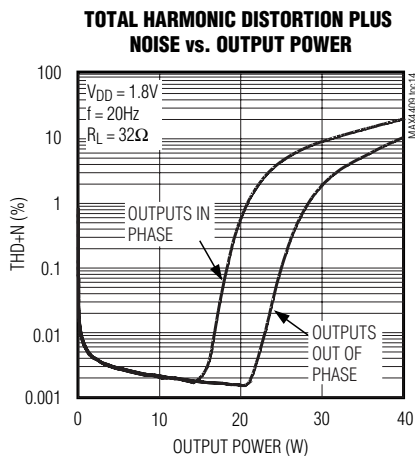
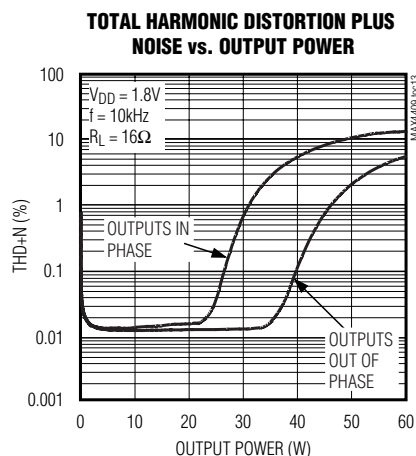

80mW, DirectDrive, Stereo Headphone Amplifier with Common-Mode Sense

Typical Operating Characteristics (continued)

($C1 = C2 = 2.2\mu\text{F}$, $R_{IN} = R_F = R1 = R2 = 10\text{k}\Omega$, THD+N measurement bandwidth = 22Hz to 22kHz, $T_A = +25^\circ\text{C}$, unless otherwise noted.)

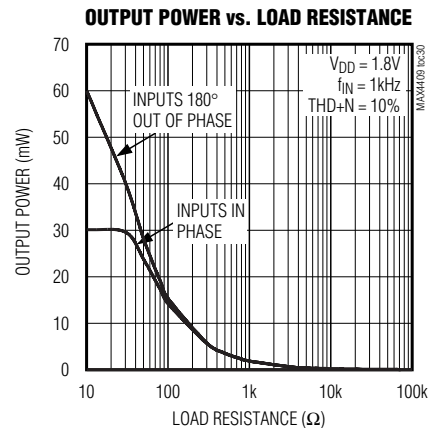
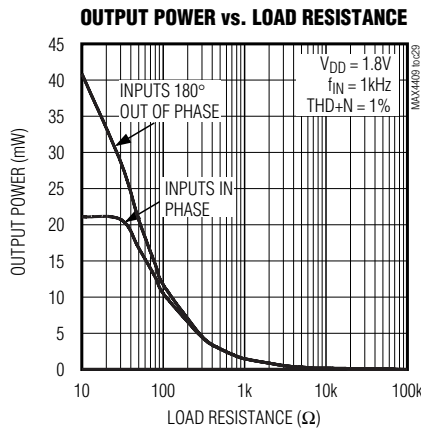
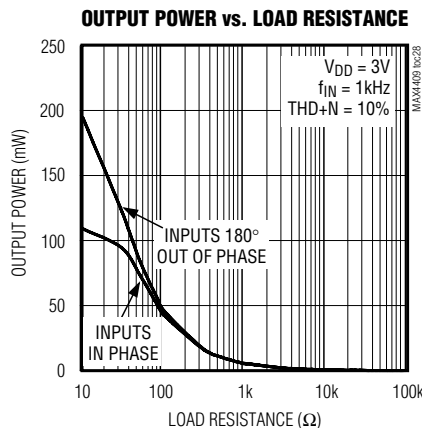
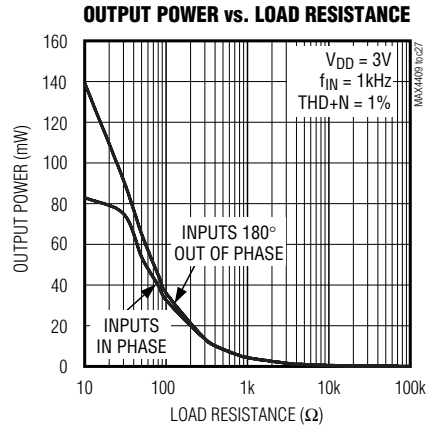
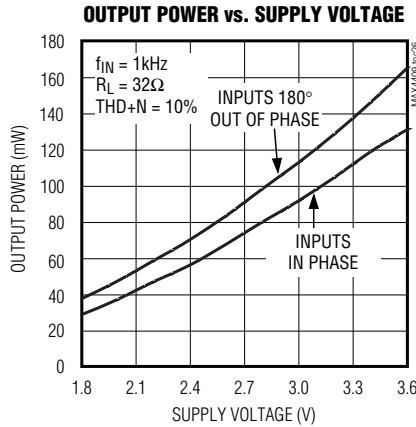
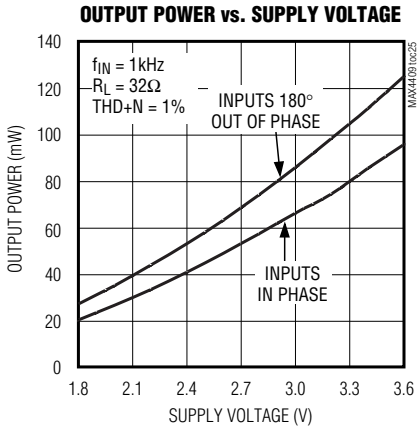
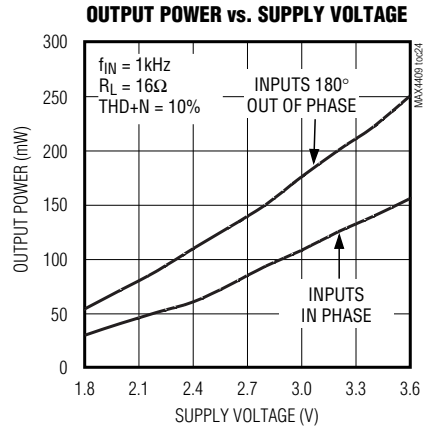
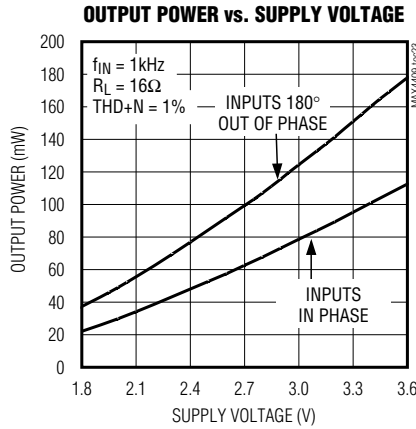
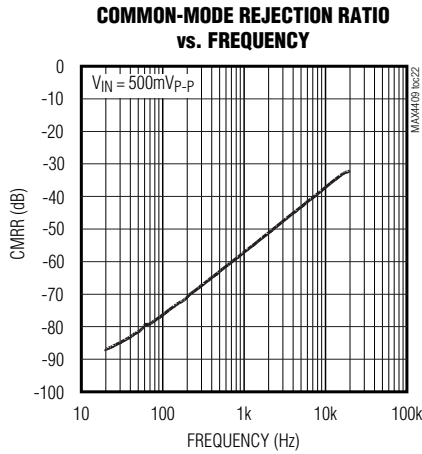

80mW, DirectDrive, Stereo Headphone Amplifier with Common-Mode Sense

MAX4409

Typical Operating Characteristics (continued)

($C1 = C2 = 2.2\mu\text{F}$, $R_{IN} = R_F = R1 = R2 = 10\text{k}\Omega$, THD+N measurement bandwidth = 22Hz to 22kHz, $T_A = +25^\circ\text{C}$, unless otherwise noted.)

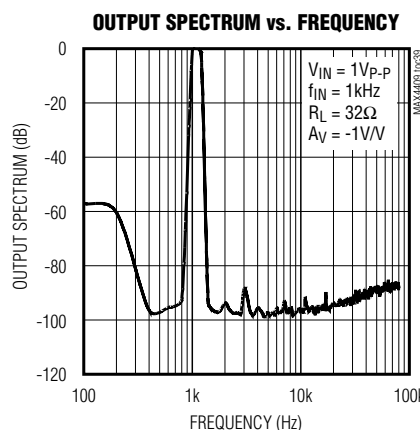
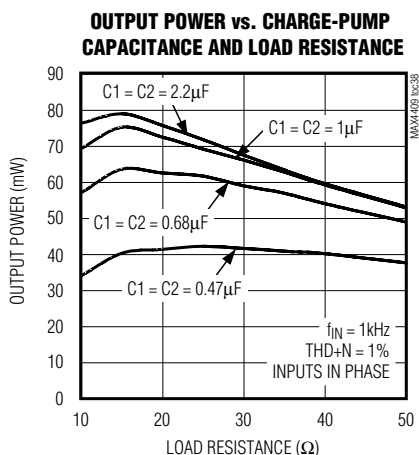
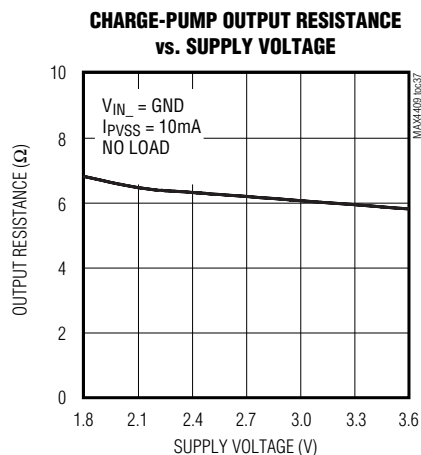
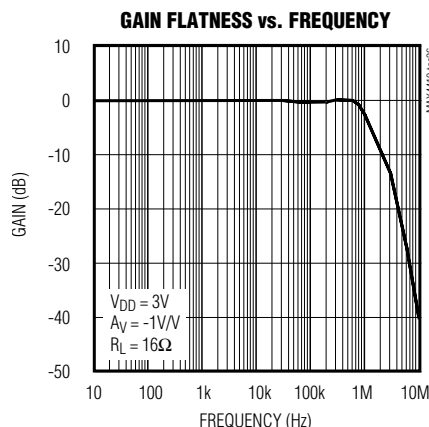
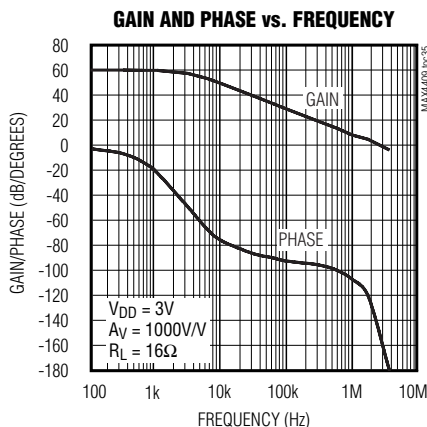
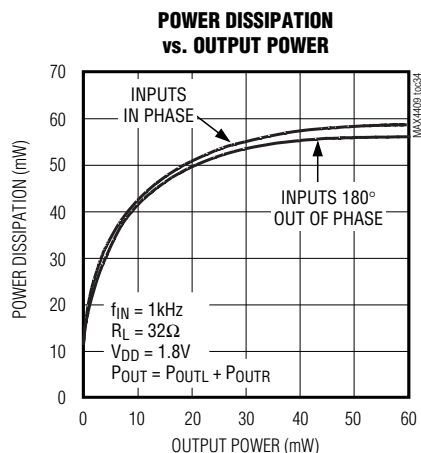
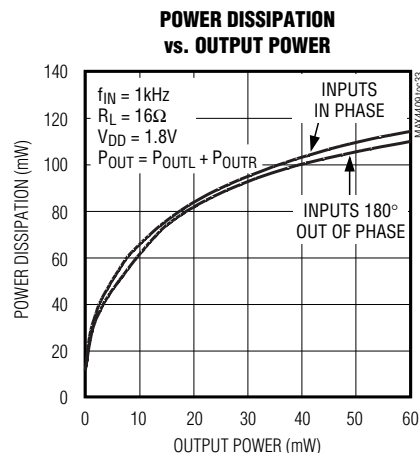
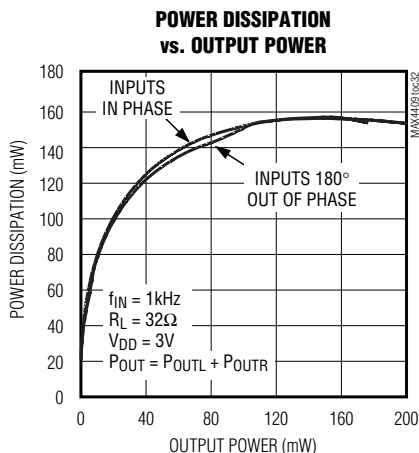
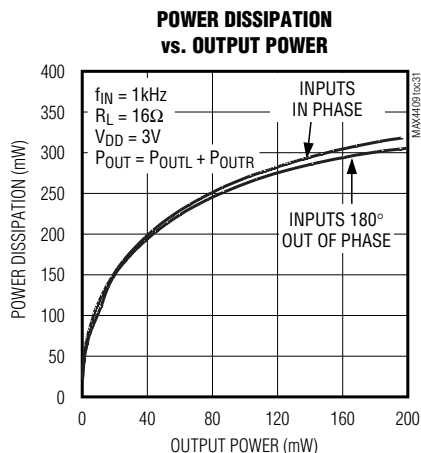

80mW, DirectDrive, Stereo Headphone Amplifier with Common-Mode Sense

Typical Operating Characteristics (continued)

(C1 = C2 = 2.2μF, R_{IN} = R_F = R1 = R2 = 10kΩ, THD+N measurement bandwidth = 22Hz to 22kHz, T_A = +25°C, unless otherwise noted.)

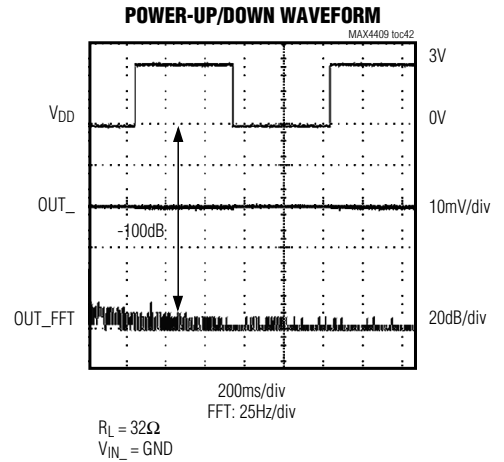
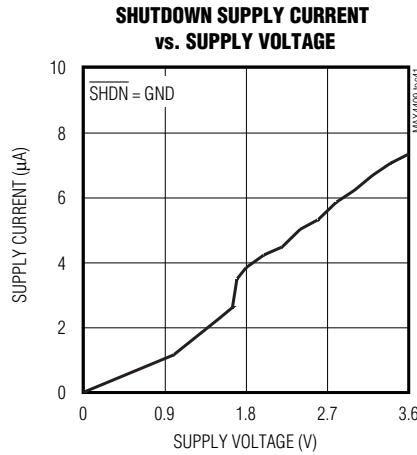
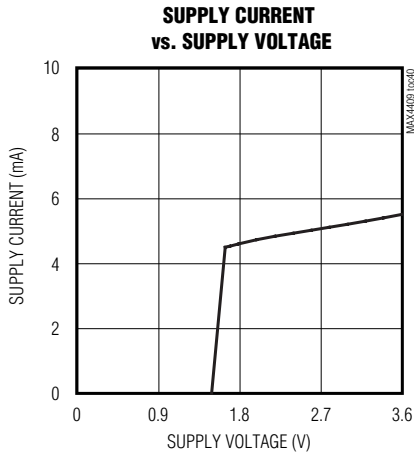

Pin Description

PIN		NAME	FUNCTION
TSSOP	THIN QFN		
1	18	COM	Common-Mode Voltage Sense Input
2	19	PVDD	Charge-Pump Power Supply. Powers charge-pump inverter, charge-pump logic, and oscillator.
3	1	C1P	Flying Capacitor Positive Terminal
4	2	PGND	Power Ground. Connect to SGND.
5	3	C1N	Flying Capacitor Negative Terminal
6	5	PVSS	Charge-Pump Output
7	7	SVSS	Amplifier Negative Power Supply. Connect to PVSS.
8	9	OUTL	Left-Channel Output
9	10	SVDD	Amplifier Positive Power Supply. Connect to PVDD.
10	13	INL	Left-Channel Audio Input
11	11	OUTR	Right-Channel Output
12	14	SHDN	Active-Low Shutdown. Connect to VDD for normal operation.
13	15	INR	Right-Channel Audio Input
14	17	SGND	Signal Ground. Connect to PGND.
—	4, 6, 8, 12, 16, 20	N.C.	No Connection. Not internally connected.
—	—	EP	Exposed Paddle. Leave this connection floating. Do not connect to VDD or GND.

80mW, DirectDrive, Stereo Headphone Amplifier with Common-Mode Sense

Detailed Description

The MAX4409 stereo headphone driver features Maxim's patented DirectDrive architecture, eliminating the large output-coupling capacitors required by traditional single-supply headphone drivers. The device consists of two 80mW Class AB headphone drivers, undervoltage lockout (UVLO)/shutdown control, charge-pump, and comprehensive click-and-pop suppression circuitry (see *Typical Application Circuit*). The charge pump inverts the positive supply (P_{VDD}), creating a negative supply (P_{VSS}). The headphone drivers operate from these bipolar supplies with their outputs biased about GND (Figure 1). The drivers have almost twice the supply range compared to other 3V single-supply drivers, increasing the available output power. The benefit of this GND bias is that the driver outputs do not have a DC component typically $V_{DD}/2$. Thus, the large DC-blocking capacitors are unnecessary, improving frequency response while conserving board space and system cost.

The MAX4409 also features a common-mode voltage sense input that corrects for mismatch between the SGND of the device and the potential at the headphone jack return. A low-power shutdown mode reduces supply current to 6 μ A. The device features an undervoltage lockout that prevents operation from an insufficient power supply and click-and-pop suppression that eliminates audible transients on startup and shutdown. Additionally, the MAX4409 features thermal overload and short-circuit protection and can withstand ± 8 kV ESD strikes on the output pins.

Common-Mode Sense

When the headphone jack is used as a line out to interface between other equipment (notebooks, desktops, and stereo receivers), potential differences between the equipment grounds can create ground loops and excessive ground current flow. The MAX4409 COM input senses and corrects for the difference between the headphone return and device ground. Connect COM through a resistive voltage-divider between the headphone jack return and SGND of the device (see *Typical Application Circuit*). For optimum common-mode rejection, use the same value resistors for R₁ and R_{IN}, and R₂ and R_F. Improve DC CMRR by adding a capacitor in between with SGND and R₂ (see *Typical Application Circuit*). If ground sensing is not required, connect COM directly to SGND through a 5k Ω resistor.

DirectDrive

Traditional single-supply headphone drivers have their outputs biased about a nominal DC voltage (typically half the supply) for maximum dynamic range. Large coupling capacitors are needed to block this DC bias

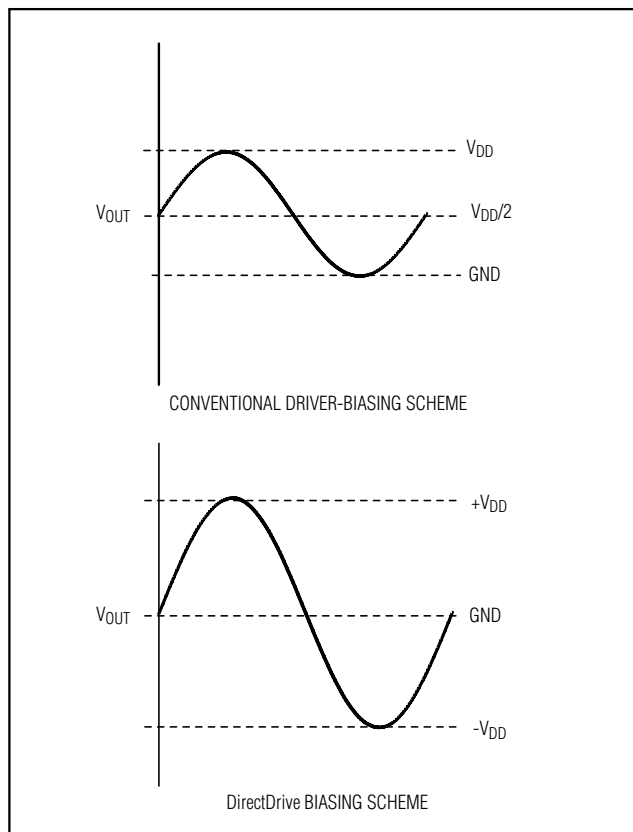

Figure 1. Traditional Driver Output Waveform vs. MAX4409 Output Waveform

from the headphone. Without these capacitors, a significant amount of DC current flows to the headphone, resulting in unnecessary power dissipation and possible damage to both headphone and headphone driver.

Maxim's patented DirectDrive architecture uses a charge pump to create an internal negative supply voltage. This allows the outputs of the MAX4409 to be biased about GND, almost doubling dynamic range while operating from a single supply. With no DC component, there is no need for the large DC-blocking capacitors. Instead of two large (220 μ F, typ) tantalum capacitors, the MAX4409 charge pump requires two small ceramic capacitors, thereby conserving board space, reducing cost, and improving the frequency response of the headphone driver. See the Output Power vs. Charge-Pump Capacitance and Load Resistance graph in the *Typical Operating Characteristics* for details of the possible capacitor sizes. There is a low DC voltage on the driver outputs due to amplifier offset. However, the offset of the MAX4409 is

80mW, DirectDrive, Stereo Headphone Amplifier with Common-Mode Sense

typically 0.5mV, which, when combined with a 32Ω load, results in less than 16μA of DC current flow to the headphones.

Previous attempts to eliminate the output-coupling capacitors involved biasing the headphone return (sleeve) to the DC-bias voltage of the headphone amplifiers. This method raises some issues:

- When combining a microphone and headphone on a single connector, the microphone bias scheme typically requires a 0V reference.
- The sleeve is typically grounded to the chassis. Using this biasing approach, the sleeve must be isolated from system ground, complicating product design.
- During an ESD strike, the driver's ESD structures are the only path to system ground. Thus, the driver must be able to withstand the full ESD strike.
- When using the headphone jack as a line out to other equipment, the bias voltage on the sleeve may conflict with the ground potential from other equipment, resulting in possible damage to the drivers.

Low-Frequency Response

In addition to the cost and size disadvantages of the DC-blocking capacitors required by conventional headphone amplifiers, these capacitors limit the amplifier's low-frequency response and can distort the audio signal:

- The impedance of the headphone load and the DC-blocking capacitor form a highpass filter with the -3dB point set by:

$$f_{-3dB} = \frac{1}{2\pi R_L C_{OUT}}$$

where R_L is the headphone impedance and C_{OUT} is the DC-blocking capacitor value. The highpass filter is required by conventional single-ended, single power-supply headphone drivers to block the midrail DC bias component of the audio signal from the headphones. The drawback to the filter is that it can attenuate low-frequency signals. Larger values of C_{OUT} reduce this effect but result in physically larger, more expensive capacitors. Figure 2 shows the relationship between the size of C_{OUT} and the resulting low-frequency attenuation. Note that the -3dB point for a 16Ω headphone with a 100μF blocking capacitor is 100Hz, well within the normal audio band, resulting in low-frequency attenuation of the reproduced signal.

- The voltage coefficient of the DC-blocking capacitor contributes distortion to the reproduced audio signal as the capacitance value varies as a function of the voltage change across the capacitor. At low frequencies, the reactance of the capacitor dominates at frequencies below the -3dB point and the voltage coefficient appears as frequency-dependent distortion. Figure 3 shows the THD+N introduced by two different capacitor dielectric types. Note that below 100Hz, THD+N increases rapidly.

The combination of low-frequency attenuation and frequency-dependent distortion compromises audio reproduction in portable audio equipment that emphasizes low-frequency effects such as multimedia lap-

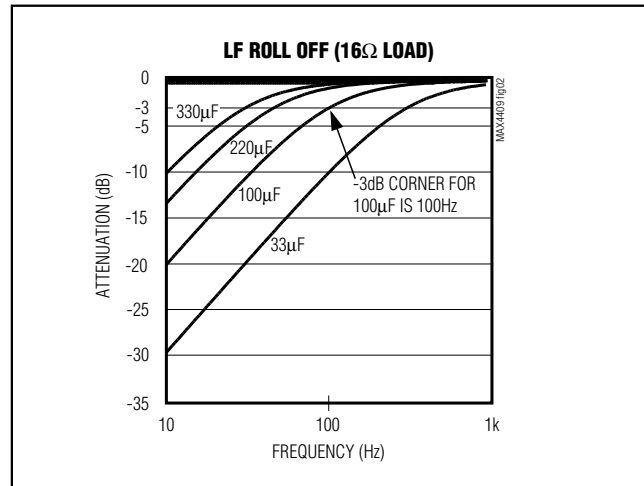

Figure 2. Low-Frequency Attenuation for Common DC-Blocking Capacitor Values

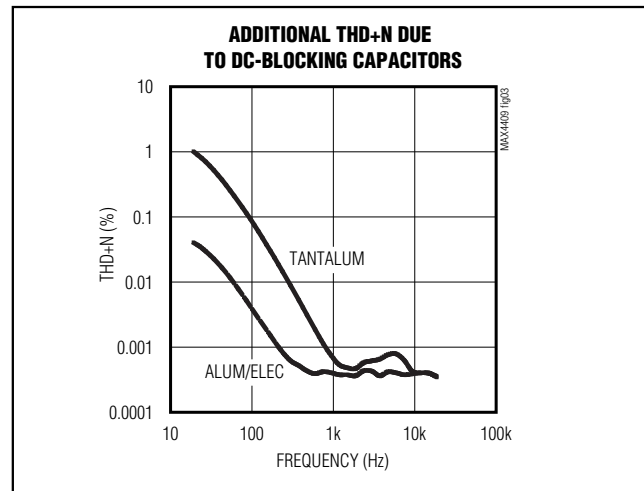

Figure 3. Distortion Contributed by DC-Blocking Capacitors

80mW, DirectDrive, Stereo Headphone Amplifier with Common-Mode Sense

tops, as well as MP3, CD, and DVD players. By eliminating the DC-blocking capacitors through DirectDrive technology, these capacitor-related deficiencies are eliminated.

Charge Pump

The MAX4409 features a low-noise charge pump. The 320kHz switching frequency is well beyond the audio range, and thus does not interfere with the audio signals. The switch drivers feature a controlled switching speed that minimizes noise generated by turn-on and turn-off transients. By limiting the switching speed of the switches, the di/dt noise caused by the parasitic bond wire and trace inductance is minimized. Although not typically required, additional high-frequency noise attenuation can be achieved by increasing the size of C2 (see *Typical Application Circuit*).

Shutdown

The MAX4409 features an active-low $\overline{\text{SHDN}}$ control. Driving $\overline{\text{SHDN}}$ low disables the charge pump and amplifiers, sets the amplifier output impedance to approximately 1k Ω , and reduces supply current draw to less than 6 μA .

Click-and-Pop Suppression

In traditional single-supply audio drivers, the output-coupling capacitor is a major contributor of audible clicks and pops. Upon startup, the driver charges the coupling capacitor to its bias voltage, typically half the supply. Likewise, on shutdown the capacitor is discharged to GND. This results in a DC shift across the capacitor, which in turn, appears as an audible transient at the speaker. Since the MAX4409 does not require output-coupling capacitors, this does not arise.

Additionally, the MAX4409 features extensive click-and-pop suppression that eliminates any audible transient sources internal to the device. The Power-Up/Down Waveform in the *Typical Operating Characteristics* shows that there are minimal spectral components in the audible range at the output upon startup or shutdown.

In most applications, the output of the preamplifier driving the MAX4409 has a DC bias of typically half the supply. At startup, the input-coupling capacitor is charged to the preamplifier's DC-bias voltage through the R_F of the MAX4409, resulting in a DC shift across the capacitor and an audible click/pop. Delaying the rise of the $\overline{\text{SHDN}}$ signals 4 to 5 time constants (40ms to 50ms) based on R_{IN} and C_{IN} relative to the start of the preamplifier eliminates this click/pop caused by the input filter.

Applications Information

Power Dissipation

Under normal operating conditions, linear power amplifiers can dissipate a significant amount of power. The maximum power dissipation for each package is given in the *Absolute Maximum Ratings* section under Continuous Power Dissipation or can be calculated by the following equation:

$$P_{\text{DISSPKG(MAX)}} = \frac{T_{\text{J(MAX)}} - T_{\text{A}}}{\theta_{\text{JA}}}$$

where T_{J(MAX)} is +150°C, T_A is the ambient temperature, and θ_{JA} is the reciprocal of the derating factor in °C/W as specified in the *Absolute Maximum Ratings* section. For example, θ_{JA} of the TSSOP package is +109.9°C/W.

The MAX4409 has two sources of power dissipation, the charge pump and two drivers. If the power dissipation for a given application exceeds the maximum allowed for a given package, either reduce V_{DD}, increase load impedance, decrease the ambient temperature, or add heat sinking to the device. Large output, supply, and ground traces improve the maximum power dissipation in the package.

Thermal overload protection limits total power dissipation in the MAX4409. When the junction temperature exceeds +140°C, the thermal-protection circuitry disables the amplifier output stage. The amplifiers are enabled once the junction temperature cools by 15°C. This results in a pulsing output under continuous thermal-overload conditions.

Output Power

The device has been specified for the worst-case scenario—when both inputs are in phase. Under this condition, the drivers simultaneously draw current from the charge pump, leading to a slight loss in headroom of V_{SS}. In typical stereo audio applications, the left and right signals have differences in both magnitude and phase, subsequently leading to an increase in the maximum attainable output power. Figure 4 shows the two extreme cases for in and out of phase. In reality, the available power lies between these extremes.

Powering Other Circuits from a Negative Supply

An additional benefit of the MAX4409 is the internally generated, negative supply voltage (PV_{SS}). This voltage is used by the MAX4409 to provide the ground-referenced output level. It can, however, also be used to power other devices within a design. Current draw from this negative supply (PV_{SS}) should be limited to 5mA; exceeding this affects the operation of the headphone

80mW, DirectDrive, Stereo Headphone Amplifier with Common-Mode Sense

driver. The negative supply voltage appears on the PVSS pin. A typical application is a negative supply to adjust the contrast of LCD modules.

When considering the use of PVSS in this manner, note that the charge-pump voltage at PVSS is roughly proportional to $-V_{DD}$ and is not a regulated voltage. The charge-pump output impedance plot appears in the *Typical Operating Characteristics*.

Component Selection Gain-Setting Resistors

External feedback components set the gain of the MAX4409. Resistors R_F and R_{IN} (see *Typical Application Circuit*) set the gain of each amplifier as follows:

$$A_V = -\left(\frac{R_F}{R_{IN}}\right)$$

Choose feedback resistor values of 10k Ω . Values other than 10k Ω increase V_{OS} due to the input bias current, which in turn increases the amount of DC current flow to the load. Resistors R_{IN} , R_2 , R_F , and R_1 must be of equal value for best results. Use high-tolerance resistors for best matching and CMRR. For example, the worst-case CMRR attributed to a 1% resistor mismatch is -34dB. This is the worst case, and typical resistors do not affect CMRR as drastically. The effect of resistor mismatch is shown in Figure 5. If all resistors match exactly, then any voltage applied to node A should be duplicated on OUT so no net differential voltage appears between node A (normally the HP jack socket GND) and OUT. For resistors with a tolerance of n%, the worst mismatch is found when R_{IN} and R_1 are at +n%, and R_F and R_2 are at -n%. If all four resistors are nominally the same value, then 2n% of the voltage at A appears between A and OUT.

Packaged resistor arrays can provide well-matched components for this type of application. Although their absolute tolerance is not well controlled, the internal matching of resistors can be very good. At higher frequencies, the rejection is usually limited by PC board layout; care should be taken to make sure any stray capacitance due to PC board traces on node N1 matches those on node N2. Ultimately, CMRR performance is limited by the amplifier itself (see *Electrical Characteristics*).

Compensation Capacitor

The stability of the MAX4409 is affected by the value of the feedback resistor (R_F). The combination of R_F and the input and parasitic trace capacitance introduces an additional pole. Adding a capacitor in parallel with R_F compensates for this pole. Under typical conditions with proper layout, the device is stable without the

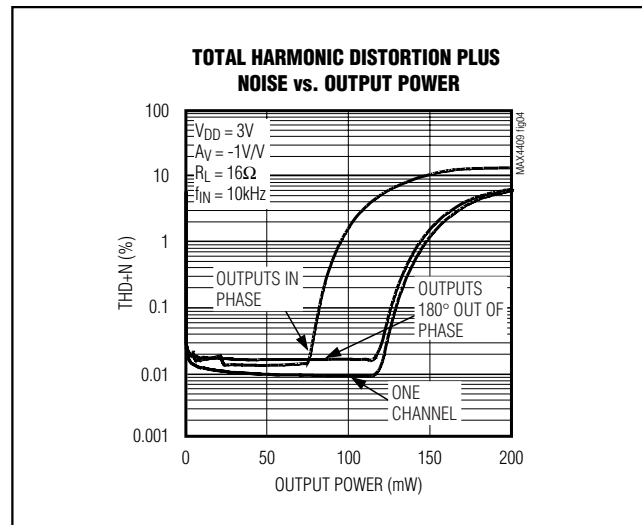

Figure 4. Output Power vs. THD+N with Inputs In/Out of Phase

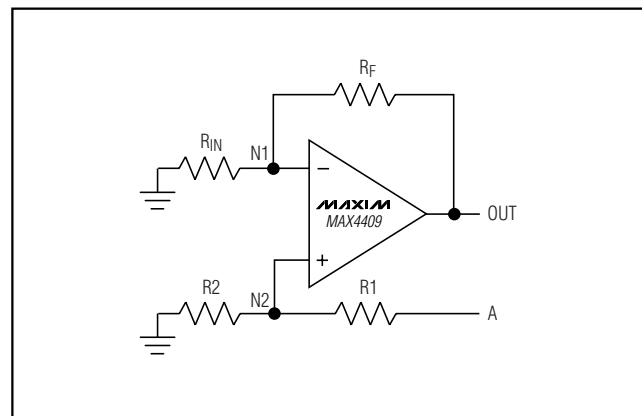

Figure 5. Common-Mode Sense Equivalent Circuit

additional capacitor.

Input Filtering

The input capacitor (C_{IN}), in conjunction with R_{IN} , forms a highpass filter that removes the DC bias from an incoming signal (see *Typical Application Circuit*). The AC-coupling capacitor allows the amplifier to bias the signal to an optimum DC level. Assuming zero-source impedance, the -3dB point of the highpass filter is given by:

$$f_{-3dB} = \frac{1}{2\pi R_{IN} C_{IN}}$$

80mW, DirectDrive, Stereo Headphone Amplifier with Common-Mode Sense

Table 1. Suggested Capacitor Manufacturers

SUPPLIER	PHONE	FAX	WEBSITE
Taiyo Yuden	800-348-2496	847-925-0899	www.t-yuden.com
TDK	847-803-6100	847-390-4405	www.component.tdk.com

Note: Please indicate you are using the MAX4409 when contacting these component suppliers.

Choose R_{IN} according to the *Gain-Setting Resistors* section. Choose the C_{IN} such that f_{-3dB} is well below the lowest frequency of interest. Setting f_{-3dB} too high affects the low-frequency response of the amplifier. Use capacitors whose dielectrics have low-voltage coefficients, such as tantalum or aluminum electrolytic. Capacitors with high-voltage coefficients, such as ceramics, may result in increased distortion at low frequencies.

Charge-Pump Capacitor Selection

Use capacitors with an ESR less than 100m Ω for optimum performance. Low-ESR ceramic capacitors minimize the output resistance of the charge pump. For best performance over the extended temperature range, select capacitors with an X7R dielectric. Table 1 lists suggested manufacturers.

Flying Capacitor (C1)

The value of the flying capacitor (C1) affects the load regulation and output resistance of the charge pump. A C1 value that is too small degrades the device's ability to provide sufficient current drive, which leads to a loss of output voltage. Increasing the value of C1 improves load regulation and reduces the charge-pump output resistance to an extent. See the Output Power vs. Charge-Pump Capacitance and Load Resistance graph in the *Typical Operating Characteristics*. Above 2.2 μ F, the on-resistance of the switches and the ESR of C1 and C2 dominate.

Output Capacitor (C2)

The output capacitor value and ESR directly affect the ripple at PV_{SS} . Increasing the value of C2 reduces output ripple. Likewise, decreasing the ESR of C2 reduces both ripple and output resistance. Lower capacitance values can be used in systems with low maximum output power levels. See the Output Power vs. Charge-Pump Capacitance and Load Resistance graph in the *Typical Operating Characteristics*.

Power-Supply Bypass Capacitor

The power-supply bypass capacitor (C3) lowers the output impedance of the power supply, and reduces the impact of the MAX4409's charge-pump switching transients. Bypass PV_{DD} with C3, the same value as C1, and place it physically close to the PV_{DD} and PGND pins.

Common-Mode Noise Rejection

Figure 6 shows a theoretical connection between two devices, for example, a notebook computer (transmitter, on the left) and an amplifier (receiver, on the right). The application includes the headphone socket used as a line output to a home hi-fi system, for example. In the upper diagram, any difference between the two GND references (represented by V_{NOISE}) causes current to flow through the screen of cable between the two devices. This can cause noise pickup at the receiver due to the potential divider action of the audio screen cable impedance and the GND wiring of the amplifier.

Introducing impedance between the jack socket and GND of the notebook helps (as shown in the lower diagram). This has the following effect:

- Current flow (from GND potential differences) in the cable screen is reduced, which is a safety issue.
- It allows the MAX4409 differential sensing to reduce the GND noise seen by the receiver (amplifier).

The other side effect is the differential HP jack sensing corrects the headphone crosstalk (from introducing the resistance on the jack GND return). Only one channel is depicted in Figure 6.

Figure 6 has some example numbers for resistance, but the audio designer has control over only one series resistance applied to the headphone jack return. Note that this resistance can be bypassed for ESD purposes at frequencies much higher than audio if required. The upper limit for this added resistance is the amount of output swing the headphone amplifier tolerates when driving low-impedance loads. Any headphone return current appears as a voltage across this resistor.

Layout and Grounding

Proper layout and grounding are essential for optimum performance. Connect PGND and SGND together at a single point on the PC board. Connect all components associated with the charge pump (C2 and C3) to the PGND plane. Connect PV_{DD} and SV_{DD} together at the device. Connect PV_{SS} and SV_{SS} together at the device. Bypassing of both supplies is accomplished by charge-pump capacitors C2 and C3 (see *Typical*

80mW, DirectDrive, Stereo Headphone Amplifier with Common-Mode Sense

Application Circuit). Place capacitors C2 and C3 as close to the device as possible. Route PGND and all traces that carry switching transients away from SGND and the traces and components in the audio signal path.

Ensure that the COM traces have the same trace length and width as the amplifier input and feedback traces. Route COM traces away from noisy signal paths. The thin QFN package features an exposed paddle that

improves thermal efficiency of the package. However, the MAX4409 does not require additional heatsinking. Ensure that the exposed paddle is isolated from GND or VDD. **Do not connect the exposed paddle to GND or VDD.**

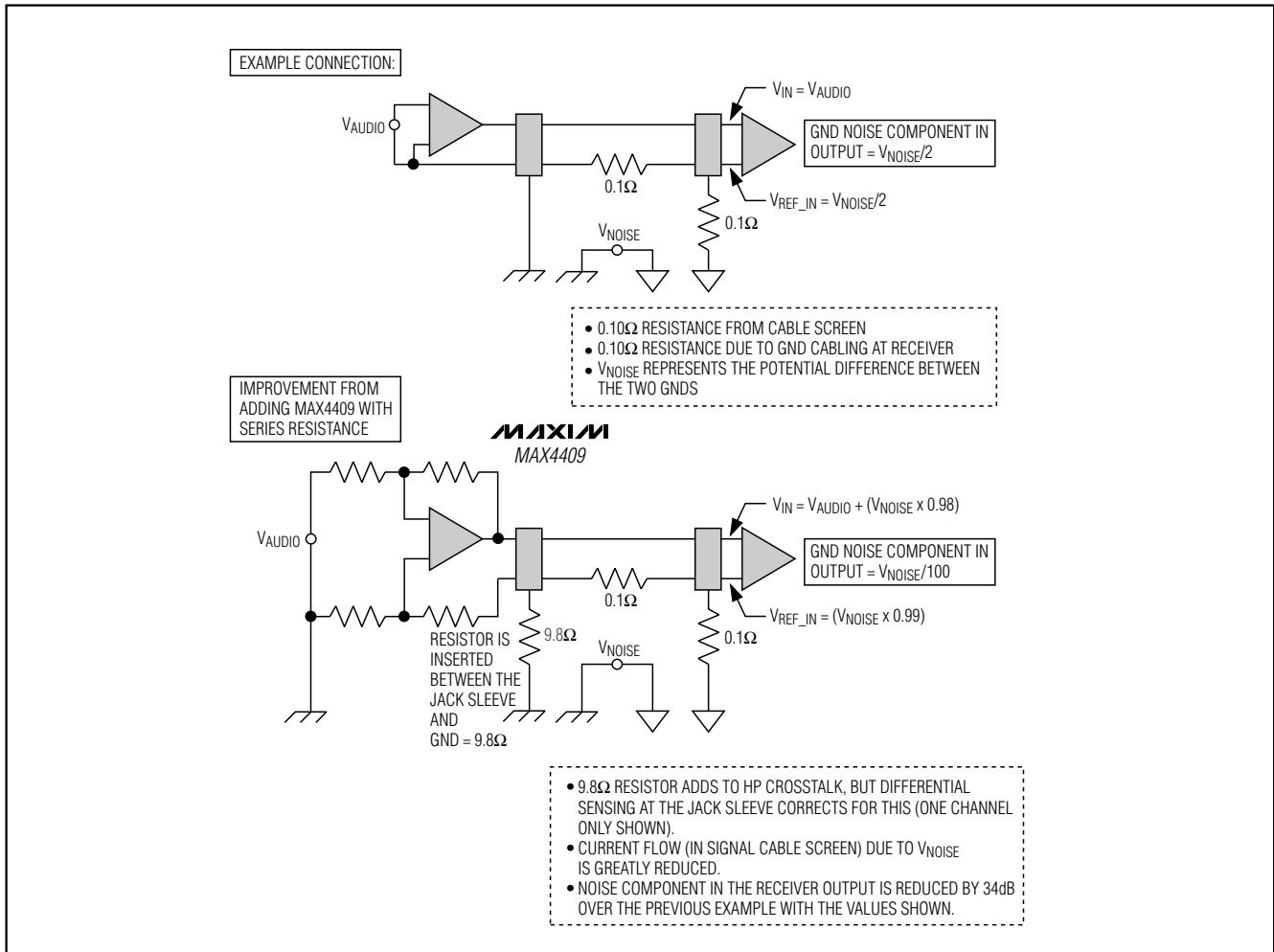
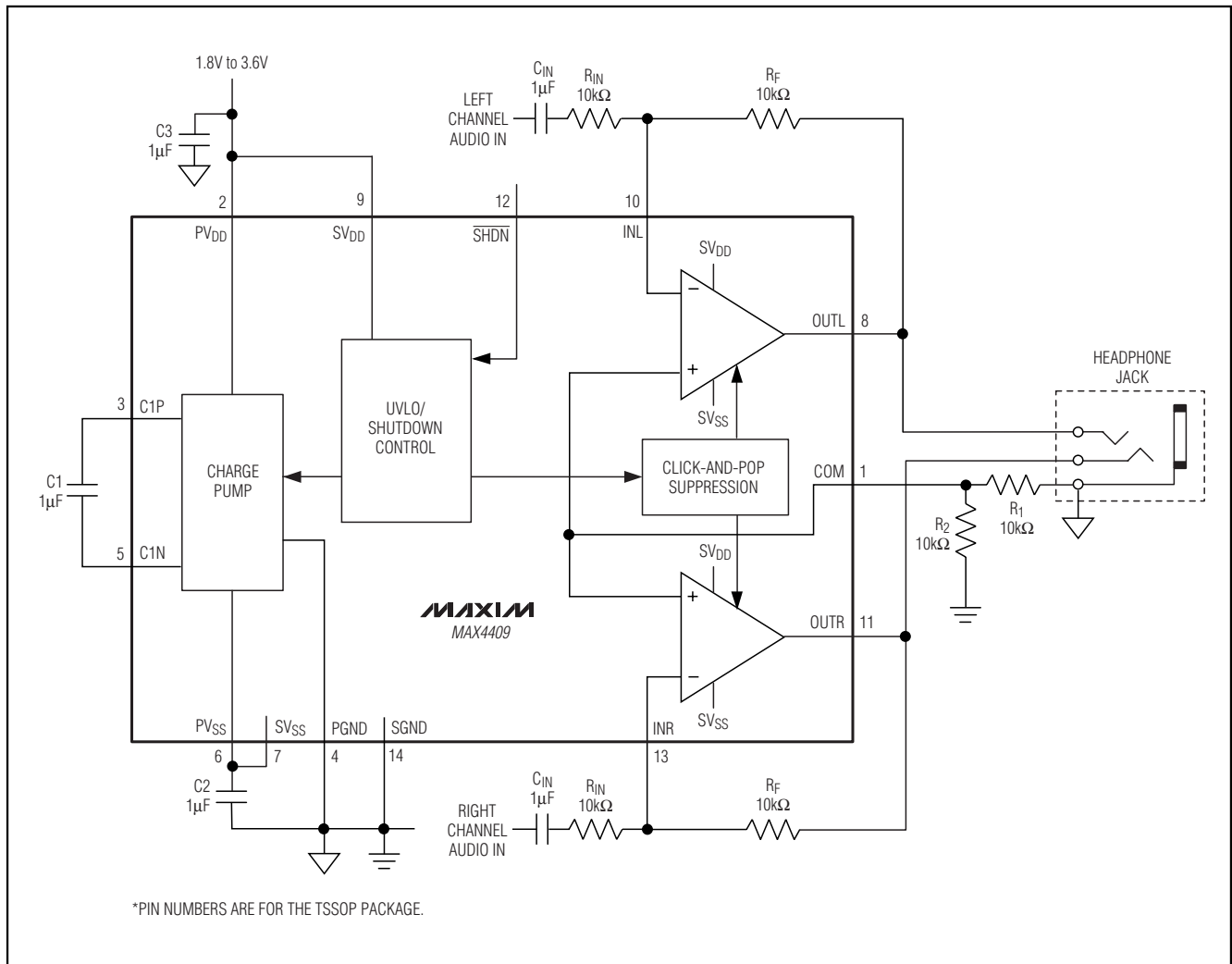

Figure 6. Common-Mode Noise Rejection

80mW, DirectDrive, Stereo Headphone Amplifier with Common-Mode Sense

Typical Application Circuit

MAX4409



80mW, DirectDrive, Stereo Headphone Amplifier with Common-Mode Sense

System Diagram

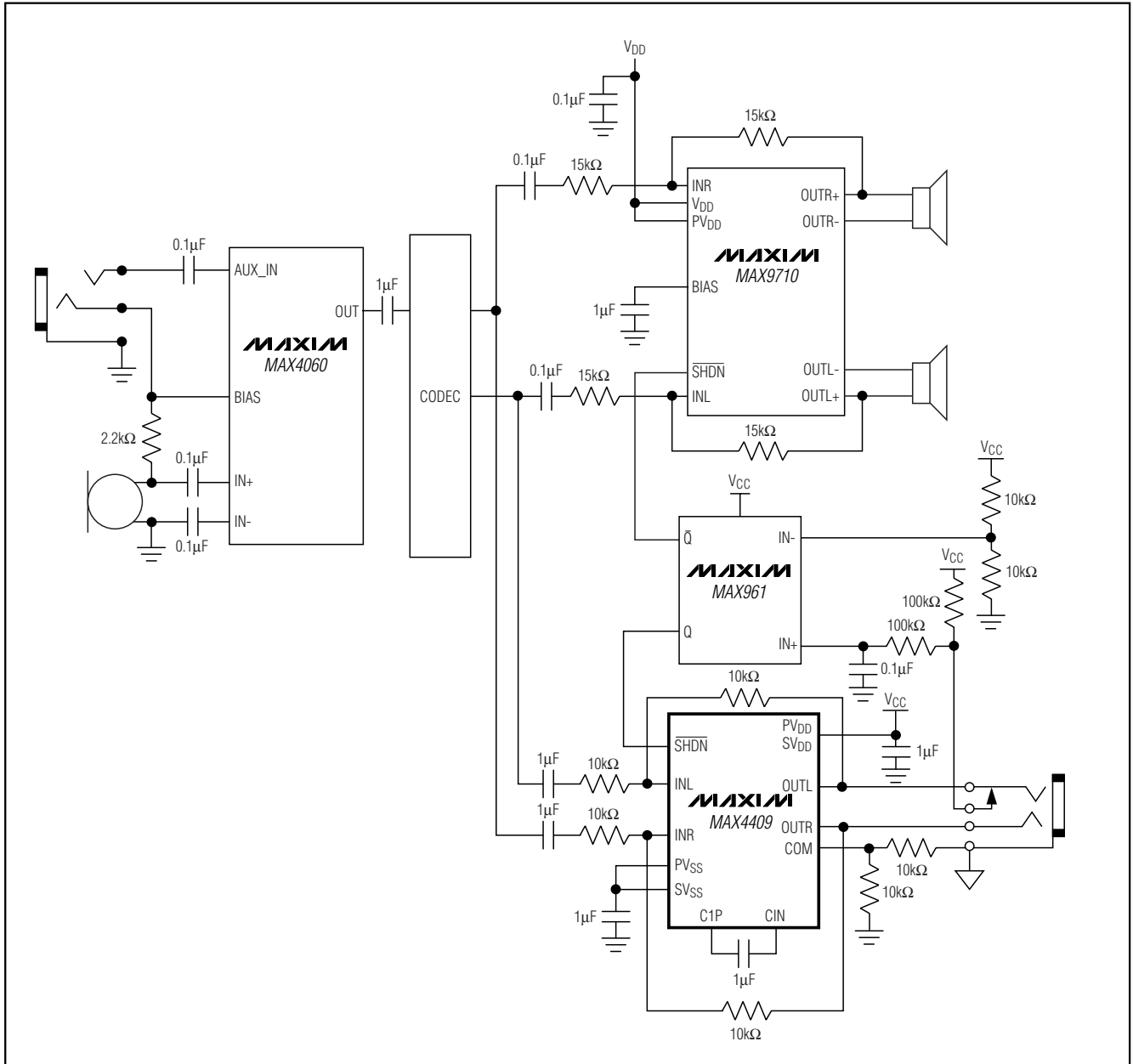

80mW, DirectDrive, Stereo Headphone Amplifier with Common-Mode Sense

Pin Configurations

MAX4409

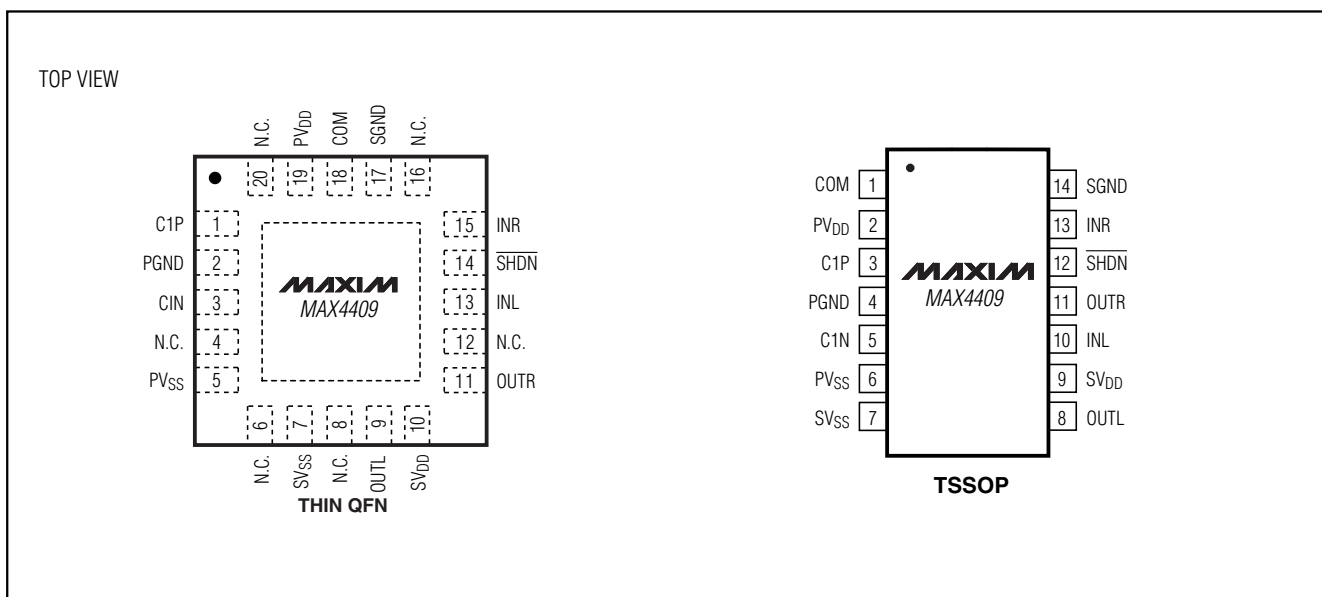

Chip Information

TRANSISTOR COUNT: 4295

PROCESS: BiCMOS

80mW, DirectDrive, Stereo Headphone Amplifier with Common-Mode Sense

Package Information

(The package drawing(s) in this data sheet may not reflect the most current specifications. For the latest package outline information, go to www.maxim-ic.com/packages.

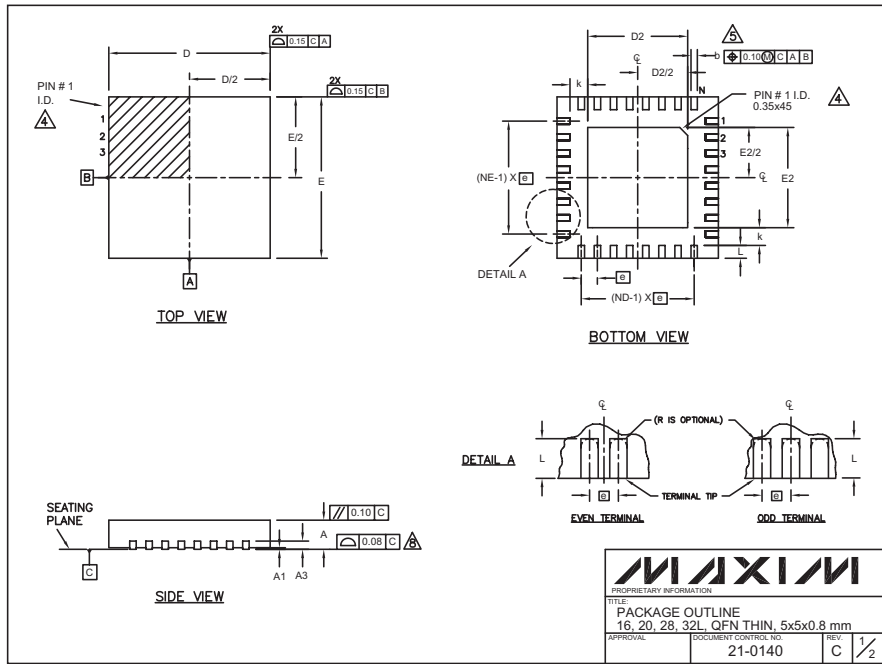

COMMON DIMENSIONS												
PKG.	16L 5x5			20L 5x5			28L 5x5			32L 5x5		
SYMBOL	MIN.	NOM.	MAX.	MIN.	NOM.	MAX.	MIN.	NOM.	MAX.	MIN.	MAX.	
A	0.70	0.75	0.80	0.70	0.75	0.80	0.70	0.75	0.80	0.70	0.80	
A1	0	0.02	0.05	0	0.02	0.05	0	0.02	0.05	0	0.05	
A3	0.20 REF.			0.20 REF.			0.20 REF.			0.20 REF.		
b	0.25	0.30	0.35	0.25	0.30	0.35	0.20	0.25	0.30	0.20	0.30	
D	4.90	5.00	5.10	4.90	5.00	5.10	4.90	5.00	5.10	4.90	5.00	
E	4.90	5.00	5.10	4.90	5.00	5.10	4.90	5.00	5.10	4.90	5.00	
e	0.80 BSC.			0.85 BSC.			0.50 BSC.			0.50 BSC.		
k	0.25	-	-	0.25	-	-	0.25	-	-	0.25	-	
L	0.45	0.55	0.65	0.45	0.55	0.65	0.45	0.55	0.65	0.30	0.40	
N	16			20			28			32		
ND	4			5			7			8		
NE	4			5			7			8		
JEDEC	WHHB			WHHC			WHHD-1			WHHD-2		

EXPOSED PAD VARIATIONS							
PKG. CODES	D2			E2			MAX.
	MIN.	NOM.	MAX.	MIN.	NOM.	MAX.	
T1655-1	3.00	3.10	3.20	3.00	3.10	3.20	3.20
T2055-2	3.00	3.10	3.20	3.00	3.10	3.20	3.20
T2855-1	3.15	3.25	3.35	3.15	3.25	3.35	3.35
T2855-2	2.60	2.70	2.80	2.60	2.70	2.80	2.80
T3255-2	3.00	3.10	3.20	3.00	3.10	3.20	3.20

NOTES:

- DIMENSIONING & TOLERANCING CONFORM TO ASME Y14.5M-1994.
- ALL DIMENSIONS ARE IN MILLIMETERS. ANGLES ARE IN DEGREES.
- N IS THE TOTAL NUMBER OF TERMINALS.
- THE TERMINAL #1 IDENTIFIER AND TERMINAL NUMBERING CONVENTION SHALL CONFORM TO JESD 55-1 SPP-012. DETAILS OF TERMINAL #1 IDENTIFIER ARE OPTIONAL, BUT MUST BE LOCATED WITHIN THE ZONE INDICATED. THE TERMINAL #1 IDENTIFIER MAY BE EITHER A MOLD OR MARKED FEATURE.
- DIMENSION b APPLIES TO METALLIZED TERMINAL AND IS MEASURED BETWEEN 0.25 mm AND 0.30 mm FROM TERMINAL TIP.
- ND AND NE REFER TO THE NUMBER OF TERMINALS ON EACH D AND E SIDE RESPECTIVELY.
- DEPOPULATION IS POSSIBLE IN A SYMMETRICAL FASHION.
- COPLANARITY APPLIES TO THE EXPOSED HEAT SINK SLUG AS WELL AS THE TERMINALS.
- DRAWING CONFORMS TO JEDEC MO220.
- WARPAGE SHALL NOT EXCEED 0.10 mm.

MAXIM
PROPRIETARY INFORMATION

TITLE: PACKAGE OUTLINE
16, 20, 28, 32L, QFN THIN, 5x5x0.8 mm

APPROVAL: [] DOCUMENT CONTROL NO: 21-0140 REV: C 2/2

80mW, DirectDrive, Stereo Headphone Amplifier with Common-Mode Sense

Package Information (continued)

(The package drawing(s) in this data sheet may not reflect the most current specifications. For the latest package outline information, go to www.maxim-ic.com/packages.

MAX4409

TSSOP4.40mm.EPS

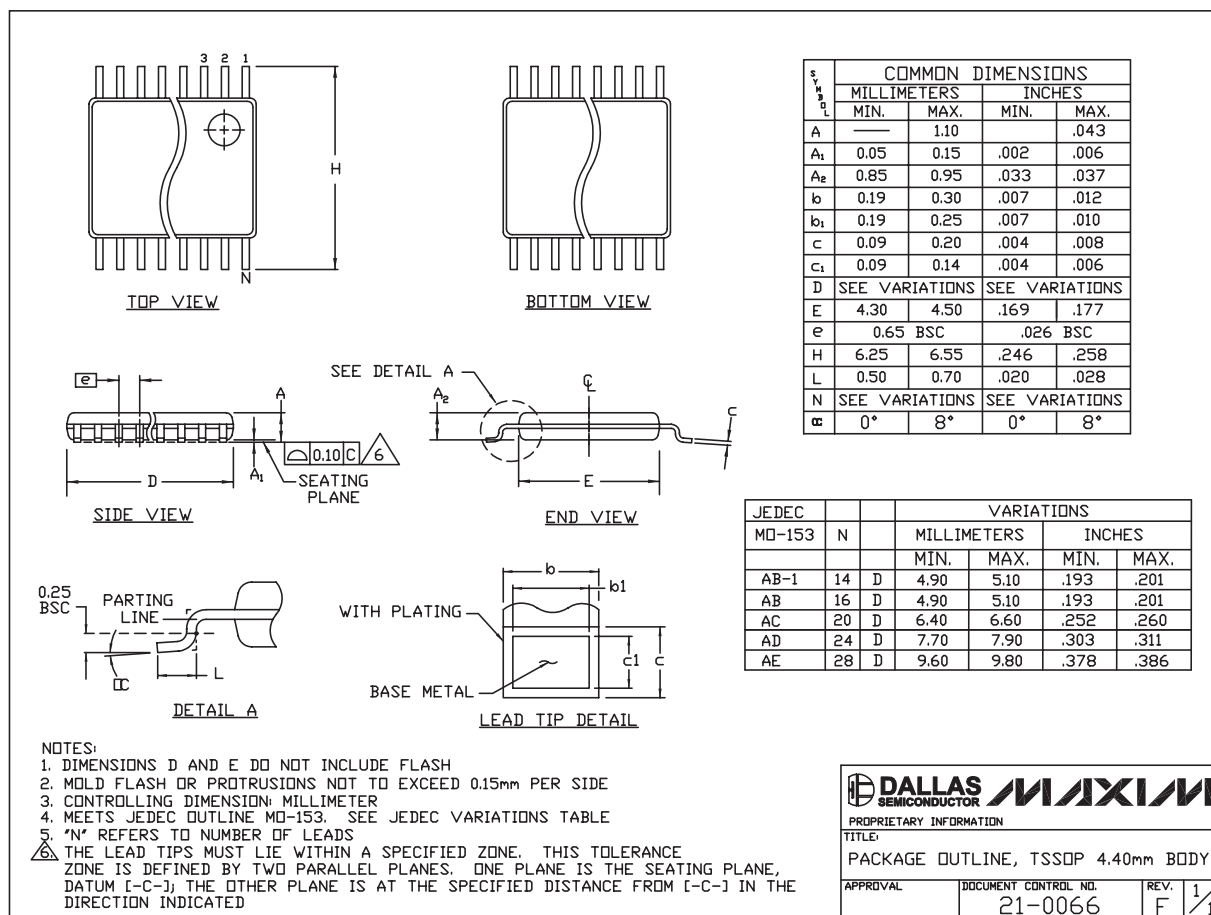

Maxim cannot assume responsibility for use of any circuitry other than circuitry entirely embodied in a Maxim product. No circuit patent licenses are implied. Maxim reserves the right to change the circuitry and specifications without notice at any time.