

# MAXIM

## 350mA, 16.5V Input, Low-Dropout Linear Regulators

### General Description

The MAX1658/MAX1659 linear regulators maximize battery life by combining ultra-low supply currents and low dropout voltages. They feature Dual Mode™ operation, which presets the output to 3.3V (MAX1658) or 5V (MAX1659), or permits it to be adjusted between 1.25V and 16V. The regulator supplies up to 350mA, with a typical dropout of 650mV for the MAX1658 and 490mV for the MAX1659. With their P-channel MOSFET pass transistor, these devices maintain a low quiescent current from zero output current to the full 350mA, even in dropout. They support input voltages ranging from 2.7V to 16.5V.

The MAX1658/MAX1659 feature a 1µA shutdown mode, reverse battery protection, short-circuit protection, and thermal shutdown. They are available in a special high-power (1.2W), 8-pin SO package designed specifically for compact applications.

### Applications

Digital Cordless Phones  
PCS Phones  
Cellular Phones  
PCMCIA Cards  
Modems  
Hand-Held Instruments  
Palmtop Computers  
Electronic Planners

### Typical Operating Circuit

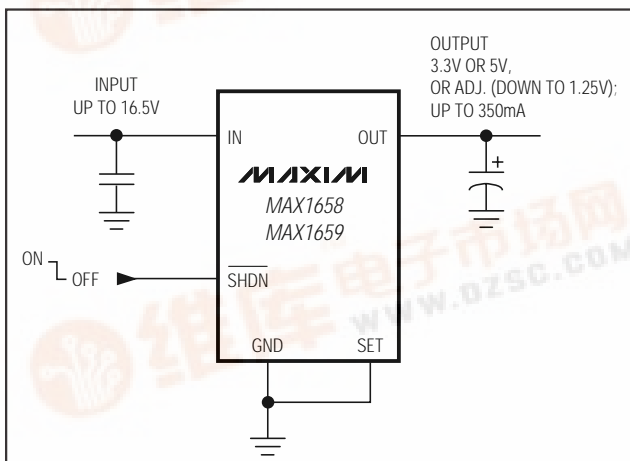

### Features

- ◆ Wide Input Voltage Range: 2.7V to 16.5V
- ◆ Low, 490mV Dropout at 350mA Output Current (MAX1659)
- ◆ 30µA Supply Current
- ◆ 1µA Max Shutdown Current
- ◆ High-Power (1.2W) 8-Pin SO Package
- ◆ Dual Mode Operation Output:
  - Fixed 3.3V (MAX1658)
  - Fixed 5.0V (MAX1659)
  - or Adjustable (1.25V to 16V)
- ◆ Thermal Overload Protection
- ◆ Current-Limit Protection
- ◆ Reverse Battery Protection

### Ordering Information

PART	TEMP. RANGE	PIN-PACKAGE
MAX1658C/D	0°C to +70°C	Dice*
MAX1658ESA	-40°C to +85°C	8 SO
MAX1659C/D	0°C to +70°C	Dice*
MAX1659ESA	-40°C to +85°C	8 SO

\*Dice are tested at  $T_A = +25^\circ\text{C}$ , DC parameters only.

### Pin Configuration

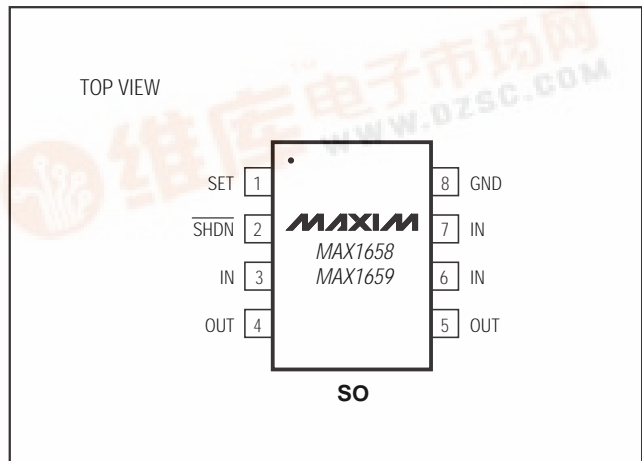

MAX1658/MAX1659

Dual Mode is a trademark of Maxim Integrated Products.

# 350mA, 16.5V Input, Low-Dropout Linear Regulators

## ABSOLUTE MAXIMUM RATINGS

IN to GND	-17V to +17V
Continuous Output Current	500mA
Output Short-Circuit Duration	Infinite
SET, SHDN to GND	-17V to +17V
OUT to GND	-0.3V to (VIN + 0.3V)
Continuous Power Dissipation (Note 1)	
SO (derate 14.5mW/°C above +70°C)	1.2W

Operating Temperature Range	
MAX1658ESA/MAX1659ESA	-40°C to +85°C
Junction Temperature	+150°C
Storage Temperature Range	-65°C to +160°C
Lead Temperature Range (soldering, 10sec)	+300°C

**Note 1:** See *Operating Region and Power Dissipation* section.

Stresses beyond those listed under "Absolute Maximum Ratings" may cause permanent damage to the device. These are stress ratings only, and functional operation of the device at these or any other conditions beyond those indicated in the operational sections of the specifications is not implied. Exposure to absolute maximum rating conditions for extended periods may affect device reliability.

## ELECTRICAL CHARACTERISTICS

(VIN = 5V (MAX1658), VIN = 6V (MAX1659); COU = 10µF; SHDN = IN; TA = TMIN to TMAX; unless otherwise noted. Typical values are at TA = +25°C.) (Note 2)

PARAMETER	SYMBOL	CONDITIONS	MIN	TYP	MAX	UNITS	
Input Voltage Range	VIN	SET = OUT	2.7		16.5	V	
Output Voltage	VOUT	SET = GND, 0mA < ILOAD < 350mA		3.20	3.30	3.40	V
			MAX1658, 5V ≤ VIN ≤ 16.5V				
			4.85	5.00	5.15		
Regulated Output Voltage Range		(Note 3)	1.25		16	V	
Maximum Output Current	IOUT(MAX)		350			mA	
Current Limit	ILIM			900		mA	
Supply Current	IQ			30	60	µA	
Dropout Voltage (Note 4)	ΔVDO	IOUT = 1mA		2		mV	
		IOUT = 350mA	MAX1658	650	1500		
			MAX1659	490	875		
Line Regulation	ΔVLNR	MAX1658, VIN = 5V to 16.5V		0.03		%V	
		MAX1659, VIN = 6V to 16.5V		0.05			
Load Regulation	ΔVLDR	IOUT = 0mA to 350mA		0.003		%/mA	
Startup Overshoot	VOSH			0		%VOUT	
Output Noise	en	10Hz to 100kHz		2.5		mVp-p	
<b>SHUTDOWN</b>							
Logic-Low Input	VINLSHDN	2.7V ≤ VIN ≤ 16.5V			0.4	V	
Logic-High Input Threshold	VINHSHDN	2.7V ≤ VIN ≤ 16.5V	2.0			V	
Shutdown Input Bias Current	ISHDN	SHDN = GND or SHDN = IN		0.1		µA	
Shutdown Supply Current	IQSHDN	SHDN ≤ 0.4V		0.1	1	µA	
Shutdown Exit Time	tSTART	VOUT = 5.0V		120		µs	

# 350mA, 16.5V Input, Low-Dropout Linear Regulators

MAX1658/MAX1659

## ELECTRICAL CHARACTERISTICS (continued)

( $V_{IN} = 5V$  (MAX1658),  $V_{IN} = 6V$  (MAX1659);  $C_{OUT} = 10\mu F$ ;  $\overline{SHDN} = IN$ ;  $T_A = T_{MIN}$  to  $T_{MAX}$ ; unless otherwise noted. Typical values are at  $T_A = +25^\circ C$ .) (Note 2)

PARAMETER	SYMBOL	CONDITIONS	MIN	TYP	MAX	UNITS
<b>SET INPUT</b>						
SET Reference Voltage	$V_{SET}$	$I_{OUT} = 10\mu A$ (Note 3)	1.174	1.210	1.246	V
SET Input Leakage Current	$I_{SET}$	$T_A = +25^\circ C$ (Note 3)		0.01	0.025	$\mu A$
		$T_A = +85^\circ C$ (Note 3)		0.1		
<b>THERMAL PROTECTION</b>						
Thermal Shutdown Temperature	$T_{SD}$			165		$^\circ C$
Thermal Shutdown Hysteresis	$\Delta T_{SD}$			10		$^\circ C$

**Note 2:** Specifications to  $-40^\circ C$  are guaranteed by design, not production tested.

**Note 3:** Adjustable configuration only.  $V_{IN} = 16.5V$ .

**Note 4:** The dropout voltage is defined as  $(V_{IN} - V_{OUT})$  when  $V_{OUT}$  is 100mV below the value of  $V_{OUT}$  for  $V_{IN} = V_{OUT} + 2V$ .

## Typical Operating Characteristics

( $V_{IN} = 5V$  (MAX1658),  $V_{IN} = 6V$  (MAX1659);  $\overline{SHDN} = IN$ ;  $SET = GND$ ;  $C_{IN} = 0.1\mu F$ ;  $C_{OUT} = 10\mu F$  tantalum;  $T_A = +25^\circ C$ ; unless otherwise noted.)

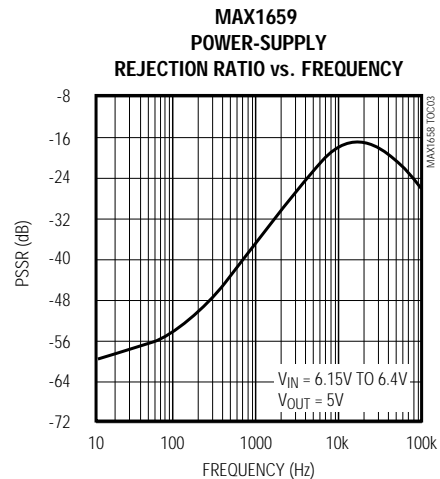
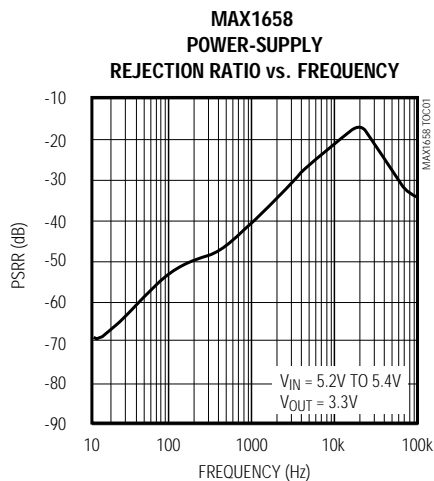

# 350mA, 16.5V Input, Low-Dropout Linear Regulators

## Typical Operating Characteristics (continued)

( $V_{IN} = 5V$  (MAX1658),  $V_{IN} = 6V$  (MAX1659); SHDN = IN; SET = GND;  $C_{IN} = 0.1\mu F$ ;  $C_{OUT} = 10\mu F$  tantalum;  $T_A = +25^\circ C$ ; unless otherwise noted.)

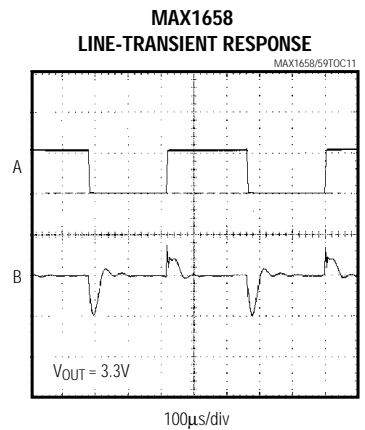
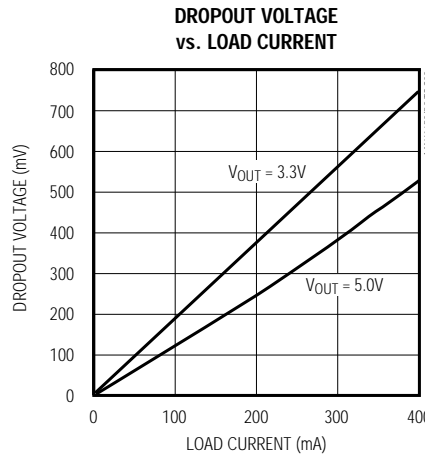
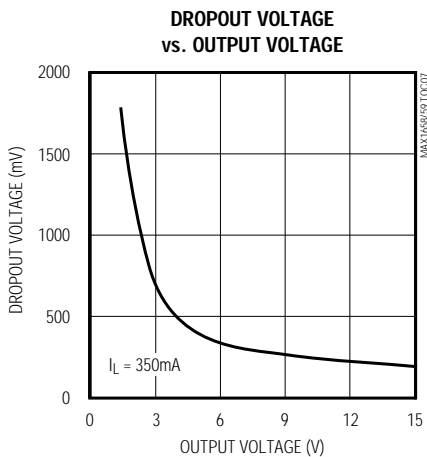
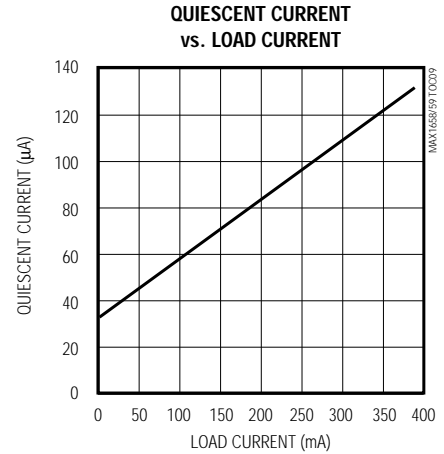
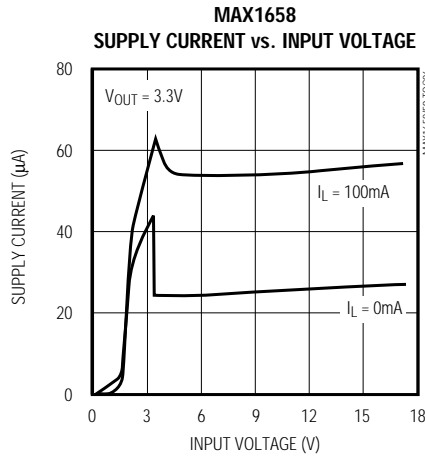
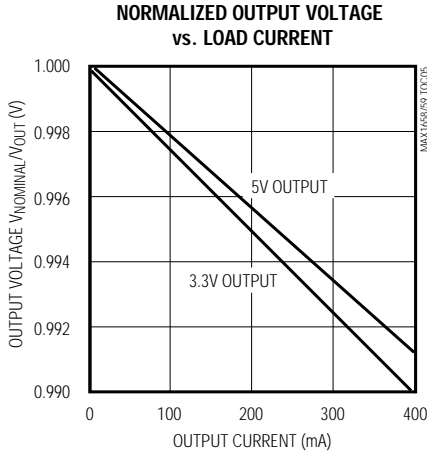

A: INPUT VOLTAGE (1V/div),  $V_{IN} = 6V$  (HIGH),  $V_{IN} = 5V$  (LOW)  
B: OUTPUT VOLTAGE (100mV/div)

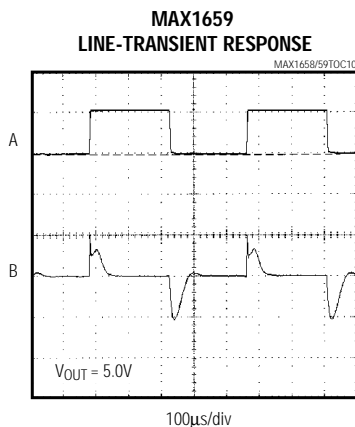

A: INPUT VOLTAGE (1V/div),  $V_{IN} = 7V$  (HIGH),  $V_{IN} = 6V$  (LOW)  
B: OUTPUT VOLTAGE (100mV/div)

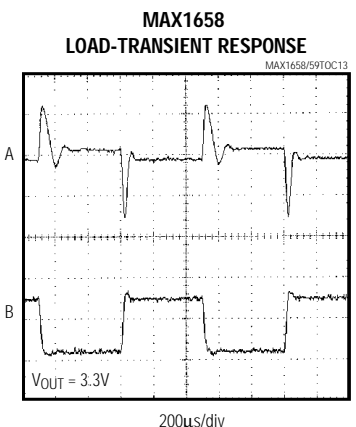

A: OUTPUT VOLTAGE (100mV/div)  
B:  $I_{OUT} = 300mA$  (HIGH),  $I_{OUT} = 40mA$  (LOW)

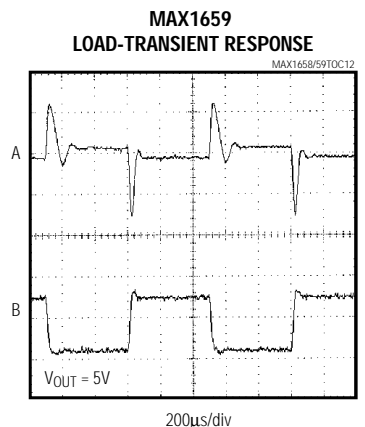

A: OUTPUT VOLTAGE (100mV/div)  
B:  $I_{OUT} = 300mA$  (HIGH),  $I_{OUT} = 40mA$  (LOW)

# 350mA, 16.5V Input, Low-Dropout Linear Regulators

MAX1658/MAX1659

## Typical Operating Characteristics (continued)

( $V_{IN} = 5V$  (MAX1658),  $V_{IN} = 6V$  (MAX1659);  $\overline{SHDN} = \overline{IN}$ ; SET = GND;  $C_{IN} = 0.1\mu F$ ;  $C_{OUT} = 10\mu F$  tantalum;  $T_A = +25^\circ C$ ; unless otherwise noted.)

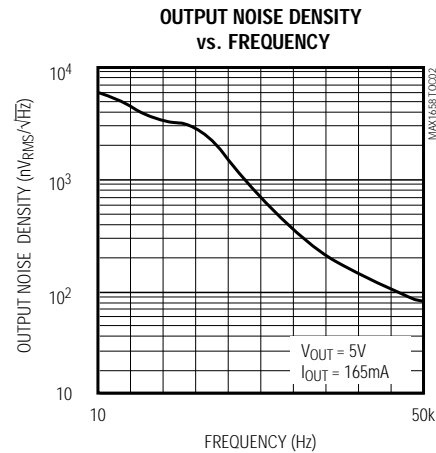
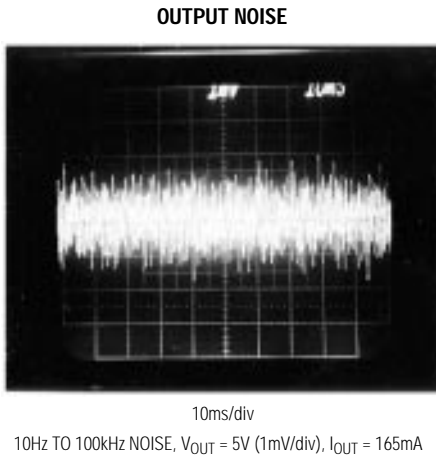
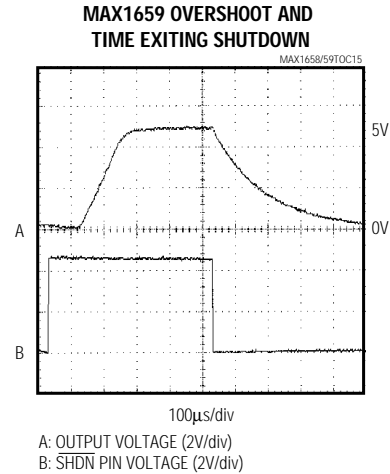
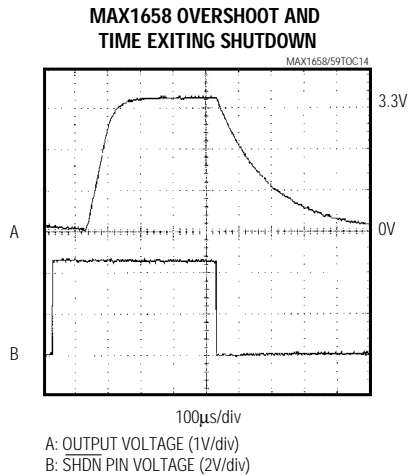

## Pin Description

PIN	NAME	FUNCTION
1	SET	Output Voltage Input. Connecting SET to ground selects the factory-preset 3.3V (MAX1658) or 5V (MAX1659) output voltage. For an adjustable output voltage, connect SET to a resistive voltage divider from OUT to GND.
2	$\overline{SHDN}$	Shutdown Input. When $\overline{SHDN}$ is low, the device turns off and typically draws 0.1µA of supply current.
3, 6, 7	IN	Unregulated Input Supply Voltage, 2.7V to 16.5V input range. The IN pins also serve as heatsinks. Connect to a copper plane to achieve maximum thermal dissipation.
4, 5	OUT	Regulated Output Voltage. Fixed or adjustable from 1.25V to 16V. Sources up to 350mA. For stable operation, bypass with a 10µF, low-ESR (<0.2Ω) capacitor from OUT to GND. For improved load-transient response, use a larger low-ESR capacitor.
8	GND	Ground

## 350mA, 16.5V Input, Low-Dropout Linear Regulators

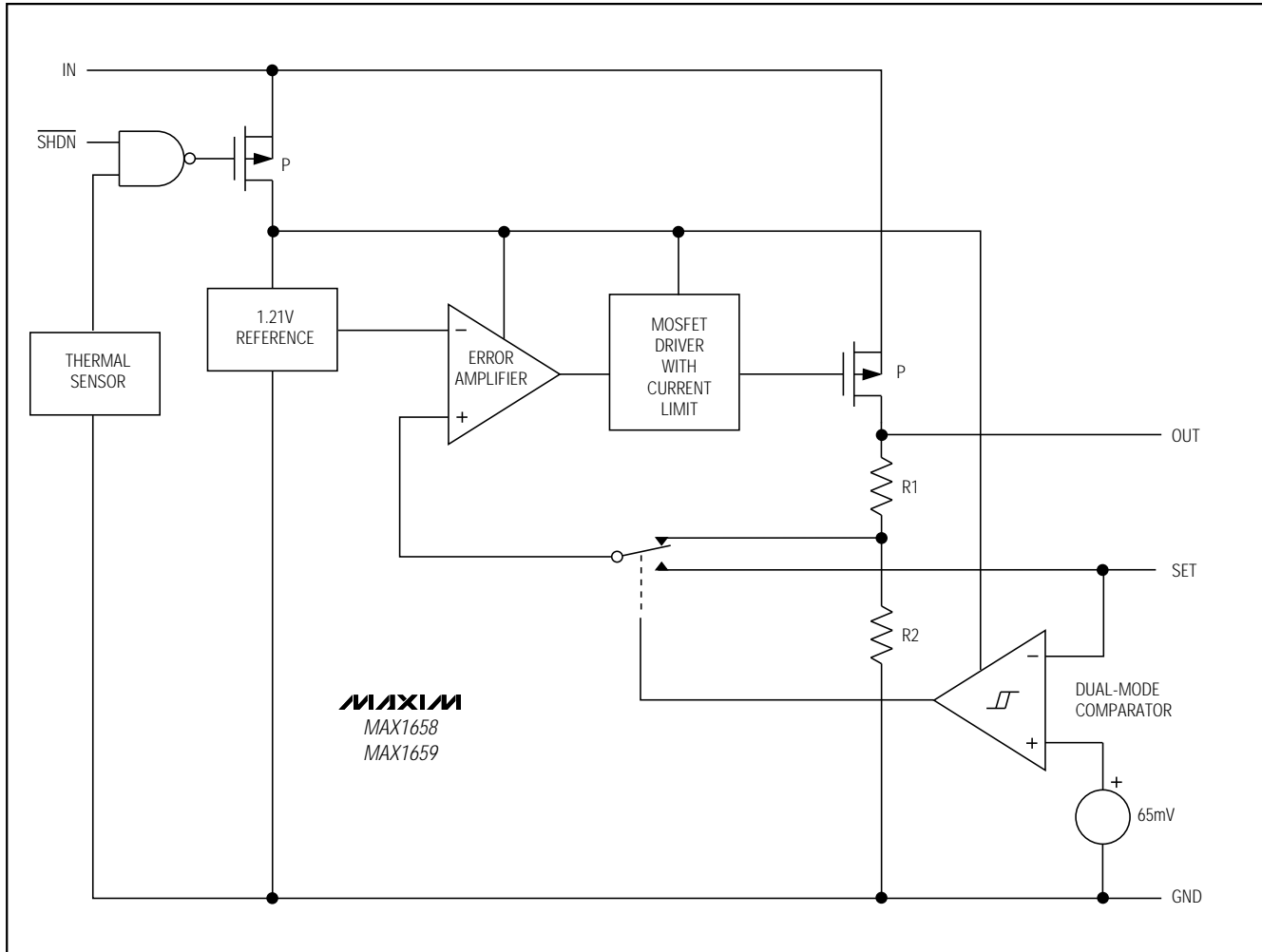

Figure 1. Functional Diagram

### Detailed Description

The MAX1658/MAX1659 are micropower, low-dropout linear regulators featuring Dual Mode™ operation, which allows them to deliver an adjustable (1.25V to 16.5V) or preset (3.3V for the MAX1658, 5V for MAX1659) output. They supply up to 350mA while requiring only 120µA of supply current (typically 30µA with no load). The devices include thermal shutdown circuitry, output current limiting, a P-channel pass transistor, a Dual Mode comparator, and a feedback voltage divider. Figure 1 shows the functional diagram.

The 1.21V reference is connected to the amplifier's inverting input. The error amplifier compares this reference with the selected feedback voltage and amplifies

the difference. The error signal applies the drive to the P-channel pass transistor. If the feedback voltage is lower than the reference voltage, the transistor's gate is pulled lower, increasing output current.

The output voltage is fed back through an internal resistor network or an external user-selected network. The Dual Mode comparator examines the voltage at the SET pin and selects either the internal or external feedback path. If SET is below 65mV, internal feedback sets the MAX1658's output voltage to 3.3V and the MAX1659's to 5V. Otherwise, external feedback is used for an adjustable output between 1.25V and 16.5V. Additional features include internal current limiting, reverse battery protection, thermal-overload protection, and a 1µA shutdown mode.

# 350mA, 16.5V Input, Low-Dropout Linear Regulators

## P-Channel Pass Transistor

The MAX1658/MAX1659 feature an internal P-channel MOSFET pass transistor. Using a MOSFET provides several advantages over similar PNP designs, including lower dropout voltage and extended battery life. Unlike bipolar transistors, MOSFETs reduce quiescent current, because they require no base current, particularly at heavy loads and in dropout. As a result, the MAX1658/MAX1659 operate at a low quiescent current even in dropout.

## Output Voltage Selection

Dual Mode operation allows the MAX1658/MAX1659 to operate at either a preset or a user-adjustable output voltage. The device compares the SET pin voltage with an internal 65mV reference. If the voltage is lower than 65mV (typically achieved by grounding SET), the device switches to an internal resistor-divider feedback network that sets the output voltage. The MAX1658's preset output voltage is 3.3V and the MAX1659's is 5V (Figure 2).

If the SET pin is not below 65mV, the device switches to external feedback and SET becomes a feedback input. The feedback network can be configured to produce an output between 16V and the voltage reference (nominally 1.21V). Under regulation, the feedback mechanism adjusts the error signal such that the voltage at the SET pin equals the reference voltage. Therefore, to achieve the minimum output, connect SET directly to OUT. For other voltages, a resistive voltage-divider network is necessary. Figure 3 shows the topol-

ogy of a typical circuit operating in adjustable mode. The output voltage is set by the following equation:

$$V_{OUT} = V_{SET} \left( 1 + \frac{R1}{R2} \right)$$

where  $V_{SET} = 1.21V$ . Solving for R1 yields:

$$R1 = R2 \left( \frac{V_{OUT}}{V_{SET}} - 1 \right)$$

The input leakage current of the SET input is less than 25nA. This allows the use of large resistors in the feedback network to minimize output current loss without compromising accuracy. R2 can be as high as 500kΩ in most applications.

## Shutdown

A logic low on the  $\overline{SHDN}$  pin places the MAX1658/MAX1659 in shutdown. This mode deactivates all functions, including the pass transistor. The device consumes less than 1μA of supply current in shutdown, and its output becomes high impedance. The MAX1658/MAX1659 exit shutdown in 100μs.

## Output Current Limit

The MAX1658/MAX1659 include current-limiting circuitry that monitors and controls the pass transistor and limits output current to around 900mA. The output can be shorted to ground indefinitely without damaging the device.

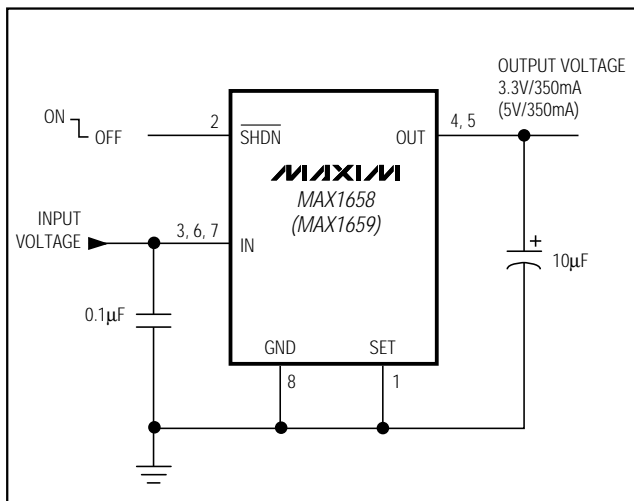

Figure 2. Preset Output Configuration

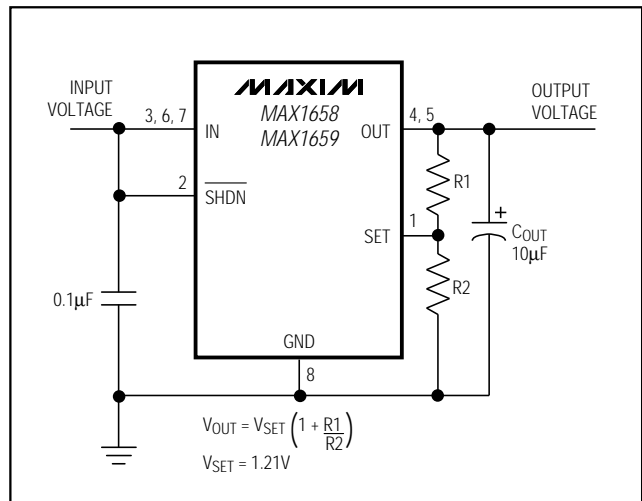

Figure 3. Adjustable Output Configuration Using External Feedback Resistors

## 350mA, 16.5V Input, Low-Dropout Linear Regulators

### Thermal-Overload Protection

Thermal-overload protection limits total power dissipation in the MAX1658/MAX1659. When the junction temperature exceeds  $T_J = +165^\circ\text{C}$ , the pass transistor deactivates, allowing the IC to cool. Once it has cooled by  $10^\circ\text{C}$ , the control logic will enable operation. Under thermal overload, the output of the device will pulse as the die heats up and then cools to operational levels. Prolonged operation under these conditions is not recommended.

### Operating Region and Power Dissipation

Maximum power dissipation of the MAX1658/MAX1659 depends on the thermal resistance of the package and circuit board, the temperature difference between the die and ambient air, and the rate of air flow. The power dissipation by the device is  $P = I_{\text{OUT}}(V_{\text{IN}} - V_{\text{OUT}})$ . The maximum power dissipation is:

$$P_{\text{MAX}} = \left( \frac{(T_J - T_A)}{(\theta_{\text{JB}} + \theta_{\text{BA}})} \right)$$

where  $(T_J - T_A)$  is the temperature difference between MAX1658/MAX1659 die junction and the surrounding air,  $\theta_{\text{JB}}$  is the thermal resistance of the package, and  $\theta_{\text{BA}}$  is the thermal resistance through the printed circuit board, copper traces, and other materials to the surrounding air. The 8-pin SO package for the MAX1658/MAX1659 features a special lead frame with a lower thermal resistance and higher allowable power dissipation than a standard SO-8. The thermal resistance of this package is  $\theta_{\text{JB}} = 69^\circ\text{C/W}$ , compared with  $\theta_{\text{JB}} = 170^\circ\text{C/W}$  for an SO-8.

The IN pins of the MAX1658/MAX1659 package perform the dual function of providing an electrical connection to IN and channeling heat away. Connect all IN pins to the input voltage using a large pad or power plane on the surface. Where this is impossible, connect to a copper plane on an adjacent layer. The pad should meet the dimensions specified in Figure 4.

Figure 4 assumes the IC is soldered directly to the pad, has a  $+125^\circ\text{C}$  maximum junction temperature and a  $+25^\circ\text{C}$  ambient air temperature, and has no other heat sources. Use larger pad sizes for lower junction temperatures, higher ambient temperatures, or conditions where the IC is not soldered directly to a heat-sinking IN pad.

The MAX1658/MAX1659 can regulate currents up to 350mA and operate with input voltages up to 16.5V, but not simultaneously. High output currents can only be sustained when input-output differential voltage is low,

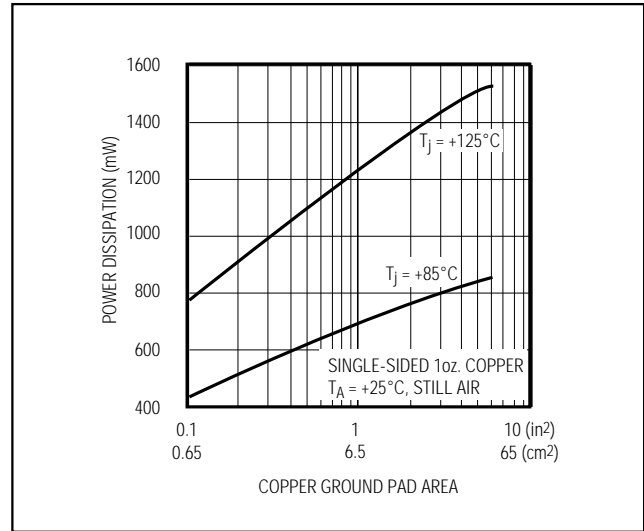

Figure 4. Typical Maximum Power Dissipation vs. Ground Pad Area

as shown in the following equation. Maximum power dissipation depends on packaging, board layout, temperature, and air flow. The maximum output current is:

$$I_{\text{OUT(MAX)}} = \frac{P_{\text{MAX}} \times (125^\circ\text{C} - T_A)}{(V_{\text{IN}} - V_{\text{OUT}}) \times 100^\circ\text{C}}$$

where  $P_{\text{MAX}}$  is derived from the  $T_J = 125^\circ\text{C}$  curve of Figure 4.

### Reverse Battery Protection

The MAX1658/MAX1659 feature reverse battery protection. Under normal operation, a P-channel MOSFET connects the substrate of the device to IN. When the input voltage falls below ground (implying reverse battery conditions), the P-channel switch turns off and disconnects the substrate from IN, disabling the device. The maximum reverse battery voltage allowed is  $-17\text{V}$ . SHDN also withstands reverse battery conditions and can be connected directly to IN with no loss of protection.

Polarized input bypass capacitors will be damaged under reverse battery conditions. To ensure circuit reliability, use a non-polarized capacitor at the input.

The MAX1658/MAX1659 do not provide reverse current protection. If  $V_{\text{OUT}}$  is greater than  $V_{\text{IN}}$  by more than 300mV, reverse current will flow. Reverse current protection can be added by connecting a Schottky diode in series with IN.



# 350mA, 16.5V Input, Low-Dropout Linear Regulators

MAX1658/MAX1659

## Applications Information

### Output Capacitor Selection and Stability

To maintain stability, connect a  $\geq 10\mu\text{F}$  capacitor with less than  $200\text{m}\Omega$  equivalent series resistance (ESR) from OUT to GND. Larger output capacitors improve load-transient response. Currents lower than 350mA make the use of smaller output capacitors possible. Table 1 shows the maximum output current typically achieved using various output capacitors. Output voltages higher than 3.3V require less output capacitance to remain stable.

**Table 1. Typical Load Current Capabilities**

OUTPUT CAPACITOR	LOAD CURRENT RANGE
2.2 $\mu\text{F}$ tantalum	0mA to 120mA
4.7 $\mu\text{F}$ tantalum	0mA to 250mA
10 $\mu\text{F}$ tantalum	0mA to 350mA

### Input Bypass Capacitor

The use of a 0.1 $\mu\text{F}$  to 10 $\mu\text{F}$  input bypass capacitor is recommended. Larger capacitors provide better supply-noise rejection and line-transient response, as well as improved performance when the supply has a high AC impedance. Polarized input bypass capacitors will be damaged under reverse battery conditions. If reverse input voltages are expected, use a non-polarized capacitor at the input.

### Noise and PSRR

The MAX1658/MAX1659 exhibit 2.5mVp-p of noise during normal operation. This noise level is negligible in most applications.

The MAX1658/MAX1659 are designed to maintain excellent power-supply rejection (55dB) at 50Hz/60Hz (or 50dB at 120Hz). These regulators are ideal for wall-cube applications that may contain significant ripple. Larger input and output capacitors will further improve the circuit's AC response. See the Power-Supply Rejection Ratio vs. Frequency graphs in the *Typical Operating Characteristics*.

## Chip Information

TRANSISTOR COUNT: 207

# 350mA, 16.5V Input, Low-Dropout Linear Regulators

## Package Information

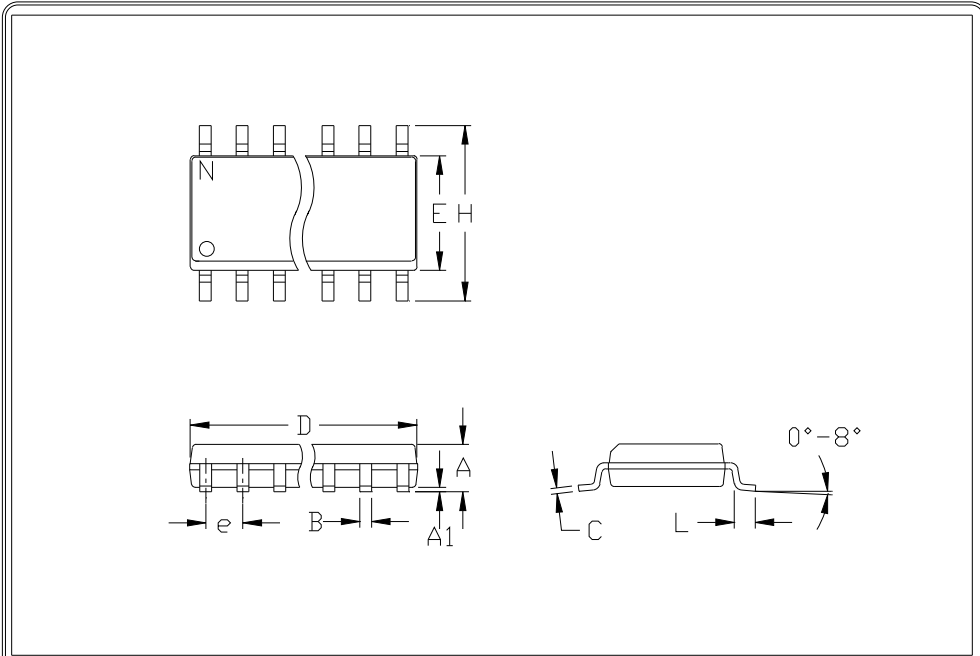

	INCHES		MILLIMETERS	
	MIN	MAX	MIN	MAX
A	0.053	0.069	1.35	1.75
A1	0.004	0.010	0.10	0.25
B	0.014	0.019	0.35	0.49
C	0.007	0.010	0.19	0.25
e	0.050		1.27	
E	0.150	0.157	3.80	4.00
H	0.228	0.244	5.80	6.20
h	0.010	0.020	0.25	0.50
L	0.016	0.050	0.40	1.27

	INCHES		MILLIMETERS		N	MS012
	MIN	MAX	MIN	MAX		
D	0.189	0.197	4.80	5.00	8	A
D	0.337	0.344	8.55	8.75	14	B
D	0.386	0.394	9.80	10.00	16	C

- NOTES:
1. D&E DO NOT INCLUDE MOLD FLASH
  2. MOLD FLASH OR PROTRUSIONS NOT TO EXCEED .15mm (.006")
  3. LEADS TO BE COPLANAR WITHIN .102mm (.004")
  4. CONTROLLING DIMENSION: MILLIMETER
  5. MEETS JEDEC MS012-XX AS SHOWN IN ABOVE TABLE
  6. N = NUMBER OF PINS

 <small>120 SAN GABRIEL DR. SUNNYVALE CA 94086 FAX (408) 737-7154</small> <small>PROPRIETARY INFORMATION</small>	PACKAGE FAMILY OUTLINE: SOIC .150"		21-0041 A

*350mA, 16.5V Input,  
Low-Dropout Linear Regulators*

**NOTES**

MAX1658/MAX1659

# 350mA, 16.5V Input, Low-Dropout Linear Regulators

## NOTES

*Maxim cannot assume responsibility for use of any circuitry other than circuitry entirely embodied in a Maxim product. No circuit patent licenses are implied. Maxim reserves the right to change the circuitry and specifications without notice at any time.*

**12** \_\_\_\_\_ Maxim Integrated Products, 120 San Gabriel Drive, Sunnyvale, CA 94086 408-737-7600