



LT1211/LT1212

14MHz, 7V/μs, Single Supply Dual and Quad Precision Op Amps

FEATURES

- Slew Rate 7V/μs Typ
- Gain-Bandwidth Product 14MHz Typ
- Fast Settling to 0.01%
 - 2V Step to 200μV 900ns Typ
 - 10V Step to 1mV 2.2μs Typ
- Excellent DC Precision in All Packages
 - Input Offset Voltage 275μV Max
 - Input Offset Voltage Drift 6μV/°C Max
 - Input Offset Current 30nA Max
 - Input Bias Current 125nA Max
 - Open-Loop Gain 1200V/mV Min
- Single Supply Operation
 - Input Voltage Range Includes Ground
 - Output Swings to Ground While Sinking Current
- Low Input Noise Voltage 12nV/√Hz Typ
- Low Input Noise Current 0.2pA/√Hz Typ
- Specified on 3.3V, 5V and ±15V
- Large Output Drive Current 20mA Min
- Low Supply Current per Amplifier 1.8mA Max
- Dual in 8-Pin DIP and SO8
- Quad in 14-Pin DIP and NARROW SO16

Note: For applications requiring higher slew rate, see the LT1213/LT1214 and LT1215/LT1216 data sheets.

DESCRIPTION

The LT1211 is a dual, single supply precision op amp with a 14MHz gain-bandwidth product and a 7V/μs slew rate. The LT1212 is a quad version of the same amplifier. The DC precision of the LT1211/LT1212 eliminates trims in most systems while providing high frequency performance not usually found in single supply amplifiers.

The LT1211/LT1212 will operate on any supply greater than 2.5V and less than 36V total. These amplifiers are specified on single 3.3V, single 5V and ±15V supplies, and only require 1.3mA of quiescent supply current per amplifier. The inputs can be driven beyond the supplies without damage or phase reversal of the output. The minimum output drive is 20mA, ideal for driving low impedance loads.

APPLICATIONS

- 2.5V Full-Scale 12-Bit Systems $V_{OS} \leq 0.45LSB$
- 10V Full-Scale 16-Bit Systems $V_{OS} \leq 1.8LSB$
- Active Filters
- Photo Diode Amplifiers
- DAC Current-to-Voltage Amplifiers
- Battery-Powered Systems

TYPICAL APPLICATION

Input Bias Current Cancellation

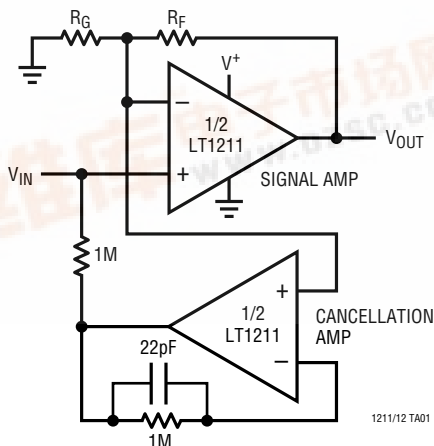

Input Current vs Input Voltage

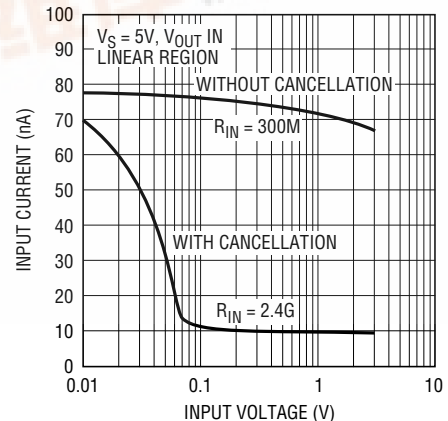

LT1211/LT1212

ABSOLUTE MAXIMUM RATINGS

Total Supply Voltage (V^+ to V^-) 36V
 Input Current $\pm 15\text{mA}$
 Output Short-Circuit Duration (Note 1) Continuous
 Operating Temperature Range
 LT1211C/LT1212C -40°C to 85°C
 LT1211M -55°C to 125°C

Storage Temperature Range -65°C to 150°C
 Junction Temperature (Note 2)
 Plastic Package (N8, S8, N, S) 150°C
 Ceramic Package (J8) 175°C
 Lead Temperature (Soldering, 10 sec) 300°C

PACKAGE/ORDER INFORMATION

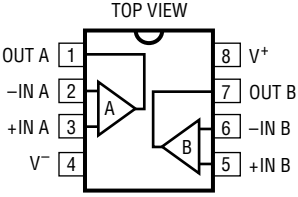
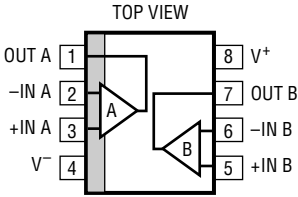
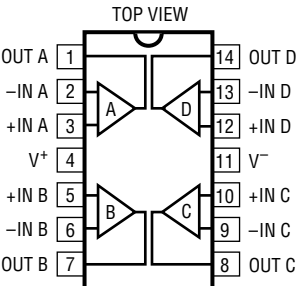
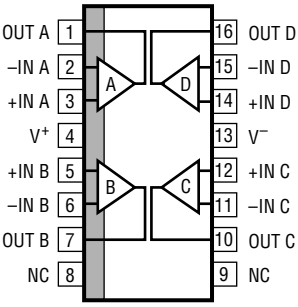
 <p>J8 PACKAGE 8-LEAD CERAMIC DIP</p> <p>N8 PACKAGE 8-LEAD PLASTIC DIP</p> <p>$T_{JMAX} = 175^\circ\text{C}$, $\theta_{JA} = 100^\circ\text{C/W}$ (J) $T_{JMAX} = 150^\circ\text{C}$, $\theta_{JA} = 100^\circ\text{C/W}$ (N)</p>	<p>ORDER PART NUMBER</p> <p>LT1211CN8 LT1211ACN8 LT1211MJ8 LT1211AMJ8</p>	 <p>S8 PACKAGE 8-LEAD PLASTIC SOIC</p> <p>$T_{JMAX} = 150^\circ\text{C}$, $\theta_{JA} = 150^\circ\text{C/W}$</p>	<p>ORDER PART NUMBER</p> <p>LT1211CS8</p> <p>S8 PART MARKING</p> <p>1211</p>
 <p>N PACKAGE 14-LEAD PLASTIC DIP</p> <p>$T_{JMAX} = 150^\circ\text{C}$, $\theta_{JA} = 70^\circ\text{C/W}$</p>	<p>ORDER PART NUMBER</p> <p>LT1212CN</p>	 <p>S PACKAGE 16-LEAD PLASTIC SOIC</p> <p>$T_{JMAX} = 150^\circ\text{C}$, $\theta_{JA} = 100^\circ\text{C/W}$</p>	<p>ORDER PART NUMBER</p> <p>LT1212CS</p>

AVAILABLE OPTIONS

NUMBER OF OP AMPS	T_A RANGE	MAX V_{OS} (25°C)	MAX TC V_{OS} ($\Delta V_{OS}/\Delta T$)	PACKAGE		
				CERAMIC (J)	PLASTIC DIP (N)	SURFACE MOUNT (S)
Two (Dual)	-40°C to 85°C	150 μV	1.5 $\mu\text{V}/^\circ\text{C}$		LT1211ACN8	
		275 μV	3 $\mu\text{V}/^\circ\text{C}$		LT1211CN8	
		275 μV	6 $\mu\text{V}/^\circ\text{C}$			LT1211CS8
Two (Dual)	-55°C to 125°C	150 μV	1.5 $\mu\text{V}/^\circ\text{C}$	LT1211AMJ8		
		275 μV	3 $\mu\text{V}/^\circ\text{C}$	LT1211MJ8		
Four (Quad)	-40°C to 85°C	275 μV	6 $\mu\text{V}/^\circ\text{C}$		LT1212CN	LT1212CS

5V ELECTRICAL CHARACTERISTICS

$V_S = 5V$, $V_{CM} = 0.5V$, $V_{OUT} = 0.5V$, $T_A = 25^\circ C$, unless otherwise noted.

SYMBOL	PARAMETER	CONDITIONS	LT1211AC LT1211AM			LT1211C/LT1211M LT1212C			UNITS
			MIN	TYP	MAX	MIN	TYP	MAX	
V_{OS}	Input Offset Voltage			75	150		100	275	μV
$\frac{\Delta V_{OS}}{\Delta Time}$	Long-Term Input Offset Voltage Stability			0.5			0.6		$\mu V/Mo$
I_{OS}	Input Offset Current			5	20		5	30	nA
I_B	Input Bias Current			50	100		60	125	nA
	Input Noise Voltage	0.1Hz to 10Hz		250			250		nV _{P-P}
e_n	Input Noise Voltage Density	$f_0 = 10Hz$ $f_0 = 1000Hz$		12.5 12.0			12.5 12.0		nV/ \sqrt{Hz} nV/ \sqrt{Hz}
i_n	Input Noise Current Density	$f_0 = 10Hz$ $f_0 = 1000Hz$		0.9 0.2			0.9 0.2		pA/ \sqrt{Hz} pA/ \sqrt{Hz}
	Input Resistance (Note 3)	Differential Mode Common Mode	10	40 500		10	40 500		M Ω M Ω
	Input Capacitance	$f = 1MHz$		10			10		pF
	Input Voltage Range		3.5 0	3.8 -0.3		3.5 0	3.8 -0.3		V V
CMRR	Common-Mode Rejection Ratio	$V_{CM} = 0V$ to 3.5V	90	105		86	102		dB
PSRR	Power Supply Rejection Ratio	$V_S = 2.5V$ to 12.5V	90	115		87	110		dB
A_{VOL}	Large-Signal Voltage Gain	$V_0 = 0.05V$ to 3.7V, $R_L = 500\Omega$	250	560		250	560		V/mV
	Maximum Output Voltage Swing (Note 4)	Output High, No Load	4.30	4.40		4.30	4.40		V
		Output High, $I_{SOURCE} = 1mA$	4.20	4.30		4.20	4.30		V
		Output High, $I_{SOURCE} = 15mA$	3.85	4.00		3.85	4.00		V
		Output Low, No Load		0.003	0.006		0.003	0.006	V
		Output Low, $I_{SINK} = 1mA$		0.047	0.065		0.047	0.065	V
		Output Low, $I_{SINK} = 15mA$		0.362	0.500		0.362	0.500	V
I_O	Maximum Output Current	(Note 9)	± 20	± 50		± 20	± 50		mA
SR	Slew Rate	$A_V = -2$		4			4		V/ μs
GBW	Gain-Bandwidth Product	$f = 100kHz$		13			13		MHz
I_S	Supply Current per Amplifier		0.9	1.3	1.8	0.9	1.3	1.8	mA
	Minimum Supply Voltage	Single Supply		2.2	2.5		2.2	2.5	V
	Full Power Bandwidth	$A_V = 1$, $V_0 = 2.5V_{P-P}$		300			300		kHz
t_r , t_f	Rise Time, Fall Time	$A_V = 1$, 10% to 90%, $V_0 = 100mV$		45			45		ns
OS	Overshoot	$A_V = 1$, $V_0 = 100mV$		25			25		%
t_{PD}	Propagation Delay	$A_V = 1$, $V_0 = 100mV$		36			36		ns
t_S	Settling Time	0.01%, $A_V = 1$, $\Delta V_0 = 2V$		900			900		ns
	Open-Loop Output Resistance	$I_0 = 0mA$, $f = 5MHz$		75			75		Ω
THD	Total Harmonic Distortion	$A_V = 1$, $V_0 = 1V_{RMS}$, 20Hz to 20kHz		0.001			0.001		%

LT1211/LT1212

5V ELECTRICAL CHARACTERISTICS

$V_S = 5V$, $V_{CM} = 0.5V$, $V_{OUT} = 0.5V$, $0^\circ C \leq T_A \leq 70^\circ C$, unless otherwise noted.

SYMBOL	PARAMETER	CONDITIONS	LT1211AC			LT1211C/LT1212C			UNITS
			MIN	TYP	MAX	MIN	TYP	MAX	
V_{OS}	Input Offset Voltage			100	175		150	375	μV
$\frac{\Delta V_{OS}}{\Delta T}$	Input Offset Voltage Drift (Note 3)	8-Pin DIP Package 14-Pin DIP, SOIC Package		0.7	1.5		1	3	$\mu V/^\circ C$
I_{OS}	Input Offset Current			5	25		10	35	nA
I_B	Input Bias Current			60	110		70	135	nA
	Input Voltage Range		3.4	3.5		3.4	3.5		V
			0.1	-0.1		0.1	-0.1		V
CMRR	Common-Mode Rejection Ratio	$V_{CM} = 0.1V$ to $3.4V$	89	105		85	102		dB
PSRR	Power Supply Rejection Ratio	$V_S = 2.5V$ to $12.5V$	89	114		86	110		dB
A_{VOL}	Large-Signal Voltage Gain	$V_O = 0.05V$ to $3.7V$, $R_L = 500\Omega$	150	430		150	430		V/mV
	Maximum Output Voltage Swing (Note 4)	Output High, No Load	4.20	4.33		4.20	4.33		V
		Output High, $I_{SOURCE} = 1mA$	4.10	4.23		4.10	4.23		V
		Output High, $I_{SOURCE} = 10mA$	3.90	4.03		3.90	4.03		V
		Output Low, No Load		0.004	0.007		0.004	0.007	V
		Output Low, $I_{SINK} = 1mA$		0.052	0.070		0.052	0.070	V
		Output Low, $I_{SINK} = 10mA$		0.290	0.400		0.290	0.400	V
I_S	Supply Current per Amplifier		0.8	1.4	2.1	0.8	1.4	2.1	mA

$V_S = 5V$, $V_{CM} = 0.5V$, $V_{OUT} = 0.5V$, $-40^\circ C \leq T_A \leq 85^\circ C$, unless otherwise noted. (Note 5)

SYMBOL	PARAMETER	CONDITIONS	LT1211AC			LT1211C/LT1212C			UNITS
			MIN	TYP	MAX	MIN	TYP	MAX	
V_{OS}	Input Offset Voltage			120	200		175	500	μV
$\frac{\Delta V_{OS}}{\Delta T}$	Input Offset Voltage Drift (Note 3)	8-Pin DIP Package 14-Pin DIP, SOIC Package		0.7	1.5		1	3	$\mu V/^\circ C$
I_{OS}	Input Offset Current			10	30		20	50	nA
I_B	Input Bias Current			70	120		80	145	nA
	Input Voltage Range		3.1	3.2		3.1	3.2		V
			0.2	0		0.2	0		V
CMRR	Common-Mode Rejection Ratio	$V_{CM} = 0.2V$ to $3.1V$	88	104		84	101		dB
PSRR	Power Supply Rejection Ratio	$V_S = 2.5V$ to $12.5V$	88	113		85	109		dB
A_{VOL}	Large-Signal Voltage Gain	$V_O = 0.05V$ to $3.7V$, $R_L = 500\Omega$	100	390		100	390		V/mV
	Maximum Output Voltage Swing (Note 4)	Output High, No Load	4.15	4.25		4.15	4.25		V
		Output High, $I_{SOURCE} = 1mA$	4.00	4.16		4.00	4.16		V
		Output High, $I_{SOURCE} = 10mA$	3.80	3.96		3.80	3.96		V
		Output Low, No Load		0.005	0.008		0.005	0.008	V
		Output Low, $I_{SINK} = 1mA$		0.053	0.075		0.053	0.075	V
		Output Low, $I_{SINK} = 10mA$		0.300	0.420		0.300	0.420	V
I_S	Supply Current per Amplifier		0.7	1.5	2.2	0.7	1.5	2.2	mA

5V ELECTRICAL CHARACTERISTICS

$V_S = 5V$, $V_{CM} = 0.5V$, $V_{OUT} = 0.5V$, $-55^\circ C \leq T_A \leq 125^\circ C$, unless otherwise noted.

SYMBOL	PARAMETER	CONDITIONS	LT1211AM			LT1211M			UNITS
			MIN	TYP	MAX	MIN	TYP	MAX	
V_{OS}	Input Offset Voltage			140	250		200	500	μV
$\frac{\Delta V_{OS}}{\Delta T}$	Input Offset Voltage Drift (Note 3)			0.7	1.5		1	3	$\mu V/^\circ C$
I_{OS}	Input Offset Current			15	40		25	75	nA
I_B	Input Bias Current			75	130		85	160	nA
	Input Voltage Range		3.1	3.2		3.1	3.2		V
			0.4	0.2		0.4	0.2		V
CMRR	Common-Mode Rejection Ratio	$V_{CM} = 0.4V$ to $3.1V$	87	104		81	101		dB
PSRR	Power Supply Rejection Ratio	$V_S = 2.5V$ to $12.5V$	87	113		84	109		dB
A_{VOL}	Large-Signal Voltage Gain	$V_O = 0.05V$ to $3.7V$, $R_L = 500\Omega$	100	250		100	250		V/mV
	Maximum Output Voltage Swing (Note 4)	Output High, No Load	4.10	4.20		4.10	4.20		V
		Output High, $I_{SOURCE} = 1mA$	3.95	4.10		3.95	4.10		V
		Output High, $I_{SOURCE} = 10mA$	3.70	3.90		3.70	3.90		V
		Output Low, No Load		0.007	0.010		0.007	0.010	mV
		Output Low, $I_{SINK} = 1mA$		0.060	0.085		0.060	0.085	mV
		Output Low, $I_{SINK} = 10mA$		0.350	0.500		0.350	0.500	mV
I_S	Supply Current per Amplifier		0.5	1.7	2.5	0.5	1.7	2.5	mA

$\pm 15V$ ELECTRICAL CHARACTERISTICS

$V_S = \pm 15V$, $V_{CM} = 0V$, $V_{OUT} = 0V$, $T_A = 25^\circ C$, unless otherwise noted.

SYMBOL	PARAMETER	CONDITIONS	LT1211AC LT1211AM			LT1211C/LT1211M LT1212C			UNITS
			MIN	TYP	MAX	MIN	TYP	MAX	
V_{OS}	Input Offset Voltage			125	400		150	550	μV
I_{OS}	Input Offset Current			5	20		5	30	nA
I_B	Input Bias Current			45	95		50	120	nA
	Input Voltage Range		13.5	13.8		13.5	13.8		V
			-15.0	-15.3		-15.0	-15.3		V
CMRR	Common-Mode Rejection Ratio	$V_{CM} = -15V$ to $13.5V$	90	105		86	102		dB
PSRR	Power Supply Rejection Ratio	$V_S = \pm 2V$ to $\pm 18V$	90	113		87	110		dB
A_{VOL}	Large-Signal Voltage Gain	$V_O = 0V$ to $\pm 10V$, $R_L = 2k$	1200	5000		1200	5000		V/mV
	Maximum Output Voltage Swing	Output High, $I_{SOURCE} = 15mA$	13.8	14.0		13.8	14.0		V
		Output Low, $I_{SINK} = 15mA$	-14.4	-14.6		-14.4	-14.6		V
I_O	Maximum Output Current	(Note 9)	± 20	± 50		± 20	± 50		mA
SR	Slew Rate	$A_V = -2$ (Note 6)	5	7		5	7		V/ μs
GBW	Gain-Bandwidth Product	$f = 100kHz$	8	14		8	14		MHz
I_S	Supply Current per Amplifier		0.9	1.8	2.5	0.9	1.8	2.5	mA
	Channel Separation	$V_O = \pm 10V$, $R_L = 2k$	128	140		128	140		dB
	Minimum Supply Voltage	Equal Split Supplies		± 1.2	± 2.0		± 1.2	± 2.0	V
	Full Power Bandwidth	$A_V = 1$, $V_O = 20V_{P-P}$		60			60		kHz
	Settling Time	0.01%, $A_V = 1$, $\Delta V_O = 10V$		2.2			2.2		μs

LT1211/LT1212

±15V ELECTRICAL CHARACTERISTICS

$V_S = \pm 15V$, $V_{CM} = 0V$, $V_{OUT} = 0V$, $0^\circ C \leq T_A \leq 70^\circ C$, unless otherwise noted.

SYMBOL	PARAMETER	CONDITIONS	LT1211AC			LT1211C/LT1212C			UNITS
			MIN	TYP	MAX	MIN	TYP	MAX	
V_{OS}	Input Offset Voltage			150	425		200	650	μV
$\frac{\Delta V_{OS}}{\Delta T}$	Input Offset Voltage Drift (Note 3)	8-Pin DIP Package 14-Pin DIP, SOIC Package		0.7	1.5		1	3	$\mu V/^\circ C$
I_{OS}	Input Offset Current			10	20		10	35	nA
I_B	Input Bias Current			55	100		60	125	nA
	Input Voltage Range		13.4	13.5		13.4	13.5		V
			-14.9	-15.1		-14.9	-15.1		V
CMRR	Common-Mode Rejection Ratio	$V_{CM} = -14.9V$ to $13.4V$	89	104		85	101		dB
PSRR	Power Supply Rejection Ratio	$V_S = \pm 2V$ to $\pm 18V$	89	112		86	108		dB
A_{VOL}	Large-Signal Voltage Gain	$V_O = 0V$ to $\pm 10V$, $R_L = 2k$	1000	3500		1000	3500		V/mV
	Maximum Output Voltage Swing	Output High, $I_{SOURCE} = 10mA$	13.8	14.0		13.8	14.0		V
		Output Low, $I_{SINK} = 10mA$	-14.5	-14.7		-14.5	-14.7		V
I_S	Supply Current per Amplifier		0.8	2.1	2.9	0.8	2.1	2.9	mA

$V_S = \pm 15V$, $V_{CM} = 0V$, $V_{OUT} = 0V$, $-40^\circ C \leq T_A \leq 85^\circ C$, unless otherwise noted. (Note 5)

SYMBOL	PARAMETER	CONDITIONS	LT1211AC			LT1211C/LT1212C			UNITS
			MIN	TYP	MAX	MIN	TYP	MAX	
V_{OS}	Input Offset Voltage			175	450		250	700	μV
$\frac{\Delta V_{OS}}{\Delta T}$	Input Offset Voltage Drift (Note 3)	8-Pin DIP Package 14-Pin DIP, SOIC Package		0.7	1.5		1	3	$\mu V/^\circ C$
I_{OS}	Input Offset Current			10	25		10	40	nA
I_B	Input Bias Current			55	100		60	130	nA
	Input Voltage Range		13.1	13.2		13.1	13.2		V
			-14.8	-15.0		-14.8	-15.0		V
CMRR	Common-Mode Rejection Ratio	$V_{CM} = -14.8V$ to $13.1V$	88	103		84	100		dB
PSRR	Power Supply Rejection Ratio	$V_S = \pm 2V$ to $\pm 18V$	88	111		85	107		dB
A_{VOL}	Large-Signal Voltage Gain	$V_O = 0V$ to $\pm 10V$, $R_L = 2k$	1000	3000		1000	3000		V/mV
	Maximum Output Voltage Swing	Output High, $I_{SOURCE} = 10mA$	13.7	13.9		13.7	13.9		V
		Output Low, $I_{SINK} = 10mA$	-14.5	-14.7		-14.5	-14.7		V
I_S	Supply Current per Amplifier		0.7	2.2	3.0	0.7	2.2	3.0	mA

$V_S = \pm 15V$, $V_{CM} = 0V$, $V_{OUT} = 0V$, $-55^\circ C \leq T_A \leq 125^\circ C$, unless otherwise noted.

SYMBOL	PARAMETER	CONDITIONS	LT1211AM			LT1211M			UNITS
			MIN	TYP	MAX	MIN	TYP	MAX	
V_{OS}	Input Offset Voltage			200	500		300	800	μV
$\frac{\Delta V_{OS}}{\Delta T}$	Input Offset Voltage Drift (Note 3)			0.7	1.5		1	3	$\mu V/^\circ C$
I_{OS}	Input Offset Current			10	40		10	60	nA
I_B	Input Bias Current			55	110		60	140	nA
	Input Voltage Range		13.1	13.2		13.1	13.2		V
			-14.6	-14.8		-14.6	-14.8		V
CMRR	Common-Mode Rejection Ratio	$V_{CM} = -14.6V$ to $13.1V$	87	103		81	100		dB
PSRR	Power Supply Rejection Ratio	$V_S = \pm 2V$ to $\pm 15V$	87	111		84	107		dB
A_{VOL}	Large-Signal Voltage Gain	$V_O = 0V$ to $\pm 10V$, $R_L = 2k$	800	1500		800	1500		V/mV
	Maximum Output Voltage Swing	Output High, $I_{SOURCE} = 10mA$	13.6	13.8		13.6	13.8		V
		Output Low, $I_{SINK} = 10mA$	-14.3	-14.5		-14.3	-14.5		V
I_S	Supply Current per Amplifier		0.5	2.3	3.4	0.5	2.3	3.4	mA

3.3V ELECTRICAL CHARACTERISTICS

$V_S = 3.3V$, $V_{CM} = 0.5V$, $V_{OUT} = 0.5V$, $T_A = 25^\circ C$, unless otherwise noted. (Note 7)

SYMBOL	PARAMETER	CONDITIONS	LT1211AC LT1211AM			LT1211C/LT1211M LT1212C			UNITS
			MIN	TYP	MAX	MIN	TYP	MAX	
V_{OS}	Input Offset Voltage			75	150		100	275	μV
	Input Voltage Range (Note 8)		1.8 0	2.1 -0.3		1.8 0	2.1 -0.3		V V
	Maximum Output Voltage Swing	Output High, No Load	2.60	2.70		2.60	2.70		V
		Output High, $I_{SOURCE} = 1mA$	2.50	2.60		2.50	2.60		V
		Output High, $I_{SOURCE} = 15mA$	2.15	2.30		2.15	2.30		V
		Output Low, No Load		0.003	0.006		0.003	0.006	V
		Output Low, $I_{SINK} = 1mA$		0.047	0.065		0.047	0.065	V
		Output Low, $I_{SINK} = 15mA$		0.362	0.500		0.362	0.500	V
I_O	Maximum Output Current		± 20	± 50		± 20	± 50	mA	

$V_S = 3.3V$, $V_{CM} = 0.5V$, $V_{OUT} = 0.5V$, $0^\circ C \leq T_A \leq 70^\circ C$, unless otherwise noted. (Note 7)

SYMBOL	PARAMETER	CONDITIONS	LT1211AC			LT1211C/LT1212C			UNITS
			MIN	TYP	MAX	MIN	TYP	MAX	
V_{OS}	Input Offset Voltage			100	175		150	375	μV
	Input Voltage Range (Note 8)		1.7 0.1	1.4 -0.1		1.7 0.1	1.8 -0.1		V V
	Maximum Output Voltage Swing	Output High, No Load	2.50	2.63		2.50	2.63		V
		Output High, $I_{SOURCE} = 1mA$	2.40	2.53		2.40	2.53		V
		Output High, $I_{SOURCE} = 10mA$	2.20	2.33		2.20	2.33		V
		Output Low, No Load		0.004	0.007		0.004	0.007	V
		Output Low, $I_{SINK} = 1mA$		0.052	0.070		0.052	0.070	V
		Output Low, $I_{SINK} = 10mA$		0.290	0.400		0.290	0.400	V

$V_S = 3.3V$, $V_{CM} = 0.5V$, $V_{OUT} = 0.5V$, $-40^\circ C \leq T_A \leq 85^\circ C$, unless otherwise noted. (Note 5, 7)

SYMBOL	PARAMETER	CONDITIONS	LT1211AC			LT1211C/LT1212C			UNITS
			MIN	TYP	MAX	MIN	TYP	MAX	
V_{OS}	Input Offset Voltage			120	200		175	500	μV
	Input Voltage Range (Note 8)		1.4 0.2	1.5 0		1.4 0.2	1.5 0		V V
	Maximum Output Voltage Swing	Output High, No Load	2.45	2.55		2.45	2.55		V
		Output High, $I_{SOURCE} = 1mA$	2.30	2.46		2.30	2.46		V
		Output High, $I_{SOURCE} = 10mA$	2.10	2.26		2.10	2.26		V
		Output Low, No Load		0.005	0.008		0.005	0.008	V
		Output Low, $I_{SINK} = 1mA$		0.053	0.075		0.053	0.075	V
		Output Low, $I_{SINK} = 10mA$		0.300	0.420		0.300	0.420	V

$V_S = 3.3V$, $V_{CM} = 0.5V$, $V_{OUT} = 0.5V$, $-55^\circ C \leq T_A \leq 125^\circ C$, unless otherwise noted. (Note 7)

SYMBOL	PARAMETER	CONDITIONS	LT1211AM			LT1211M			UNITS
			MIN	TYP	MAX	MIN	TYP	MAX	
V_{OS}	Input Offset Voltage			130	250		200	500	μV
	Input Voltage Range (Note 8)		1.4 0.4	1.5 0.2		1.4 0.4	1.5 0.2		V V
	Maximum Output Voltage Swing	Output High, No Load	2.40	2.50		2.40	2.50		V
		Output High, $I_{SOURCE} = 1mA$	2.25	2.40		2.25	2.40		V
		Output High, $I_{SOURCE} = 10mA$	2.00	2.20		2.00	2.20		V
		Output Low, No Load		0.007	0.010		0.007	0.010	V
		Output Low, $I_{SINK} = 1mA$		0.060	0.085		0.060	0.085	V
		Output Low, $I_{SINK} = 10mA$		0.350	0.500		0.350	0.500	V

LT1211/LT1212

ELECTRICAL CHARACTERISTICS

Note 1: A heat sink may be required to keep the junction temperature below absolute maximum when the output is shorted indefinitely.

Note 2: T_J is calculated from the ambient temperature T_A and power dissipation P_D according to the following formulas:

LT1211MJ8, LT1211AMJ8:	$T_J = T_A + (P_D \times 100^\circ\text{C/W})$
LT1211CN8, LT1211ACN8:	$T_J = T_A + (P_D \times 100^\circ\text{C/W})$
LT1211CS8:	$T_J = T_A + (P_D \times 150^\circ\text{C/W})$
LT1212CN:	$T_J = T_A + (P_D \times 70^\circ\text{C/W})$
LT1212CS:	$T_J = T_A + (P_D \times 100^\circ\text{C/W})$

Note 3: This parameter is not 100% tested.

Note 4: Guaranteed by correlation to 3.3V and $\pm 15\text{V}$ tests.

Note 5: The LT1211/LT1212 are not tested and are not quality-assurance sampled at -40°C and at 85°C . These specifications are guaranteed by design, correlation and/or inference from -55°C , 0°C , 25°C , 70°C and/or 125°C tests.

Note 6: Slew rate is measured between $\pm 8.5\text{V}$ on an output swing of $\pm 10\text{V}$ on $\pm 15\text{V}$ supplies.

Note 7: Most LT1211/LT1212 electrical characteristics change very little with supply voltage. See the 5V tables for characteristics not listed in the 3.3V table.

Note 8: Guaranteed by correlation to 5V and $\pm 15\text{V}$ tests.

Note 9: Guaranteed by correlation to 3.3V tests.

TYPICAL PERFORMANCE CHARACTERISTICS

Distribution of Input Offset Voltage

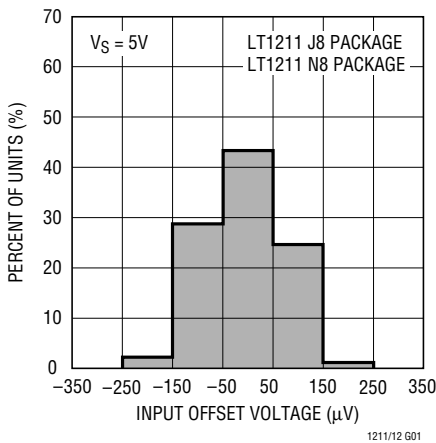

Distribution of Offset Voltage Drift with Temperature

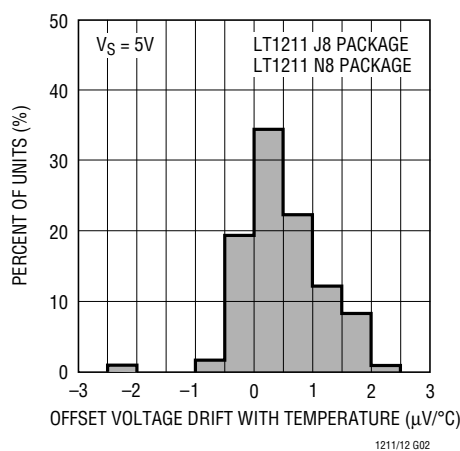

Distribution of Input Offset Voltage

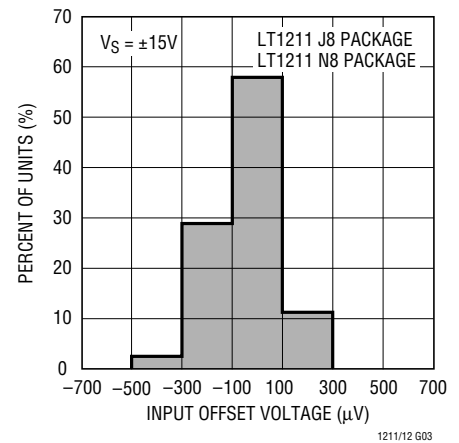

Distribution of Input Offset Voltage

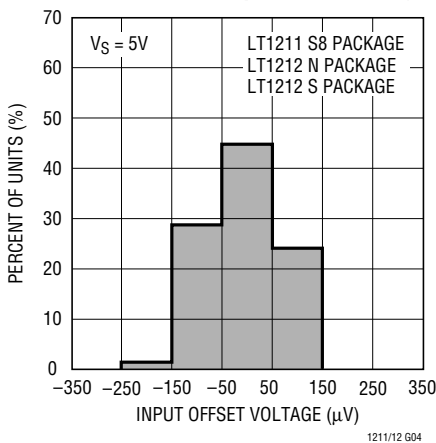

Distribution of Offset Voltage Drift with Temperature

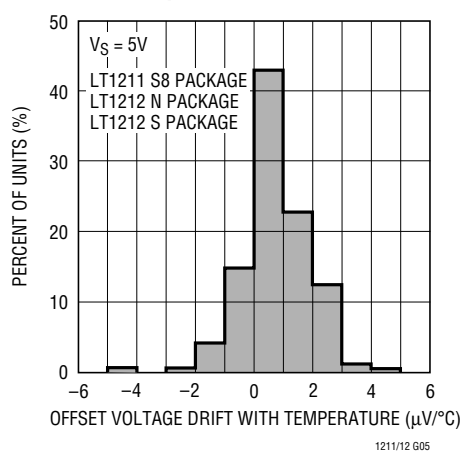

Distribution of Input Offset Voltage

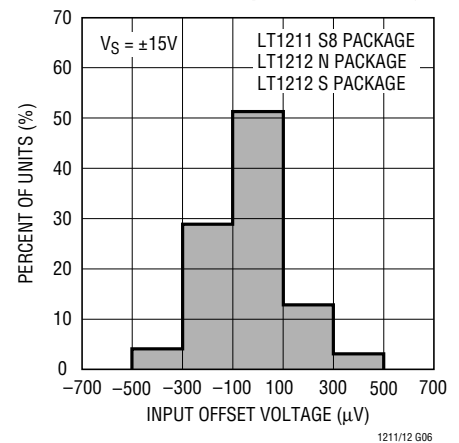

TYPICAL PERFORMANCE CHARACTERISTICS

Voltage Gain vs Frequency

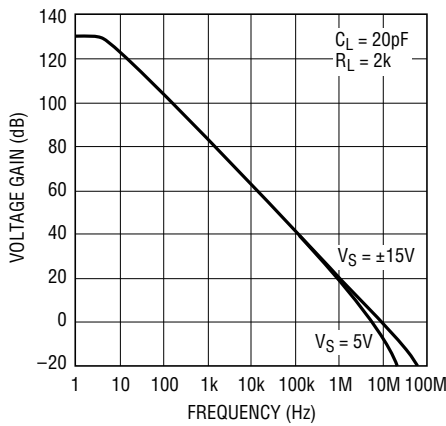

1211/12 G07

Voltage Gain, Phase vs Frequency

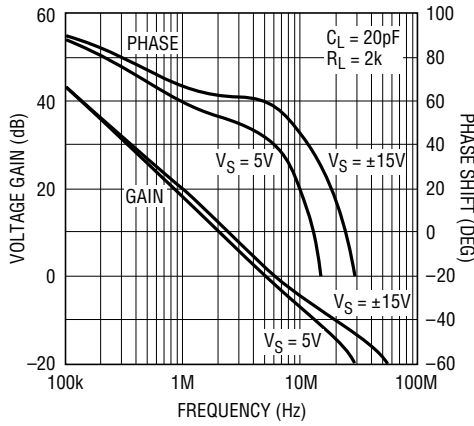

1211/12 G08

Gain-Bandwidth Product, Phase Margin vs Supply Voltage

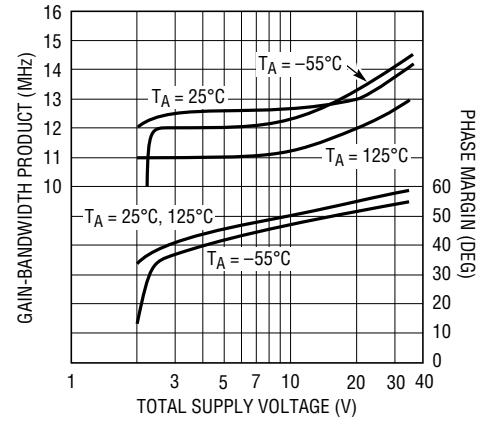

1211/12 G09

Slew Rate vs Temperature

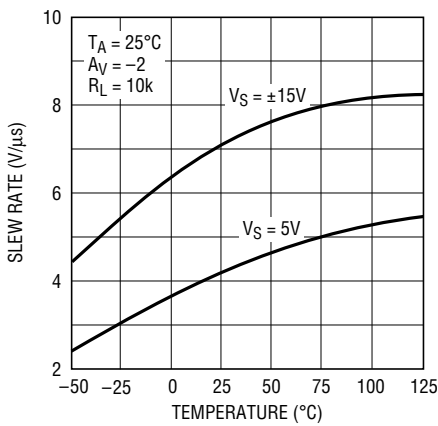

1211/12 G10

Slew Rate vs Supply Voltage

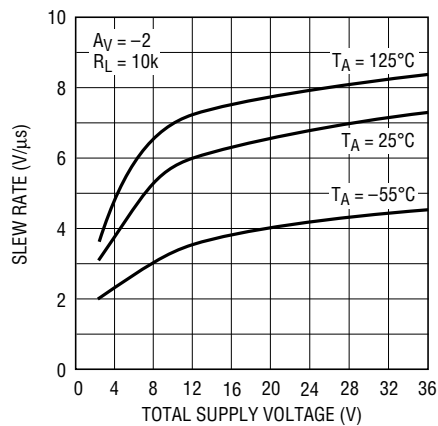

1211/12 G11

Capacitive Load Handling

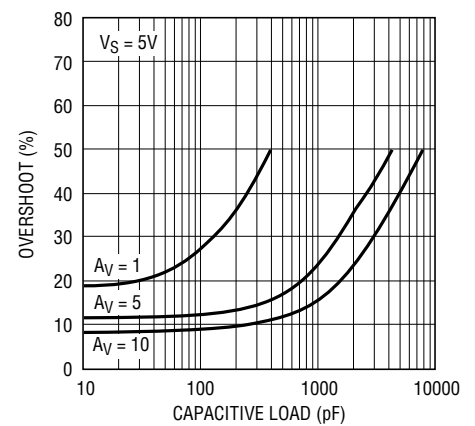

1211/12 G12

Undistorted Output Swing vs Frequency, VS = 5V

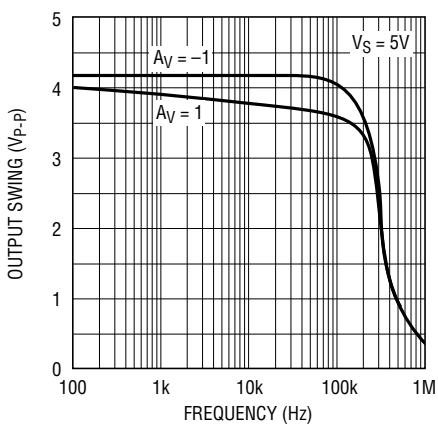

1211/12 G13

Undistorted Output Swing vs Frequency, VS = ±15V

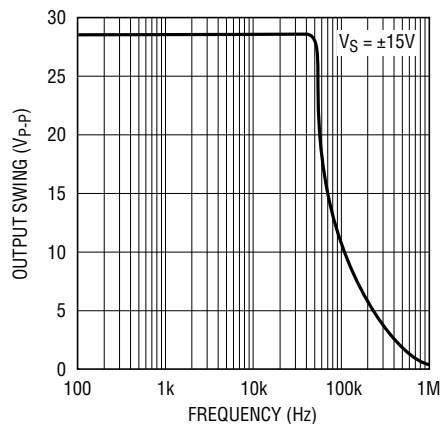

1211/12 G14

Total Harmonic Distortion and Noise vs Frequency

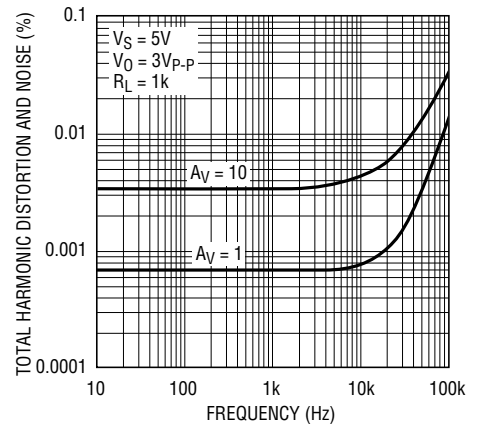

1211/12 G15

TYPICAL PERFORMANCE CHARACTERISTICS

Open-Loop Voltage Gain vs Supply Voltage

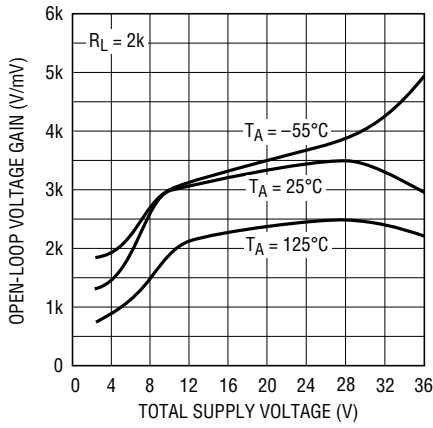

Open-Loop Gain, $V_S = 5V$

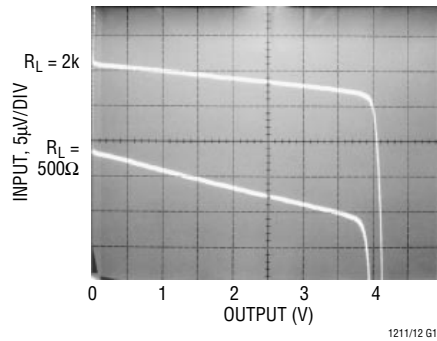

Positive Output Saturation Voltage vs Temperature

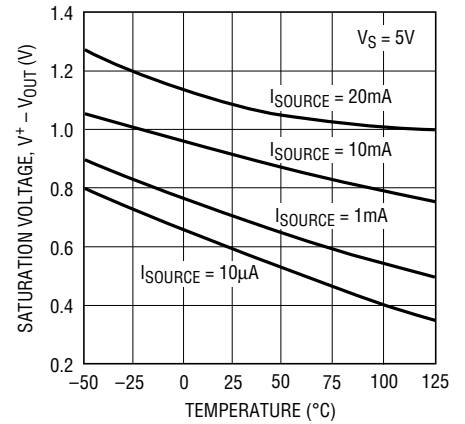

Voltage Gain vs Load Resistance

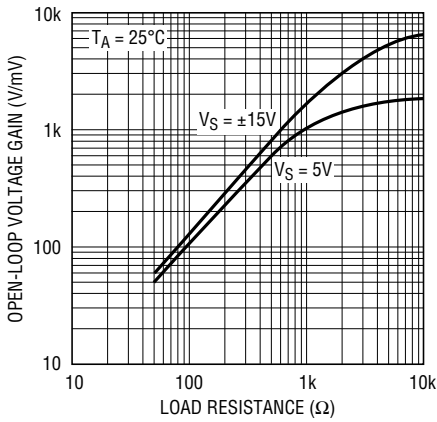

Open-Loop Gain, $V_S = \pm 15V$

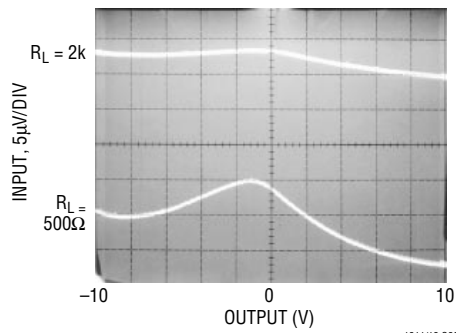

Negative Output Saturation Voltage vs Temperature

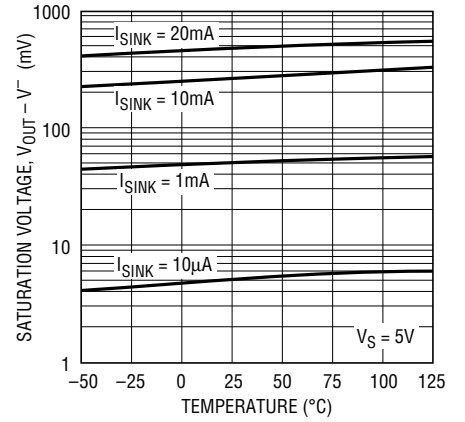

Channel Separation vs Frequency

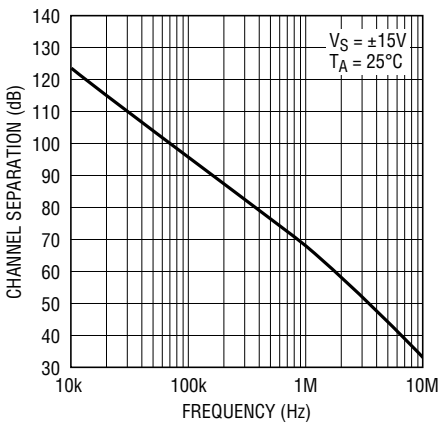

Output Short-Circuit Current vs Temperature

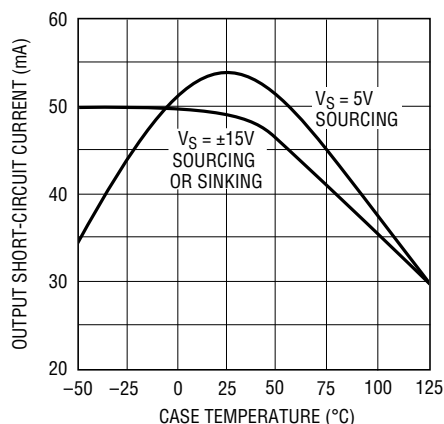

Output Impedance vs Frequency

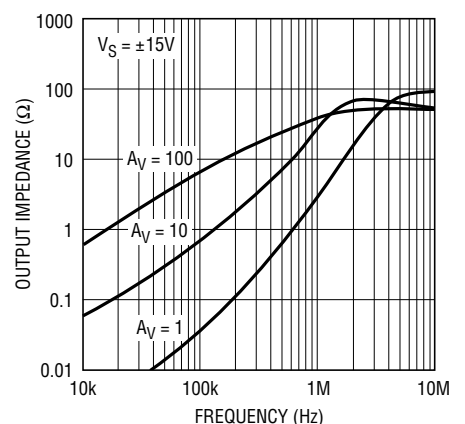

TYPICAL PERFORMANCE CHARACTERISTICS

5V Small-Signal Response

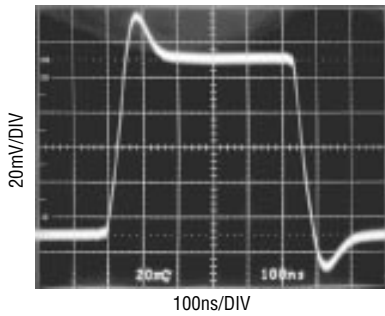

$V_S = 5V$
 $A_V = 1$

1211/12 G25

5V Large-Signal Response

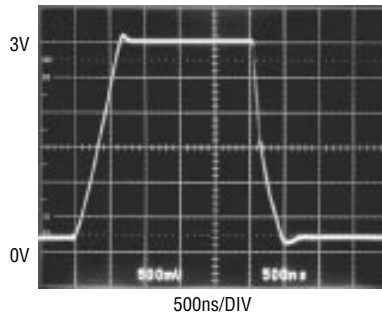

$V_S = 5V$
 $A_V = 1$

1211/12 G26

5V Large-Signal Response

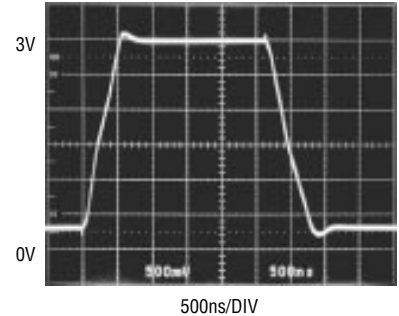

$V_S = 5V$
 $A_V = -1$
 $R_F = R_G = 1k$
 $C_F = 20pF$

1211/12 G27

±15V Small-Signal Response

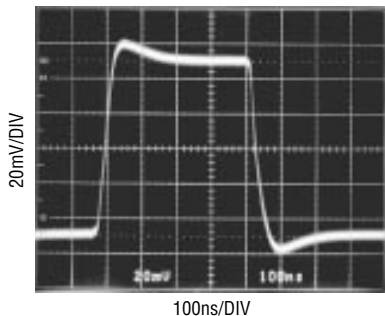

$V_S = \pm 15V$
 $A_V = 1$

1211/12 G28

±15V Large-Signal Response

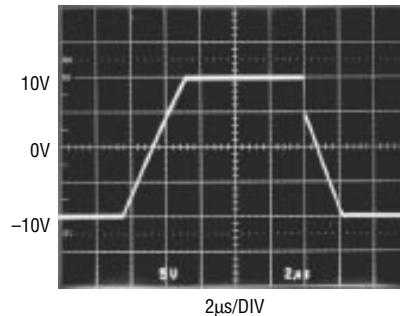

$V_S = \pm 15V$
 $A_V = 1$

1211/12 G29

±15V Large-Signal Response

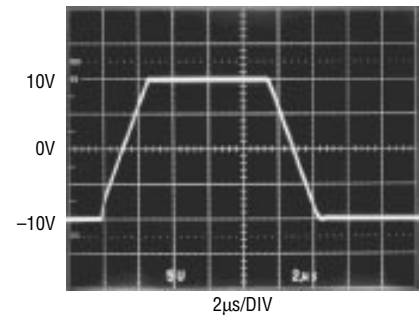

$V_S = \pm 15V$
 $A_V = -1$
 $R_F = R_G = 1k$

1211/12 G30

5V Settling

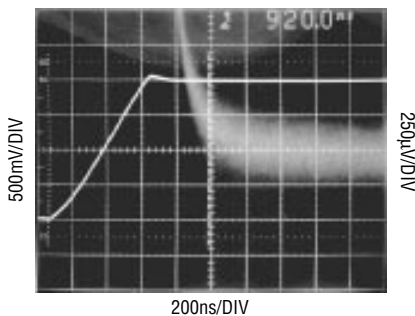

$V_S = 5V$
 $A_V = 1$

1211/12 G31

±15V Settling

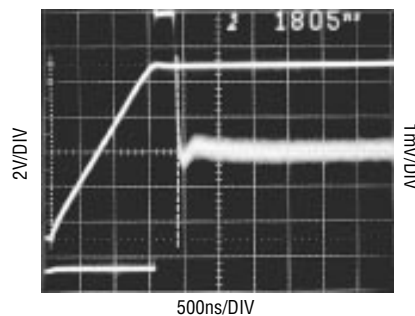

$V_S = \pm 15V$
 $A_V = -1$

1211/12 G32

Settling Time to 0.01% vs Output Step

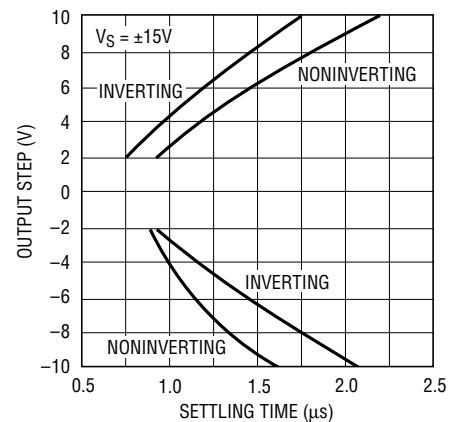

1211/12 G33

TYPICAL PERFORMANCE CHARACTERISTICS

Supply Current vs Supply Voltage

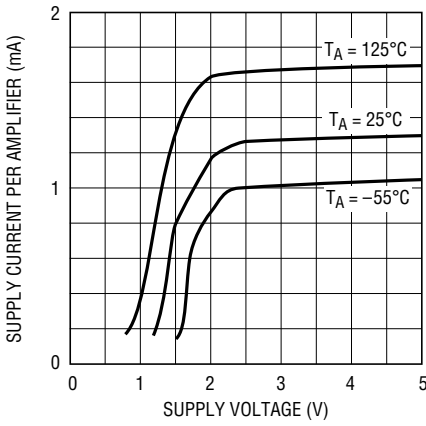

Supply Current vs Temperature

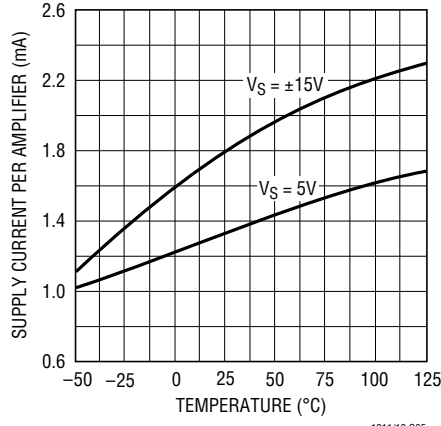

Warm-Up Drift vs Time

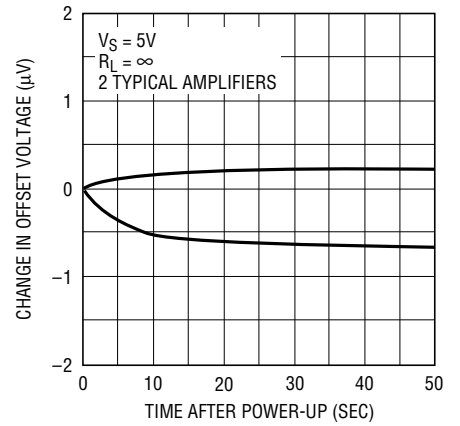

Input Bias Current vs Temperature

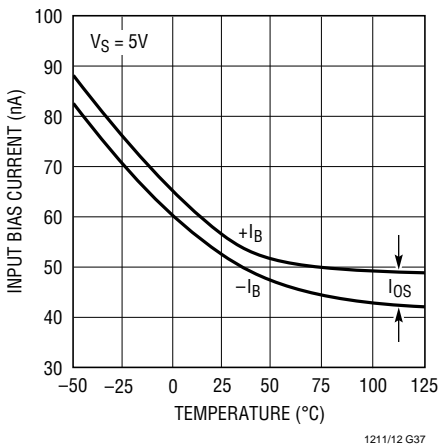

Input Bias Current vs Common-Mode Voltage

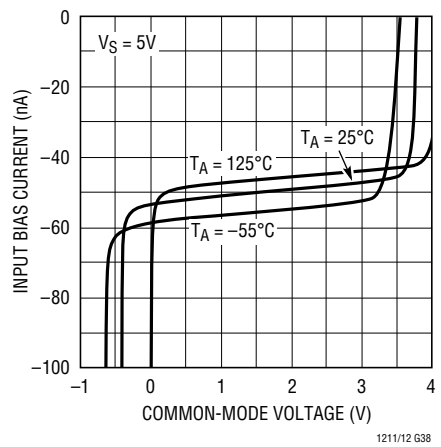

Common-Mode Range vs Temperature

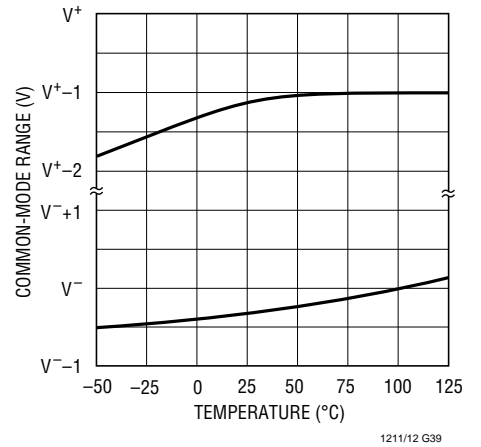

Input Noise Current, Noise Voltage Density vs Frequency

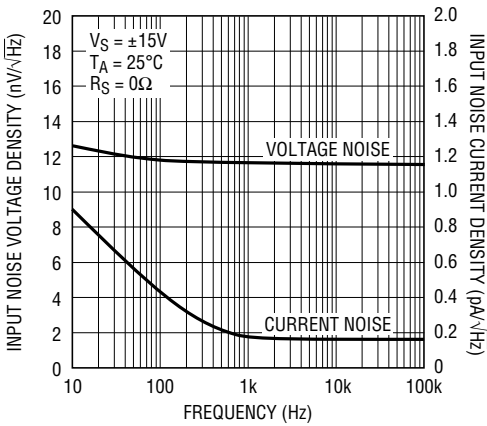

Common-Mode Rejection Ratio vs Frequency

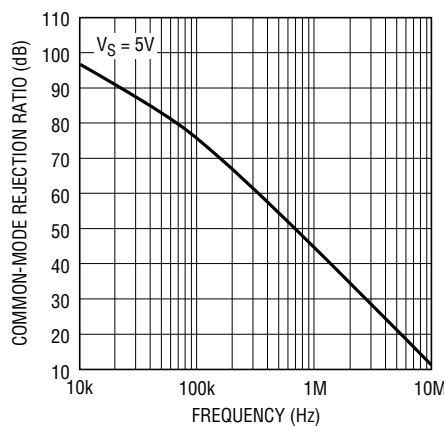

Input Referred Power Supply Rejection Ratio vs Frequency

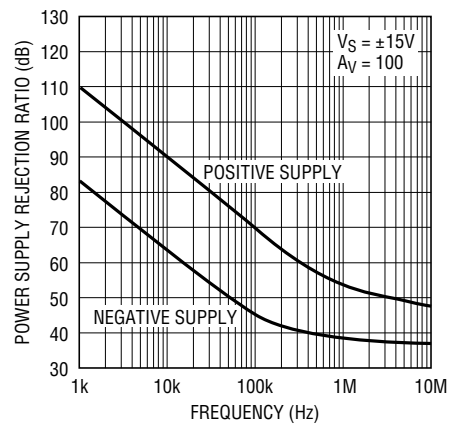

APPLICATIONS INFORMATION

Supply Voltage

The LT1211/LT1212 op amps are fully functional and all internal bias circuits are in regulation with 2.2V of supply. The amplifiers will continue to function with as little as 1.5V, although the input common-mode range and the phase margin are about gone. The minimum operating supply voltage is guaranteed by the PSRR tests which are done with the input common mode equal to 500mV and a minimum supply voltage of 2.5V. The LT1211/LT1212 are guaranteed over the full -55°C to 125°C range with a minimum supply voltage of 2.5V.

The positive supply pin of the LT1211/LT1212 should be bypassed with a small capacitor (about $0.01\mu\text{F}$) within an inch of the pin. When driving heavy loads and for good settling time, an additional $4.7\mu\text{F}$ capacitor should be used. When using split supplies, the same is true for the negative supply pin.

Power Dissipation

The LT1211/LT1212 amplifiers combine high speed and large output current drive into very small packages. Because these amplifiers work over a very wide supply range, it is possible to exceed the maximum junction temperature under certain conditions. To insure that the LT1211/LT1212 are used properly, calculate the worst case power dissipation, define the maximum ambient temperature, select the appropriate package and then calculate the maximum junction temperature.

The worst case amplifier power dissipation is the total of the quiescent current times the total power supply voltage plus the power in the IC due to the load. The quiescent supply current of the LT1211/LT1212 has a positive temperature coefficient. The maximum supply current of each amplifier at 125°C is given by the following formula:

$$I_{\text{SMAX}} = 2.5 + 0.036 \times (V_S - 5) \text{ in mA}$$

V_S is the total supply voltage.

The power in the IC due to the load is a function of the output voltage, the supply voltage and load resistance. The worst case occurs when the output voltage is at half supply, if it can go that far, or its maximum value if it cannot reach half supply.

For example, calculate the worst case power dissipation while operating on $\pm 15\text{V}$ supplies and driving a 500Ω load.

$$I_{\text{SMAX}} = 2.5 + 0.036 \times (30 - 5) = 3.4\text{mA}$$

$$P_{\text{DMAX}} = 2 \times V_S \times I_{\text{SMAX}} + (V_S - V_{\text{OMAX}}) \times V_{\text{OMAX}}/R_L$$

$$P_{\text{DMAX}} = 2 \times 15\text{V} \times 3.4\text{mA} + (15\text{V} - 7.5\text{V}) \times 7.5\text{V}/500 \\ = 0.102 + 0.113 = 0.215\text{W per Amp}$$

If this is the quad LT1212, the total power in the package is four times that, or 0.860W . Now calculate how much the die temperature will rise above the ambient. The total power dissipation times the thermal resistance of the package gives the amount of temperature rise. For this example, in the SO surface mount package, the thermal resistance is $100^{\circ}\text{C}/\text{W}$ junction-to-ambient in still air.

$$\text{Temperature Rise} = P_{\text{DMAX}} \times \theta_{\text{JA}} = 0.860\text{W} \times 100^{\circ}\text{C}/\text{W} \\ = 86^{\circ}\text{C}$$

The maximum junction temperature allowed in the plastic package is 150°C . Therefore the maximum ambient allowed is the maximum junction temperature less the temperature rise.

$$\text{Maximum Ambient} = 150^{\circ}\text{C} - 86^{\circ}\text{C} = 64^{\circ}\text{C}$$

That means the SO quad can only be operated at or below 64°C on $\pm 15\text{V}$ supplies with a 500Ω load.

As a guideline to help in the selection of the LT1211/LT1212, the following table describes the maximum supply voltage that can be used with each part based on the following assumptions:

1. The maximum ambient is 70°C or 125°C depending on the part rating.
2. The load is 500Ω , includes the feedback resistors.
3. The output can be anywhere between the supplies.

PART	MAX SUPPLIES	MAX POWER AT MAX T_A
LT1211MJ8	19.5V or $\pm 16.4\text{V}$	500mW
LT1211CN8	25.2V or $\pm 18.0\text{V}$	800mW
LT1211CS8	20.3V or $\pm 17.1\text{V}$	533mW
LT1212CN	21.0V or $\pm 17.8\text{V}$	1143mW
LT1212CS	17.3V or $\pm 14.4\text{V}$	800mW

APPLICATIONS INFORMATION

Inputs

Typically, at room temperature, the inputs of the LT1211/LT1212 can common mode 400mV below ground (V^-) and to within 1.2V of the positive supply with the amplifier still functional. However the input bias current and offset voltage will shift as shown in the characteristic curves. For full precision performance, the common-mode range should be limited between ground (V^-) and 1.5V below the positive supply.

When either of the inputs is taken below ground (V^-) by more than about 700mV, that input bias current will increase dramatically. The current is limited by internal 100 Ω resistors between the input pins and diodes to each supply. The output will remain low (no phase reversal) for inputs 1.3V below ground (V^-). If the output does not have to sink current, such as in a single supply system with a 1k load to ground, there is no phase reversal for inputs up to 8V below ground.

There are no clamps across the inputs of the LT1211/LT1212 and therefore each input can be forced to any voltage between the supplies. The input current will remain constant at about 60nA over most of this range. When an input gets closer than 1.5V to the positive supply, that input current will gradually decrease to zero until the input goes above the supply, then it will increase due to the previously mentioned diodes. If the inverting input is held more positive than the noninverting input by 200mV or more, while at the same time the noninverting input is within 300mV of ground (V^-), then the supply current will increase by 1mA and the noninverting input current will increase to about 10 μ A. This should be kept in mind in comparator applications where the inverting input stays above ground (V^-) and the noninverting input is at or near ground (V^-).

Output

The output of the LT1211/LT1212 will swing to within 0.60V of the positive supply with no load. The open-loop output resistance, when the output is driven hard into the

positive rail, is about 100 Ω as the output starts to source current; this resistance drops to about 25 Ω as the current increases. Therefore when the output sources 1mA, the output will swing to within 0.7V of the positive supply. While sourcing 20mA, it is within 1.1V of the positive supply.

The output of the LT1211/LT1212 will swing to within 3mV of the negative supply while sinking zero current. Thus, in a typical single supply application with the load going to ground, the output will go to within 3mV of ground. The open-loop output resistance when the output is driven hard into the negative rail is about 44 Ω at low currents and reduces to about 24 Ω at high currents. Therefore, when the output sinks 1mA, the output is about 42mV above the negative supply and while sinking 20mA, it is about 480mV above it.

The output of the LT1211/LT1212 has reverse-biased diodes to each supply. If the output is forced beyond either supply, unlimited currents will flow. If the current is transient and limited to several hundred mA, no damage will occur.

Feedback Components

Because the input currents of the LT1211/LT1212 are less than 125nA, it is possible to use high value feedback resistors to set the gain. However, care must be taken to insure that the pole that is formed by the feedback resistors and the input capacitance does not degrade the stability of the amplifier. For example, if a single supply, noninverting gain of two is set with two 20k resistors, the LT1211/LT1212 will probably oscillate. This is because the amplifier goes open-loop at 3MHz (6dB of gain) and has 50° of phase margin. The feedback resistors and the 10pF input capacitance generate a pole at 1.6MHz that introduces 63° of phase shift at 3MHz! The solution is simple; use lower value resistors or add a feedback capacitor of 10pF or more.

APPLICATIONS INFORMATION

Comparator Applications

Sometimes it is desirable to use an op amp as a comparator. When operating the LT1211/LT1212 on a single 3.3V or 5V supply, the output interfaces directly with most TTL and CMOS logic.

The response time of the LT1211/LT1212 is a strong function of the amount of input overdrive as shown in the

following photos. These amplifiers are unity-gain stable op amps and not fast comparators, therefore, the logic being driven may oscillate due to the long transition time. The output can be speeded up by adding 20mV or more of hysteresis (positive feedback), but the offset is then a function of the input direction.

LT1211 Comparator Response (+)
20mV, 10mV, 5mV, 2mV Overdrives

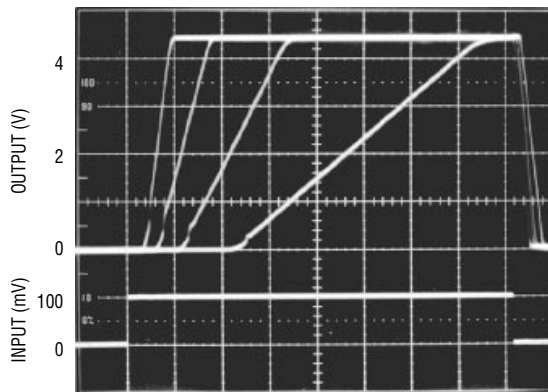

$V_S = 5V$
 $R_L = \infty$

5µs/DIV

1211/12 AI01

LT1211 Comparator Response (-)
20mV, 10mV, 5mV, 2mV Overdrives

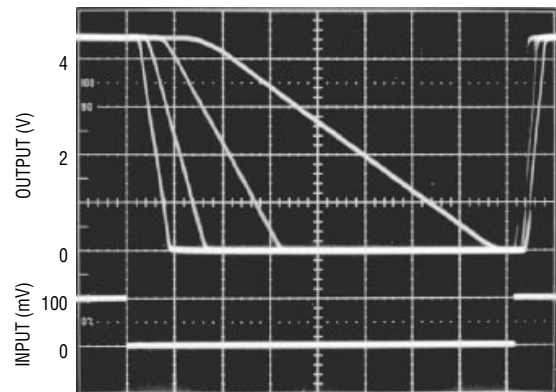

$V_S = 5V$
 $R_L = \infty$

5µs/DIV

1211/12 AI02

SIMPLIFIED SCHEMATIC

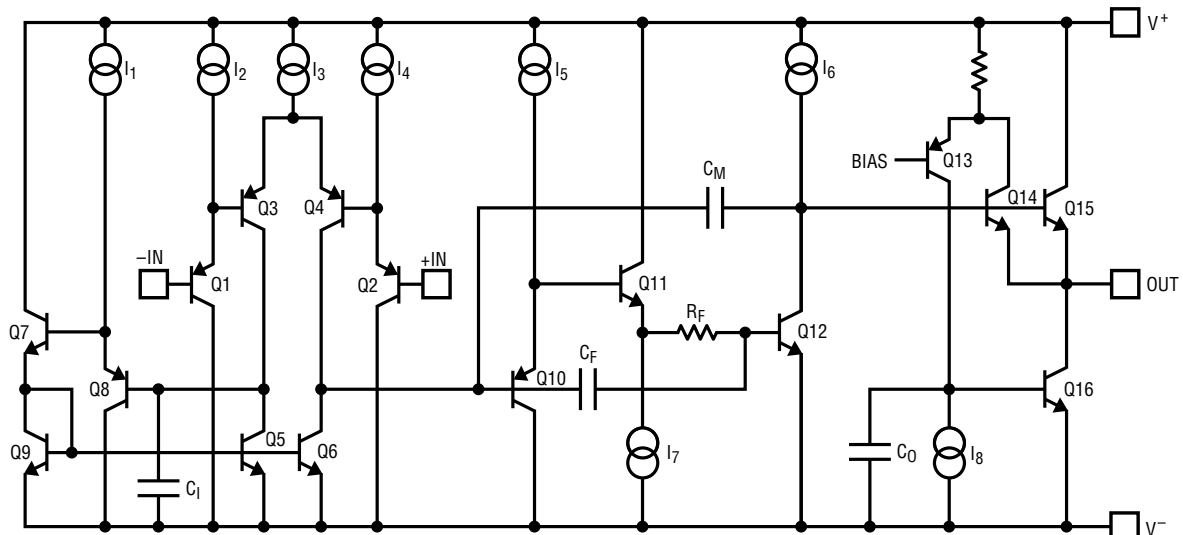

1211/12 SS

LT1211/LT1212

TYPICAL APPLICATIONS

Single Supply, 100kHz, 4th Order Butterworth Lowpass Filter

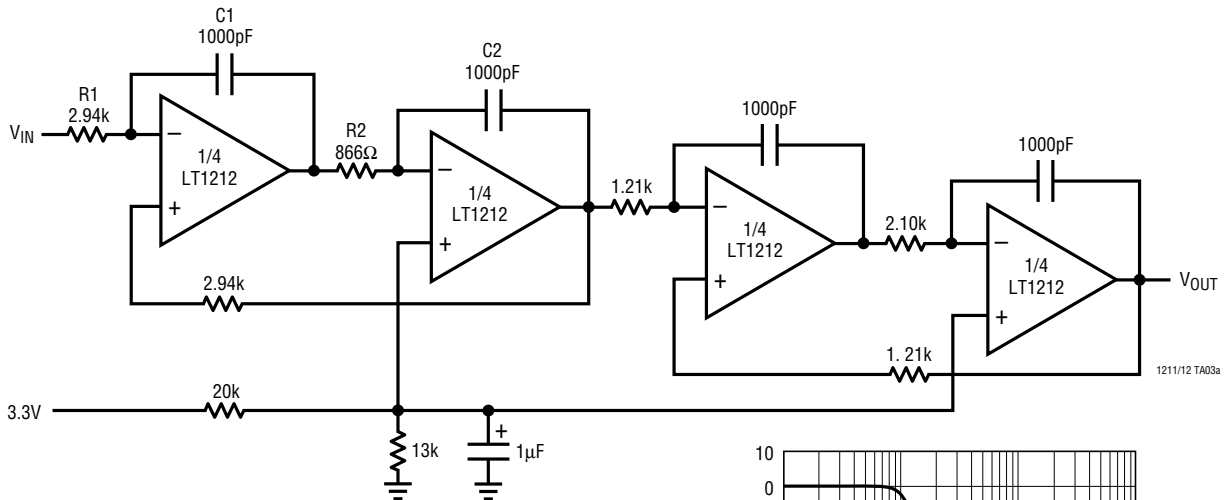

12-BIT ACCURATE SIGNAL RANGE FROM 6mV TO 1.8V ON 3.3V SINGLE SUPPLY. MAXIMUM OUTPUT OFFSET ERROR IS 676μV.

FOR EACH 2ND ORDER SECTION:

$$W_0^2 = \frac{1}{C1C2R1R2}$$

$$R1 = \frac{1}{W_0QC1}$$

$$R2 = \frac{Q}{W_0C2}$$

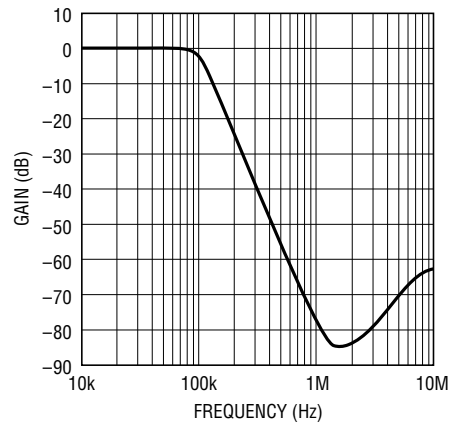

1A Voltage-Controlled Current Source

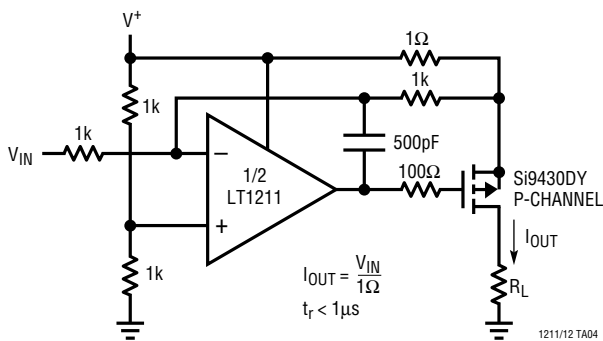

1A Voltage-Controlled Current Sink

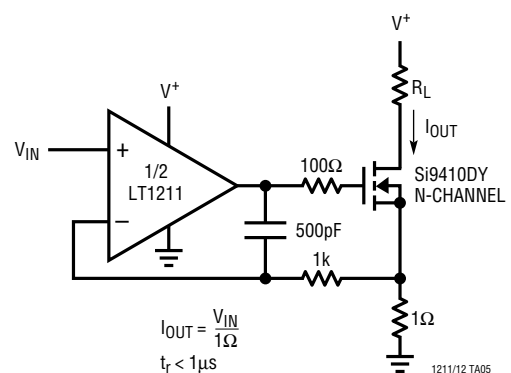

PACKAGE DESCRIPTION

For package description please see other Linear Technology data sheets or databooks.