



## INFRARED REMOTE CONTROL RECEIVER

### ■ GENERAL DESCRIPTION

NJL60H/V000A series are small and high performance receiving devices for infrared remote control system. Regarding the transmission distance, NJL60H/V000A is longer than NJL60H/V000. The pulse width of NJL60H/V000A series are stable relating to commander's power or distance between transmitter and receiver. NJL60H/V000A series have five kinds of package including three types of metal case to meet the various applications.

### ■ FEATURES

1. Mold type and metal case type to meet the design of front panel.
2. Elliptic lens to improve the characteristic against light noise from the upper and lower side.
3. Line-up for various center carrier frequencies.

### ■ APPLICATIONS

1. AV instruments such as Audio, TV, VCR, CD, MD, etc.
2. Home appliances such as Air-conditioner, Fan, etc.
3. The other equipments with wireless remote control.

### ■ LINE-UP

Mold/ Metal Case	Mold Type		Metal Case Type		
	Top	Side	Top		
View					
Height					
Carrier Frequency	5.4 mm	6.3 mm	8 mm	11 mm	15 mm
fo=30 KHz	NJL61H300A	NJL61V300A	NJL62H300A	NJL63H300A	NJL64H300A
32.75KHz	NJL61H328A	NJL61V328A	NJL62H328A	NJL63H328A	NJL64H328A
36 KHz	NJL61H360A	NJL61V360A	NJL62H360A	NJL63H360A	NJL64H360A
36.7 KHz	NJL61H367A	NJL61V367A	NJL62H367A	NJL63H367A	NJL64H367A
38 KHz	NJL61H380A	NJL61V380A	NJL62H380A	NJL63H380A	NJL64H380A
40 KHz	NJL61H400A	NJL61V400A	NJL62H400A	NJL63H400A	NJL64H400A
56.8 KHz	NJL61H568A	NJL61V568A	NJL62H568A	NJL63H568A	NJL64H568A

※ Regarding the other frequencies or packages, please contact to NJRC individually.

### ■ BLOCK DIAGRAM

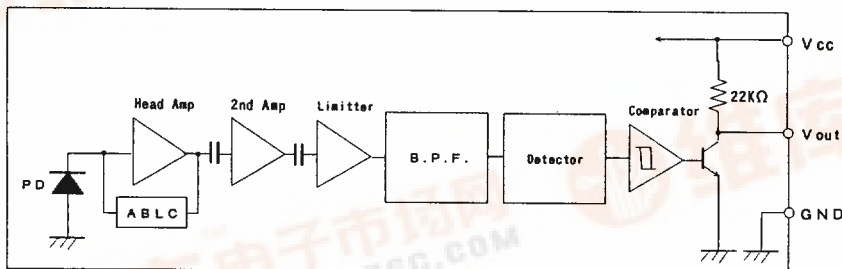

### ■ ABSOLUTE MAXIMUM RATINGS (Ta= 25 °C)

Supply Voltage	V <sub>cc</sub>	6.3V
Operating Temperature Range	T <sub>opr</sub>	-30 °C — +85 °C
Storage Temperature Range	T <sub>stg</sub>	-40 °C — +85 °C
Soldering Temperature	T <sub>sol</sub>	260 °C 5sec 4.0mm from mold body



## RECOMMENDED OPERATING CONDITION

Supply Voltage Range  $V_{CC}$  4.5V – 5.5V

## ELECTRO-OPTICAL CHARACTERISTICS ( $V_{CC} = 5.0V$ , $T_a = 25^\circ C$ )

PARAMETER	SYMBOL	TEST CONDITION	MIN	TYP	MAX	UNIT
Supply Current	$I_{CC}$	No Signal Input	—	—	3	mA
Transmission Distance	$L_c$	Direction of Ray Axis *1	13	18	—	m
Directivity	$\theta_L$	Angle of half $L_c$ , Horizontal *2	—	50	—	deg
	$\theta_V$	Angle of half $L_c$ , Vertical *2	—	35	—	deg
Output Voltage Low	$V_L$	No Load	—	0.2	0.5	V
Output Voltage High	$V_H$	No Load	4.5	—	—	V
Low Level Pulse Width	$T_{WL}$	See Test Circuit	400	—	800	$\mu s$
High Level Pulse Width	$T_{WH}$	See Test Circuit	400	—	800	$\mu s$
Center Frequency	$f_o$	See Line-up	30.0	—	56.8	KHz

Note \*1: Test with each center carrier frequency under the test condition shown below.

\*2: Place major axis of elliptic lens in horizontal direction and minor in vertical.

## TEST METHOD

Test condition is as follows:

### (1) Standard Transmitter:

Transmitting waveform is shown in Fig.1. Transmitting power should be adjusted so that output voltage  $V_{out}$  will be 400 mVp-p.

Regarding IR LED used for transmitter,  
 $\lambda_p = 940nm$ ,  $\Delta\lambda = 50nm$ .

Regarding photo diode, Sensitivity  
 $S = 26nA/Lx$ , in case light source  
 temperature  $2856^\circ K$ ,  $E_e = 100Lx$ ,  $V_R = 5V$

### (2) Test system: Shown in Fig.3.

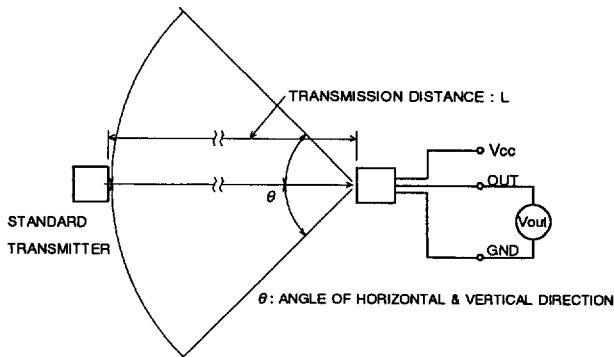

Fig. 3 TEST SYSTEM

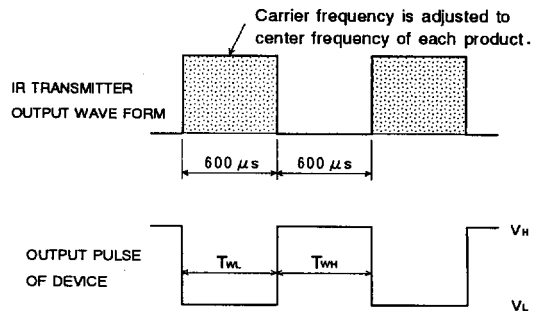

Fig. 1 TRANSMITTER WAVE FORM

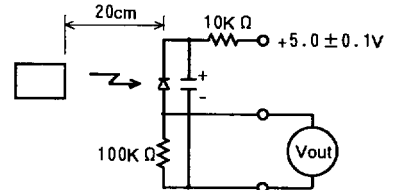
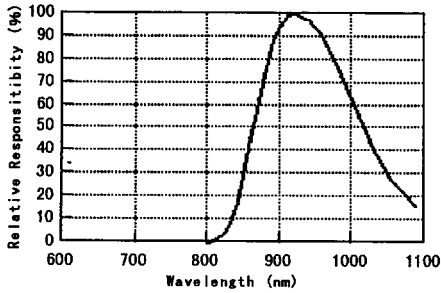

Fig. 2 STD. TRANSMITTER TEST CIRCUIT



## TYPICAL CHARACTERISTICS

Spectral Response  
( $T_a=25^\circ\text{C}$ )



Directivity  
( $T_a=25^\circ\text{C}$ )

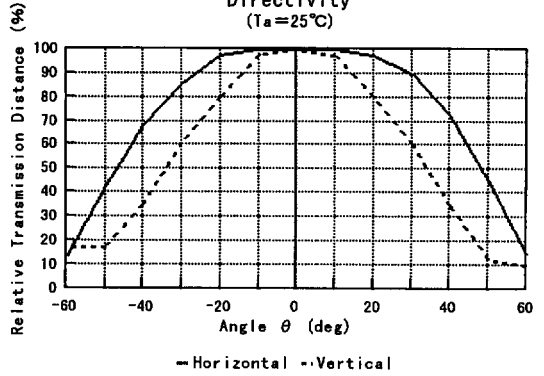

Output Pulse Width vs. Distance  
(Input Pulse Width=600  $\mu\text{s}$ ,  $V_{cc}=5.0\text{V}$ ,  $T_a=25^\circ\text{C}$ )

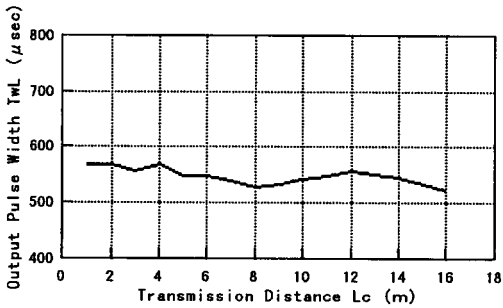

Transmission Distance vs. Supply Voltage  
( $T_a=25^\circ\text{C}$ )

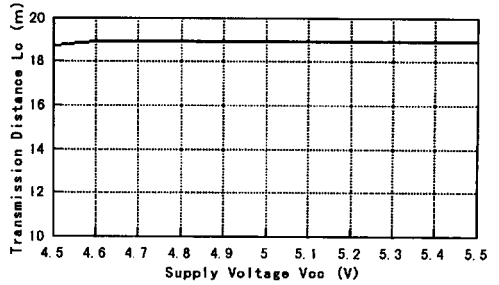

Transmission Distance vs. Carrier Frequency  
( $V_{cc}=5.0\text{V}$ ,  $T_a=25^\circ\text{C}$ )

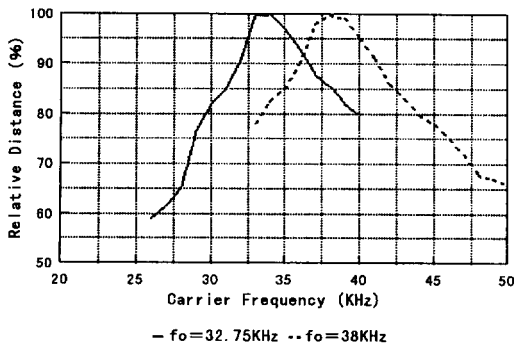

Transmission Distance vs. Temperature  
( $V_{cc}=5.0\text{V}$ )

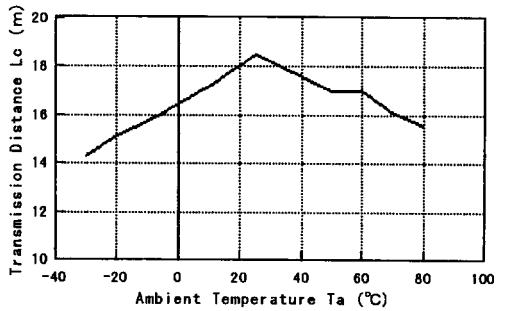



## RECOMMENDED APPLICATION CIRCUIT

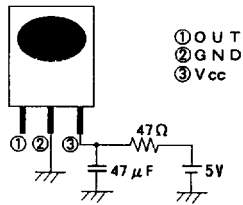

RC Filter should be connected closely between Vcc pin and GND pin.

## OUTLINE

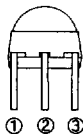
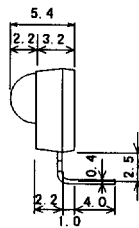
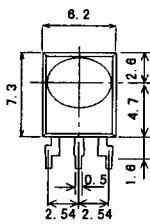

① OUT  
② GND  
③ Vcc

NJL61H000A  
UNIT : mm

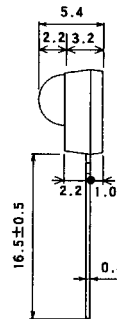
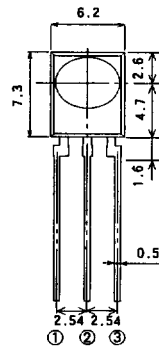

① OUT  
② GND  
③ Vcc

NJL61V000A  
UNIT : mm

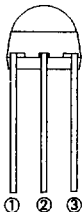
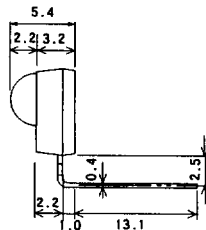
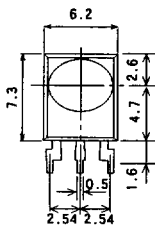

① OUT  
② GND  
③ Vcc

NJL61H000AF3  
UNIT : mm



# NJL61H/61V/62H/63H/64H000A

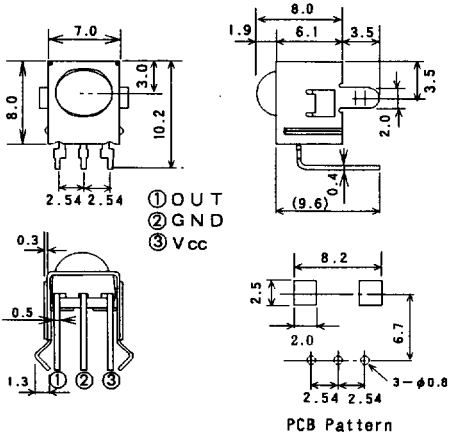

NJL62H000A  
UNIT : mm

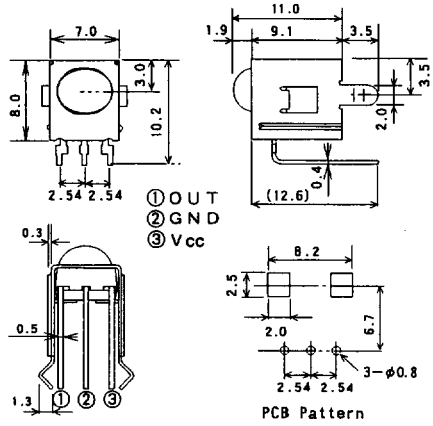

NJL63H000A  
UNIT : mm

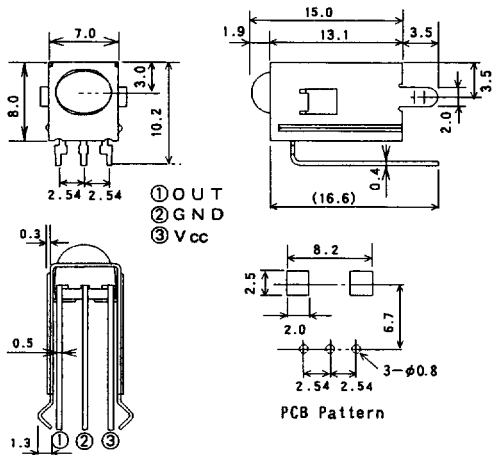

NJL64H000A  
UNIT : mm

1. Tolerance is  $\pm 0.3\text{mm}$  unless otherwise noted.
2. Ground metal case on PCB. Metal case is not connected to GND pin inside.