



655 MHz Low Jitter Clock Generator

AD9540

FEATURES

- Excellent intrinsic jitter performance
- 25 Mb/s write-speed serial I/O control
- 200 MHz phase frequency detector inputs
- 655 MHz programmable input dividers for the phase frequency detector ($\div M, \div N$) {M, N = 1..16} (bypassable)
- Programmable RF divider ($\div R$) {R = 1, 2, 4, 8} (bypassable)
- 8 programmable internal clock rates
- Programmable edge delay with 93 fs resolution
- 1.8 V supply for device operation
- 3.3 V supply for I/O, CML driver, and charge pump output
- Software controlled power-down
- 48-lead LFCSP package
- Programmable charge pump current (up to 4 mA)
- Multichip synchronization
- Dual-mode PLL lock detect
- 655 MHz CML-mode PECL-compliant driver

APPLICATIONS

- Clocking high performance data converters
- Base station clocking applications
- Network (SONET/SDH) clocking
- Gigabit Ethernet (GbE) clocking
- Instrumentation clocking circuits

FUNCTIONAL BLOCK DIAGRAM

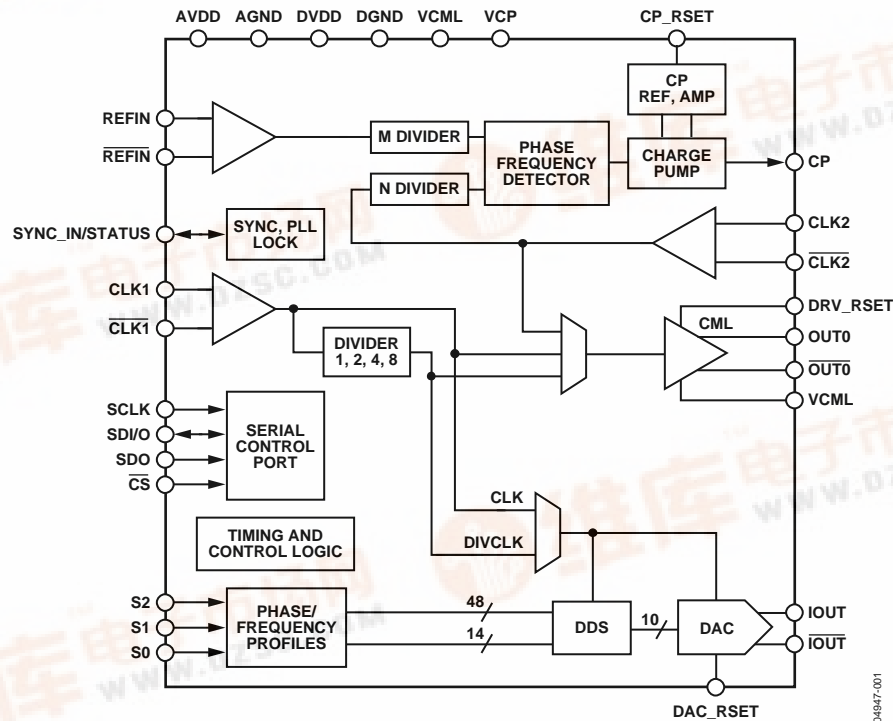

Figure 1.



TABLE OF CONTENTS

Product Overview.....	3	DDS and DAC	20
Specifications.....	4	Modes of Operation	21
Loop Measurement Conditions.....	9	Selectable Clock Frequencies and Selectable Edge Delay	21
Absolute Maximum Ratings.....	10	Synchronization Modes for Multiple Devices.....	21
ESD Caution.....	10	Serial Port Operation	22
Pin Configuration and Function Descriptions.....	11	Instruction Byte	23
Typical Performance Characteristics	13	Serial Interface Port Pin Description.....	23
Typical Application Circuits.....	18	MSB/LSB Transfers	23
Application Circuit Descriptions	18	Register Map and Description	24
General Description	19	Control Function Register Descriptions	27
PLL Circuitry	19	Outline Dimensions	32
CML Driver	19	Ordering Guide	32

REVISION HISTORY

7/04—Revision 0: Initial Version

PRODUCT OVERVIEW

The AD9540 is Analog Devices' first dedicated clocking product specifically designed to support the extremely stringent clocking requirements of the highest performance data converters.

The device features high performance PLL circuitry, including a flexible 200 MHz phase frequency detector and a digitally controlled charge pump current. The device also provides a low jitter, 655 MHz CML-mode, PECL-compliant output driver with programmable slew rates. External VCO rates up to 2.7 GHz are supported. Extremely fine tuning resolution (steps less than 2.33 μ Hz) is another feature supported by this device. Information is loaded into the AD9540 via a serial I/O port that has a device write-speed of 25 Mb/s. The AD9540 frequency divider block can also be programmed to support a spread spectrum mode of operation.

The AD9540 is specified to operate over the extended automotive range of -40°C to $+85^{\circ}\text{C}$.

AD9540

SPECIFICATIONS

AVDD = DVDD = 1.8 V ± 5%; DVDD_I/O = CP_VDD = 3.3 V ± 5% (@ T_A = 25°C), DAC_R_{SET} = 3.92 kΩ, CP_R_{SET} = 3.09 kΩ, DRV_R_{SET} = 4.02 kΩ, unless otherwise noted.

Table 1.

Parameter	Min	Typ	Max	Unit	Test Conditions/Comments
TOTAL SYSTEM JITTER AND PHASE NOISE FOR 105 MHz ADC CLOCK GENERATION CIRCUIT					
Converter Limiting Jitter ¹		720		f _s rms	
Resultant SNR		59.07		dB	
Phase Noise of Fundamental					
@ 10 Hz Offset		80		dBc/Hz	
@ 100 Hz Offset		92		dBc/Hz	
@ 1 kHz Offset		101		dBc/Hz	
@ 10 kHz Offset		110		dBc/Hz	
@ 100 kHz Offset		147		dBc/Hz	
≥1 MHz Offset		153		dBc/Hz	
TOTAL SYSTEM PHASE NOISE FOR 210 MHz ADC CLOCK GENERATION CIRCUIT					
Phase Noise of Fundamental					
@ 10 Hz Offset		79.2		dBc/Hz	
@ 100 Hz Offset		86		dBc/Hz	
@ 1 kHz Offset		95		dBc/Hz	
@ 10 kHz Offset		105		dBc/Hz	
@ 100 kHz Offset		144		dBc/Hz	
@ 1 MHz Offset		151		dBc/Hz	
TOTAL SYSTEM TIME JITTER FOR CLOCKS					
155.52 MHz Clock		581		f _s rms	12 kHz to 1.3 MHz bandwidth
622.08 MHz Clock		188		f _s rms	12 kHz to 5 MHz bandwidth
RF DIVIDER/CML DRIVER EQUIVALENT INTRINSIC TIME JITTER					
F _{IN} = 414.72 MHz, F _{OUT} = 51.84 MHz		136		f _s rms	R = 8, BW = 12 kHz to 400 kHz
F _{IN} = 1244.16 MHz, F _{OUT} = 155.52 MHz		101		f _s rms	R = 8, BW = 12 kHz to 1.3 MHz
F _{IN} = 2488.32 MHz, F _{OUT} = 622.08 MHz		108		f _s rms	R = 4, BW = 12 kHz to 5 MHz
RF DIVIDER/CML DRIVER RESIDUAL PHASE NOISE					
F _{IN} = 81.92 MHz, F _{OUT} = 10.24 MHz					
@ 10 Hz		120		dBc/Hz	RF Divider R = 8
@ 100 Hz		128		dBc/Hz	
@ 1 kHz		137		dBc/Hz	
@ 10 kHz		145		dBc/Hz	
@ 100 kHz		150		dBc/Hz	
≥1 MHz		153		dBc/Hz	
F _{IN} = 983.04 MHz, F _{OUT} = 122.88 MHz					
@ 10 Hz		115		dBc/Hz	RF Divider R = 8
@ 100 Hz		125		dBc/Hz	
@ 1 KHz		132		dBc/Hz	
@ 10 kHz		142		dBc/Hz	
@ 100 kHz		146		dBc/Hz	
@ 1 MHz		151		dBc/Hz	
>3 MHz		153		dBc/Hz	

Parameter	Min	Typ	Max	Unit	Test Conditions/Comments
$F_{IN} = 1966.08 \text{ MHz}$, $F_{OUT} = 491.52 \text{ MHz}$					RF Divider R = 4
@ 10 Hz		105		dBc/Hz	
@ 100 Hz		112		dBc/Hz	
@ 1 kHz		122		dBc/Hz	
@ 10 kHz		130		dBc/Hz	
@ 100 kHz		141		dBc/Hz	
@ 1 MHz		144		dBc/Hz	
>3 MHz		146		dBc/Hz	
$F_{IN} = 2488 \text{ MHz}$, $F_{OUT} = 622 \text{ MHz}$					RF Divider R = 4
@ 10 Hz		100		dBc/Hz	
@ 100 Hz		108		dBc/Hz	
@ 1 kHz		115		dBc/Hz	
@ 10 kHz		125		dBc/Hz	
@ 100 kHz		135		dBc/Hz	
@ 1 MHz		140		dBc/Hz	
$\geq 3 \text{ MHz}$		142		dBc/Hz	
PHASE FREQUENCY DETECTOR/CHARGE PUMP					
REFIN Input					
Input Frequency ²					
÷M Set to Divide by at Least 4			655	MHz	
÷M Bypassed			200	MHz	
Input Voltage Levels	200	450	600	mV p-p	
Input Capacitance			10	pF	
Input Resistance		1500		Ω	
CLK2 Input					
Input Frequency					
÷N Set to Divide by at Least 4			655	MHz	
÷N Bypassed			200	MHz	
Input Voltage Levels	200	450	600	mV p-p	
Input Capacitance			10	pF	
Input Resistance		1500		Ω	
Charge Pump Source/Sink Maximum Current			4	mA	
Charge Pump Source/Sink Accuracy			5	%	
Charge Pump Source/Sink Matching			2	%	
Charge Pump Output Compliance Range ³	0.5		CPVDD – 0.5	V	
STATUS Drive Strength		2		mA	
PHASE FREQUENCY DETECTOR NOISE FLOOR					
@ 50 kHz PFD Frequency		148		dBc/Hz	
@ 2 MHz PFD Frequency		133		dBc/Hz	
@ 100 MHz PFD Frequency		116		dBc/Hz	
@ 200 MHz PFD Frequency		113		dBc/Hz	
RF DIVIDER (CLK1) INPUT SECTION (÷R)					
RF Divider Input Range	1		2700	MHz	DDS SYSCLOCK not to exceed 400 MSPS
Input Capacitance (DC)		3		pF	
Input Impedance (DC)		1500		Ω	
Input Duty Cycle	42	50	58	%	
Input Power/Sensitivity	-10		+4	dBm	Single-ended, into a 50 Ω load ⁴
Input Voltage Level	200		1000	mV p-p	

AD9540

Parameter	Min	Typ	Max	Unit	Test Conditions/Comments
CML OUTPUT DRIVER (OUT0)					
Differential Output Voltage Swing ⁵		720		mV	50 Ω load to supply, both lines 100 Ω terminated, 5 pF load 100 Ω terminated, 5 pF load
Maximum Toggle Rate	655				
Common-Mode Output Voltage		1.75		V	
Output Duty Cycle	42		58	%	
Output Current					
Continuous ⁶		7.2		mA	
Rising Edge Surge		20.9		mA	
Falling Edge Surge		13.5		mA	
Output Rise Time		250		ps	
Output Fall Time		250		ps	
LOGIC INPUTS (SDI/O, I/O_RESET, RESET, I/O_UPDATE, S0, S1, S2, SYNC_IN)⁷					
V _{IH} , Input High Voltage	2.0			V	
V _{IL} , Input Low Voltage			0.8	V	
I _{INH} , I _{INL} , Input Current		±1	±5	μA	
C _{IN} , Maximum Input Capacitance		3		pF	
LOGIC OUTPUTS (SDO, SYNC_OUT, STATUS)⁸					
V _{OH} , Output High Voltage	2.7			V	
V _{OL} , Output Low Voltage			0.4	V	
I _{OH}	100			μA	
I _{OL}	100			μA	
POWER CONSUMPTION					
Total Power Consumed, All Functions On			400	mW	
I _{AVDD}			85	mA	
I _{DVDD}			45	mA	
I _{DVDD_I/O}			20	mA	
I _{CPVDD}			15	mA	
Power-Down Mode		80		mW	
WAKE-UP TIME (FROM POWER-DOWN MODE)					
Digital Power-Down (CFR1<7>)		12		ns	
DAC Power-Down (CFR2<39>)		7		μs	
RF Divider Power-Down (CFR2<23>)		400		ns	
Clock Driver Power-Down (CFR2<20>)		6		μs	
Charge Pump Full Power-Down (CFR2<4>)		10		μs	
Charge Pump Quick Power-Down (CFR2<3>)		150		ns	
CRYSTAL OSCILLATOR (ON REFIN INPUT)					
Operating Range	20	25	30	MHz	
Residual Phase Noise (@ 25 MHz)					
@ 10 Hz Offset		95		dBc/Hz	
@ 100 Hz Offset		120		dBc/Hz	
@ 1 kHz Offset		140		dBc/Hz	
@ 10 kHz Offset		157		dBc/Hz	
@ 100 kHz Offset		164		dBc/Hz	
>1 MHz Offset		168		dBc/Hz	
DIGITAL TIMING SPECIFICATIONS					
$\overline{\text{CS}}$ to SCLK Setup Time TP _{RE}	6			ns	
Period of SCLK (Write) TS _{CLKW}	40			ns	
Period of SCLK (Read) TS _{CLKR}	400			ns	
Serial Data Setup Time T _{DSU}	6.5			ns	
Serial Data Hold Time T _{DHD}	0			ns	
Data Valid Time T _{DV}	40			ns	

Parameter	Min	Typ	Max	Unit	Test Conditions/Comments
I/O Update to SYNC_CLK Setup Time	7			ns	
PS<2:0> to SYNC_CLK Setup Time	7			ns	
Latencies/Pipeline Delays					
I/O Update to DAC Frequency Change	33			SYSCLK Cycles	
I/O Update to DAC Phase Change	33			SYSCLK Cycles	
PS<2:0> to DAC Frequency Change	29			SYSCLK Cycles	
PS<2:0> to DAC Phase Change	29			SYSCLK Cycles	
I/O Update to CP_OUT Scaler Change	4			SYSCLK Cycles	
I/O Update to Frequency Accumulator Step Size Change	4			SYSCLK Cycles	
DAC OUTPUT CHARACTERISTICS					
Resolution		10		Bits	
Full-Scale Output Current		10	15	mA	
Gain Error	-10		+10	% FS	
Output Offset			0.6	μ A	
Output Capacitance		5		pF	
Voltage Compliance Range	AVDD - 0.50		AVDD + 0.50		
Wideband SFDR (DC to Nyquist)					
10 MHz Analog Out		65		dBc	
40 MHz Analog Out		62		dBc	
80 MHz Analog Out		57		dBc	
120 MHz Analog Out		56		dBc	
160 MHz Analog Out		54		dBc	
Narrow-Band SFDR					
10 MHz Analog Out (± 1 MHz)		83		dBc	
10 MHz Analog Out (± 250 kHz)		85		dBc	
10 MHz Analog Out (± 50 kHz)		86		dBc	
40 MHz Analog Out (± 1 MHz)		82		dBc	
40 MHz Analog Out (± 250 kHz)		84		dBc	
40 MHz Analog Out (± 50 kHz)		87		dBc	
80 MHz Analog Out (± 1 MHz)		80		dBc	
80 MHz Analog Out (± 250 kHz)		82		dBc	
80 MHz Analog Out (± 50 kHz)		86		dBc	
120 MHz Analog Out (± 1 MHz)		80		dBc	
120 MHz Analog Out (± 250 kHz)		82		dBc	
120 MHz Analog Out (± 50 kHz)		84		dBc	
160 MHz Analog Out (± 1 MHz)		80		dBc	
160 MHz Analog Out (± 250 kHz)		82		dBc	
160 MHz Analog Out (± 50 kHz)		84		dBc	
DAC RESIDUAL PHASE NOISE					
19.7 MHz F_{OUT}					
@ 10 Hz Offset		122		dBc/Hz	
@ 100 Hz Offset		134		dBc/Hz	
@ 1 kHz Offset		143		dBc/Hz	
@ 10 kHz Offset		150		dBc/Hz	
@ 100 kHz Offset		158		dBc/Hz	
>1 MHz Offset		160		dBc/Hz	

AD9540

Parameter	Min	Typ	Max	Unit	Test Conditions/Comments
51.84 MHz F_{OUT}					
@ 10 Hz Offset		110		dBc/Hz	
@ 100 Hz Offset		121		dBc/Hz	
@ 1 kHz Offset		135		dBc/Hz	
@ 10 kHz Offset		142		dBc/Hz	
@ 100 kHz Offset		148		dBc/Hz	
> 1 MHz Offset		153		dBc/Hz	
105 MHz Analog Out					
@ 10 Hz Offset		105		dBc/Hz	
@ 100 Hz Offset		115		dBc/Hz	
@ 1 kHz Offset		126		dBc/Hz	
@ 10 kHz Offset		132		dBc/Hz	
@ 100 kHz Offset		140		dBc/Hz	
>1 MHz Offset		145		dBc/Hz	
155.52 MHz Analog Out					
@ 10 Hz Offset		100		dBc/Hz	
@ 100 Hz Offset		112		dBc/Hz	
@ 1 kHz Offset		123		dBc/Hz	
@ 10 kHz Offset		131		dBc/Hz	
@ 100 kHz Offset		138		dBc/Hz	
>1 MHz Offset		144		dBc/Hz	

¹ The SNR of a 14-bit ADC was measured with an ENCODE rate of 105 MSPS and an AIN of 170 MHz. The resultant SNR was known to be limited by the jitter of the clock, not by the noise on the AIN signal. From this SNR value, the jitter affecting the measurement can be back calculated.

² Driving the PLLREF input buffer. The crystal oscillator section of this input stage performs up to only 30 MHz.

³ The charge pump output compliance range is functionally 0.2 V to (CPVDD – 0.2 V). The value listed here is the compliance range for 5% matching.

⁴ The input impedance of the CLK1 input is 1500 Ω . However, to provide matching on the clock line, an external 50 Ω load is used.

⁵ Measured as peak-to-peak between DAC outputs.

⁶ For a 4.02 k Ω resistor from DRV_RSET to GND.

⁷ IBIS models for the digital I/O pins available upon request.

⁸ Assumes a 1 mA load.

LOOP MEASUREMENT CONDITIONS**622 MHz OC-12 Clock**

VCO = Sirenza 190-640T

Reference = Wenzel 500-10116 (30.3 MHz)

Loop Filter = 10 kHz BW, 60° Phase Margin

C1 = 170 nF, R1 = 14.4 Ω , C2 = 5.11 μ F, R2 = 89.3 Ω ,
C3 OmittedCP_OUT = 4 mA (Scaler = $\times 8$) $\div R = 2$, $\div M = 1$, $\div N = 1$ **105 MHz Converter Clock**

VCO = Sirenza 190-845T

Reference = Wenzel 500-10116 (30.3 MHz)

Loop Filter = 10 kHz BW, 45° Phase Margin

C1 = 117 nF, R1 = 28 Ω , C2 = 1.6 μ F, R2 = 57.1 Ω , C3 = 53.4 nFCP_OUT = 4 mA (Scaler = $\times 8$) $\div R = 8$, $\div M = 1$, $\div N = 1$ 

Figure 2. Generic Loop Filter

0489E-033

AD9540

ABSOLUTE MAXIMUM RATINGS

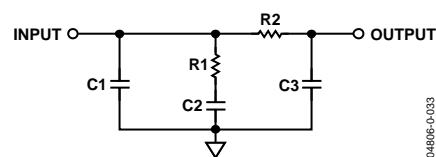
Table 2.

Parameter	Rating
Analog Supply Voltage (AVDD)	2 V
Digital Supply Voltage (DVDD)	2 V
Digital I/O Supply Voltage (DVDD_I/O)	3.6 V
Charge Pump Supply Voltage (CPVDD)	3.6 V
Maximum Digital Input Voltage	-0.5 V to DVDD_I/O + 0.5 V
Storage Temperature	-65°C to +150°C
Operating Temperature Range	-40°C to +125°C
Lead Temperature Range (Soldering 10 sec)	300°C
Junction Temperature	150°C
Thermal Resistance (θ_{JA})	26°C/W

Stresses above those listed under Absolute Maximum Ratings may cause permanent damage to the device. This is a stress rating only; functional operation of the device at these or any other conditions above those indicated in the operational section of this specification is not implied. Exposure to absolute maximum rating conditions for extended periods may affect device reliability.

ESD CAUTION

ESD (electrostatic discharge) sensitive device. Electrostatic charges as high as 4000 V readily accumulate on the human body and test equipment and can discharge without detection. Although this product features proprietary ESD protection circuitry, permanent damage may occur on devices subjected to high energy electrostatic discharges. Therefore, proper ESD precautions are recommended to avoid performance degradation or loss of functionality.



PIN CONFIGURATION AND FUNCTION DESCRIPTIONS

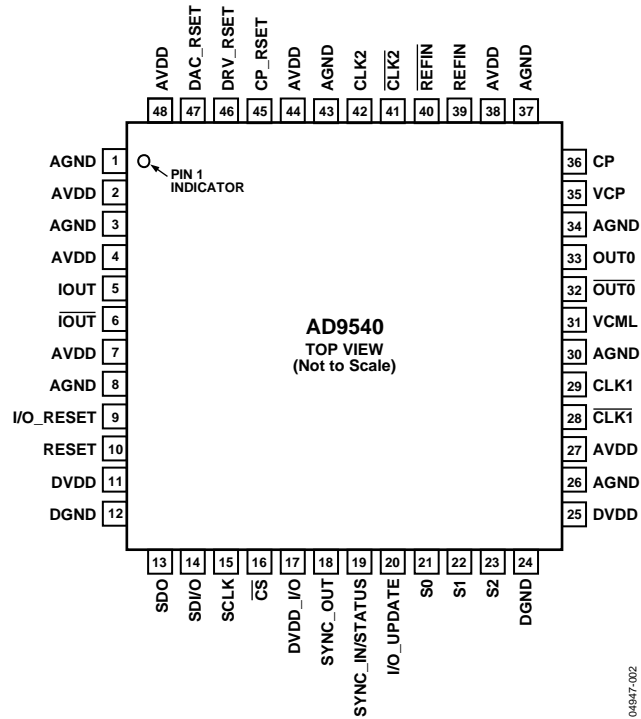

Figure 3. 48-Lead LFCSP Pin Configuration

NOTE: The exposed paddle on this package is an electrical connection (Pin 49) as well as a thermal enhancement. For the device to function properly, the paddle must be attached to analog ground.

AD9540

Table 3. 48-Lead LFCSP Pin Function Descriptions

Pin No.	Mnemonic	Description
1, 3, 8, 26, 30, 34, 37, 43, 49	AGND	Analog Ground.
2, 4, 7, 27, 38, 44, 48	AVDD	Analog Core Supply (1.8 V).
5	IOUT	DAC Analog Output.
6	$\overline{\text{IOUT}}$	DAC Analog Complementary Output.
9	I/O_RESET	Resets the serial port when synchronization is lost in communications but does not reset the device itself (active high). When not being used, this pin should be forced low, because it floats to the threshold value.
10	RESET	Master RESET. Clears all accumulators and returns all registers to their default values (active high).
11, 25	DVDD	Digital Core Supply (1.8 V).
12, 24	DGND	Digital Ground.
13	SDO	Serial Data Output. Used only when device is programmed for 3-wire serial data mode.
14	SDI/O	Serial Data I/O. When the part is programmed for 3-wire serial data mode, this is input only; in 2-wire mode, it serves as both the input and output.
15	SCLK	Serial Data Clock. Provides the clock signal for the serial data port.
16	$\overline{\text{CS}}$	Active Low Signal That Enables Shared Serial Buses. When brought high, the serial port ignores the serial data clocks.
17	DVDD_I/O	Digital Interface Supply (3.3 V).
18	SYNC_OUT	Synchronization Clock Output.
19	SYNC_IN/STATUS	Bidirectional Dual Function Pin. Depending on device programming, this pin is either the DDS's synchronization input (allows alignment of multiple subclocks), or the PLL lock detect output signal.
20	I/O_UPDATE	This input pin, when set high, transfers the data from the I/O buffers to the internal registers on the rising edge of the internal SYNC_CLK, which can be observed on SYNC_OUT.
21, 22, 23	S0, S1, S2	Clock Frequency and Delay Select Pins. Specify one of eight clock frequency/delay profiles.
28	$\overline{\text{CLK1}}$	RF Divider and Internal Clock Input.
29	CLK1	RF Divider and Internal Clock Input.
31	VCML	CML Driver Supply Pin.
32	$\overline{\text{OUT0}}$	CML Driver Complementary Output.
33	OUT0	CML Driver Output.
35	VCP	Charge Pump Supply Pin (3.3 V). To minimize noise on the charge pump, isolate this supply from DVDD_I/O.
36	CP	Charge Pump Output.
39	REFIN	Phase Frequency Detector Reference Input.
40	$\overline{\text{REFIN}}$	Phase Frequency Detector Reference Complementary Input.
41	$\overline{\text{CLK2}}$	Phase Frequency Detector Oscillator (Feedback) Complementary Input.
42	CLK2	Phase Frequency Detector Oscillator (Feedback) Input.
45	CP_RSET	Charge Pump Current Set (Program Charge Pump Current with a Resistor to AGND).
46	DRV_RSET	CML Driver Output Current Set (Program CML Output Current with a Resistor to AGND).
47	DAC_RSET	DAC Output Current Set (Program DAC Output Current with a Resistor to AGND).

NOTE: The exposed paddle on this package is an electrical connection (Pin 49) as well as a thermal enhancement. In order for the device to function properly, the paddle must be attached to analog ground.

TYPICAL PERFORMANCE CHARACTERISTICS

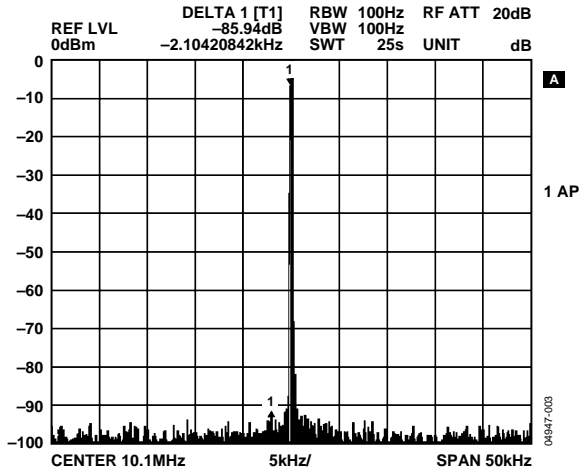

Figure 4. AD9540 DAC Performance: 400 MSPS Clock, 10 MHz F_{OUT} , 50 kHz Span

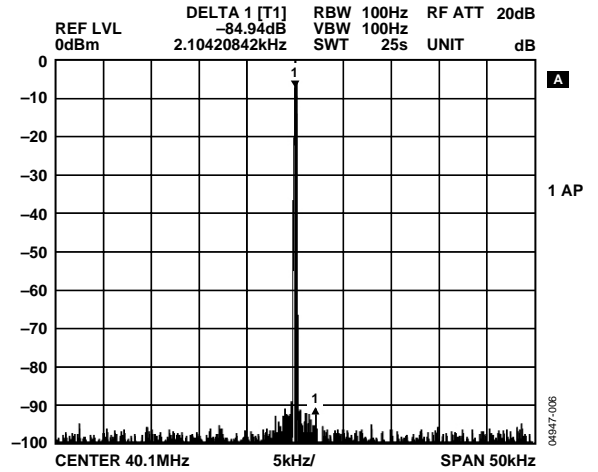

Figure 7. AD9540 DAC Performance: 400 MSPS Clock, 40 MHz F_{OUT} , 50 kHz Span

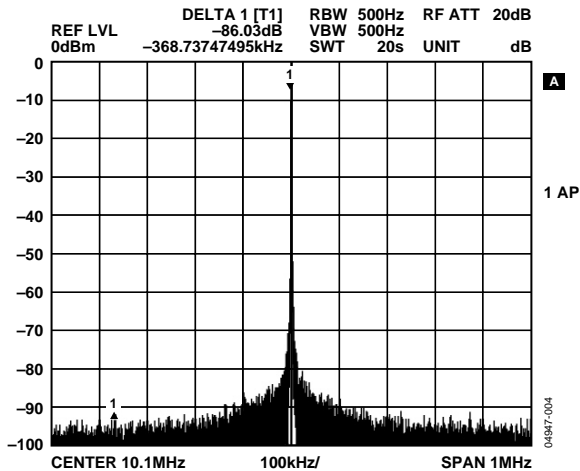

Figure 5. AD9540 DAC Performance: 400 MSPS Clock, 10 MHz F_{OUT} , 1 MHz Span

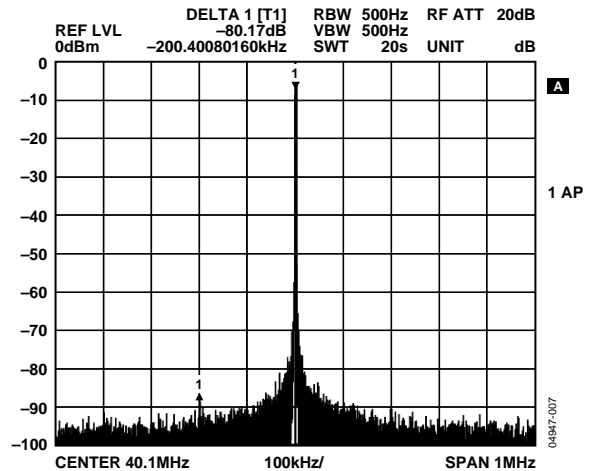

Figure 8. AD9540 DAC Performance: 400 MSPS Clock, 40 MHz F_{OUT} , 1 MHz Span

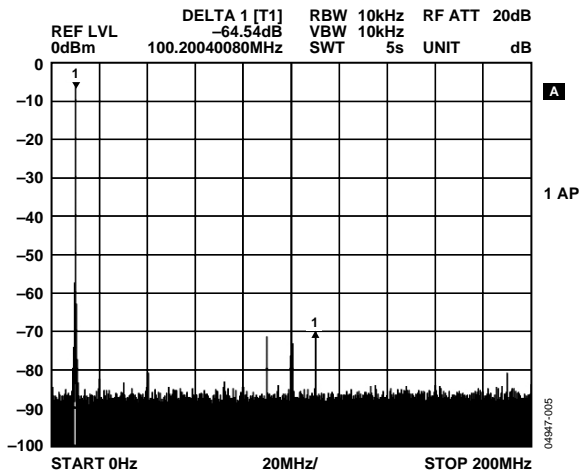

Figure 6. AD9540 DAC Performance: 400 MSPS Clock, 10 MHz F_{OUT} , 200 MHz Span

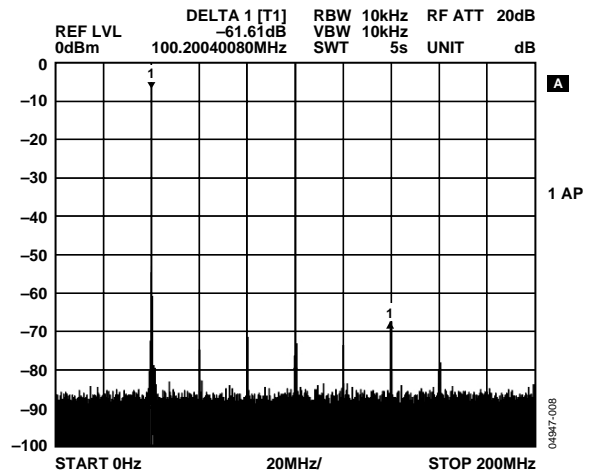

Figure 9. AD9540 DAC Performance: 400 MSPS Clock, 40 MHz F_{OUT} , 200 MHz Span (Nyquist)

AD9540

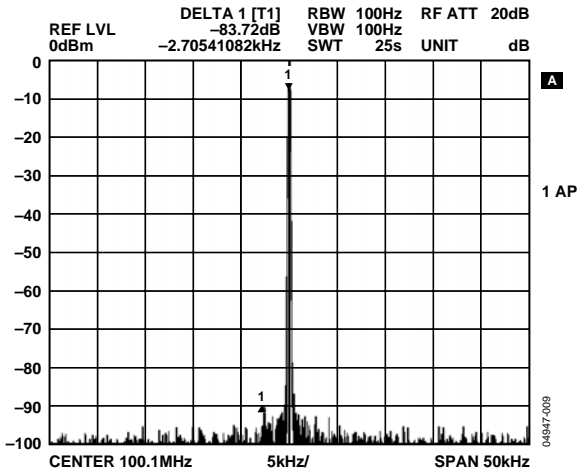

Figure 10. AD9540 DAC Performance: 400 MSPS Clock, 100 MHz F_{OUT} , 50 kHz Span

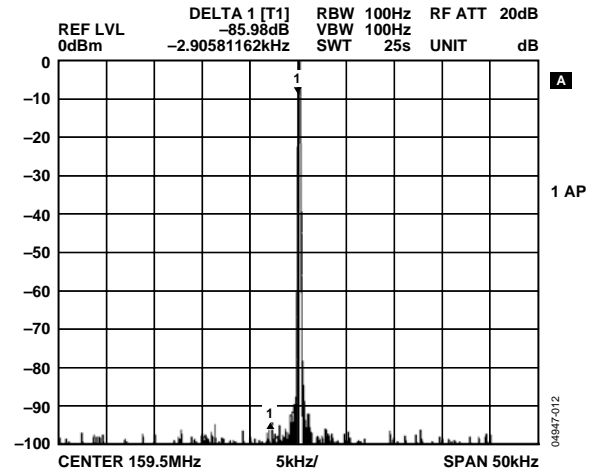

Figure 13. AD9540 DAC Performance: 400 MSPS Clock, 160 MHz F_{OUT} , 50 kHz Span

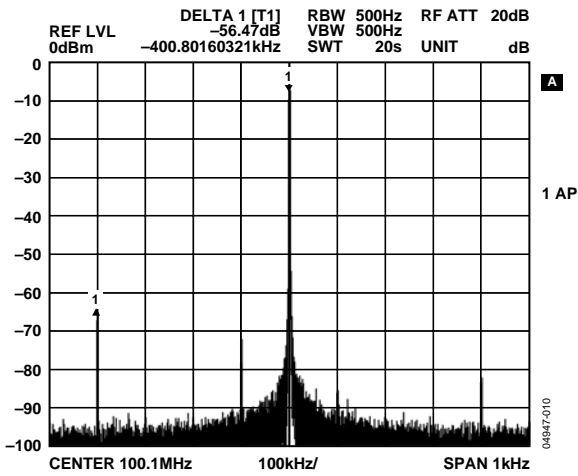

Figure 11. AD9540 DAC Performance: 400 MSPS Clock, 100 MHz F_{OUT} , 1 MHz Span

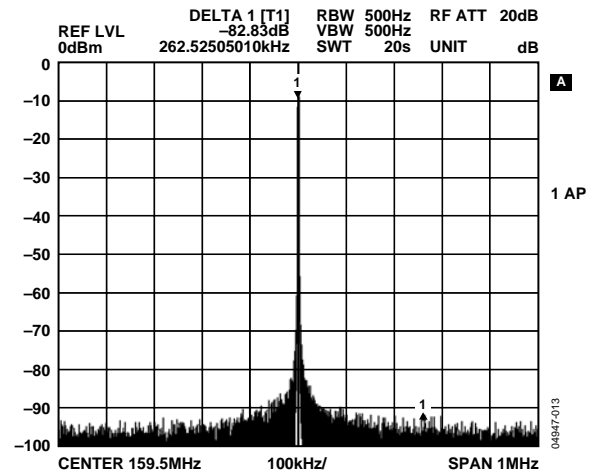

Figure 14. AD9540 DAC Performance: 400 MSPS Clock, 160 MHz F_{OUT} , 1 MHz Span

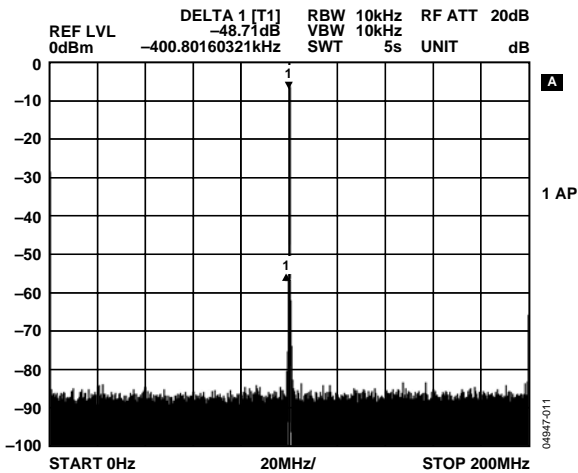

Figure 12. AD9540 DAC Performance: 400 MSPS Clock, 100 MHz F_{OUT} , 200 MHz Span

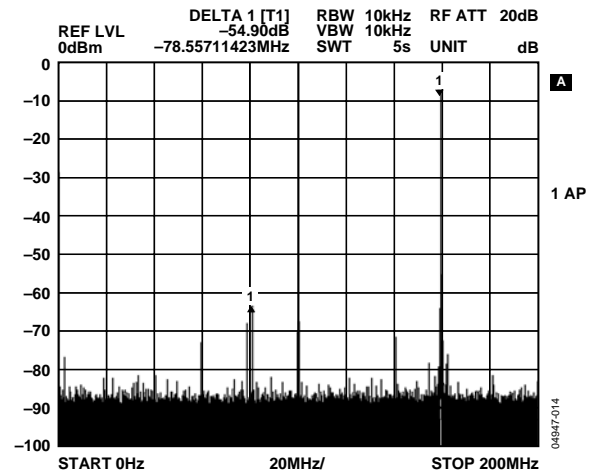

Figure 15. AD9540 DAC Performance: 400 MSPS Clock, 160 MHz F_{OUT} , 200 MHz Span

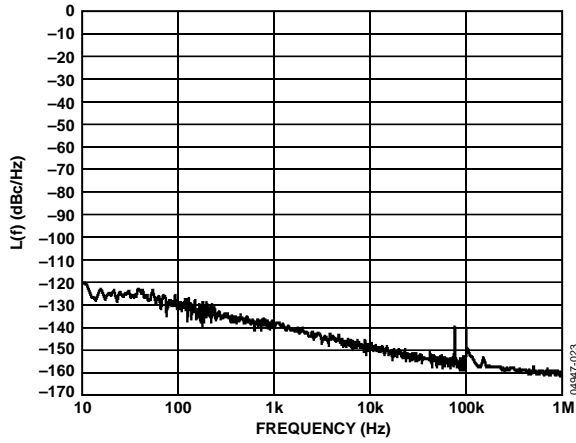

Figure 16. AD9540 DDS/DAC Residual Phase Noise
400 MHz Clock, 19.7 MHz Output

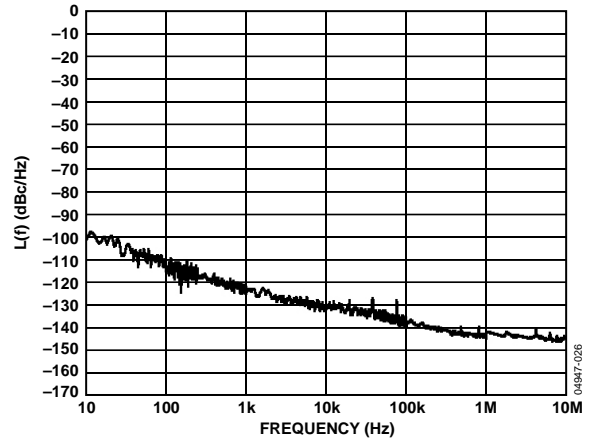

Figure 19. AD9540 DDS/DAC Residual Phase Noise
400 MHz Clock, 155.52 MHz Output

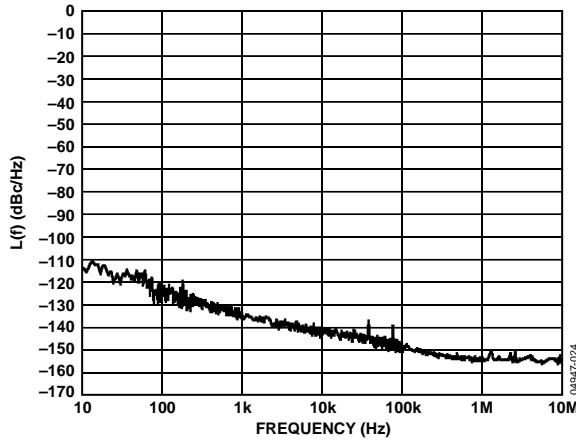

Figure 17. AD9540 DDS/DAC Residual Phase Noise
400 MHz Clock, 51.84 MHz Output

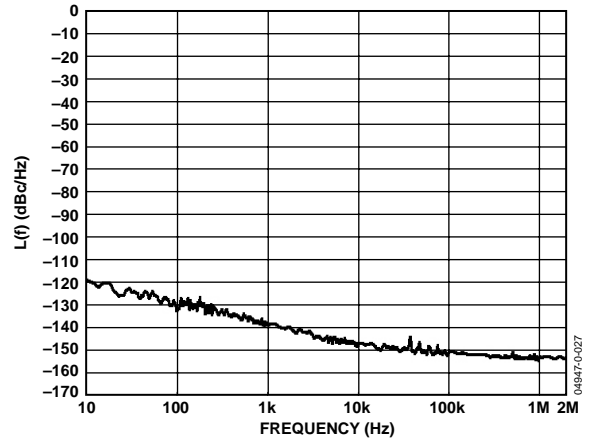

Figure 20. RF Divider and CML Driver Residual
Phase Noise (81.92 MHz In, 10.24 MHz Out)

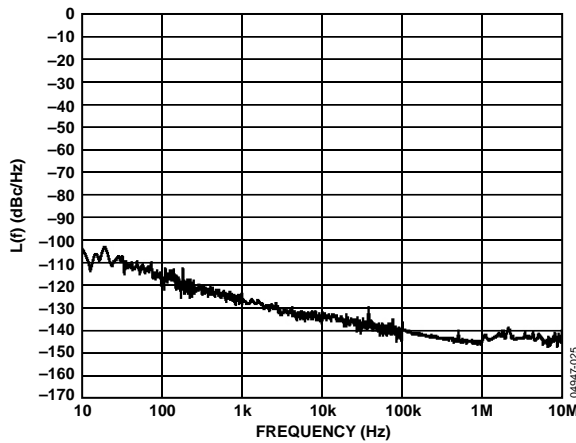

Figure 18. AD9540 DDS/DAC Residual Phase Noise
400 MHz Clock, 105.3 MHz Output

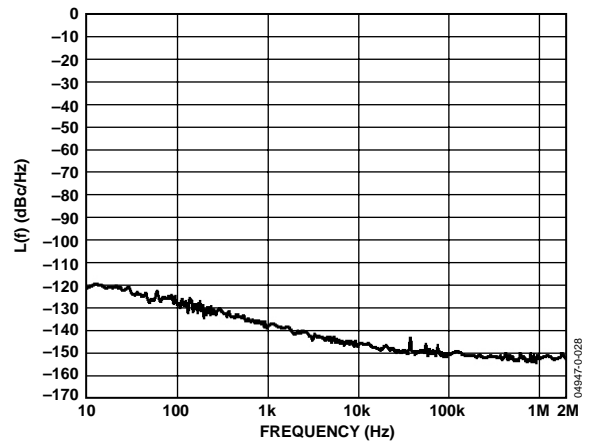

Figure 21. RF Divider and CML Driver Residual
Phase Noise (157.6 MHz In, 19.7 MHz Out)

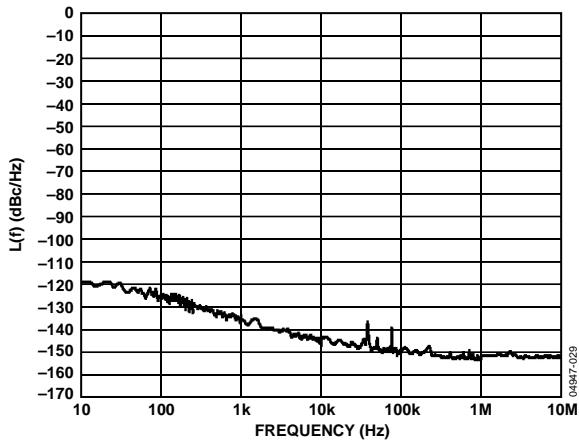

Figure 22. RF Divider and CML Driver Residual Phase Noise (410.4 MHz In, 51.3 MHz Out)

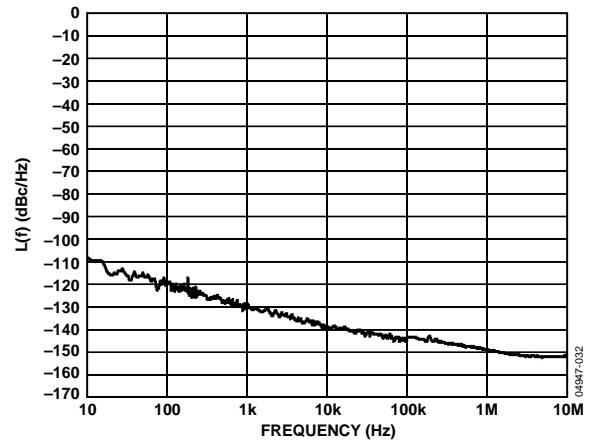

Figure 25. RF Divider and CML Driver Residual Phase Noise (1240 MHz In, 155 MHz Out)

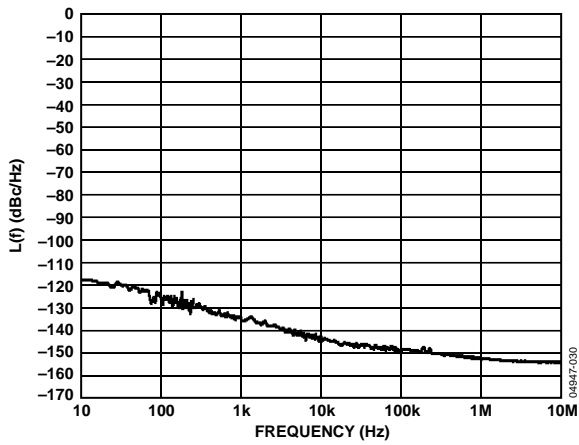

Figure 23. RF Divider and CML Driver Residual Phase Noise (842.4 MHz In, 105.3 MHz Out)

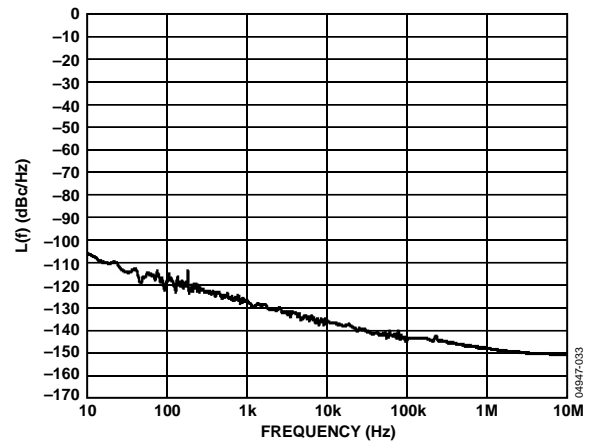

Figure 26. RF Divider and CML Driver Residual Phase Noise (1680 MHz In, 210 MHz Out)

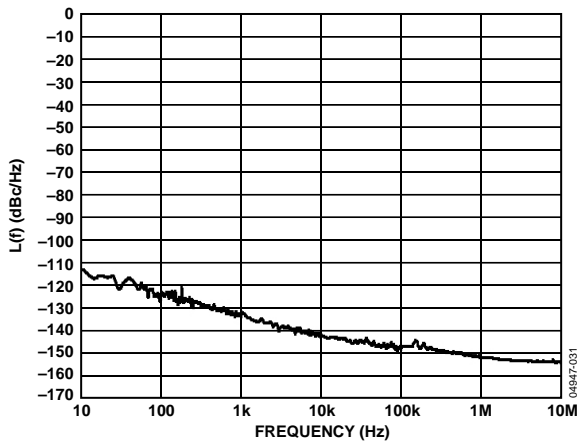

Figure 24. RF Divider and CML Driver Residual Phase Noise (983.04 MHz In, 122.88 MHz Out)

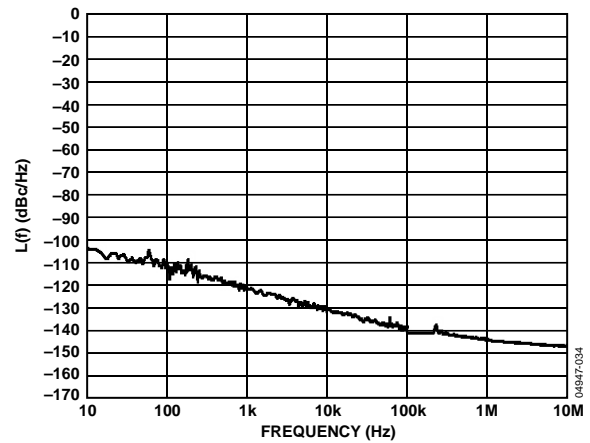

Figure 27. RF Divider and CML Driver Residual Phase Noise (1966.08 MHz In, 491.52 MHz Out)

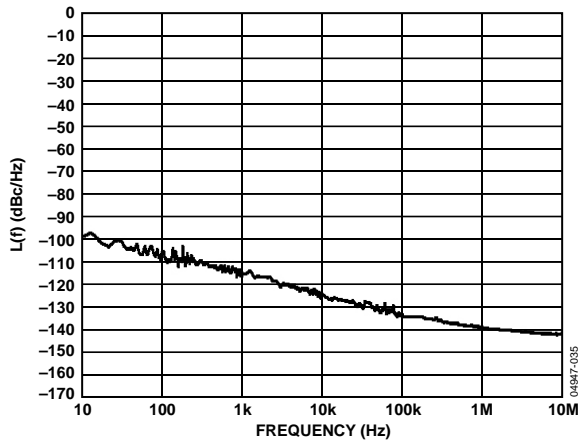

Figure 28. RF Divider and CML Driver Residual Phase Noise (2488 MHz In, 622 MHz Out)

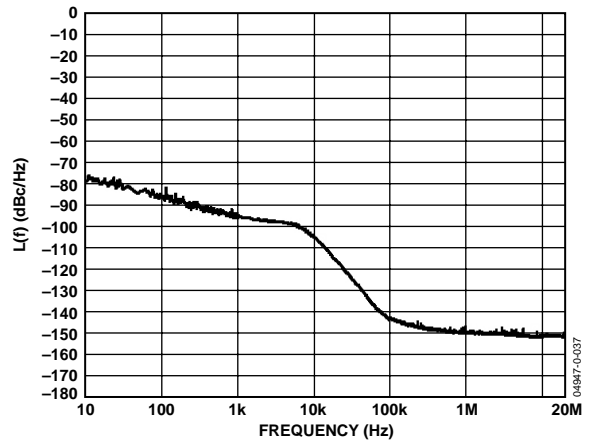

Figure 30. Total System Phase Noise for 210 MHz Converter Clock

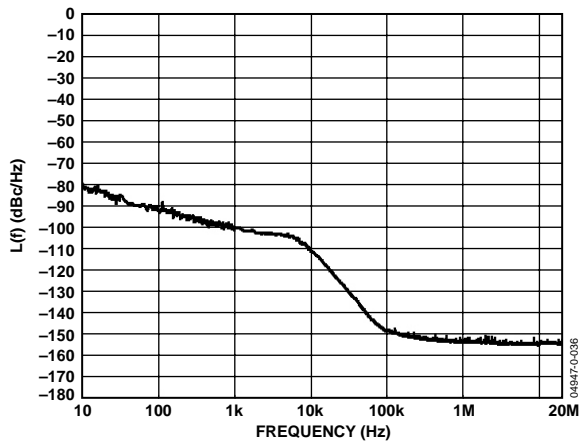

Figure 29. Total System Phase Noise for 105 MHz Converter Clock

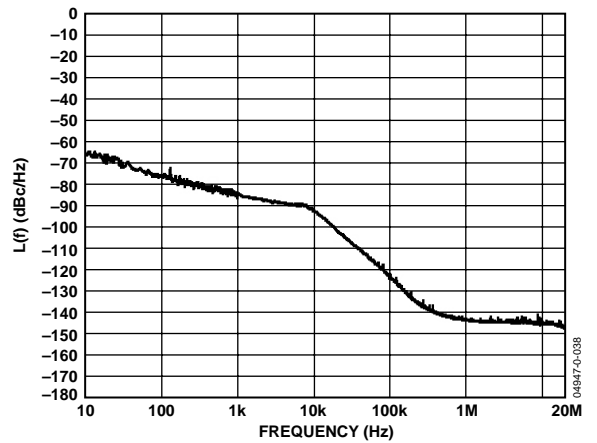

Figure 31. Total System Phase Noise for 622 MHz OC-12 Clock

AD9540

TYPICAL APPLICATION CIRCUITS

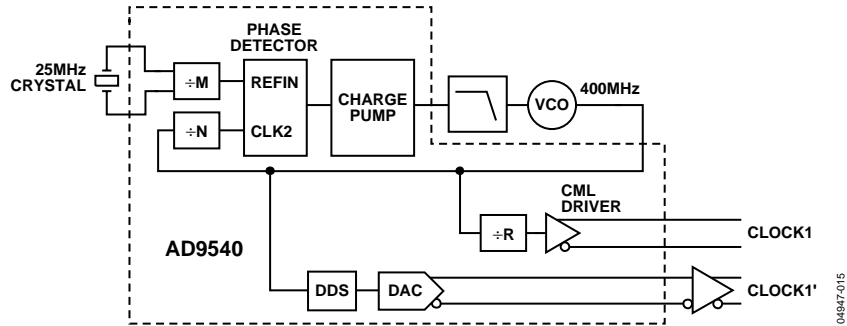

Figure 32. Dual Clock Configuration

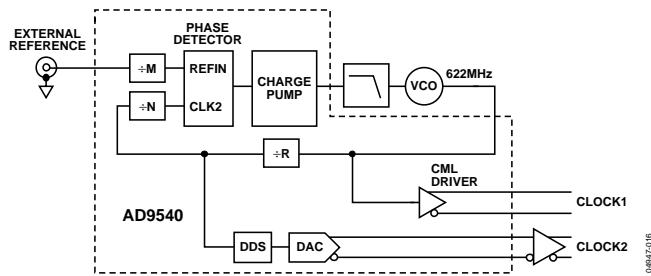

Figure 33. Optical Networking Clock

APPLICATION CIRCUIT DESCRIPTIONS

Dual Clock Configuration: AD9540 Configured in a Dual-Clock Configuration

In this loop, $M = 1$, $N = 16$, and $R = 4$. The DDS tuning word is also equal to $\frac{1}{4}$, so that the frequency of CLOCK 1' equals the frequency of CLOCK 1. Phase adjustments in the DDS provide 14-bit programmable rising edge delay capability of CLOCK 1' with respect to CLOCK 1 (see Figure 32).

Optical Networking Clock: AD9540 Configured as an Optical Networking Clock

The loop can be used to generate a 622 MHz clock for OC12. The DDS can be programmed to output 8 kHz to serve as a base reference for other circuits in the subsystem (see Figure 33).

GENERAL DESCRIPTION

PLL CIRCUITRY

The AD9540 includes an RF divider (divide-by-R), a 48-bit DDS core, a 14-bit programmable delay adjustment, a 10-bit DAC, a phase frequency detector, and a programmable output current charge pump. Incorporating these blocks together, users can generate many useful circuits for clock synthesis. A few simple examples are shown in the Typical Performance Characteristics section.

The RF divider accepts differential or single-ended signals up to 2.7 GHz on the CLK1 input pin. The RF divider also supplies the SYSCLK input to the DDS. Because the DDS operates only up to 400 MSPS, device function requires that for any CLK1 signal > 400 MHz, the RF divider must be engaged. The RF divider can be programmed to take values of 1, 2, 4, or 8. The ratio for the divider is programmed in the control register. The output of the divider can be routed to the input of the on-chip CML driver. For lower frequency input signals, it is possible to use the divider to divide the input signal to the CML driver and to use the undivided input of the divider as the SYSCLK input to the DDS, or vice versa. In all cases, the clock to the DDS should not exceed 400 MSPS.

The on-chip phase frequency detector has two differential inputs, REFIN (the reference input) and CLK2 (the feedback or oscillator input). These differential inputs can be driven by single-ended signals. When doing so, tie the unused input through a 100 pF capacitor to the analog supply (AVDD). The maximum speed of the phase frequency detector inputs is 200 MHz. Each of the inputs has a buffer and a divider ($\div M$ on REFIN and $\div N$ on CLK2) that operates up to 655 MHz. If the signal exceeds 200 MHz, the divider must be used. The dividers are programmed through the control registers and take any integer value between 1 and 16.

The REFIN input also has the option of engaging an in-line oscillator circuit. Engaging this circuit means that the REFIN input can be driven with a crystal in the range of $20 \text{ MHz} \leq \text{REFIN} \leq 30 \text{ MHz}$.

The charge pump outputs a current in response to an error signal generated in the phase frequency detector. The output current is programmed through by placing a resistor (CP_RSET) from the CP_RSET pin to ground. The value is dictated by:

$$CP_IOUT = \frac{1.55}{CP_RSET}$$

This sets the charge pump's reference output current. Also, a programmable scaler multiplies this base value by any integer from 1 to 8, programmable through the CP current scale bits in the Control Function Register 2, CFR2<2:0>.

CML DRIVER

An on-chip current mode logic (CML) driver is also included. This CML driver generates very low jitter clock edges. The outputs of the CML driver are current outputs that drive PECL levels when terminated into a 100Ω load. The continuous output current of the driver is programmed by attaching a resistor from the DRV_RSET pin to ground (nominally $4.02 \text{ k}\Omega$ for a continuous current of 7.2 mA). An optional on-chip current programming resistor is enabled by setting a bit in the control register. The rising edge and falling edge slew rates are independently programmable to help control overshoot and ringing by the application of surge current during rising edge and falling edge transitions (see Figure 34). There is a default surge current of 7.6 mA on the rising edge and of 4.05 mA on the falling edge. Bits in the control register enable additional rising edge and falling edge surge current, as well disable the default surge current (see the Control Function Register Descriptions section for details). The CML driver can be driven by:

- RF divider input (CLK1 directly to the CML driver)
- RF divider output
- CLK2 input

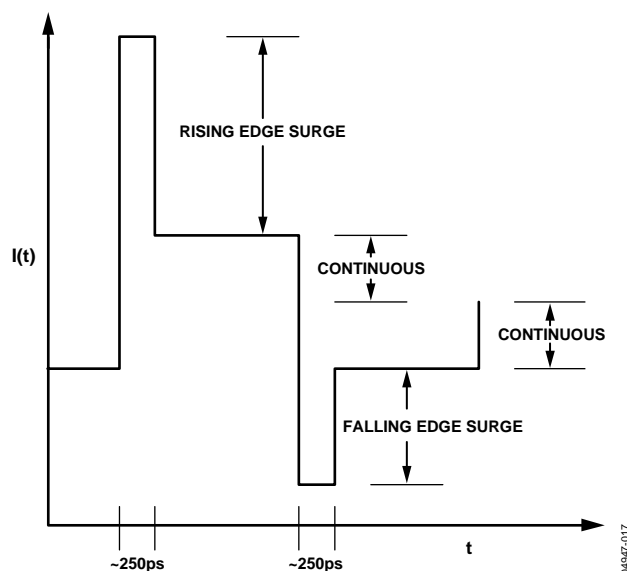

Figure 34. Rising Edge and Falling Edge Surge Current Out of the CML Clock Driver, as Opposed to the Steady State Continuous Current

AD9540

DDS AND DAC

The precision frequency division within the device is accomplished using DDS technology. The DDS can control the digital phase relationships by clocking a 48-bit accumulator. The incremental value loaded into the accumulator, known as the frequency tuning word, controls the overflow rate of the accumulator. Similar to a sine wave completing a 2π radian revolution, the overflow of the accumulator is cyclical in nature and generates a fundamental frequency according to

$$f_o = \frac{FTW \times (f_s)}{2^{48}} \quad \{0 \leq FTW \leq 2^{47}\}$$

The instantaneous phase of the sine wave is therefore the output of the phase accumulator block. This signal may be phase-offset by programming an additive digital phase that is added to each phase sample coming out of the accumulator.

These instantaneous phase values are then piped through a phase-to-amplitude conversion (sometimes called an angle-to-amplitude conversion or AAC) block. This algorithm follows a $\cos(x)$ relationship, where x is the phase coming out of the phase offset block, normalized to 2π .

Finally, the amplitude words are piped to a 10-bit DAC. Because the DAC is a sampled data system, the output is a reconstructed sine wave that needs to be filtered to take high frequency images out of the spectrum. The DAC is a current steering DAC that is AVDD referenced. To get a measurable voltage output, the DAC outputs must be terminated through a load resistor to AVDD, typically 50Ω . At positive full scale, IOUT sinks no current and the voltage drop across the load resistor is 0. However, the $\overline{\text{IOUT}}$ output sinks the DAC's programmed full-scale output current, causing the maximum output voltage drop across the load resistor. At negative full-scale, the situation is reversed and IOUT sinks the full-scale current (and generates the maximum drop across the load resistor), while $\overline{\text{IOUT}}$ sinks no current (and generates no voltage drop). At midscale, the outputs sink equal amounts of current, generating equal voltage drops.

MODES OF OPERATION

SELECTABLE CLOCK FREQUENCIES AND SELECTABLE EDGE DELAY

Because the precision driver is implemented using a DDS, it is possible to store multiple clock frequency words to enable externally switchable clock frequencies. The phase accumulator runs at a fixed frequency, according to the active profile's clock frequency word. Likewise, any delay applied to the rising and falling edges is a static value that comes from the delay shift word of the active profile. The device has eight different phase/frequency profiles, each with its own 48-bit clock frequency word and 14-bit delay shift word. Profiles are selected by applying their digital value on the clock select (S0, S1, and S2) pins. It is not possible to use the phase offset of one profile and the frequency tuning word of another.

SYNCHRONIZATION MODES FOR MULTIPLE DEVICES

In a DDS system, the SYNC_CLK is derived internally from the master system clock, SYSCLK, with a $\div 4$ divider. Because the divider does not power up to a known state, multiple devices in a system might have staggered clock phase relationships, because each device can potentially generate the SYNC_CLK rising edge from any one of four rising edges of SYSCLK. This ambiguity can be resolved by employing digital synchronization logic to control the phase relationships of the derived clocks among different devices in the system. Note that the synchronization functions included on the AD9540 control only the timing relationships among different digital clocks. They do not compensate for the analog timing delay on the system clock due to mismatched phase relationships on the input clock, CLK1 (see Figure 35).

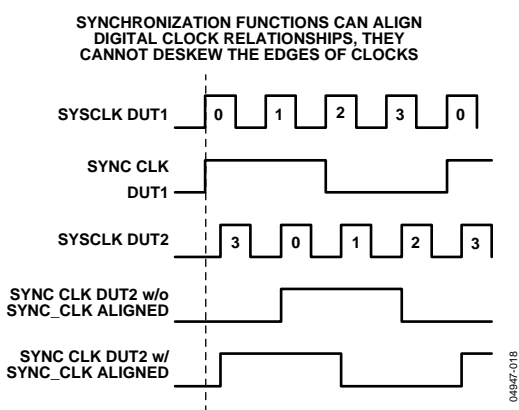

Figure 35. Synchronization Functions: Capabilities and Limitations

Automatic Synchronization

In automatic synchronization mode, the device is placed in slave mode and automatically aligns the internal SYNC_CLK to a master SYNC_CLK signal, supplied on the SYNC_IN input. When this bit is enabled, the STATUS is not available as an output; however, an out-of-lock condition can be detected by reading Control Function Register 1 and checking the status of the STATUS_Error bit. The automatic synchronization function is enabled by setting the Control Function Register 1 automatic synchronization bit, CFR1<3>. To employ this function at higher clock rates (SYNC_CLK > 62.5 MHz, SYSCLK > 250 MHz), the high speed sync enable bit (CFR1<0>) should be set as well.

Manual Synchronization, Hardware Controlled

In this mode, the user controls the timing relationship of the SYNC_CLK with respect to SYSCLK. When hardware manual synchronization is enabled, the SYNC_IN/ STATUS pin becomes a digital input. For each rising edge detected on the SYNC_IN input, the device advances the SYNC_IN rising edge by one SYSCLK period. When this bit is enabled, the STATUS is not available as an output; however, an out-of-lock condition can be detected by reading Control Function Register 1 and checking the status of the STATUS_Error bit. This synchronization function is enabled by setting the hardware manual synchronization enable bit, CFR1<1>.

Manual Synchronization, Software Controlled

In this mode, the user controls the timing relationship between SYNC_CLK and SYSCLK through software programming. When the software manual synchronization bit (CFR1<2>) is set high, the SYNC_CLK is advanced by one SYSCLK cycle. Once this operation is complete, the bit is cleared. The user can set this bit repeatedly to advance the SYNC_CLK rising edge multiple times. Because the operation does not use the SYNC_IN/ STATUS pin as a SYNC_IN input, the STATUS signal can be monitored on the STATUS pin during this operation.

SERIAL PORT OPERATION

An AD9540 serial data-port communication cycle has two phases. Phase 1 is the instruction cycle, which is the writing of an instruction byte to the AD9540, coincident with the first eight SCLK rising edges. The instruction byte provides the AD9540 serial port controller with information regarding the data transfer cycle, which is Phase 2 of the communication cycle. The Phase 1 instruction byte defines whether the upcoming data transfer is read or write and the serial address of the register being accessed.

The first eight SCLK rising edges of each communication cycle are used to write the instruction byte into the AD9540. The remaining SCLK edges are for Phase 2 of the communication cycle. Phase 2 is the actual data transfer between the AD9540 and the system controller. The number of bytes transferred during Phase 2 of the communication cycle is a function of the

register being accessed. For example, when accessing Control Function Register 2, which is four bytes wide, Phase 2 requires that four bytes be transferred. If accessing a frequency tuning word, which is six bytes wide, Phase 2 requires that six bytes be transferred. After transferring all data bytes per the instruction, the communication cycle is completed.

At the completion of any communication cycle, the AD9540 serial port controller expects the next eight rising SCLK edges to be the instruction byte of the next communication cycle. All data input to the AD9540 is registered on the rising edge of SCLK. All data is driven out of the AD9540 on the falling edge of SCLK. Figure 36 through Figure 39 are useful in understanding the general operation of the AD9540 serial port.

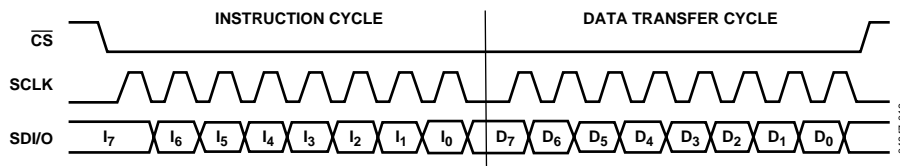

Figure 36. Serial Port Write Timing—Clock Stall Low

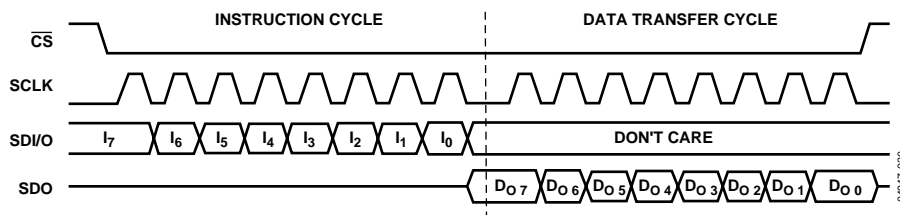

Figure 37. 3-Wire Serial Port Read Timing—Clock Stall Low

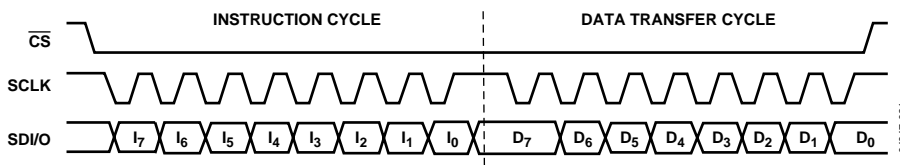

Figure 38. Serial Port Write Timing—Clock Stall High

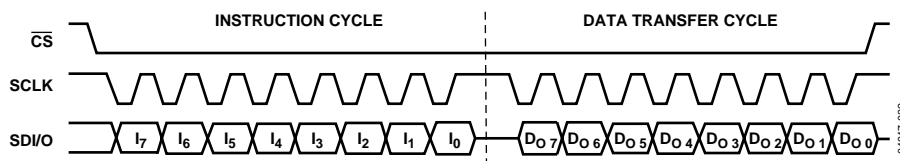

Figure 39. 2-Wire Serial Port Read Timing—Clock Stall High

INSTRUCTION BYTE

The instruction byte contains the following information:

Table 4.

D7	D6	D5	D4	D3	D2	D1	D0
R/Wb	X	X	A4	A3	A2	A1	A0

R/Wb—Bit 7 of the instruction byte determines whether a read or write data transfer occurs after the instruction byte write. Logic 1 indicates a read operation. Logic 0 indicates a write operation.

X, X—Bits 6 and 5 of the instruction byte are Don't Care.

A4, A3, A2, A1, and A0—Bits 4, 3, 2, 1, and 0 of the instruction byte determine which register is accessed during the data transfer portion of the communications cycle.

SERIAL INTERFACE PORT PIN DESCRIPTION

SCLK—Serial Clock. The serial clock pin is used to synchronize data to and from the AD9540 and to run the internal state machines. The SCLK maximum frequency is 25 MHz.

\overline{CS} —Chip Select Bar. \overline{CS} is the active low input that allows more than one device on the same serial communications line. The SDO and SDI/O pins go to a high impedance state when this input is high. If driven high during any communications cycle, that cycle is suspended until \overline{CS} is reactivated low. Chip select can be tied low in systems that maintain control of SCLK.

SDI/O—Serial Data Input/Output. Data is always written to the AD9540 on this pin. However, this pin can be used as a bidirectional data line. CFR1<7> controls the configuration of this pin. The default value (0) configures the SDI/O pin as bidirectional.

SDO—Serial Data Out. Data is read from this pin for protocols that use separate lines for transmitting and receiving data. When the AD9540 operates in a single bidirectional I/O mode, this pin does not output data and is set to a high impedance state.

I/O_RESET—A high signal on this pin resets the I/O port state machines without affecting the addressable registers' contents. An active high input on the I/O_RESET pin causes the current communication cycle to abort. After I/O_RESET returns low (0), another communication cycle can begin, starting with the instruction byte write. Note that when not in use, this pin should be forced low, because it floats to the threshold value.

MSB/LSB TRANSFERS

The AD9540 serial port can support both most significant bit (MSB) first or least significant bit (LSB) first data formats. This functionality is controlled by the LSB first bit in Control Register 1 (CFR1<15>). The default value of this bit is low (MSB first). When CFR1 <15> is set high, the AD9540 serial port is in LSB first format. The instruction byte must be written in the format indicated by CFR1 <15>. If the AD9540 is in LSB first mode, the instruction byte must be written from LSB to MSB. However, the instruction byte phase of the communications cycle still precedes the data transfer cycle.

For MSB first operation, all data written to (read from) the AD9540 are in MSB first order. If the LSB mode is active, all data written to (read from) the AD9540 are in LSB first order.

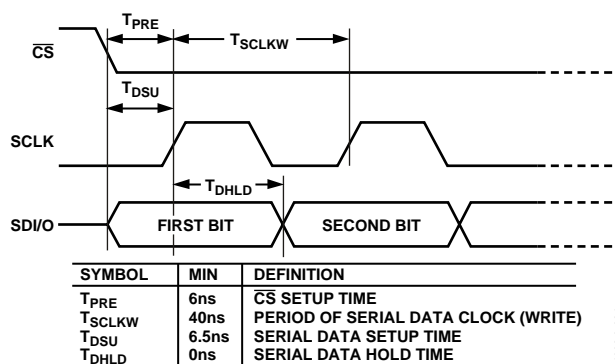

Figure 40. Timing Diagram for Data Write to AD9540

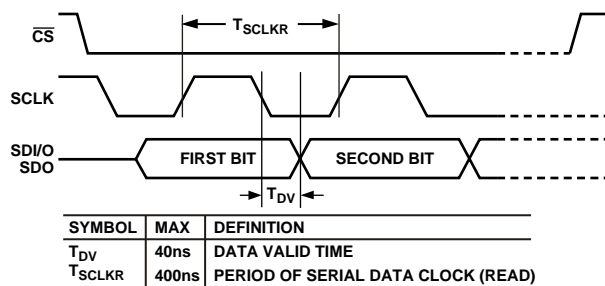

Figure 41. Timing Diagram for Data Read to AD9540

AD9540

REGISTER MAP AND DESCRIPTION

Table 5. Register Map

Register Name (Serial Address)	Bit Range	Bit 7 (MSB)	Bit 6	Bit 5	Bit 4	Bit 3	Bit 2	Bit 1	Bit 0 (LSB)	Default Value/ Profile
Control Function Register 1 (CFR1) (0x00)	<31:24>	Open ¹	Open ¹	Open ¹	Open ¹	Open ¹	Open ¹	Open ¹	STATUS_Error	0x00
	<23:16>	LOAD SRR @ I/O_UPDATE	Auto-Clear Freq. Accum.	Auto-Clear Phase Accum.	Enable Sine Output	Clear Freq. Accum.	Clear Phase Accum.	Open ¹	Open ¹	0x00
	<15:8>	LSB First	SDI/O Input Only	Open ¹	Open ¹	Open ¹	Open ¹	Open ¹	Open ¹	0x00
	<7:0>	Dig. Power-Down	PFD Input Power-Down	REFIN Crystal Enable	SYNC_CLK Out Dis-able	Auto Sync Multiple AD9540s	Software Manual Sync	Hardware Manual Sync	High Speed Sync Enable	0x00
Control Function Register 2 (CFR2) (0x01)	<39:32>	DAC Power-Down	Open ¹	Open ¹	Open ¹	Open ¹	Open ¹	Internal Band Gap Power-Down	Internal CML Driver DRV_RSET	0x00
	<31:24>	Clock Driver Rising Edge <31:29>			Clock Driver Falling Edge Control <28:26>			PLL Lock Detect Enable	PLL Lock Detect Mode	0x00
	<23:16>	RF Divider Power-Down	RF Divider Ratio <22:21>	Clock Driver Power-Down	Clock Driver Input Select <19:18>		Slew Rate Control	RF Div CLK1 Mux Bit	0x78	
	<15:8>	Divider M Control <15:12>				Divider N Control <11:8>				0x00
	<7:0>	Open ¹	Open ¹	CP Polarity	CP Full PD	CP Quick PD	CP Current Scale <2:0>			0x07
	Rising Delta Frequency Tuning Word (RDFTW) (0x02)	<23:16>	Rising Delta Frequency Tuning Word <23:16>							
<15:8>		Rising Delta Frequency Tuning Word <15:8>								0x00
<7:0>		Rising Delta Frequency Tuning Word <7:0>								0x00
Falling Delta Frequency Tuning Word (FDFTW) (0x03)	<23:16>	Falling Delta Frequency Tuning Word <23:16>								0x00
	<15:8>	Falling Delta Frequency Tuning Word <15:8>								0x00
	<7:0>	Falling Delta Frequency Tuning Word <7:0>								0x00
Rising Sweep Ramp Rate (RSRR) (0x04)	<15:8>	Rising Sweep Ramp Rate <15:8>								0x00
	<7:0>	Rising Sweep Ramp Rate <7:0>								0x00
Falling Sweep Ramp Rate (FSRR) (0x05)	<15:8>	Rising Sweep Ramp Rate <15:8>								0x00
	<7:0>	Rising Sweep Ramp Rate <7:0>								0x00

¹ In all cases, Open bits must be written to 0.

Register Name (Serial Address)	Bit Range	Bit 7 (MSB)	Bit 6	Bit 5	Bit 4	Bit 3	Bit 2	Bit 1	Bit 0 (LSB)	Default Value/ Profile
Profile Control Register 0 (PCR0) (0x06)	<63:56>	Open ¹		Phase Offset Word 0 (POW0) <13:8>						0x00
	<55:48>	Phase Offset Word 0 (POW0) <7:0>						0x00		
	<47:40>	Frequency Tuning Word 0 (FTW0) <47:40>						0x00		
	<39:32>	Frequency Tuning Word 0 (FTW0) <39:32>						0x00		
	<31:24>	Frequency Tuning Word 0 (FTW0) <31:24>						0x00		
	<23:16>	Frequency Tuning Word 0 (FTW0) <23:16>						0x00		
	<15:8>	Frequency Tuning Word 0 (FTW0) <15:8>						0x00		
	<7:0>	Frequency Tuning Word 0 (FTW0) <7:0>						0x00		
Profile Control Register 1 (PCR1) (0x07)	<63:56>	Open ¹		Phase Offset Word 1 (POW1) <13:8>						0x00
	<55:48>	Phase Offset Word 1 (POW1) <7:0>						0x00		
	<47:40>	Frequency Tuning Word 1 (FTW1) <47:40>						0x00		
	<39:32>	Frequency Tuning Word 1 (FTW1) <39:32>						0x00		
	<31:24>	Frequency Tuning Word 1 (FTW1) <31:24>						0x00		
	<23:16>	Frequency Tuning Word 1 (FTW1) <23:16>						0x00		
	<15:8>	Frequency Tuning Word 1 (FTW1) <15:8>						0x00		
	<7:0>	Frequency Tuning Word 1 (FTW1) <7:0>						0x00		
Profile Control Register 2 (PCR2) (0x08)	<63:56>	Open ¹		Phase Offset Word 2 (POW2) <13:8>						0x00
	<55:48>	Phase Offset Word 2 (POW2) <7:0>						0x00		
	<47:40>	Frequency Tuning Word 2 (FTW2) <47:40>						0x00		
	<39:32>	Frequency Tuning Word 2 (FTW2) <39:32>						0x00		
	<31:24>	Frequency Tuning Word 2 (FTW2) <31:24>						0x00		
	<23:16>	Frequency Tuning Word 2 (FTW2) <23:16>						0x00		
	<15:8>	Frequency Tuning Word 2 (FTW2) <15:8>						0x00		
	<7:0>	Frequency Tuning Word 2 (FTW2) <7:0>						0x00		
Profile Control Register 3 (PCR3) (0x09)	<63:56>	Open ¹		Phase Offset Word 3 (POW3) <13:8>						0x00
	<55:48>	Phase Offset Word 3 (POW3) <7:0>						0x00		
	<47:40>	Frequency Tuning Word 3 (FTW3) <47:40>						0x00		
	<39:32>	Frequency Tuning Word 3 (FTW3) <39:32>						0x00		
	<31:24>	Frequency Tuning Word 3 (FTW3) <31:24>						0x00		
	<23:16>	Frequency Tuning Word 3 (FTW3) <23:16>						0x00		
	<15:8>	Frequency Tuning Word 3 (FTW3) <15:8>						0x00		
	<7:0>	Frequency Tuning Word 3 (FTW3) <7:0>						0x00		

¹ In all cases, Open bits must be written to 0.

AD9540

Register Name (Serial Address)	Bit Range	Bit 7 (MSB)	Bit 6	Bit 5	Bit 4	Bit 3	Bit 2	Bit 1	Bit 0 (LSB)	Default Value/ Profile
Profile Control Register 4 (PCR4) (0x0A)	<63:56>	Open ¹		Phase Offset Word 4 (POW4) <13:8>						0x00
	<55:48>	Phase Offset Word 4 (POW4) <7:0>								0x00
	<47:40>	Frequency Tuning Word 4 (FTW4) <47:40>								0x00
	<39:32>	Frequency Tuning Word 4 (FTW4) <39:32>								0x00
	<31:24>	Frequency Tuning Word 4 (FTW4) <31:24>								0x00
	<23:16>	Frequency Tuning Word 4 (FTW4) <23:16>								0x00
	<15:8>	Frequency Tuning Word 4 (FTW4) <15:8>								0x00
	<7:0>	Frequency Tuning Word 4 (FTW4) <7:0>								0x00
Profile Control Register 5 (PCR5) (0x0B)	<63:56>	Open ¹		Phase Offset Word 5 (POW5) <13:8>						0x00
	<55:48>	Phase Offset Word 5 (POW5) <7:0>								0x00
	<47:40>	Frequency Tuning Word 5 (FTW5) <47:40>								0x00
	<39:32>	Frequency Tuning Word 5 (FTW5) <39:32>								0x00
	<31:24>	Frequency Tuning Word 5 (FTW5) <31:24>								0x00
	<23:16>	Frequency Tuning Word 5 (FTW5) <23:16>								0x00
	<15:8>	Frequency Tuning Word 5 (FTW5) <15:8>								0x00
	<7:0>	Frequency Tuning Word 5 (FTW5) <7:0>								0x00
Profile Control Register 6 (PCR6) (0x0C)	<63:56>	Open ¹		Phase Offset Word 6 (POW6) <13:8>						0x00
	<55:48>	Phase Offset Word 6 (POW6) <7:0>								0x00
	<47:40>	Frequency Tuning Word 6 (FTW6) <47:40>								0x00
	<39:32>	Frequency Tuning Word 6 (FTW6) <39:32>								0x00
	<31:24>	Frequency Tuning Word 6 (FTW6) <31:24>								0x00
	<23:16>	Frequency Tuning Word 6 (FTW6) <23:16>								0x00
	<15:8>	Frequency Tuning Word 6 (FTW6) <15:8>								0x00
	<7:0>	Frequency Tuning Word 6 (FTW6) <7:0>								0x00
Profile Control Register 7 (PCR7) (0x0D)	<63:56>	Open ¹		Phase Offset Word 7 (POW7) <13:8>						0x00
	<55:48>	Phase Offset Word 7 (POW7) <7:0>								0x00
	<47:40>	Frequency Tuning Word 7 (FTW7) <47:40>								0x00
	<39:32>	Frequency Tuning Word 7 (FTW7) <39:32>								0x00
	<31:24>	Frequency Tuning Word 7 (FTW7) <31:24>								0x00
	<23:16>	Frequency Tuning Word 7 (FTW7) <23:16>								0x00
	<15:8>	Frequency Tuning Word 7 (FTW7) <15:8>								0x00
	<7:0>	Frequency Tuning Word 7 (FTW7) <7:0>								0x00

¹ In all cases, Open bits must be written to 0.

CONTROL FUNCTION REGISTER DESCRIPTIONS

Control Function Register 1 (CFR1)

This control register is comprised of four bytes, which must be written during a write operation involving CFR1. CFR1 is used to control various functions, features, and operating modes of the AD9540. The functionality of each bit(s) is described below. In general, the bit is named for the function it serves when the bit is set.

CFR1<31:25> Open

Unused locations. Write a Logic 0.

CFR1<24> STATUS_Error (Read-Only)

When the device is operating in automatic synchronization mode or hardware manual synchronization mode the SYNC_IN/STATUS pin behaves as the SYNC_IN. To determine whether or not the PLL has become unlocked while in synchronization mode, this bit serves as a flag to indicate that an unlocked condition has occurred within the phase frequency detector. Once set, the flag stays high until it is cleared by a readback of the value even though the loop might have relocked. Readback of the CFR1 register clears this bit.

CFR1<24> = 0 indicates that the loop has maintained lock since the last readback.

CFR1<24> = 1 indicates that the loop became unlocked at some point since the last readback of this bit.

CFR1<23> Load Sweep Ramp Rate at I/O_UPDATE, also known as Load SRR @ I/O_UPDATE

The sweep ramp rate is set by entering a value to a down-counter that is clocked by the SYNC_CLK. Each time a new step is taken in the linear sweep algorithm, the ramp rate value is passed from the linear sweep ramp rate register to this down-counter. When set, CFR1<23> enables the user to force the part to restart the countdown sequence for the current linear sweep step by toggling the I/O_UPDATE pin.

CFR1<23> = 0 (default). The linear sweep ramp rate countdown value is loaded only upon completion of a countdown sequence.

CFR1<23> = 1. The linear sweep ramp rate countdown value is reloaded, if an I/O_UPDATE signal is sent to the part during a sweep.

CFR1<22> Auto-Clear Frequency Accumulator

This bit enables the auto-clear function for the frequency accumulator. The auto-clear function serves as a clear and release function for the frequency accumulator (which performs the linear sweep operation) that then begins sweeping from a known value of FTW0.

CFR1 <22> = 0 (default). Issuing an I/O_UPDATE has no effect on the current state of the frequency accumulator.

CFR1 <22> = 1. Issuing an I/O_UPDATE signal to the part clears the current contents of the frequency accumulator for one sync-clock period.

CFR1 <21> Auto-Clear Phase Accumulator

This bit enables the auto-clear function for the phase accumulator. The auto-clear function serves as a reset function for the phase accumulator, which then begins accumulating from a known phase value of 0.

CFR1<21> = 0 (default). Issuing an I/O_UPDATE has no effect on the current state of the phase accumulator.

CFR1<21> = 1. Issuing an I/O_UPDATE clears the current contents of the phase accumulator for one SYNC_CLK period.

CFR1 <20> Enable Sine Output

Two different trigonometric functions can be used to convert the phase angle to an amplitude value, cosine or sine. This bit selects the function used.

CFR1<20> = 0 (default). The phase-to-amplitude conversion block uses a cosine function.

CFR1<20> = 1. The phase-to-amplitude conversion block uses a sine function.

CFR1 <19> Clear Frequency Accumulator

This bit serves as a static-clear, or a clear-and-hold bit for the frequency accumulator. It prevents the frequency accumulator from incrementing the value as long as it is set.

CFR1 <19> = 0 (default). The frequency accumulator operates normally.

CFR1 <19> = 1. The frequency accumulator is cleared and held at 0.

CFR1 <18> Clear Phase Accumulator

This bit serves as a static clear, or a clear-and-hold bit for the phase accumulator. It prevents the phase accumulator from incrementing the value as long as it is set.

CFR1 <18> = 0 (default). The phase accumulator operates normally.

CFR1 <18> = 1. The phase accumulator is cleared and held at 0.

CFR1 <17:16> Open

Unused locations. Write a Logic 0.

AD9540

CFR1<15> LSB First Serial Data Mode

The serial data transfer to the device can be either MSB first or LSB first. This bit controls that operation.

CFR1<15> = 0 (default). Serial data transfer to the device is in MSB first mode.

CFR1<15> = 1. Serial data transfer to the device is in LSB first mode.

CFR1<14> SDI/O Input Only (3-Wire Serial Data Mode)

The serial port on the AD9540 can act in 2-wire mode (SCLK and SDI/O) or 3-wire mode (SCLK, SDI/O, and SDO). This bit toggles the serial port between these two modes.

CFR1<14> = 0 (default). Serial data transfer to the device is in 2-wire mode. The SDI/O pin is bidirectional.

CFR1<14> = 1. Serial data transfer to the device is in 3-wire mode. The SDI/O pin is input only.

CFR1<13:8> Open

Unused locations. Write a Logic 0.

CFR1<7> Digital Power-Down

This bit powers down the digital circuitry not directly related to the I/O port. The I/O port functionality is not suspended, regardless of the state of this bit.

CFR1<7> = 0 (default). Digital logic operating as normal.

CFR1<7> = 1. All digital logic not directly related to the I/O port is powered down. Internal digital clocks are suspended.

CFR1<6> Phase Frequency Detector Input Power-Down

This bit controls the input buffers on the phase frequency detector. It provides a way to gate external signals from the phase frequency detector.

CFR1<6> = 0 (default). Phase frequency detector input buffers are functioning normally.

CFR1<6> = 1. Phase frequency detector input buffers are powered down, isolating the phase frequency detector from the outside world.

CFR1<5> REFIN Crystal Enable

The AD9540 phase frequency detector has an on-chip oscillator circuit. When enabled, the reference input to the phase frequency detector (REFIN/PLLREF) can be driven by a crystal.

CFR1<5> = 0 (default). The phase frequency detector reference input operates as a standard analog input.

CFR1<5> = 1. The reference input oscillator circuit is enabled, allowing the use of a crystal for the reference of the phase frequency detector.

CFR1<4> SYNC_CLK Disable

If synchronization of multiple devices is not required, the spectral energy resulting from this signal can be reduced by gating the output buffer off. This function gates the internal clock reference SYNC_CLK ($\text{SYSCLK} \div 4$) off of the SYNC_OUT pin.

CFR1<4> = 0 (default). The SYNC_CLK signal is present on the SYNC_OUT pin and is ready to be ported to other devices.

CFR1<4> = 1. The SYNC_CLK signal is gated off, putting the SYNC_OUT pin into a high impedance state.

CFR1<3> Automatic Synchronization

One of the synchronization modes of the AD9540 forces the DDS core to derive the internal reference from an external reference supplied on the SYNC_IN pin. For details on synchronization modes for the DDS core, see the Synchronization Modes for Multiple Devices section.

CFR1<3> = 0 (default). The automatic synchronization function of the DDS core is disabled.

CFR1<3> = 1. The automatic synchronization function is on. The device is slaved to an external reference and adjusts the internal SYNC_CLK to match the external reference, which is supplied on the SYNC_IN input.

CFR1<2> Software Manual Synchronization

Rather than relying on the part to automatically synchronize the internal clocks, the user can program the part to advance the internal SYNC_CLK one system clock cycle. This bit is self-clearing and can be set multiple times.

CFR1<2> = 0 (default). The SYNC_CLK stays in the current timing relationship to SYSCLK.

CFR1<2> = 1. The SYNC_CLK advances the rising and falling edges by one SYSCLK cycle. This bit is then self-cleared.

CFR1<1> Hardware Manual Synchronization

Similar to the software manual synchronization (CFR1<2>), this function enables the user to advance the SYNC_CLK rising edge by one system clock period. This bit enables the SYNC_IN/STATUS pin as a digital input. Once enabled, every rising edge on the SYNC_IN input advances the SYNC_CLK by one SYCLK period. While enabled, the STATUS signal is not available on an external pin. However, loop out-of-lock events trigger a flag in the control register (CFR1<24>).

CFR1<1> = 0 (default). The hardware manual synchronization function is disabled. Either the part is outputting the STATUS (CFR1<3> = 0) or it is using the SYNC_IN to slave the SYNC_CLK signal to an external reference provided on SYNC_IN (CFR1<3> = 1).

CFR1<1> = 1. The SYNC_IN/STATUS pin is set as a digital input. Each subsequent rising edge on this pin advances the SYNC_CLK rising edge by one SYSCLK period.

CFR1<0> High Speed Synchronization Enable Bit

This bit enables extra functionality in the auto synchronization algorithm, which enables the device to synchronize high speed clocks (SYNC_CLK > 62.5 MHz).

CFR1<0> = 0 (default). High speed synchronization is disabled.

CFR1<0> = 1. High speed synchronization is enabled.

Control Function Register 2 (CFR2)

The Control Register 2 is comprised of five bytes, which must be written during a write operation involving CFR2. With some minor exceptions, the CFR2 primarily controls analog and timing functions on the AD9540.

CFR2<39> DAC Power-Down Bit

This bit powers down the DAC portion of the AD9540 and puts it into the lowest power dissipation state.

CFR2<39> = 0 (default). DAC is powered on and operating.

CFR2<39> = 1. DAC is powered down and the output is in a high impedance state.

CFR2<38:34> Open

Unused locations. Write a Logic 0.

CFR2<33> Internal Band Gap Power-Down

To shut off all internal quiescent current, the band gap needs to be powered down. This is normally not done because it takes a long time (~10 ms) for the band gap to power up and settle to its final value.

CFR2<33> = 0. Even when all other sections are powered down, the band gap is powered up and is providing a regulated voltage.

CFR2<33> = 1. The band gap is powered down.

CFR2<32> Internal CML Driver DRV_RSET

To program the CML driver's output current, a resistor must be placed between the DRV_RSET pin and ground. This bit enables an internal resistor to program the output current of the driver.

CFR2<32> = 0 (default). The DRV_RSET pin is enabled, and an external resistor must be attached to the CP_RSET pin to program the output current.

CFR2<32> = 1. The CML current is programmed by the internal resistor and ignores the resistor on the DRV_RSET pin.

CFR2<31:29> Clock Driver Rising Edge

These bits control the slew rate of the CML clock driver output's rising edge. When these bits are on, additional current is sent to the output driver to increase the rising edge slew rate capability. Table 6 describes how the bits increase the current. Note that the additional current is on only during the rising edge of the waveform for approximately 250 ps, not during the entire transition.

Table 6. CML Clock Driver Rising Edge Slew Rate Control Bits and Associated Surge Current

CFR2<31> = 1	7.6 mA
CFR2<30> = 1	3.8 mA
CFR2<29> = 1	1.9 mA

CFR2<28:26> Clock Driver Falling Edge Control

These bits control the slew rate of the CML clock driver output's falling edge. When these bits are on, additional current is sent to the output driver to increase the rising edge slew rate capability. Table 7 describes how the bits increase the current. Note that the additional current is on only during the rising edge of the waveform, for approximately 250 ps, not during the entire transition.

Table 7. CML Clock Drive Falling Edge Slew Rate Control Bits and Associated Surge Current

CFR2<28> = 1	5.4 mA
CFR2<30> = 1	2.7 mA
CFR2<29> = 1	1.35 mA

CFR2<25> PLL Lock Detect Enable

This bit enables the SYNC_IN/STATUS pin as a lock detect output for the PLL.

CFR2<25> = 0 (default). The STATUS_DETECT signal is disabled.

CFR2<25> = 1. The STATUS_DETECT signal is enabled.

CFR2<24> PLL Lock Detect Mode

This bit toggles the modes of the PLL lock detect function. The lock detect can either be a status indicator (locked or unlocked) or it can indicate a lead-lag relationship between the two phase frequency detector inputs.

AD9540

CFR2<24> = 0 (default). The lock detect acts as a status indicator (PLL is locked 0 or unlocked 1).

CFR2<24> = 1. The lock detect acts as a lead-lag indicator. A 1 on the STATUS pin means that the CLK2 pin lags the reference. A 0 means that the CLK2 pin leads the reference.

CFR2<23> RF Divider Power-Down

This bit powers down the RF divider to save power when not in use.

CFR2<23> = 0 (default). The RF divider is on.

CFR2<23> = 1. The RF divider is powered down and an alternate path between the CLK1 inputs and SYSCLK is enabled.

CFR2<22:21> RF Divider Ratio

These two bits control the RF divider ratio ($\div R$).

CFR2<22:21> = 11 (default). RF Divider R = 8.

CFR2<22:21> = 10. RF Divider R = 4.

CFR2<22:21> = 01. RF Divider R = 2.

CFR2<22:21> = 00. RF Divider R = 1. Note that this is not the same as bypassing the RF divider.

CFR2<20> Clock Driver Power-Down

This bit powers down the CML clock driver circuit.

CFR2<20> = 1 (default). The CML clock driver circuit is powered down.

CFR2<20> = 0. The CML clock driver is powered up.

CFR2<19:18> Clock Driver Input Select

These bits control the mux on the input for the CML clock driver.

CFR2<19:18> = 00. The CML clock driver is disconnected from all inputs (and does not toggle).

CFR2<19:18> = 01. The CML clock driver is driven by the CLK2 input pin.

CFR2<19:18> = 10 (default). The CML clock driver is driven by the output of the RF divider.

CFR2<19:18> = 11. The CML clock driver is driven by the input of the RF divider

CFR2<17> Slew Rate Control Bit

Even without the additional surge current supplied by the rising edge slew rate control bits and the falling edge slew rate control bits, the device applies a default 7.6 mA surge current to the

rising edge and a 4.05 mA surge current to the falling edge. This bit disables all slew rate enhancement surge current, including the default values.

CFR2<17> = 0 (default). The CML driver applies default surge current to rising and falling edges.

CFR2<17> = 1. Driver applies no surge current during transitions. The only current is the continuous current.

CFR2<16> RF Divider CLK1 Mux

This bit toggles the mux to control whether the RF divider output or input is supplying SYSCLK to the device.

CFR2<16> = 0 (default). The RF divider output supplies the DDS SYSCLK.

CFR2<16> = 1. The RF divider input supplies the DDS SYSCLK (bypass the divider). Note that regardless of the condition of the configuration of the clock input, the DDS SYSCLK must not exceed the maximum rated clock speed.

CFR2<15:12> REFIN Divider ($\div M$) Control Bits

These four bits set the REFIN divider ($\div M$) ratio where M is a value = 1 to 16 and CFR2<15:12> = 0000 means that M = 1 and CFR2<15:12> = 1111 means that M = 16 or simply, M = CFR2<15:12> + 1.

Table 8. REFIN Divider Values ($\div M$)

CFR2<15:12> =	M =	CFR2<15:12> =	M =
0000	1	1000	9
0001	2	1001	10
0010	3	1010	11
0011	4	1011	12
0100	5	1100	13
0101	6	1101	14
0110	7	1110	15
0111	8	1111	16

CFR2<11:8> CLK2 Divider ($\div N$) Control Bits

These 4 bits set the CLK2 divider ($\div N$) ratio where N is a value = 1 to 16 and CFR2<11:8> = 0000 means that N = 1 and CFR2<11:8> = 1111 means that N = 16 or N = CFR2<11:8> + 1.

Table 9. CLK2 Input Divider Values ($\div N$)

CFR2<15:12> =	N =	CFR2<11:8> =	N =
0000	1	1000	9
0001	2	1001	10
0010	3	1010	11
0011	4	1011	12
0100	5	1100	13
0101	6	1101	14
0110	7	1110	15
0111	8	1111	16

CFR2<7:6> Open

Unused locations. Write a Logic 0.

CFR2<5> CP Polarity

This bit sets the polarity of the charge pump in response to a ground referenced or a supply referenced VCO.

CFR2<5> = 0 (default). The charge pump is configured to operate with a supply referenced VCO. If CLK2 lags REFIN, the charge pump attempts to drive the VCO control node voltage higher. If CLK2 leads REFIN, the charge pump attempts to drive the VCO control node voltage lower.

CFR2<5> = 1. The charge pump is configured to operate with a ground referenced VCO. If CLK2 lags REFIN, the charge pump attempts to drive the VCO control node voltage lower. If CLK2 leads REFIN, the charge pump attempts to drive the VCO control node voltage higher.

CFR2<4> Charge Pump Full Power-Down

This bit, when set, puts the charge pump into a full power-down mode.

CFR2<4> = 0 (default). The charge pump is powered on and operating normally.

CFR2<4> = 1. The charge pump is powered down completely.

CFR2<3> Charge Pump Quick Power-Down

Rather than power down the charge pump, which can take a long time to recover from, a quick power-down mode that powers down only the charge pump output buffer is included. While this does not reduce the power consumption significantly, it does shut off the output to the charge pump and allows it to come back on rapidly.

CFR2<3> = 0 (default). The charge pump is powered on and operating normally.

CFR2<3> = 1. The charge pump is on and running, but the output buffer is powered down.

CFR2<2:0> Charge Pump Current Scale

A base output current from the charge pump is determined by a resistor connected from the CP_RSET pin to ground (see the PLL Circuitry section). However, it is possible to multiply the charge pump output current by a value from 1:8 by programming these bits. The charge pump output current is scaled by CFR2<2:0> +1.

CFR2<2:0> = 000 (default)

Scale factor = 1 to CFR2<2:0> = 111 (8).

AD9540

OUTLINE DIMENSIONS

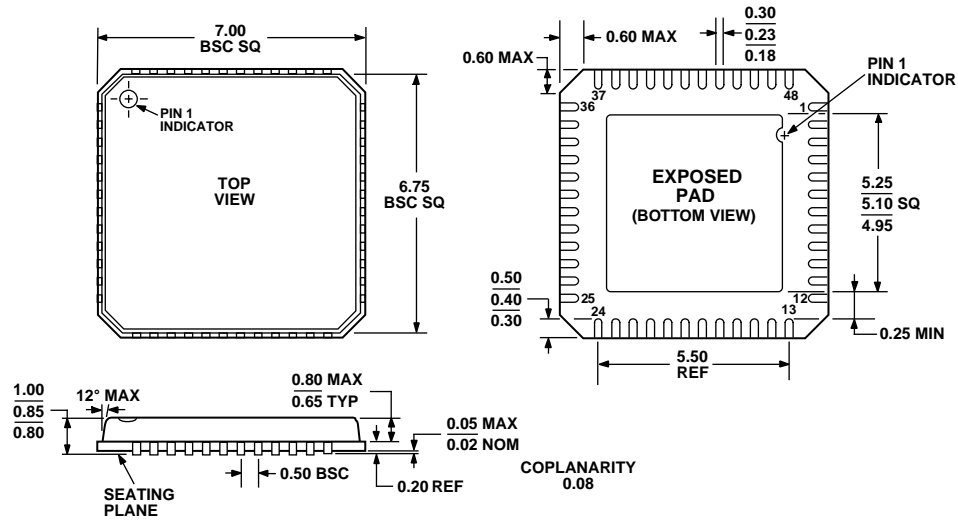

COMPLIANT TO JEDEC STANDARDS MO-220-VKKD-2

Figure 42. 48-Lead Lead Frame Chip Scale [LFCSP]
7 mm × 7 mm Body (CP-48)
Dimensions shown in millimeters

ORDERING GUIDE

Model	Temperature Range	Package Description	Package Option
AD9540BCPZ ¹	-40°C to +85°C	48-Lead Lead Frame Chip Scale Package (LFCSP)	CP-48
AD9540BCPZ-REEL ¹	-40°C to +85°C	48-Lead Lead Frame Chip Scale Package (LFCSP) Tape and Reel	CP-48
AD9540/PCB		Evaluation Board	

¹ Z = Pb-free part.



中发网 WWW.ZFA.CN

全球最大的PDF中文下载站



中发网
www.zfa.cn

PDF 资料下载尽在中发网