



AAT3112

500mA High Efficiency Charge Pump for White LED Flash Applications

ChargePump™

General Description

The AAT3112 is a member of AnalogicTech's Total Power Management IC™ (TPMIC™) family. It is a dual voltage doubling charge pump that provides a regulated output voltage. It operates with an input voltage range of 2.7 to 5.0 volts. The device can deliver a constant 200mA output load current and up to 500mA of pulsed current. The 500mA peak current capability of the AAT3112 makes it ideal for white LED flash applications. A low external parts count (two 1μF flying capacitors and two small capacitors at V_{IN} and V_{OUT}) makes the AAT3112 ideally suited for small battery-powered applications.

The AAT3112 has a thermal management system to protect the device in the event of a short-circuit condition at the output pin. Built-in soft-start circuitry prevents excessive inrush current during start-up. A high charge pump switching frequency enables the use of very small external capacitors. A low current shutdown feature disconnects the load from V_{IN} and reduces quiescent current to less than 1μA. The AAT3112 is available in a 16-pin 3x3mm QFN package and is rated over the -40°C to +85°C temperature range.

Features

- Input Voltage Range:
 - AAT3112-5.0: 2.7V to 5.0V
 - AAT3112-4.5: 2.7V to 4.5V
- Up to 500mA Peak Output Current
- 200mA Continuous Output Current
- I_Q < 1μA in Shutdown
- Regulated 4.5V or 5.0V Output
- 26μA of Quiescent Current
- Small Application Circuit
- Automatic Soft Start
- No Inductors
- Short-Circuit/Over-Temperature Protection
- 16-Pin 3x3mm QFN Package
- Temperature Range: -40°C to +85°C

Applications

- General-Purpose High-Current Boost Supply
- White LED Backlighting
- White LED Photo Flash

Typical Application

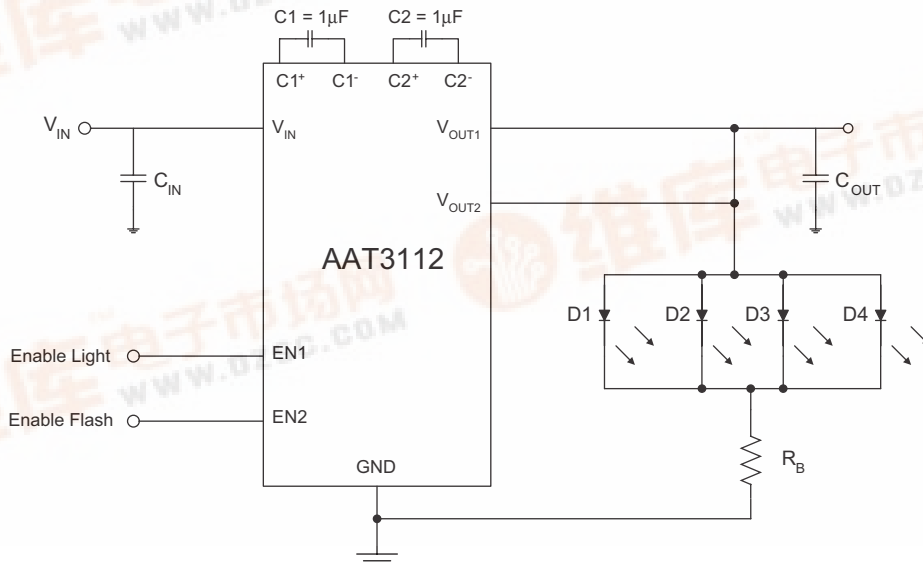

Pin Descriptions

| Pin # | Symbol | Function |
|-------|-------------------|--|
| 1 | N/C | No connect. |
| 2 | C2+ | Flying capacitor 2 positive terminal. Connect 1 μ F capacitor between C2+ and C2-. |
| 3 | C2- | Flying capacitor 2 negative terminal. |
| 4 | N/C | No connect. |
| 5 | V _{IN} | Input voltage. Connect to Pin 11. |
| 6 | GND | Ground connection. |
| 7 | EN2 | Enable pin. When connected high, Charge Pump 2 is enabled. When connected low, it disables the charge pump. |
| 8 | N/C | No connect. |
| 9 | EN1 | Enable pin. When connected high, Charge Pump 1 is enabled. When connected low, it disables the charge pump. |
| 10 | GND | Ground connection. |
| 11 | V _{IN} | Input voltage. Connect to Pin 5. |
| 12 | V _{OUT1} | Output pin for regulated output voltage. Bypass this pin to ground with a low ESR 10 μ F capacitor. |
| 13 | N/C | No connect. |
| 14 | C1+ | Flying capacitor 1 positive terminal. Connect 1 μ F capacitor between C1+ and C1-. |
| 15 | C1- | Flying capacitor 1 negative terminal. |
| 16 | V _{OUT2} | Regulated output voltage 2. Must be connected to V _{OUT1} for higher current applications. If used separately, bypass this pin to ground with a low ESR 10 μ F capacitor. |
| EP | | Exposed paddle (bottom); connect to GND directly beneath package. |

Pin Configuration

**QFN33-16
(Top View)**

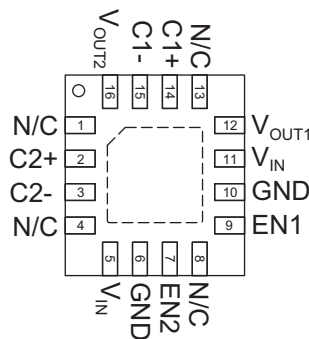

Absolute Maximum Ratings¹

| Symbol | Description | Value | Units |
|------------|--|------------|-------|
| V_{IN} | Input Voltage | -0.3 to 6 | V |
| V_{OUT} | Charge Pump Output | -0.3 to 6 | V |
| V_{EN} | EN to GND Voltage | -0.3 to 6 | V |
| T_J | Operating Junction Temperature Range | -40 to 150 | °C |
| T_{LEAD} | Maximum Soldering Temperature (at leads, 10 sec) | 300 | °C |

Note 1: Stresses above those listed in Absolute Maximum Ratings may cause permanent damage to the device. Functional operation at conditions other than the operating conditions specified is not implied. Only one Absolute Maximum Rating should be applied at any one time.

Thermal Information

| Symbol | Description | Value | Units |
|---------------|---|-------|-------|
| P_D | Maximum Power Dissipation | 2.0 | W |
| θ_{JA} | Maximum Thermal Resistance ¹ | 50 | °C/W |

Note 1: Mounted on an FR4 board.

Electrical Characteristics

$V_{IN} = 3.3V$, $V_{OUT} = 5.0V$, $C_{IN} = C_{OUT} = 10 \mu F$, $C1 = C2 = 1.0\mu F$; $T_A = -40^\circ C$ to $85^\circ C$, unless otherwise noted. Typical values are $T_A = 25^\circ C$.

| Symbol | Description | Conditions | Min | Typ | Max | Units |
|----------------------------|--------------------------------|---|------|-----|------|---------|
| AAT3112-4.5 | | | | | | |
| Input Power Supply | | | | | | |
| V_{IN} | Operation Range | | 2.7 | | 4.5 | V |
| I_Q | Quiescent Current ² | $2.7 \leq V_{IN} \leq 4.5$, $I_{OUT} = 0$ mA; $EN1 = EN2 = V_{IN}$ | | 26 | 60 | μA |
| I_{SHDN} | Shutdown Current | $EN1 = EN2 = 0$ | | | 1.0 | μA |
| I_{OUT} | Pulsed Output Current | $V_{IN} = 3.6V$; $V_{OUT} = 4.0V$; $T_{PULSE} = 50mS$ | | 590 | | mA |
| | | $V_{IN} = 3.6V$; $V_{OUT} = 4.0V$; $T_{PULSE} = 500mS$ | | 500 | | |
| V_{OUT} | Output Voltage | $2.7 \leq V_{IN} \leq 4.5$, $I_{OUT} = 100mA$ | 4.32 | 4.5 | 4.68 | V |
| | | $3.0 \leq V_{IN} \leq 4.5$, $I_{OUT} = 200mA$ | 4.32 | 4.5 | 4.68 | |
| Charge Pump Section | | | | | | |
| F_{CLK} | Clock Frequency | | | 750 | | KHz |
| η_{CP} | Charge Pump Efficiency | $V_{IN} = 2.7V$; $I_{OUT} = 100mA$ | | 80 | | % |
| EN | | | | | | |
| $V_{EN(L)}$ | Enable Threshold Low | | | | 0.3 | V |
| $V_{EN(H)}$ | Enable Threshold High | | 1.4 | | | V |
| I_{EN} | EN Input Leakage | | -1.0 | | 1.0 | μA |
| AAT3112-5.0 | | | | | | |
| Input Power Supply | | | | | | |
| V_{IN} | Operation Range | | 2.7 | | 5.0 | V |
| I_Q | Quiescent Current ² | $2.7 \leq V_{IN} \leq 5.0$, $I_{OUT} = 0$ mA; $EN1 = EN2 = V_{IN}$ | | 26 | 60 | μA |
| I_{SHDN} | Shutdown Current | $EN1 = EN2 = 0$ | | | 1.0 | μA |
| I_{OUT} | Pulsed Output Current | $V_{IN} = 3.6V$; $V_{OUT} = 4.5V$; $T_{PULSE} = 50mS$ | | 600 | | mA |
| | | $V_{IN} = 3.6V$; $V_{OUT} = 4.5V$; $T_{PULSE} = 500mS$ | | 500 | | |
| V_{OUT} | Output Voltage | $2.7 \leq V_{IN} \leq 5.0$, $I_{OUT} = 100mA$ | 4.8 | 5.0 | 5.2 | V |
| | | $3.0 \leq V_{IN} \leq 5.0$, $I_{OUT} = 200mA$ | 4.8 | 5.0 | 5.2 | |
| Charge Pump Section | | | | | | |
| F_{CLK} | Clock Frequency | | | 750 | | KHz |
| η_{CP} | Charge Pump Efficiency | $V_{IN} = 2.7V$; $I_{OUT} = 100mA$ | | 85 | | % |
| EN | | | | | | |
| $V_{EN(L)}$ | Enable Threshold Low | | | | 0.3 | V |
| $V_{EN(H)}$ | Enable Threshold High | | 1.4 | | | V |
| I_{EN} | EN Input Leakage | | -1.0 | | 1.0 | μA |

Notes:

- The AAT3112 is guaranteed to meet performance specifications over the $-40^\circ C$ to $+85^\circ C$ operating temperature range and is assured by design, characterization, and correlation with statistical process controls.
- V_{OUT1} and V_{OUT2} are pulled high to prevent switching.

Typical Characteristics

$V_{IN}=3.5V$, $C_{IN}=C_{OUT}=10\mu F$, $C1=C2=1\mu F$, $T_A=25^\circ C$, unless otherwise noted.

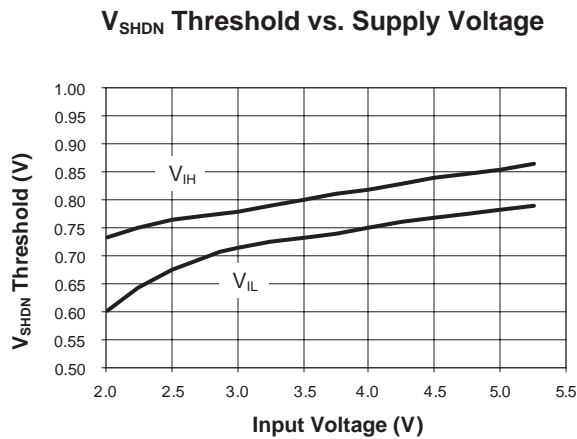
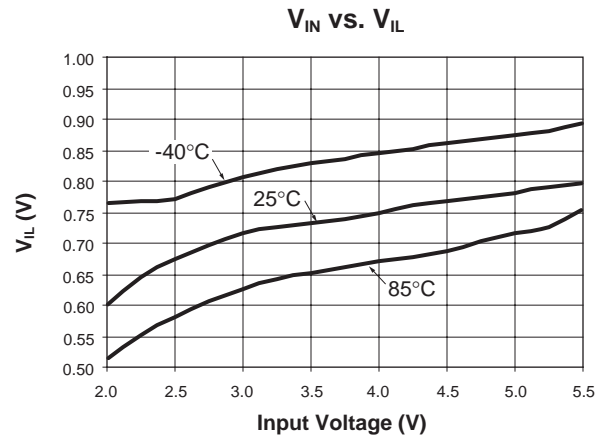
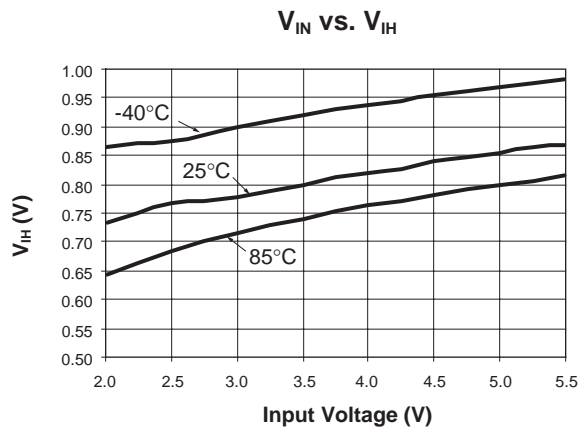

Typical Characteristics—AAT3112-4.5V

$V_{IN}=3.5V$, $C_{IN}=C_{OUT}=10\mu F$, $C1=C2=1\mu F$, $T_A=25^\circ C$, unless otherwise noted.

Output Voltage vs. Output Current

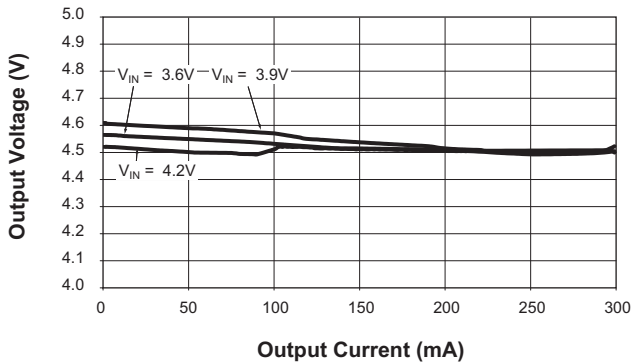

Supply Current vs. Supply Voltage
(No Load, No Switching)

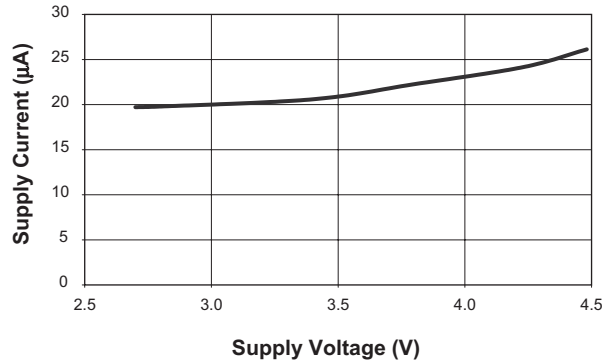

Startup Time with 100mA Load

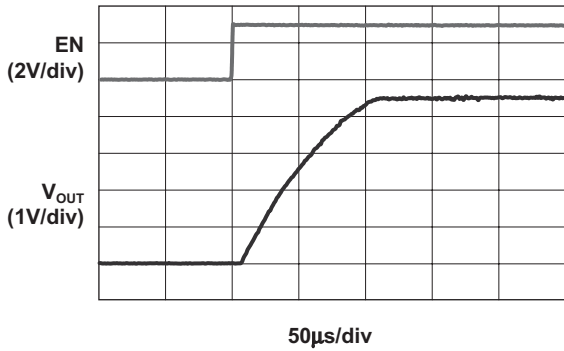

Startup Time with 200mA Load

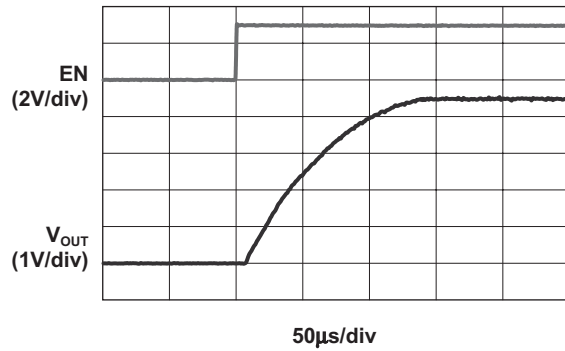

Maximum Current Pulse (50ms pulse)
vs. Input Voltage, $V_{OUT} > 4.0V$

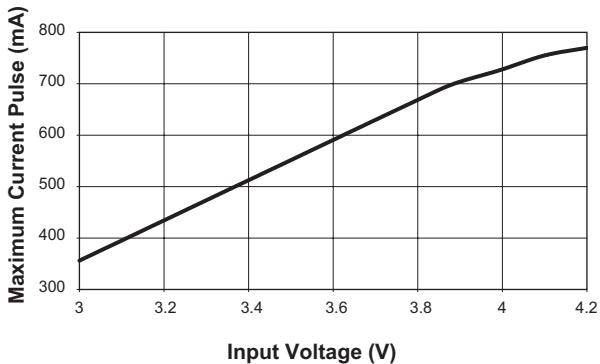

Efficiency vs. Supply Voltage

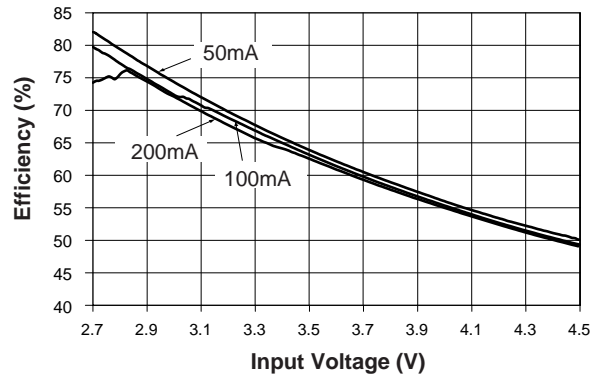

Typical Characteristics—AAT3112-4.5V

$V_{IN}=3.5V$, $C_{IN}=C_{OUT}=10\mu F$, $C1=C2=1\mu F$, $T_A=25^\circ C$, unless otherwise noted.

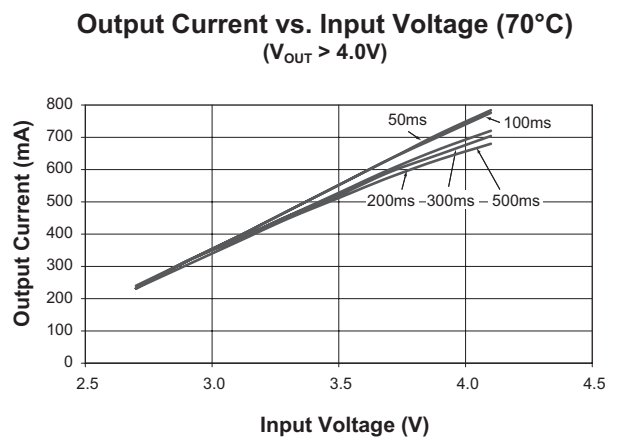
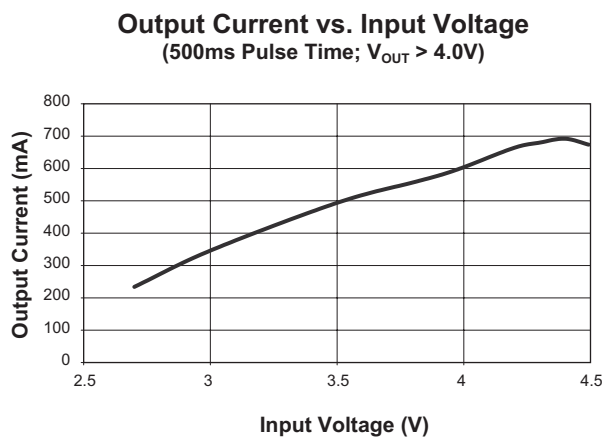
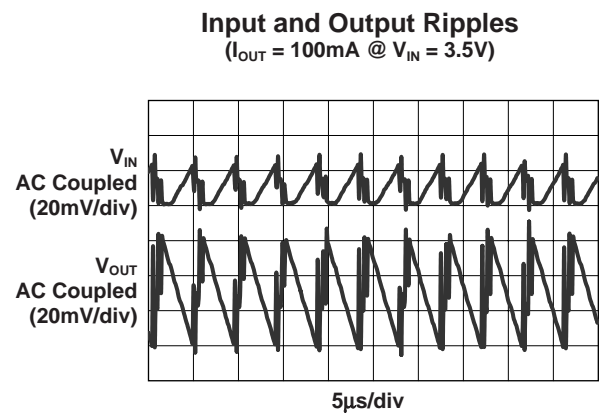
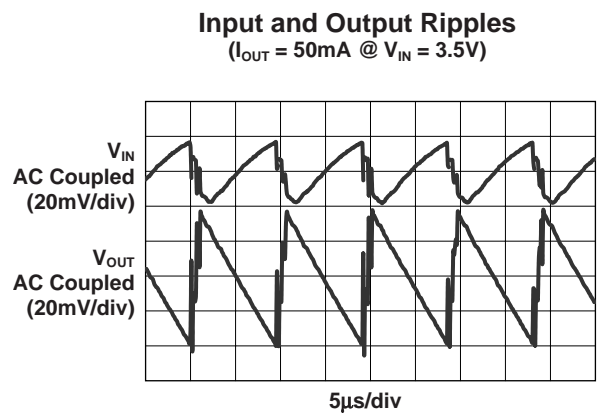
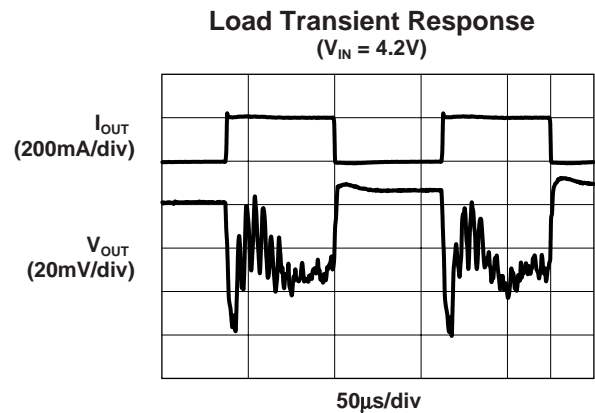
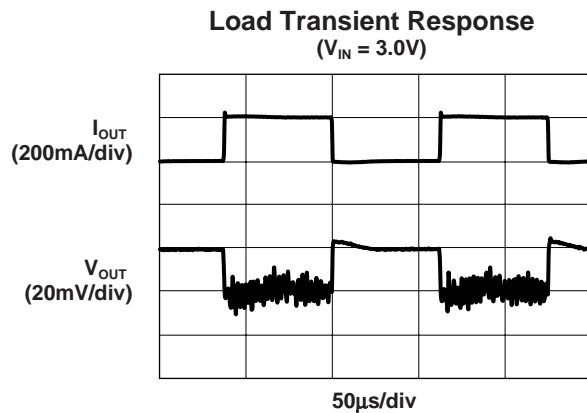

Typical Characteristics–AAT3112-4.5V

$V_{IN}=3.5V$, $C_{IN}=C_{OUT}=10\mu F$, $C1=C2=1\mu F$, $T_A=25^\circ C$, unless otherwise noted.

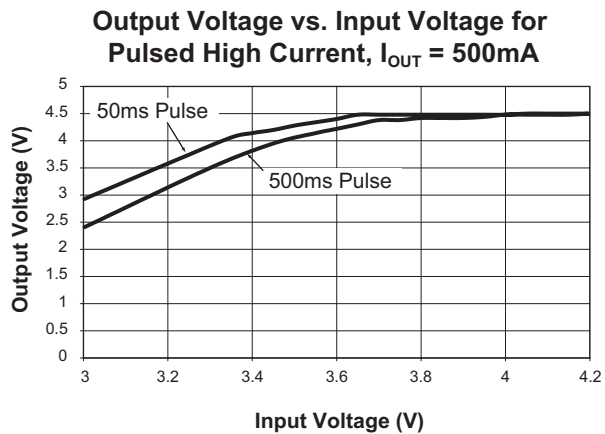

Typical Characteristics–AAT3112-5.0V

$V_{IN}=3.5V$, $C_{IN}=C_{OUT}=10\mu F$, $C1=C2=1\mu F$, $T_A=25^\circ C$, unless otherwise noted.

Output Voltage vs. Output Current

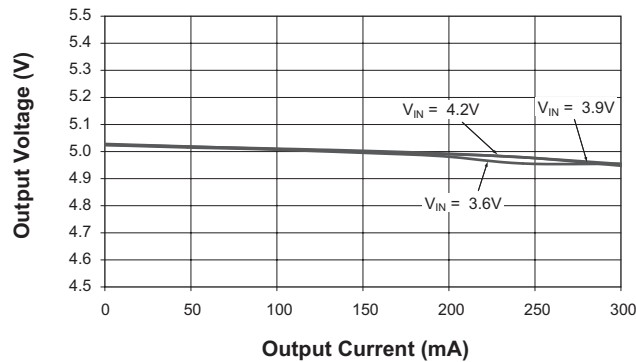

Supply Current vs. Supply Voltage (No Load, No Switching)

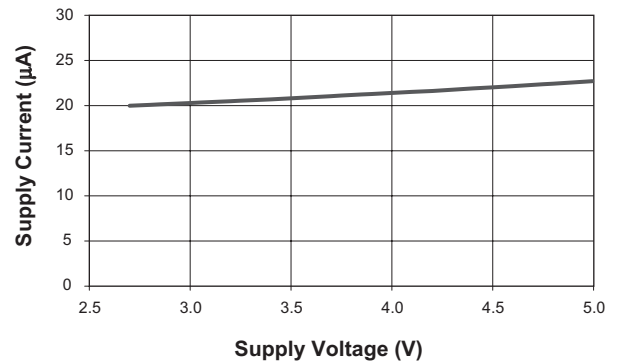

Startup Time with 100mA Load

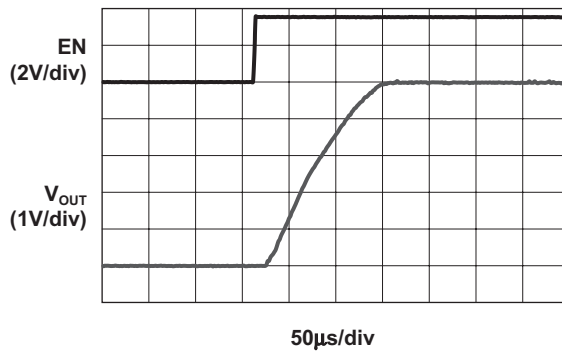

Startup Time with 200mA Load

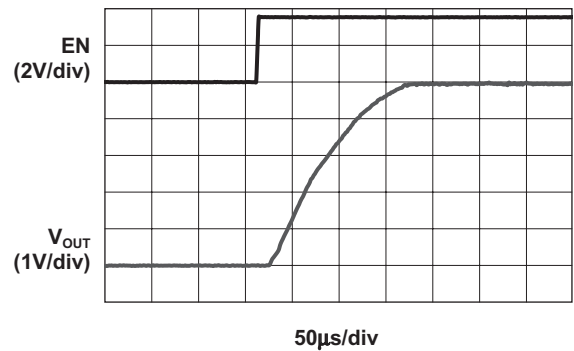

Maximum Current Pulse (50ms pulse) vs. Input Voltage, $V_{OUT} > 4.5V$

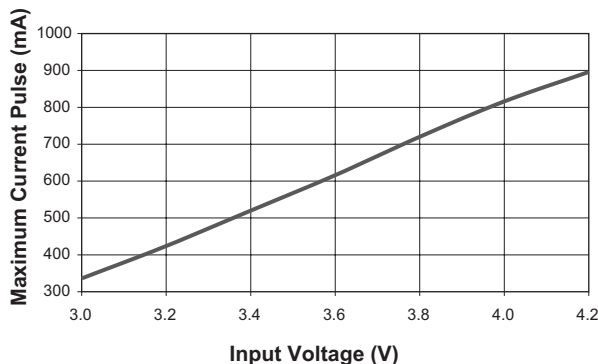

Efficiency vs. Supply Voltage

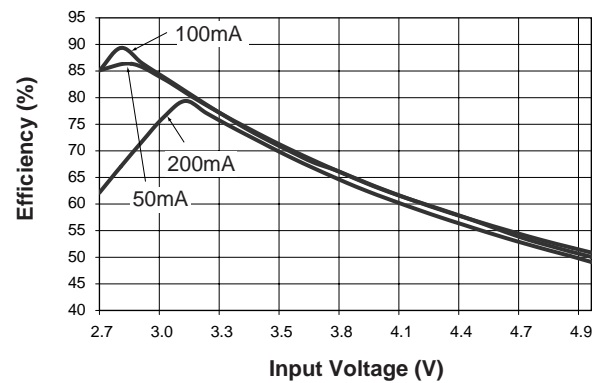

Typical Characteristics—AAT3112-5.0V

$V_{IN}=3.5V$, $C_{IN}=C_{OUT}=10\mu F$, $C1=C2=1\mu F$, $T_A=25^\circ C$, unless otherwise noted.

Load Transient Response
($V_{IN} = 3.0V$)

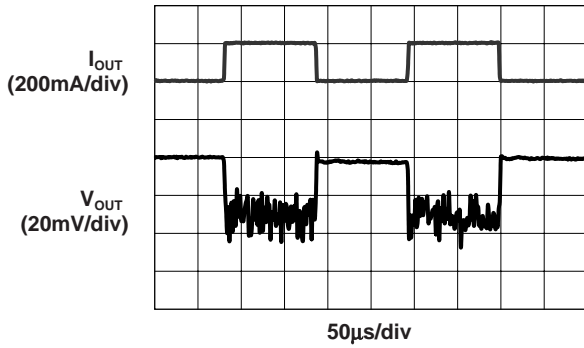

Load Transient Response
($V_{IN} = 4.2V$)

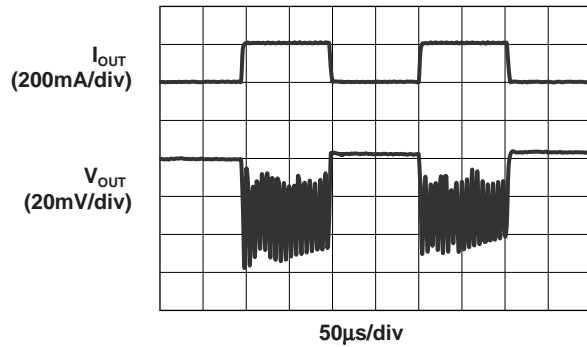

Input and Output Ripples
($I_{OUT} = 50mA$ @ $V_{IN} = 3.5V$)



Input and Output Ripples
($I_{OUT} = 100mA$ @ $V_{IN} = 3.5V$)

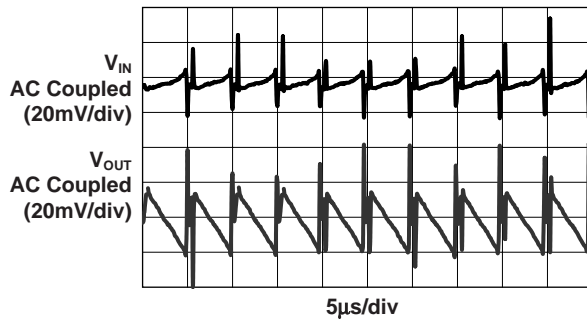

Output Current vs. Input Voltage
(500ms Pulse Time; $V_{OUT} > 4.5V$)

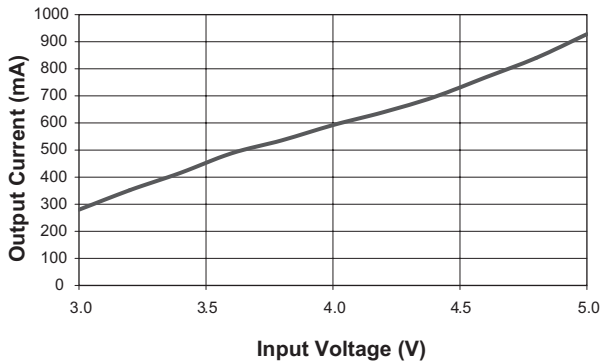

Output Current vs. Input Voltage (70°C)
($V_{OUT} > 4.5V$)

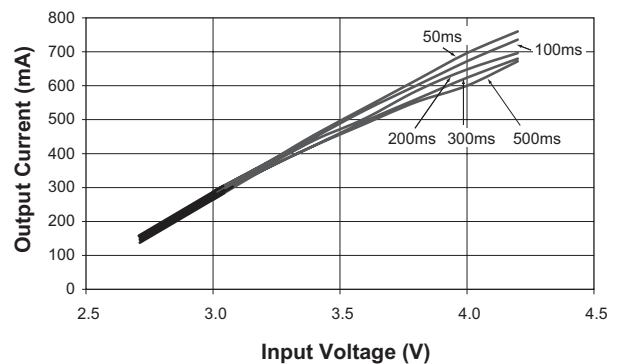

Typical Characteristics–AAT3112-5.0V

$V_{IN}=3.5V$, $C_{IN}=C_{OUT}=10\mu F$, $C1=C2=1\mu F$, $T_A=25^\circ C$, unless otherwise noted.

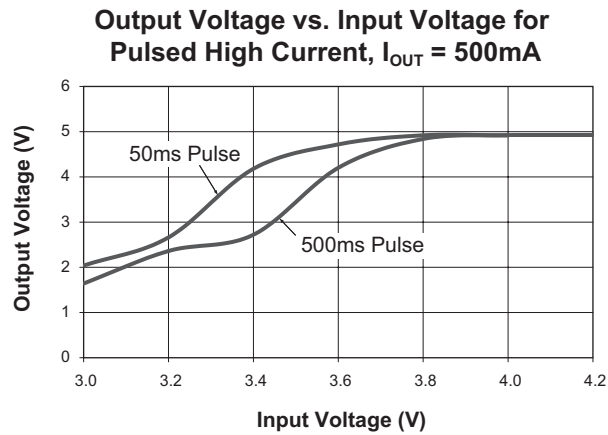

Functional Block Diagram

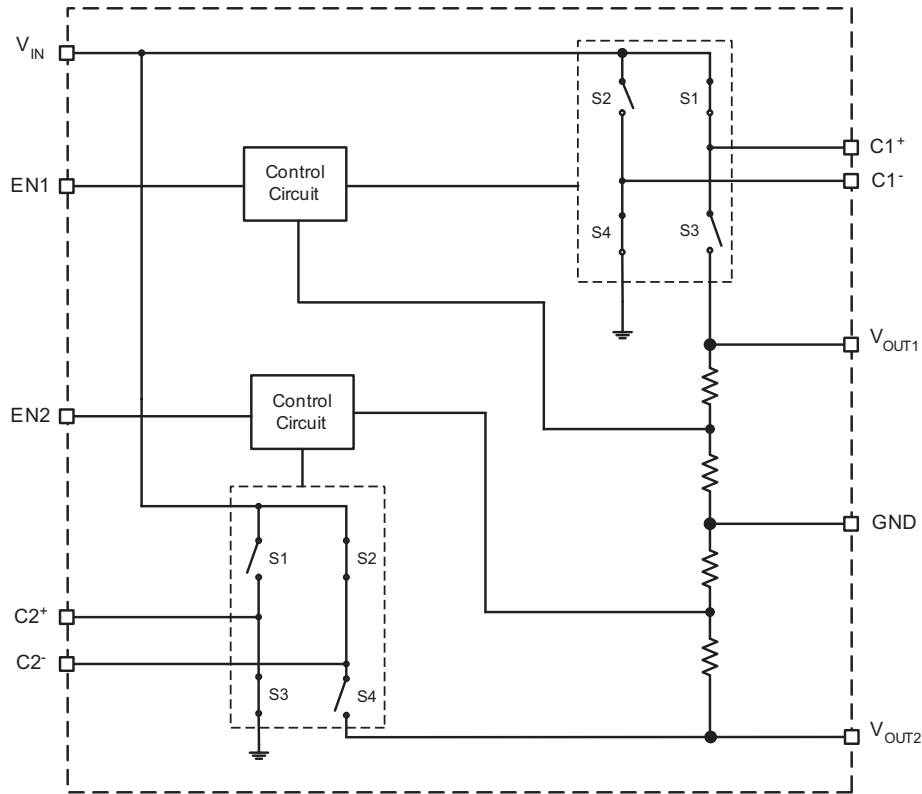

Functional Description

The AAT3112 is a dual charge pump intended for high-current applications. This device boosts an input voltage to a regulated output voltage. Regulation is achieved by sensing the output voltage through an internal resistor divider network. The AAT3112 requires only four external components: two 1.0 μ F ceramic capacitors for the charge pump (C1 and C2), one 10 μ F ceramic capacitor for C_{IN} , and one 10 μ F ceramic capacitor for C_{OUT} .

The AAT3112 is designed to deliver 200mA of continuous current and up to 500mA of pulsed current. Each charge pump engine has an independent enable pin to extend battery life. The charge pump switching frequency is approximately 750kHz, enabling the use of small external flying capacitors.

The AAT3112 has complete output short-circuit and thermal protection to safeguard the device under extreme operating conditions. An internal thermal protection circuit senses die temperature and will shut down the device if the internal junction temperature exceeds approximately 145°C.

Applications Information

Charge Pump Efficiency

The AAT3112 is a regulated output voltage doubling charge pump. The efficiency (η) can simply be defined as a linear voltage regulator with an effective output voltage that is equal to two times the input voltage. Efficiency (η) for an ideal voltage doubler can typically be expressed as the output power divided by the input power:

$$\eta = \frac{P_{OUT}}{P_{IN}}$$

In addition, with an ideal voltage doubling charge pump, the output current may be expressed as half the input current. The expression to define the ideal efficiency (η) can be rewritten as:

$$\eta = \frac{P_{OUT}}{P_{IN}} = \frac{V_{OUT} \times I_{OUT}}{V_{IN} \times 2I_{OUT}} = \frac{V_{OUT}}{2V_{IN}}$$

-or-

$$\eta(\%) = 100 \left(\frac{V_{OUT}}{2V_{IN}} \right)$$

For a charge pump with an output of 4.5 volts and a nominal input of 2.8 volts, the theoretical efficiency is 80.4%. Due to internal switching losses and IC quiescent current consumption, the actual efficiency can be measured at 79.6%. These figures are in close agreement across a wide range of output load conditions. Efficiency will decrease as load current drops below 0.05mA or when the level of V_{IN} approaches V_{OUT} .

Capacitor Selection

Careful selection of the four external capacitors C_{IN} , C1, C2, and C_{OUT} is important because they will affect turn-on time, output ripple, and transient performance. Optimum performance will be obtained when low equivalent series resistance (ESR) ceramic capacitors are used. In general, low ESR may be defined as less than 100m Ω .

Capacitor Characteristics

Ceramic composition capacitors are highly recommended over all other types of capacitors for use with the AAT3112. Ceramic capacitors offer many advantages over their tantalum and aluminum electrolytic counterparts. A ceramic capacitor typically has very low ESR, is lowest cost, has a smaller PCB footprint, and is non-polarized. Low ESR ceramic capacitors help to maximize charge pump transient response. Since ceramic capacitors are non-polarized, they are not prone to incorrect connection damage.

Equivalent Series Resistance: ESR is an important characteristic to consider when selecting a capacitor. ESR is a resistance internal to a capacitor that is caused by the leads, internal connections, size or area, material composition, and ambient temperature. Capacitor ESR is typically measured in milliohms for ceramic capacitors and can range to more than several ohms for tantalum or aluminum electrolytic capacitors.

Ceramic Capacitor Materials: Ceramic capacitors less than 0.1 μ F are typically made from NPO or COG materials. NPO and COG materials typically have tight tolerance and are stable over temperature. Large capacitor values are typically composed of X7R, X5R, Z5U, or Y5V dielectric materials. Large ceramic capacitors, typically greater than 2.2 μ F, are often available in low-cost Y5V and Z5U dielectrics, but large capacitors are not required in AAT3112 applications.

Capacitor area is another contributor to ESR. Capacitors that are physically large will have a lower ESR when compared to an equivalent material smaller capacitor. These larger devices can improve circuit transient response when compared to an equal value capacitor in a smaller package size.

Layout Considerations

High charge pump switching frequencies and large peak transient currents mandate careful printed circuit board layout. As a general rule for charge pump boost converters, all external capacitors should be located as closely as possible to the device package with minimum length trace connections.

Maximize the ground plane around the AAT3112 charge pump and make sure all external capacitors are connected to the immediate ground plane. A local component side ground plane is recommended.

Application Circuits

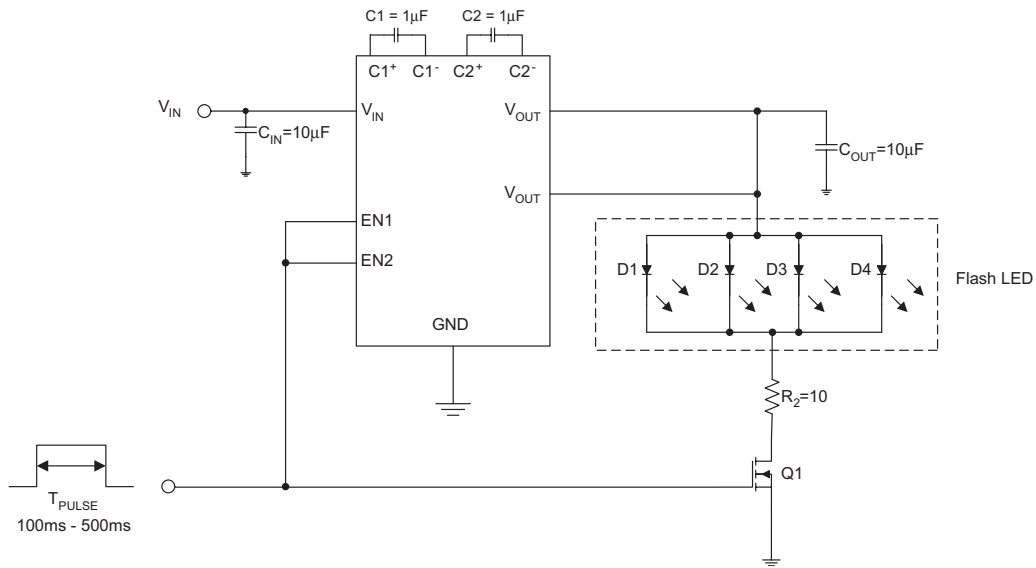

Figure 1: Flash Application.

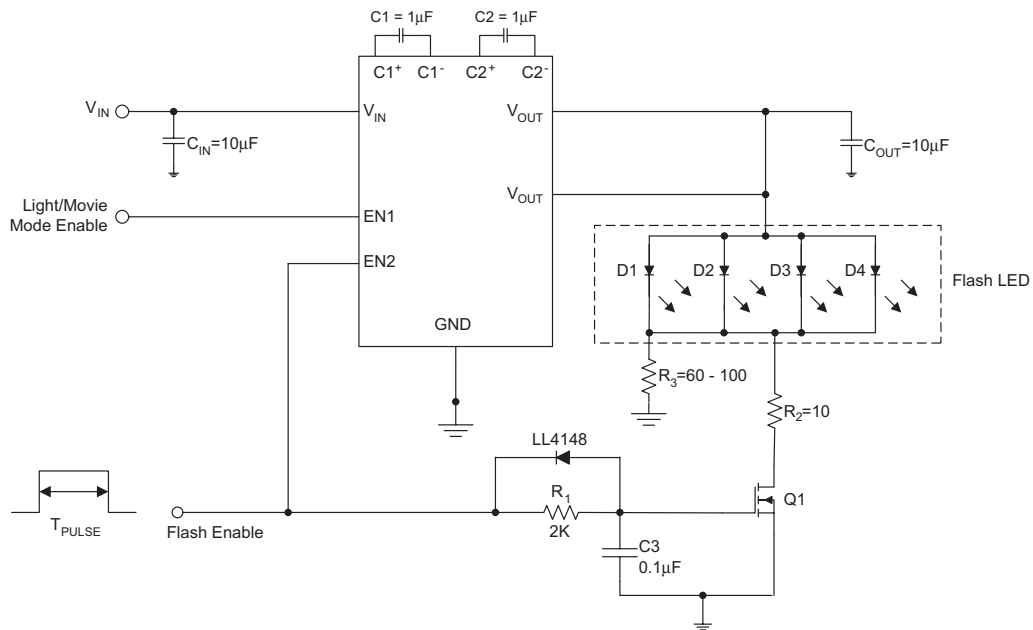

Figure 2: Movie Mode Light with Flash Function.

Ordering Information

| Package | Marking ¹ | Part Number (Tape and Reel) |
|----------|----------------------|-----------------------------|
| QFN33-16 | LGXYY | AAT3112IVN-4.5-T1 |
| QFN33-16 | MNXYY | AAT3112IVN-5.0-T1 |

Note 1: XYY = assembly and date code.
Sample stock is held on part numbers listed in **bold**.

Package Information

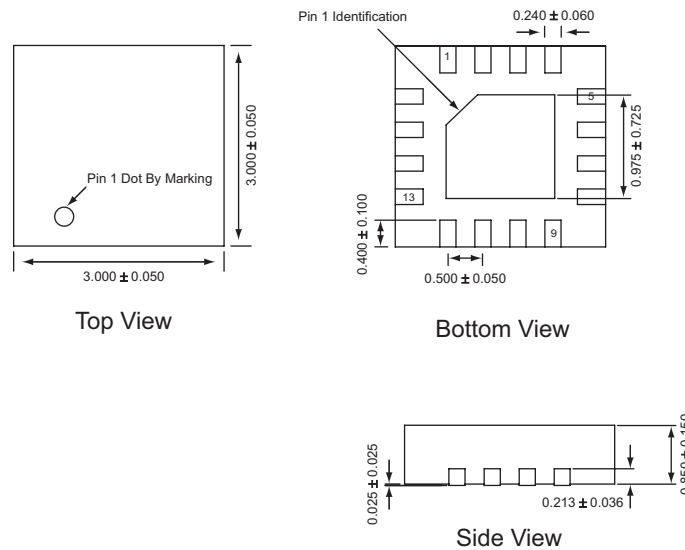

All dimensions in millimeters.



AAT3112

500mA High Efficiency Charge Pump for White LED Flash Applications

AnalogicTech cannot assume responsibility for use of any circuitry other than circuitry entirely embodied in an AnalogicTech product. No circuit patent licenses, copyrights, mask work rights, or other intellectual property rights are implied.

AnalogicTech reserves the right to make changes to their products or specifications or to discontinue any product or service without notice, and advise customers to obtain the latest version of relevant information to verify, before placing orders, that information being relied on is current and complete. All products are sold subject to the terms and conditions of sale supplied at the time of order acknowledgement, including those pertaining to warranty, patent infringement, and limitation of liability.

AnalogicTech warrants performance of its semiconductor products to the specifications applicable at the time of sale in accordance with AnalogicTech's standard warranty. Testing and other quality control techniques are utilized to the extent AnalogicTech deems necessary to support this warranty. Specific testing of all parameters of each device is not necessarily performed.

Advanced Analogic Technologies, Inc.
830 E. Arques Avenue, Sunnyvale, CA 94085
Phone (408) 737-4600
Fax (408) 737-4611

