



ADA10000

Linear Amplifier MMIC

Data Sheet - Rev 2.3

FEATURES

- High Linearity: +15 dBm IIP3 (+8 V supply)
- Low Distortion
- Low Noise Figure: 2.0 dB
- 15 dB Gain
- Single +4 V to +9 V Supply
- Wide Bandwidth: 50 MHz to 1 GHz
- SOIC-16 and SOT-89 Package Options



PRODUCT DESCRIPTION

The ADA10000 is a monolithic IC intended for use in applications requiring high linearity, such as Cellular Telephone Base Station Driver Amplifiers, CATV Fiber Receiver and Distribution Amplifiers, and CATV Drop

Amplifiers. Offered in both a modified 16 lead SOIC package and SOT-89 package, it is well suited for use in amplifiers where small size, reduced component count, and high reliability are important.

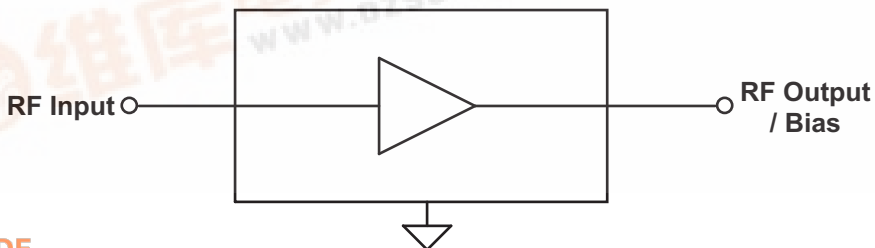

Figure 1: Block Diagram

ADA10000

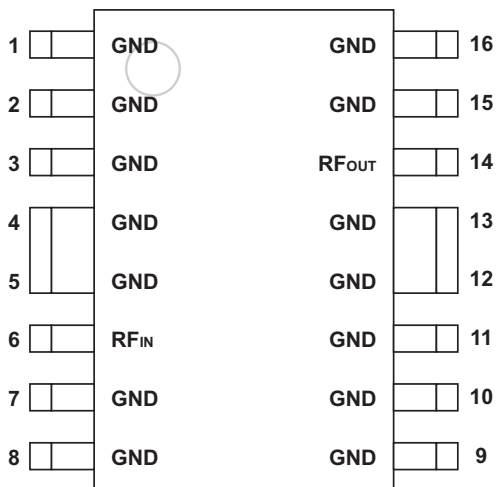

Figure 2: Pinout - S3 Package

Table 1: Pin Description - S3 Package

PIN	NAME	DESCRIPTION	PIN	NAME	DESCRIPTION
1	GND	Ground	16	GND	Ground
2	GND	Ground	15	GND	Ground
3	GND	Ground	14	RF _{OUT}	RF Output / Bias
4	GND	Ground	13	GND	Ground
5	GND	Ground	12	GND	Ground
6	RF _{IN}	RF Input	11	GND	Ground
7	GND	Ground	10	GND	Ground
8	GND	Ground	9	GND	Ground

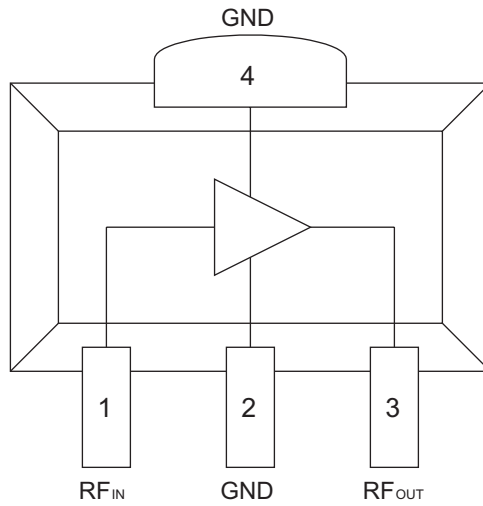

Figure 3: Pinout - S24 Package

Table 2: Pin Description - S24 Package

PIN	NAME	DESCRIPTION
1	RF _{IN}	RF Input
2	GND	Ground
3	RF _{OUT}	RF Output / Bias
4	GND	Ground

ADA10000

ELECTRICAL CHARACTERISTICS

Table 3: Absolute Minimum and Maximum Ratings

PARAMETER	MIN	MAX	UNIT
Supply (S3 package: pin 14) (S24 package: pin 3)	0	+12	VDC
RF Power at Input (S3 package: pin 6) (S24 package: pin 1)	-	+10	dBm
Storage Temperature	-65	+150	°C

Stresses in excess of the absolute ratings may cause permanent damage. Functional operation is not implied under these conditions. Exposure to absolute ratings for extended periods of time may adversely affect reliability.

Notes:

(1) RF input pin must be AC-coupled. No DC external bias should be applied.

Table 4: Operating Ranges

PARAMETER	MIN	TYP	MAX	UNIT
RF Input / Output Frequency	50	-	1000	MHz
Supply Voltage (V_{DD})	+4	+8	+9	VDC
Case Temperature	-40	-	+85 ⁽¹⁾	°C

The device may be operated safely over these conditions; however, parametric performance is guaranteed only over the conditions defined in the electrical specifications.

Notes:

(1) Median time to failure will degrade above this temperature.

Table 5: Electrical Specifications
 (T_A = +25 °C, V_{DD} = +8 VDC, 75 Ω system, see Figures 4 and 5)

PARAMETER	MIN	TYP	MAX	UNIT	COMMENT
CSO ⁽¹⁾ / CSO ⁽²⁾	60 / 62	-	-	dBc	
CTB ⁽¹⁾ /CTB ⁽²⁾	65 / 74	-	-	dBc	
Gain	14	15	-	dB	
Noise Figure	-	2.0	3.5	dB	
2nd Order Input Intercept Point (IIP2) ⁽³⁾	+29	+34	-	dBm	
3rd Order Input Intercept Point (IIP3) ⁽³⁾	+13	+15	-	dBm	
Thermal Resistance	-	-	35 20	°C/W	S3 package S24 package
Current Consumption ⁽⁴⁾	50	-	150	mA	

Notes:

(1) 160 channels, +17 dBmV per channel (measured at output), 6 MHz channel spacing.

(2) 80 channels, +19 dBmV per channel (measured at output), 6 MHz channel spacing.

(3) Two tones, -10 dBm per tone at input.

(4) The device can be operated at V_{DD} = +6 VDC for lower power dissipation. Refer to Figures 7, 8, 13, and 16 for performance variation with supply voltage.

ADA10000

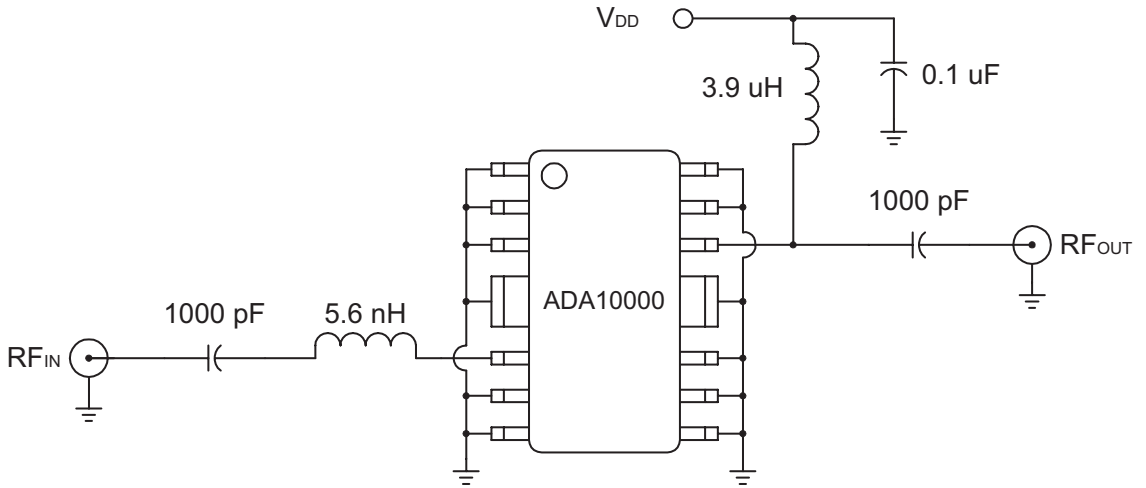

Figure 4: Test Circuit - S3 Packaged Device (75 Ω terminations)

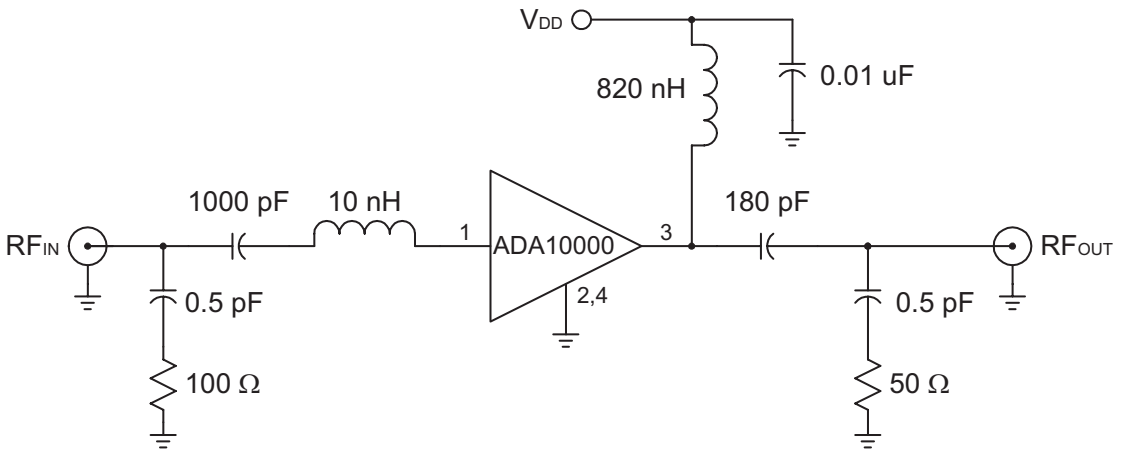

Figure 5: Test Circuit - S24 Packaged Device (75 Ω terminations)

PERFORMANCE DATA As measured in test circuits shown in Figures 4 and 5.

Figure 6: Gain and Noise Figure vs. Frequency - S3 Packaged Device
($T_A = +25\text{ }^\circ\text{C}$, $V_{DD} = +8\text{ V}$, $75\ \Omega$ system)

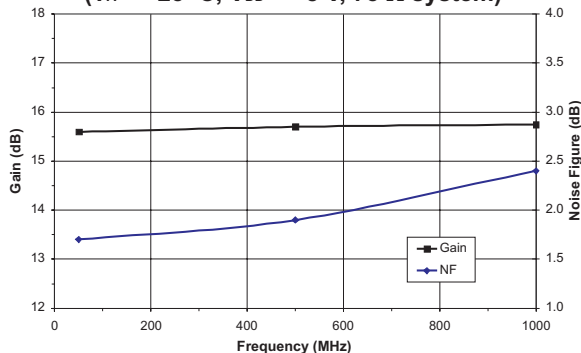

Figure 7: Gain and Noise Figure vs. Supply Voltage - S3 Packaged Device
($T_A = +25\text{ }^\circ\text{C}$, $f = 500\text{ MHz}$, $75\ \Omega$ system)

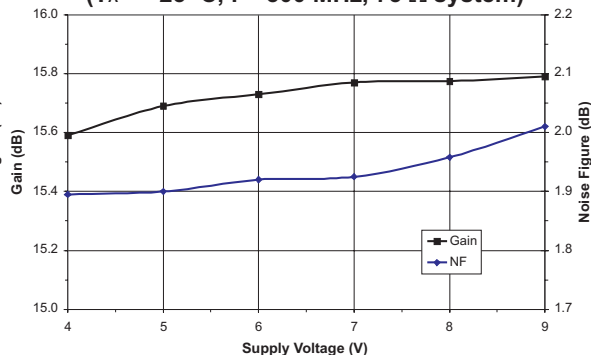

Figure 8: IIP2 and IIP3 vs. Supply Voltage - S3 Packaged Device
($T_A = +25\text{ }^\circ\text{C}$, $75\ \Omega$ system)

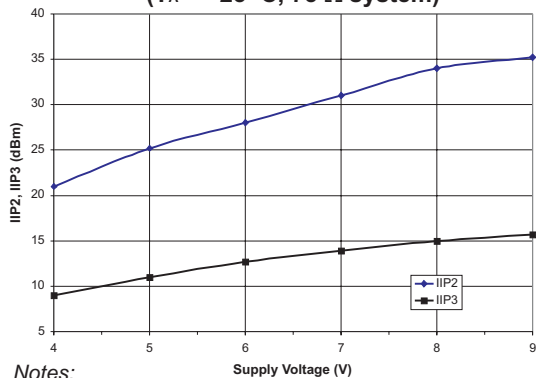
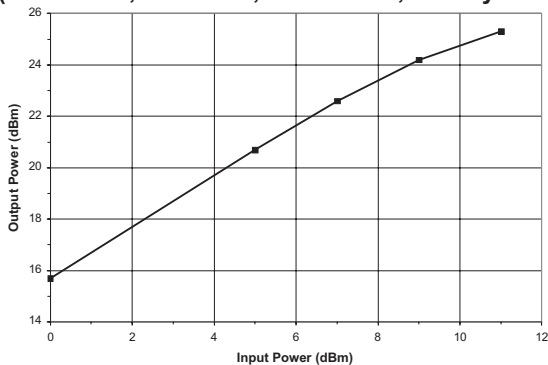

Figure 9: Output Power vs. Input Power S3 Packaged Device
($T_A = +25\text{ }^\circ\text{C}$, $V_{DD} = +8\text{ V}$, $f = 500\text{ MHz}$, $75\ \Omega$ system)



Notes:

1. IIP2 measured at 986.5 MHz; Input = two tones at 55.25 MHz and 931.25 MHz at -10 dBm.
2. IIP3 measured with two tones at the input: 986.5 MHz and 992.5 MHz at -10 dBm.

Figure 10: Unmatched Device Input Impedance S3 Packaged Device
($T_A = +25\text{ }^\circ\text{C}$, $V_{DD} = +8\text{ V}$, $75\ \Omega$ system)

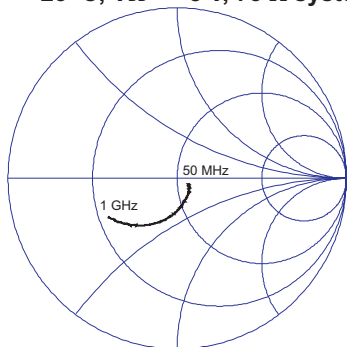
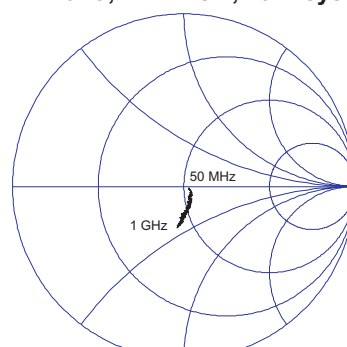

Figure 11: Unmatched Device Output Impedance S3 Packaged Device
($T_A = +25\text{ }^\circ\text{C}$, $V_{DD} = +8\text{ V}$, $75\ \Omega$ system)



Refer to the ANADIGICS web site for full 2-port s-parameter data.

ADA10000

Figure 12: Gain and Noise Figure vs. Frequency - S24 Packaged Device
 ($T_A = +25\text{ }^\circ\text{C}$, $V_{DD} = +8\text{ V}$, $75\ \Omega$ system)

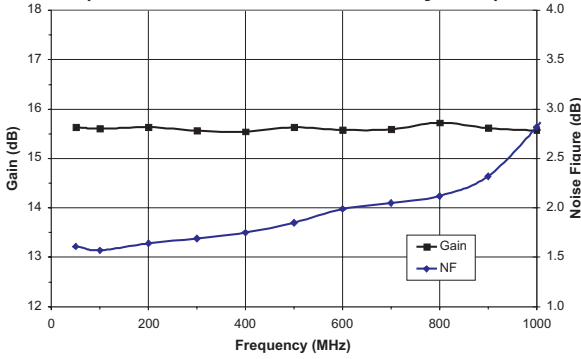

Figure 13: Gain and Noise Figure vs. Supply Voltage - S24 Packaged Device
 ($T_A = +25\text{ }^\circ\text{C}$, $f = 500\text{ MHz}$, $75\ \Omega$ system)

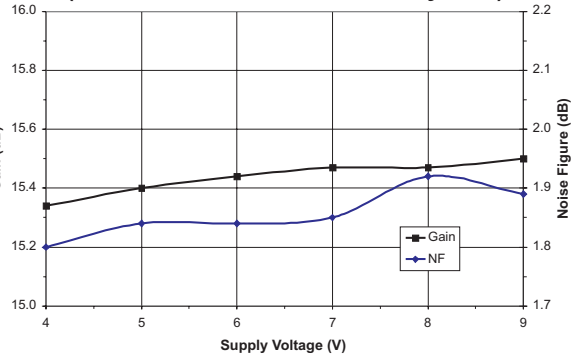

Figure 14: Input Return Loss vs. Frequency - S24 Packaged Device
 ($T_A = +25\text{ }^\circ\text{C}$, $V_{DD} = +8\text{ V}$, $75\ \Omega$ system)

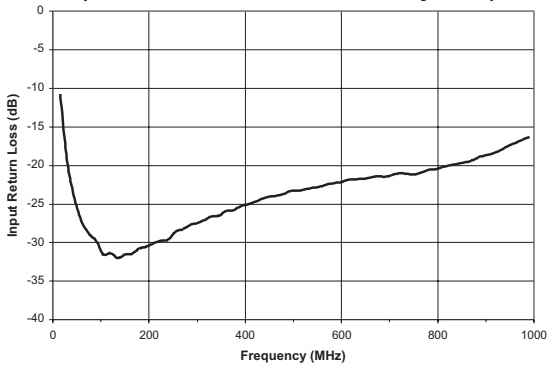

Figure 15: Output Return Loss vs. Frequency - S24 Packaged Device
 ($T_A = +25\text{ }^\circ\text{C}$, $V_{DD} = +8\text{ V}$, $75\ \Omega$ system)

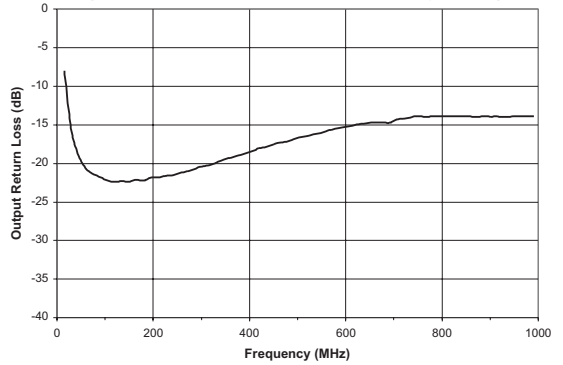

Figure 16: IIP2 and IIP3 vs. Supply Voltage - S24 Packaged Device
 ($T_A = +25\text{ }^\circ\text{C}$, $75\ \Omega$ system)

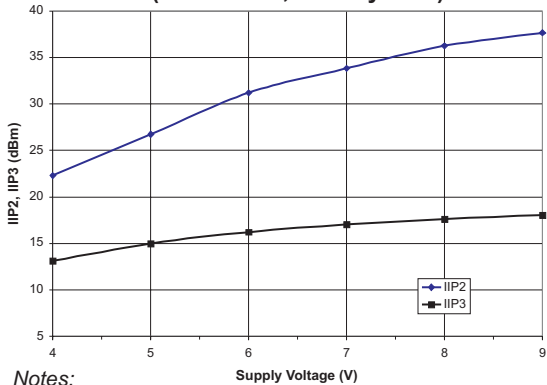
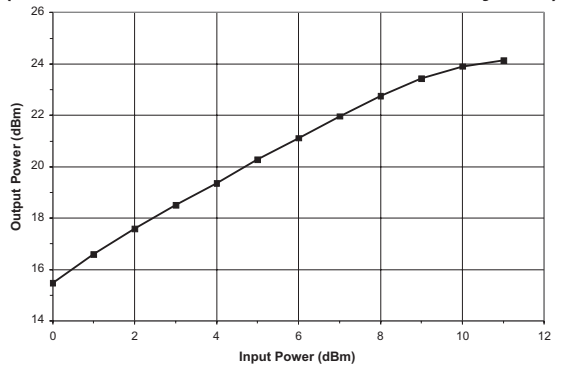

Figure 17: Output Power vs. Input Power S24 Packaged Device
 ($T_A = +25\text{ }^\circ\text{C}$, $V_{DD} = +8\text{ V}$, $f = 500\text{ MHz}$, $75\ \Omega$ system)



Notes:

1. IIP2 measured at 986.5 MHz; Input = two tones at 55.25 MHz and 931.25 MHz at -10 dBm.
2. IIP3 measured with two tones at the input: 986.5 MHz and 992.5 MHz at -10 dBm

**Figure 18: Unmatched Device Input Impedance
S24 Packaged Device
($T_A = +25\text{ }^\circ\text{C}$, $V_{DD} = +8\text{ V}$, $75\ \Omega$ system)**

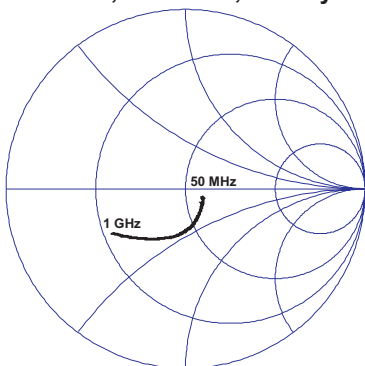

**Figure 19: Unmatched Device Output Impedance
S24 Packaged Device
($T_A = +25\text{ }^\circ\text{C}$, $V_{DD} = +8\text{ V}$, $75\ \Omega$ system)**

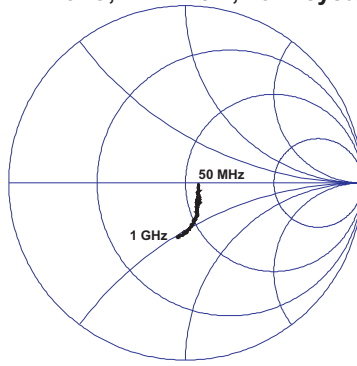

Refer to the ANADIGICS web site for full 2-port s-parameter data.

ADA10000

PACKAGE OUTLINE

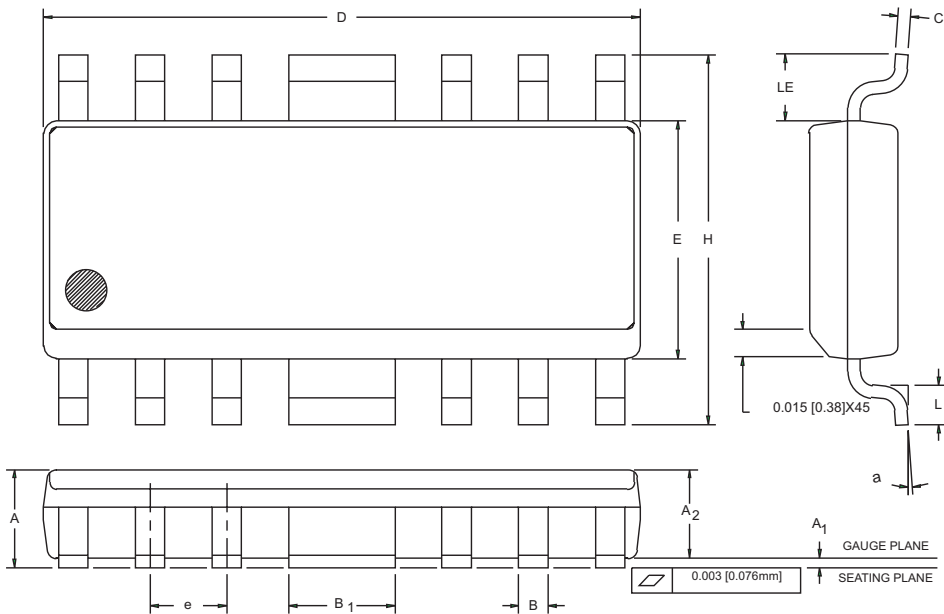

SYMBOL	INCHES		MILLIMETERS		NOTE
	MIN.	MAX.	MIN.	MAX.	
A	0.058	0.068	1.47	1.73	
A ₁	0.004	0.010	0.10	0.25	
A ₂	0.055	0.065	1.40	1.65	
B	0.013	0.020	0.33	0.50	
B ₁	0.062	0.070	1.58	1.78	
C	0.008	0.010	0.20	0.25	4
D	0.380	0.400	9.66	10.16	2
E	0.150	0.160	3.81	4.06	3
e	0.050 BSC		1.27 BSC		
H	0.226	0.244	5.74	6.20	
L	0.016	0.040	0.41	1.02	
LE	0.030	—	0.76	—	
a	0	8	0	8	

NOTES:

1. CONTROLLING DIMENSION: INCHES
2. DIMENSION "D" DOES NOT INCLUDE MOLD FLASH, PROTRUSIONS OR GATE BURRS. MOLD FLASH, PROTRUSIONS AND GATE BURRS SHALL NOT EXCEED 0.006 [0.15mm] PER SIDE.
3. DIMENSION "E" DOES NOT INCLUDE INTER-LEAD FLASH OR PROTRUSIONS. INTER-LEAD FLASH AND PROTRUSIONS SHALL NOT EXCEED 0.010 [0.25mm] PER SIDE.
4. LEAD THICKNESS AFTER PLATING TO BE 0.013 [0.33mm] MAXIMUM.

Figure 20: S3 Package Outline - Modified 16 Pin SOIC

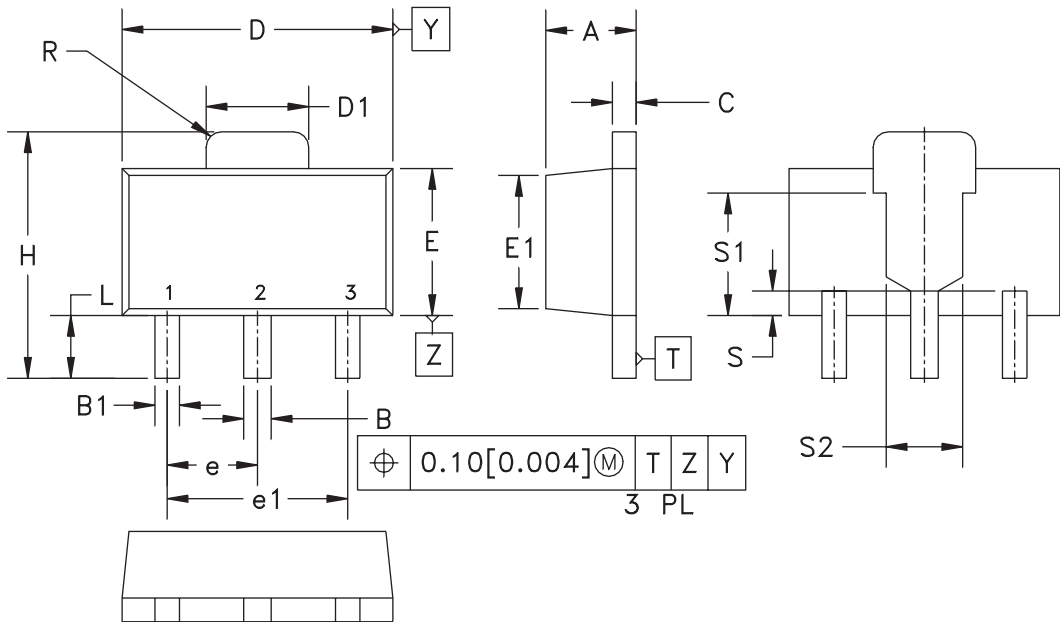

SYMBOL	MILLIMETERS		INCHES		NOTE
	MIN.	MAX.	MIN.	MAX.	
A	1.40	1.60	0.055	0.063	-
B	0.44	0.56	0.017	0.022	-
B1	0.36	0.48	0.014	0.019	3
C	0.35	0.44	0.014	0.017	-
D	4.40	4.60	0.173	0.181	-
D1	1.62	1.83	0.064	0.072	-
E	2.29	2.60	0.090	0.102	-
E1	2.13	2.29	0.084	0.090	4
e	1.50	BSC	0.059	BSC	-
e1	3.00	BSC	0.118	BSC	-
H	3.94	4.25	0.155	0.167	-
L	0.89	1.20	0.035	0.047	-
R	-	0.25	-	0.010	-
S	0.40	NOM.	0.016	NOM.	4
S1	2.03	NOM.	0.080	NOM.	4
S2	1.27	NOM.	0.050	NOM.	4

NOTES:

1. CONTROLLING DIMENSIONS: MILLIMETERS.
2. DIMENSIONS DO NOT INCLUDE END FLASH, MOLD FLASH OR MATERIAL PROTRUSIONS.
3. DIMENSION B1, 2 PLACES.
4. DIMENSIONS E1, S, S1 & S2 - REFERENCE ONLY.
5. REFERENCE JEDEC TO-243 (AA).

Figure 21: S24 Package Outline - SOT-89

ADA10000

ORDERING INFORMATION

ORDER NUMBER	TEMPERATURE RANGE	PACKAGE DESCRIPTION	COMPONENT PACKAGING
ADA10000S3CTR	-40 °C to +85 °C	Modified 16 Pin SOIC	3,500 piece Tape and Reel
ADA10000S3C	-40 °C to +85 °C	Modified 16 Pin SOIC	Plastic tubes (50 pieces per tube)
ADA10000S24Q1	-40 °C to +85 °C	SOT-89 Package	1,000 piece Tape and Reel



ANADIGICS, Inc.

141 Mount Bethel Road

Warren, New Jersey 07059, U.S.A.

Tel: +1 (908) 668-5000

Fax: +1 (908) 668-5132

URL: <http://www.anadigics.com>

E-mail: Mktg@anadigics.com

IMPORTANT NOTICE

ANADIGICS, Inc. reserves the right to make changes to its products or to discontinue any product at any time without notice. The product specifications contained in Advanced Product Information sheets and Preliminary Data Sheets are subject to change prior to a product's formal introduction. Information in Data Sheets have been carefully checked and are assumed to be reliable; however, ANADIGICS assumes no responsibilities for inaccuracies. ANADIGICS strongly urges customers to verify that the information they are using is current before placing orders.

WARNING

ANADIGICS products are not intended for use in life support appliances, devices or systems. Use of an ANADIGICS product in any such application without written consent is prohibited.