



Thermal Monitor and Fan Speed (RPM) Controller

ADM1034

FEATURES

- 1 local and 2 remote temperature channels
- ±1°C accuracy on local and remote channels
- Automatic remote temperature channels, up to 1 kΩ
- Fast (up to 64 measurements per second)
- SMBus 2.0, 1.1, and 1.0 compliant
- SMBus address input/LOCATION input to UDID
- Programmable over-/undertemperature limits
- Programmable fault queue
- SMBus ALERT output
- Fail-safe overtemperature comparator output
- Fan speed (RPM) controller

- Look-up table for temperature-to-fan-speed control
- Linear and discrete options for look-up table
- FAN_FAULT output
- THERM input, used to time PROCHOT assertions
- REF input, used as reference for THERM (PROCHOT)
- 3 V to 5.5 V supply
- Small 16-lead QSOP package

APPLICATIONS

- Desktop and notebook PCs
- Embedded systems
- Telecommunications equipment
- LCD projectors

FUNCTIONAL BLOCK DIAGRAM

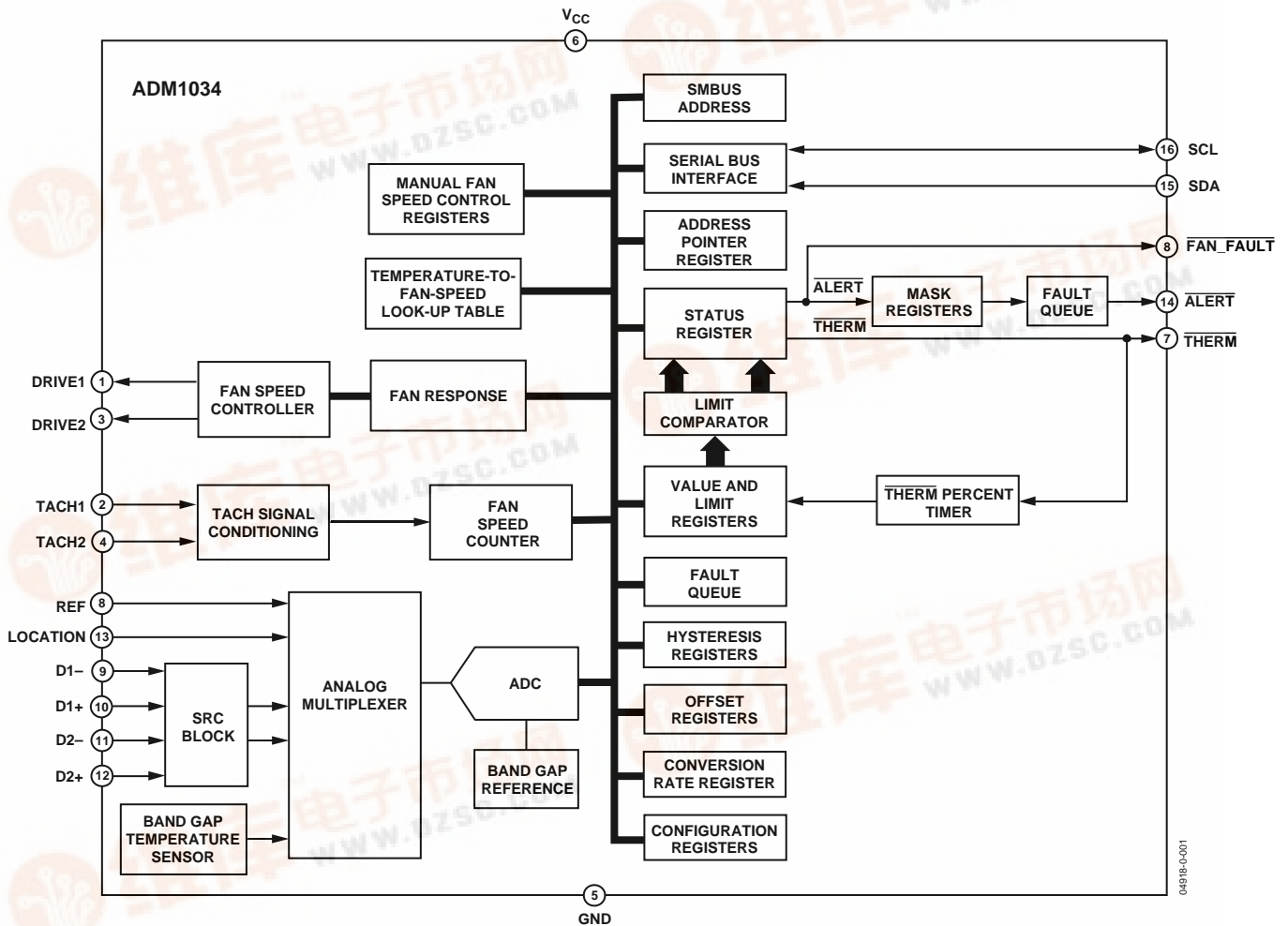

Figure 1.



Rev. 0
Information furnished by Analog Devices is believed to be accurate and reliable. However, no responsibility is assumed by Analog Devices for its use, nor for any infringements of patents or other rights of third parties that may result from its use. Specifications subject to change without notice. No license is granted by implication or otherwise under any patent or patent rights of Analog Devices. Trademarks and registered trademarks are the property of their respective owners.

TABLE OF CONTENTS

Specifications.....	4	$\overline{\text{ALERT}}$ Interrupt Behavior	21
Absolute Maximum Ratings.....	6	Handling $\overline{\text{SMBUSALERT}}$ Interrupts	22
Thermal Characteristics	6	Interrupt Masking Register	22
ESD Caution.....	6	$\overline{\text{FAN_FAULT}}$ Output	23
Pin Configuration and Function Descriptions.....	7	Fault Queue	23
Typical Performance Characteristics	8	Conversion Rate Register	23
Functional Description	10	$\overline{\text{THERM}}$ I/O Timer and Limits	23
Internal Registers.....	10	$\overline{\text{THERM}}$ % Limit Register	24
Serial Bus Interface.....	10	Fan Drive Signal	25
Location Input.....	10	Synchronous Speed Control	25
SMBus 2.0 ARP-Capable Mode	10	Fan Inputs.....	26
SMBus 2.0 Fixed-and-Discoverable Mode.....	12	Fan Speed Measurement	26
SMBus 2.0 Read and Write Operations	12	Fan Speed Measurement Registers.....	27
Register Addresses for Single/Block Byte Modes	14	Reading Fan Speed	27
Write Operations	14	Calculating Fan Speed	27
Read Operations	15	Alarm Speed.....	27
SMBus Timeout	15	Look-Up Table: Modes of Operation.....	28
Packet Error Checking (PEC)	15	Setting Up the Size of the Look-Up Table.....	29
Alert Response Address (ARA)	15	Setting Up the Look-Up Table in Linear Mode.....	29
Temperature Measurement System.....	16	Setting Which Temperature Channel Controls a Fan	29
Internal Temperature Measurement	16	Look-Up Table Hysteresis	29
Remote Temperature Measurement.....	16	Programming the $\overline{\text{THERM}}$ Limit for Each Temperature Channel.....	30
Additional Functions	18	XOR Tree Test Mode.....	30
Layout Considerations	19	Lock Bit	30
Limits, Status Registers, and Interrupts	20	SW Reset.....	30
8-Bit Limits	20	Outline Dimensions	40
Out-of-Limit Comparisons	20	Ordering Guide	40
Analog Monitoring Cycle Time.....	20		
Status Registers	20		

REVISION HISTORY

8/04—Revision 0: Initial Version

GENERAL DESCRIPTION

The ADM1034 is a dual-channel remote- and local-temperature sensor and fan controller. The remote channels monitor the temperature of two remote thermal diodes, which may be discrete 2N3904/6s or may be located on a microprocessor die. The device also monitors its own ambient temperature.

The ADM1034 can monitor and control the speed of two cooling fans. The user can program a target fan speed, or else use the look-up table to input a temperature-to-fan-speed profile. The look-up table can be configured to run the fans at

discrete speeds (discrete mode) or to ramp the fan speed with temperature (linear mode).

The ADM1034 communicates over a 2-wire SMBus 2.0 interface. An 8-level LOCATION input allows the user to choose between SMBus 1.1 and SMBus 2.0. An ALERT output indicates error conditions. The THERM I/O signals over-temperature as an output and times THERM assertions as an input. Pin 8 can be configured as a reference for the THERM (PROCHOT) input.

ADM1034

SPECIFICATIONS

$T_A = T_{MIN}$ to T_{MAX} , $V_{CC} = V_{MIN}$ to V_{MAX} , unless otherwise noted.¹

Table 1.

Parameter	Min	Typ	Max	Unit	Test Conditions/Comments
POWER SUPPLY					
Supply Voltage, V_{CC}^2	3.0	3.30	3.6	V	Interface inactive, ADC active Standby mode
Supply Current, I_{CC}			3	mA	
			900	μ A	
Undervoltage Lockout Threshold		2.5		V	
Power-On Reset Threshold	1		2.4	V	
TEMPERATURE-TO-DIGITAL CONVERTER					
Internal Sensor Accuracy		± 1	± 2	$^{\circ}$ C	$20^{\circ}\text{C} \leq T_A \leq 60^{\circ}\text{C}$
	-4		+2	$^{\circ}$ C	$-40^{\circ}\text{C} \leq T_A \leq +100^{\circ}\text{C}$
Resolution		0.03125		$^{\circ}$ C	
External Diode Sensor Accuracy		± 0.5	± 1	$^{\circ}$ C	$-40^{\circ}\text{C} \leq T_D \leq +100^{\circ}\text{C}; T_A = +40^{\circ}\text{C}$
		± 1		$^{\circ}$ C	$-40^{\circ}\text{C} \leq T_D \leq +100^{\circ}\text{C}; +20^{\circ}\text{C} \leq T_A \leq +60^{\circ}\text{C}$
	-3		+2	$^{\circ}$ C	$-40^{\circ}\text{C} \leq T_D \leq +100^{\circ}\text{C}; -40^{\circ}\text{C} \leq T_A \leq +100^{\circ}\text{C}$
Resolution		0.03125		$^{\circ}$ C	
Remote Sensor Source Current		85		μ A	High level
		34		μ A	Mid level
		5		μ A	Low level
Series Resistance Cancellation			1000	Ω	
Power Supply Sensitivity		± 1		%/V	
Conversion Time (Local Temperature)		11		ms	Averaging enabled
Conversion Time (Remote Temperature)		32		ms	Averaging enabled
Total Conversion Time		75		ms	Averaging enabled
OPEN-DRAIN DIGITAL OUTPUTS (ALERT, THERM, FAN_FAULT, DRIVE1, DRIVE2)³					
Output Low Voltage, V_{OL}			0.4	V	$I_{OUT} = -6.0\text{ mA}; V_{CC} = +3\text{ V}$
High Level Output Leakage Current, I_{OH}		0.1	1	μ A	$V_{OUT} = V_{CC}; V_{CC} = 3\text{ V}$
DIGITAL INPUT LEAKAGE CURRENT (TACH1, TACH2)					
Input High Current, I_{IH}	-1			μ A	$-V_{IN} = V_{CC}$
Input Low Current, I_{IL}			1	μ A	$V_{IN} = 0$
Input Capacitance, C_{IN}		7		pF	
DIGITAL INPUT LOGIC LEVELS (TACH1, TACH2)					
Input High Voltage, V_{IH}	2.0		5.5	V	
Input Low Voltage, V_{IL}	-0.3		+0.8	V	
Hysteresis		500		mV p-p	
OPEN-DRAIN SERIAL DATA BUS OUTPUT (SDA)					
Output Low Voltage, V_{OL}			0.4	V	$I_{OUT} = -6.0\text{ mA}; V_{CC}$
High Level Output Leakage Current, I_{OH}		0.1	1	μ A	$V_{OUT} = V_{CC}$
SERIAL BUS DIGITAL INPUTS (SCL, SDA)					
Input High Voltage, V_{IH}	2.1			V	
Input Low Voltage, V_{IL}			0.8	V	
Hysteresis		500		mV	

Parameter	Min	Typ	Max	Unit	Test Conditions/Comments
ANALOG INPUTS					
(LOCATION, REF)					
Input Resistance	80	125	160	kΩ	
AGTL + INPUT (THERM)					
Input High Level		0.75 × REF		V	
Input Low Level			0.4	V	
TACHOMETER ACCURACY					
Fan Speed Measurement Accuracy			±4	%	
SERIAL BUS TIMING⁴					
Clock Frequency, f_{SCLK}			400	kHz	See Figure 2
Glitch Immunity, t_{SW}		50		ns	See Figure 2
Bus Free Time, t_{BUF}	1.3			μs	See Figure 2
Start Setup Time, $t_{SU:STA}$	0.6			μs	See Figure 2
Start Hold Time, $t_{HD:STA}$	0.6			μs	See Figure 2
Stop Condition Setup Time $t_{SU:STO}$	0.6			μs	See Figure 2
SCL Low Time, t_{LOW}	1.3			μs	See Figure 2
SCL High Time, t_{HIGH}	0.6			μs	See Figure 2
SCL, SDA Rise Time, t_r			1000	ns	See Figure 2
SCL, SDA Fall Time, t_f			300	ns	See Figure 2
Data Setup Time, $t_{SU:DAT}$	100			ns	See Figure 2
Detect Clock Low Timeout, $t_{TIMEOUT}$	25		35	ms	See Note 5

¹ Typicals are at $T_A = 25^\circ\text{C}$ and represent most likely parametric norm. Standby current typ is measured with $V_{CC} = 3.3\text{ V}$. Timing specifications are tested at logic levels of $V_{IL} = 0.8\text{ V}$ for a falling edge and $V_{IH} = 2.1\text{ V}$ for a rising edge.

² Operation at 5.5 V is guaranteed by design, not production tested.

³ Recommend use of 100 kΩ pull-up resistors for all open-drain outputs from the ADM1034.

⁴ Guaranteed by design, not production tested.

⁵ SMBus timeout disabled by default. See the SMBUS section for more information.

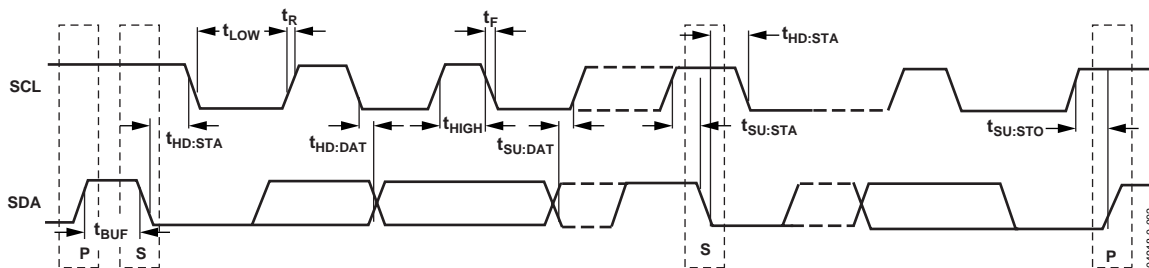

Figure 2. Serial Bus Timing Diagram

ADM1034

ABSOLUTE MAXIMUM RATINGS

Table 2.

Parameter	Rating
Positive Supply Voltage (V_{CC})	-0.3 V to +6.5 V
Voltage on Any Input or Output Pin except $\overline{\text{FAN_FAULT}}$ and LOCATION	-0.3 V to +6.5 V
Voltage on $\overline{\text{FAN_FAULT}}$ ¹	V_{CC}
Voltage on LOCATION	$V_{CC} + 0.3 \text{ V}$
Input Current at Any Pin	$\pm 20 \text{ mA}$
Maximum Junction Temperature ($T_J \text{ max}$)	150°C
Storage Temperature Range	-65°C to +150°C
Lead Temperature, Soldering (10 s)	300°C
IR Reflow Peak Temperature	220°C
ESD Rating—All Pins	1500 V

¹ During power-up the voltage on $\overline{\text{FAN_FAULT}}$ should not be higher than V_{CC} .

ESD CAUTION

ESD (electrostatic discharge) sensitive device. Electrostatic charges as high as 4000 V readily accumulate on the human body and test equipment and can discharge without detection. Although this product features proprietary ESD protection circuitry, permanent damage may occur on devices subjected to high energy electrostatic discharges. Therefore, proper ESD precautions are recommended to avoid performance degradation or loss of functionality.



Stresses above those listed under Absolute Maximum Ratings may cause permanent damage to the device. This is a stress rating only; functional operation of the device at these or any other conditions above those indicated in the operational section of this specification is not implied. Exposure to Absolute Maximum Rating conditions for extended periods may affect device reliability.

THERMAL CHARACTERISTICS

16-Lead QSOP Package:

$\theta_{JA} = 150^\circ\text{C/W}$, $\theta_{JC} = 39^\circ\text{C/W}$

PIN CONFIGURATION AND FUNCTION DESCRIPTIONS

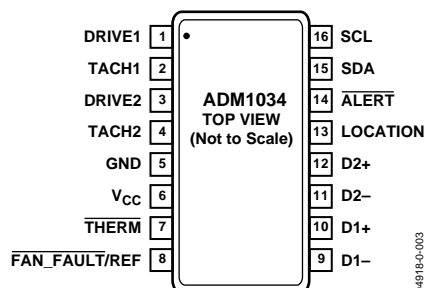

Figure 3. Pin Configuration

Table 3. Pin Function Descriptions

Pin No.	Mnemonic	Description
1	DRIVE1	DRIVE1 Pin Drives Fan 1. Open-drain output. Requires a pull-up resistor.
2	TACH1	Fan 1 Fan Speed Measurement Input. Connects to the fan's TACH output to measure the fan speed.
3	DRIVE2	DRIVE2 Pin Drives Fan 2. Open-drain output. Requires a pull-up resistor.
4	TACH2	Fan 2 Fan Speed Measurement Input. Connects to the fan's TACH output to measure the fan speed.
5	GND	Ground for Analog and Digital Circuitry.
6	V _{CC}	Power. Can be powered by 3.3 V standby power if monitoring in low power states is required.
7	THERM	Can be configured as an overtemperature interrupt output, or as an input (to monitor $\overline{\text{PROCHOT}}$ output of an INTEL CPU). A timer measures assertion times on the THERM pin (either input or output).
8	FAN_FAULT/REF	FAN_FAULT: Open-Drain Output. Asserted low when one or both fans stall. Requires a pull-up resistor to V _{CC} . REF: Analog Input Reference for the THERM Input.
9	D1-	Cathode Connection for the First Thermal Diode or Diode-Connected Transistor.
10	D1+	Anode Connection for the First Thermal Diode or Diode-Connected Transistor.
11	D2-	Cathode Connection for the Second Thermal Diode or Diode-Connected Transistor.
12	D2+	Anode Connection for the Second Thermal Diode or Diode-Connected Transistor.
13	LOCATION	8-Level Analog Input. Used to determine the correct SMBus version and the SMBus address (in fixed-and-discoverable mode) and to set the LLL bits in the UDID (in ARP-capable mode).
14	ALERT	Open-Drain Output. SMBusALERT pin. Alerts the system in the case of out-of-limit events, such as over temperature. Can be configured as sticky SMBus mode or comparator mode.
15	SDA	Serial Bus Bidirectional Data. Connects to the SMBus master's data line. Requires pull-up resistor if not provided elsewhere in the system.
16	SCL	Serial SMBus Clock Input. Connects to the SMBus master's clock line. Requires pull-up resistor if not already provided in the system.

TYPICAL PERFORMANCE CHARACTERISTICS

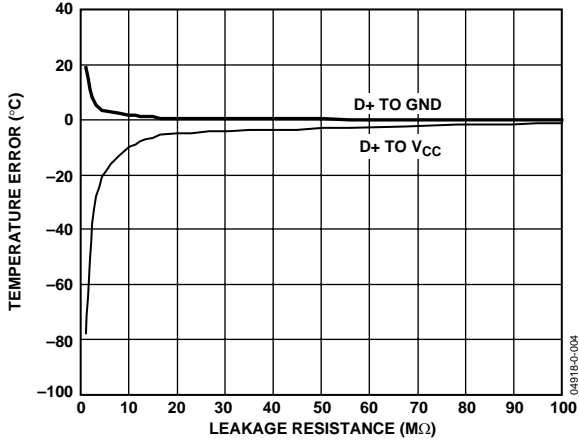

Figure 4. Temperature Error vs. PCB Track Resistance DXP to GND and V_{CC}

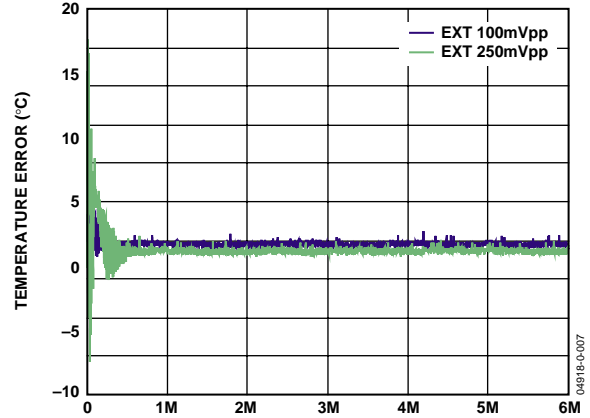

Figure 7. Remote Temperature Error vs. Power Supply Noise Frequency

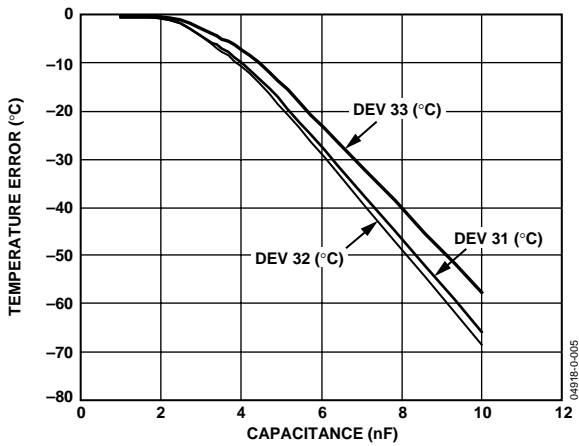

Figure 5. Remote Temperature Error vs. D+, D- Capacitance

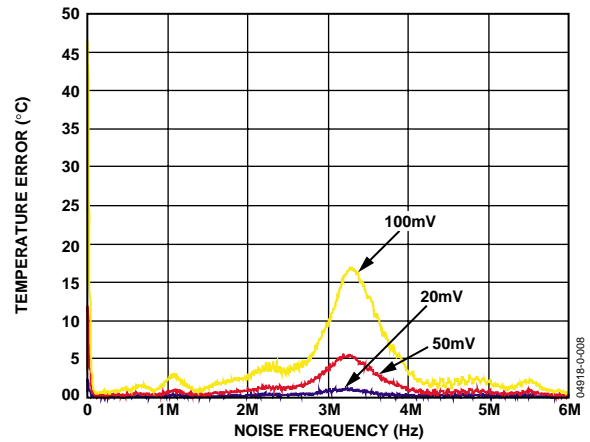

Figure 8. Remote Temperature Error vs. Common-Mode Noise Frequency Coupled on D+ and D-

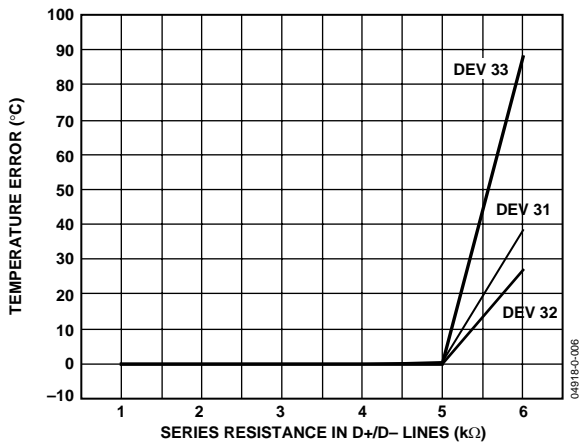

Figure 6. Remote Temperature Error vs. Series Resistance on D+ and D-

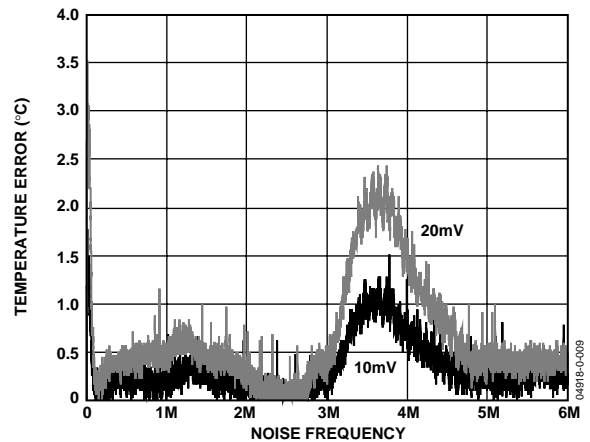

Figure 9. Remote Temperature Error vs. Differential Mode Noise Frequency Coupled on D+ and D-

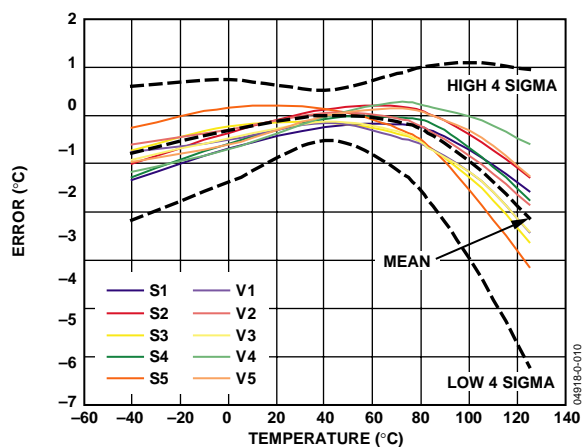

Figure 10. Remote Temperature Error vs. Actual Diode Temperature

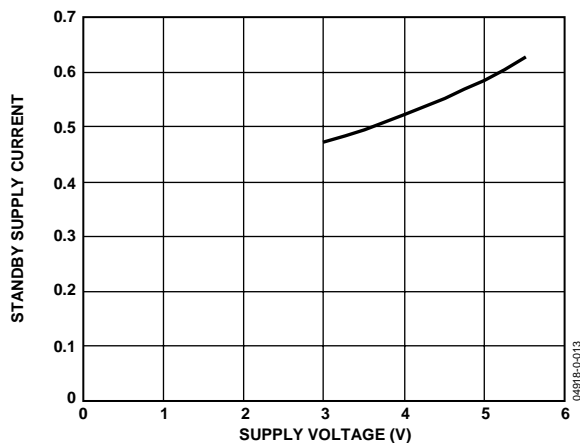

Figure 13. Standby Supply Current vs. Supply Voltage

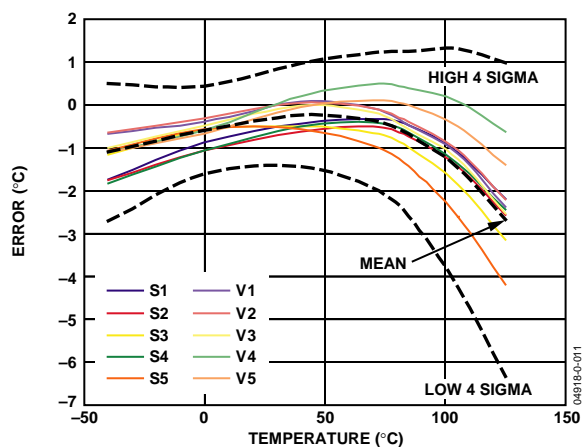

Figure 11. Local Temperature Error vs. Actual Temperature

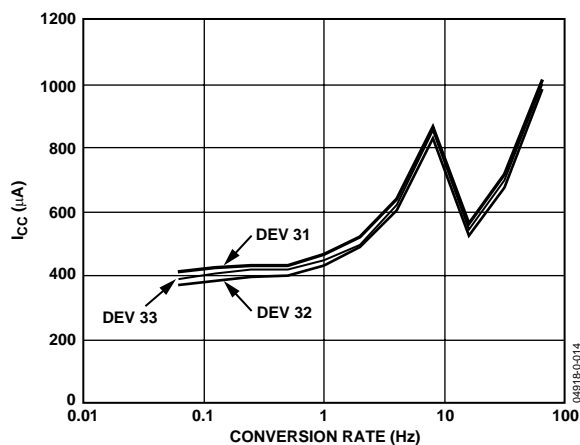

Figure 14. Supply Current vs. Conversion Rate

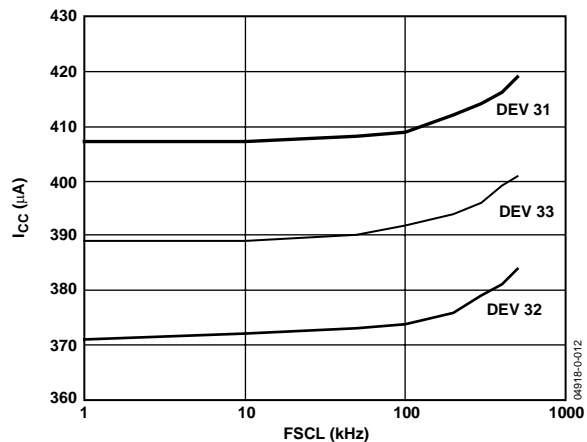

Figure 12. Standby Supply Current vs. SCLK Frequency

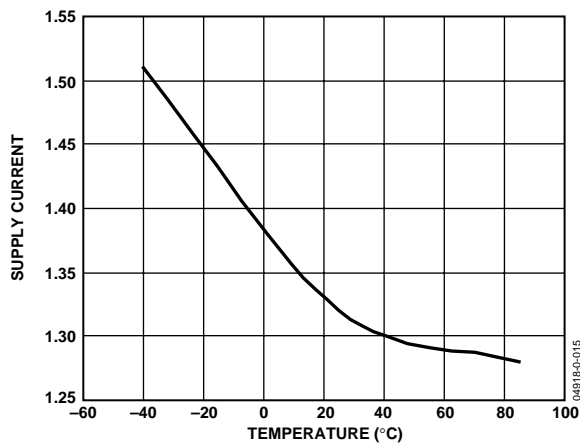

Figure 15. Supply Current vs. ADM1034 Temperature

ADM1034

FUNCTIONAL DESCRIPTION

The ADM1034 is a local- and remote-temperature monitor and fan controller for use in a variety of applications, including microprocessor-based systems. The device accurately monitors remote and ambient temperature and uses that information to quietly control the speed of a cooling fan. Whenever one of the fans stalls, the device asserts a `FAN_FAULT` output.

The ADM1034 features a `THERM` I/O. As an input, this measures assertions on the `THERM` pin. As an output, it asserts a low signal to indicate when the measured temperature exceeds the programmed `THERM` temperature. The ADM1034 communicates over an SMBus 2.0 interface. Its `LOCATION` input determines which version of SMBus to use, as well as the SMBus address (in fixed-and-discoverable mode) and the `LOCATION` bits in the UDID (in ARP-capable mode).

INTERNAL REGISTERS

Table 4 gives a brief description of the ADM1034's principal internal registers. For more detailed information on the function of each register, refer to Table 34.

SERIAL BUS INTERFACE

The ADM1034 communicates with the master via the 2-wire SMBus 2.0 interface. It supports two versions of SMBus 2.0, determined by the value of the `LOCATION` input's resistors.

The first version is fully ARP-capable. This means that it supports address resolution protocol (ARP), allowing the master to dynamically address the device on power-up. It responds to ARP commands such as "Prepare to ARP"

The second SMBus version, fixed-and-discoverable, is backwards-compatible with SMBus 1.0 and 1.1. In this mode, the ADM1034 powers up with a fixed address, which is determined by the state of the `LOCATION` pin on power-up. Note: When using the ADM1034, Addresses `0xC2` and `0xCA` should not be used by any other device on the bus.

LOCATION INPUT

The `LOCATION` input is a resistor divider input. It has multiple functions and can specify the SMBus version (in fixed-and-discoverable or ARP-capable modes); the SMBus address (in fixed-and-discoverable mode); and the LLL bits (in UDID in ARP-capable mode).

The voltage of this 8-level input is set by a potential divider. The voltage on `LOCATION` is sampled on power-up and digitized by the on-chip ADC to determine the `LOCATION` input value. Because the `LOCATION` input is sampled only at power-up, changes made while power is applied have no effect.

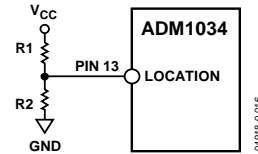

Figure 16. Bootstrapping the `LOCATION` Input

SMBus 2.0 ARP-CAPABLE MODE

In ARP-capable mode, the ADM1034 supports features such as address resolution protocol (ARP) and unique device identifier (UDID). The UDID is a 128-bit message that describes the ADM1034's capabilities to the master. The UDID also includes a vendor-specific ID for functionally equivalent devices.

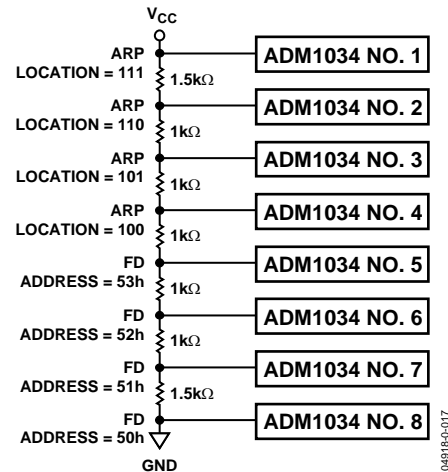

Figure 17. Setting Up Multiple ADM1034 Addresses in SMBus 2.0 ARP-Capable Mode

In SMBus 2.0 mode, this vendor-specific ID is generated by an on-chip random number generator. This should enable two adjacent ADM1034s in the same system to power up with a different vendor-specific ID, allowing the master to identify the two separate ADM1034s and assign a different address to each.

The state of the `LOCATION` input on power-up is also reflected in the UDID. This is useful when there is more than one ADM1034 in the system, so the master knows which one it is communicating with. The complete UDID is listed in Table 6.

The SMBus 2.0 master issues both general and directed ARP commands. A general command is directed at all ARP devices. A directed command is targeted at a single device once an address has been established. The PEC byte must be used for ARP commands. (Refer to the Packet Error Checking (PEC) section.) The ADM1034 responds to the following commands:

- Prepare to ARP (general)
- Reset device (general and directed)
- Get UDID (general and directed)
- Assign address (general)

Table 4. Internal Register Descriptions

Register	Description
Configuration	Provides control and configuration of various functions on the device.
Conversion Rate	Determines the number of measurements per second completed by the ADM1034.
Address Pointer	Contains the address that selects one of the other internal registers. When writing to the ADM1034, the first byte of data is always a register address, written to the address pointer register.
Status	Provides the status of each limit comparison.
Interrupt Mask	Allows the option to mask $\overline{\text{ALERT}}$ s due to particular out-of-limit conditions.
Value and Limit	Stores the results of temperature and fan speed measurements, along with their limit values.
Offset	Allows the local and remote temperature channel readings to be offset by a twos complement value written to them. These values are automatically added to the temperature values (or subtracted from them if negative). This allows the systems designer to optimize the system if required, by adding or subtracting up to 15.875°C from a temperature reading.
$\overline{\text{THERM}}$ Limit and Hysteresis	Contains the temperature value at which $\overline{\text{THERM}}$ is asserted and indicates the level of hysteresis.
Look-Up Table	Used to program the look-up table for the fan-speed-to-temperature profile.
$\overline{\text{THERM}}$ % Overtime and $\overline{\text{THERM}}$ % Limit	Reflects the state of the $\overline{\text{THERM}}$ input and monitors the duration of the assertion time of the signal as a percentage of a time window. The user can program the length of the time window.

Table 5. Resistor Ratios for Setting LOCATION Bits

Ideal Ratio R2/(R1 + R2)	R1 k Ω	R2 Ω	Actual R2/(R1 + R2)	Error %	SMBus Ver	SMBus Address	UDID LLL
N/A	0	O/C	1	0	ARP ¹	N/A	111
0.8125	18	82	0.82	+0.75	ARP ¹	N/A	110
0.6875	22	47	0.6812	-0.63	ARP ¹	N/A	101
0.5625	12	15	0.5556	-0.69	ARP ¹	N/A	100
0.4375	15	12	0.4444	+0.69	FD ¹	0x53	N/A
0.3125	47	22	0.3188	+0.63	FD ¹	0x52	N/A
0.1875	82	18	0.18	-0.75	FD ¹	0x51	N/A
N/A	O/C	0	0	0	FD ¹	0x50	N/A

¹ FD denotes fixed-and-discoverable mode, ARP denotes ARP-capable mode.

Table 6. UDID Values

Bit No.	Name	Function	Value
<127:120>	Device Capabilities	Describes the ADM1034's capabilities (for instance, that it supports PEC and uses a random number address device).	11000001
<119:112>	Version/Revision	UDID version number (Version 1) and silicon revision identification	00001010
<111:96>	Vendor ID	Analog Devices vendor ID number, as assigned by the SBS Implementer's Forum or the PCI SIG.	00010001 11010100
<95:80>	Device ID	Device ID.	00010000 00110100
<79:64>	Interface	Identifies the protocol layer interfaces supported by the ADM1034. This represents SMBus 2.0 as the Interface version..	00000000 00000100
<63:48>	Subsystem Vendor ID	Subsystem Vendor ID = 0 (subsystem fields are unsupported).	00000000 00000000
<47:32>	Subsystem Device ID	Subsystem Device ID = 0 (subsystem fields are unsupported).	00000000 00000000
<31:0>	Vendor Specific ID	A unique number per device. Contains LOCATION information (LL) and a 16-bit random number (x). See Table 5 for information on setting the LLL bits.	00000000 00000LLL xxxxxxx xxxxxxx

ADM1034

SMBus 2.0 FIXED-AND-DISCOVERABLE MODE

The ADM1034 also supports fixed-and-discoverable mode, which is backwards-compatible with SMBus 1.0 and 1.1. Fixed-and-discoverable mode supports all the same functionality as ARP-capable mode, except for *assign address*—in which case it powers up with a fixed address and is not changed by the assign address call. The fixed address is determined by the state of the LOCATION pin on power-up.

SMBus 2.0 READ AND WRITE OPERATIONS

The master initiates data transfer by establishing a start condition, defined as a high-to-low transition on the serial data line (SDA) while the serial clock line (SCL) remains high. This indicates that an address/data stream is to follow. All slave peripherals connected to the serial bus respond to the start condition and shift in the next 8 bits, which consist of a 7-bit address (MSB first) plus an R/W bit. This last bit determines the direction of the data transfer (whether data is written *to* or read *from* the slave device).

1. The peripheral that corresponds to the transmitted address responds by pulling the data line low during the low period before the 9th clock pulse, which is known as the acknowledge bit. All other devices on the bus remain idle while the selected device waits for data to be read from or written to it. If the R/W bit is a 0, the master writes to the slave device. If the R/W bit is a 1, the master reads from it.
2. Data is sent over the serial bus in sequences of 9 clock pulses—8 bits of data followed by an acknowledge bit from the slave device. Transitions on the data line must occur during the low period of the clock signal and remain stable during the high period, because a low-to-high transition when the clock is high may be interpreted as a stop signal. The number of data bytes that can be transmitted over the serial bus in a single read or write operation is limited only by what the master and slave devices can handle.
3. When all data bytes have been read or written, stop conditions are established. In write mode, the master pulls the data line high during the 10th clock pulse to assert a stop condition. In read mode, the master device overrides the acknowledge bit by pulling the data line high during the low period before the 9th clock pulse. This is known as *no acknowledge*. The master takes the data line low during the low period before the 10th clock pulse, then high during the 10th clock pulse to assert a stop condition.

It is not possible to mix read and write in one operation, because the type of operation is determined at the beginning and cannot be changed without starting a new operation.

To write data to one of the device data registers or to read data from it, the address pointer register (APR) must be set so that the correct data register is addressed; then data can be written into that register or read from it. The first byte of a write operation always contains an address that is stored in the APR. If data is to be written to the device, then the write operation contains a second data byte, which is written to the register selected by the APR.

As illustrated in Figure 18, the device address is sent over the bus, followed by R/W set to 0. This is followed by two data bytes. The first data byte is the address of the internal data register to be written to, which is stored in the APR. The second data byte is the data to be written to the internal data register.

When reading data from a register there are two possibilities.

If the ADM1034's APR value is unknown or incorrect, it must be set to the correct value before data can be read from the desired data register. To do this, perform a write to the ADM1034 as before, but send only the data byte containing the register. (See Figure 19.) A read operation is then performed, using the serial bus address and the R/W bit set to 1, followed by the data byte read from the data register. (See Figure 20.)

However, if the APR is already at the desired address, data can be read from the corresponding data register without first writing to the APR. In this case, Figure 19 can be omitted.

In Figure 18 to Figure 20, the serial bus address is determined by the state of the LOCATION pin on power-up.

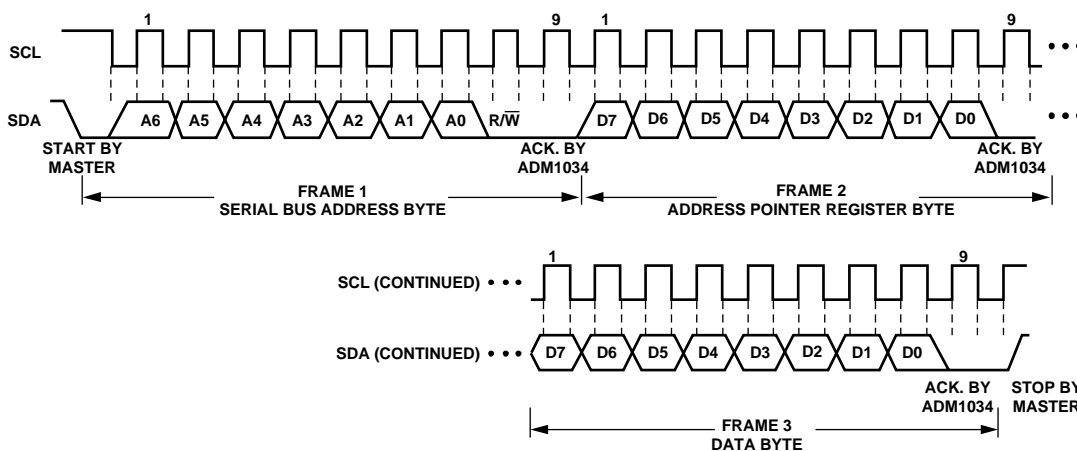

Figure 18. Writing a Register Address to the Address Pointer Register, then Writing Data to the Selected Register

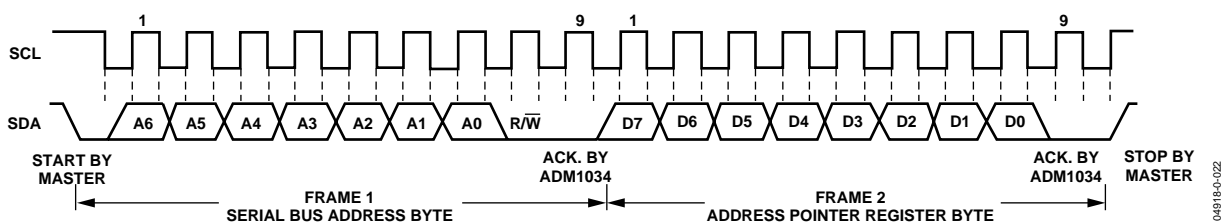

Figure 19. Writing to the Address Pointer Register Only (Send Byte)

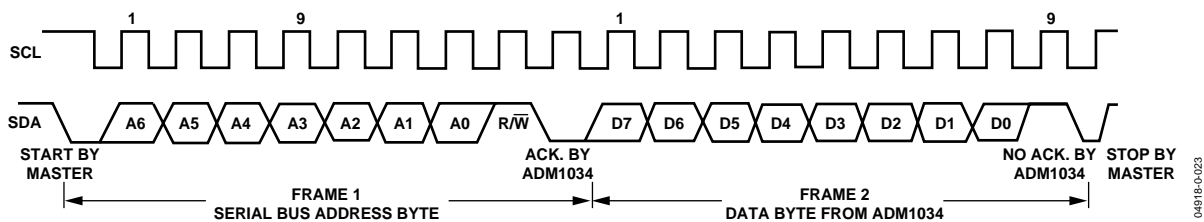

Figure 20. Reading Data from a Previously Selected Register

ADM1034

REGISTER ADDRESSES FOR SINGLE/BLOCK BYTE MODES

The ADM1034 supports single-byte as well as block read and write operations. The register address determines whether a single-byte or multiple-byte (block) operation is run. For a single-byte operation, the MSB of the register address is set to 0; for a multiple-byte operation, it is set to 1. The number of bytes read in a multiple-byte operation is set in the #Bytes/Block Read Register at Address 0x00. The number of bytes written to the ADM1034 is specified during the block-write operation. The addresses quoted in the register map and throughout this data sheet assume single-byte operation. For multiple-byte operations, set the MSB of each register address to 1.

WRITE OPERATIONS

The SMBus specifications define protocols for read and write operations. The ADM1034 supports send-byte, write-byte, and block-byte SMBus write protocols. The following abbreviations are used in the diagrams:

S—START

P—STOP

R—READ

W—WRITE

A—ACKNOWLEDGE

\bar{A} —NO ACKNOWLEDGE

Send Byte

In this operation, the master device sends a single-command byte to a slave device as follows:

1. The master device asserts a start condition on SDA.
2. The master sends a 7-bit address followed by the write bit (low).
3. The addressed slave device asserts ACK on SDA.
4. The master sends the register address.
5. The slave asserts ACK on SDA.
6. The master asserts a stop condition on SDA, and the transaction ends.

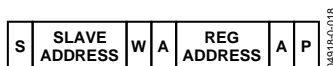

Figure 21. Send Byte

The ADM1034 uses the send-byte operation to write a register address to the APR for a subsequent read from the same address. (See Figure 24.) The user may be required to read data from the register immediately after setting up the address. If so, the master can assert a repeat start condition immediately after the final ACK and carry out a single-byte read without asserting an intermediate stop condition.

Write Byte

In this operation, the master device sends a register address and one data byte to the slave device as follows:

1. The master asserts a start condition on SDA.
2. The master sends the 7-bit slave address followed by a write bit (low).
3. The addressed slave device asserts ACK on SDA.
4. The master sends the register address. The MSB of the register address should equal 0 for a write-byte operation. If the MSB equals 1, a block-write operation takes place.
5. The slave asserts ACK on SDA.
6. The master sends a data byte.
7. The slave asserts ACK on SDA.
8. The master asserts a stop condition on SDA to end the transaction.



Figure 22. Write Byte Operation

Block Write

In this operation, the master device writes a block of data to a slave address as follows. A maximum of 32 bytes can be written.

1. The master asserts a start condition on SDA.
2. The master sends the 7-bit slave address followed by a write bit (low).
3. The addressed slave device asserts ACK on SDA.
4. The master sends the register address. The register address sets up the address pointer register and determines whether a block-write (MSB = 1) or a byte-write (MSB = 0) takes place.
5. The slave asserts ACK on SDA.
6. The master sends the byte count.
7. The slave asserts ACK on SDA.
8. The master sends N data bytes.
9. The slave asserts ACK on SDA after each byte.
10. The master asserts a stop condition on SDA to end the transaction.

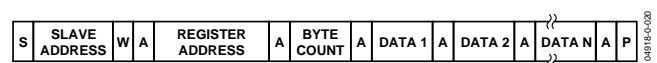

Figure 23. Block Write to RAM

READ OPERATIONS

Receive Byte

This is useful when repeatedly reading a single register. The register address must be set up prior to this, with the MSB at 0 to read a single byte. In this operation, the master device receives a single byte from a slave device as follows:

1. The master device asserts a start condition on SDA.
2. The master sends the 7-bit slave address followed by the read bit (high).
3. The addressed slave device asserts ACK on SDA.
4. The master receives a data byte.
5. The master sends NO ACK on SDA.
6. The master asserts a stop condition on SDA, and the transaction ends.

In the ADM1034, the receive-byte protocol is used to read a single byte from a register whose address has previously been set by a send-byte or write-byte operation.



Figure 24. Receive Byte

Block Read

In this operation, the master reads a block of data from a slave device. The number of bytes to be read must be set in advance. To do this, use a write-byte operation to the #Bytes/Block Read Register at Address 0x00. The register address determines whether a block-read or a read-byte operation is to be completed (set MSB to 1 to specify a block-read operation). A maximum of 32 bytes can be read.

1. The master asserts a start condition on SDA.
2. The master sends the 7-bit slave address followed by the write bit (low).
3. The addressed slave device asserts ACK on SDA.
4. The master sends the register address (MSB = 1).
5. The slave asserts ACK on SDA.
6. The master asserts a repeated start on SDA.
7. The master sends the 7-bit slave address followed by the read bit (high).
8. The slave asserts ACK on SDA.
9. The slave sends the byte count.
10. The master asserts ACK on SDA.
11. The slave sends N data bytes.
12. The master asserts ACK on SDA after each data byte.
13. The master does not acknowledge after the Nth data byte.
14. The master asserts a stop condition on SDA to end the transaction.



Figure 25. Block Read from RAM

SMBus TIMEOUT

The ADM1034 has a programmable SMBus timeout feature. When this is enabled, the SMBus typically times out after 25 ms of no activity. The timeout is disabled by default. It prevents hangups by releasing the bus after a period of inactivity.

To enable the SDA timeout, set the SDA timeout bit (Bit 5) of Configuration Register 1 (Address 0x01) to 1.

To enable the SCL timeout, set the SCL timeout bit (Bit 4) of Configuration Register 1 (Address 0x01) to 1.

PACKET ERROR CHECKING (PEC)

The ADM1034 also supports packet error checking (PEC). This optional feature is triggered by the extra clock for the PEC byte. The PEC byte is calculated using CRC-8. The frame check sequence (FCS) conforms to CRC-8 by the following:

$$C(x) = x^8 + x^2 + x + 1$$

For more information, consult www.SMBus.org.

ALERT RESPONSE ADDRESS (ARA)

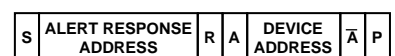

Figure 26. ALERT Response Address

When multiple devices exist on the same bus, the ARA feature allows an interrupting device to identify itself to the host.

The $\overline{\text{ALERT}}$ output can be used as an interrupt output or as an $\overline{\text{SMBusALERT}}$. One or more $\overline{\text{ALERT}}$ outputs can be connected to a common $\overline{\text{SMBusALERT}}$ line, connected to the master.

If a device's $\overline{\text{ALERT}}$ line goes low, the following occurs:

1. $\overline{\text{SMBusALERT}}$ is pulled low.
2. The master initiates a receive-byte operation and sends the alert response address (ARA 0001 100). This is a general call address that must not be used as a specific address.
3. The device with the low $\overline{\text{ALERT}}$ output responds to the ARA, and the master reads its device address. Once the address is known, it can be interrogated in the usual way.
4. If low $\overline{\text{ALERT}}$ output is detected in more than one device, the one with the lowest device address has priority, in accordance with normal SMBus arbitration.
5. Once the ADM1034 has responded to the ARA, it resets its $\overline{\text{ALERT}}$ output. However, if the error persists, the $\overline{\text{ALERT}}$ is re-asserted on the next monitoring cycle.

TEMPERATURE MEASUREMENT SYSTEM

INTERNAL TEMPERATURE MEASUREMENT

The ADM1034 contains an on-chip band gap temperature sensor. The on-chip ADC performs conversions on the sensor's output, outputting the data in 13-bit format. The resolution of the local temperature sensor is 0.03125°C.

Table 7 shows the format of the temperature data MSBs. Table 8 shows the same for the LSBs. To ensure accurate readings, read the LSBs first. This locks the current LSBs and MSBs until the MSBs are read. They then start to update again. (Reading only the MSBs does not lock the registers.) Temperature updates to the look-up table take place in parallel; so fan speeds may be updated even if the MSBs are locked.

Table 7. Temperature Data Format (Local Temperature and Remote Temperature High Bytes)

Temperature (°C)	Digital Output
-64°C	0000 0000
-40°C	0001 1000
-32°C	0010 0000
-2°C	0011 1110
-1°C	0011 1111
0°C	0100 0000
1°C	0100 0001
2°C	0100 0010
10°C	0100 1010
20°C	0101 0100
50°C	0111 0010
75°C	1000 1011
100°C	1010 0100
125°C	1011 1101
150°C	1101 0110
191°C	1111 1111

Table 8. Local and Remote Sensor Extended Resolution

Extended Resolution (°C)	Temperature Low Bits
0.0000	00000
0.03125	00001
0.0625	00010
0.125	00100
0.250	01000
0.375	01100
0.500	10000
0.625	10100
0.750	11000
0.875	11100

$$\text{Temperature } (^\circ\text{C}) = (\text{MSB} - 64^\circ\text{C}) + (\text{LSB} \times 0.03125)$$

Example: MSB = 0101 0100 = 84d

LSB = 11100 = 28

$$\text{Temperature } ^\circ\text{C} = (84 - 64) + (28 \times 0.03125) = 20.875$$

REMOTE TEMPERATURE MEASUREMENT

The ADM1034 can measure the temperature of two external diode sensors or diode-connected transistors, which are connected to Pins 9 and 10 and Pins 11 and 12. These pins are dedicated temperature input channels. The series resistance cancellation (SRC) feature can automatically cancel out the effect of up to 1 kΩ of resistance in series with the remote thermal diode.

The forward voltage of a diode or diode-connected transistor, operated at a constant current, exhibits a negative temperature coefficient of about -2 mV/°C. Unfortunately, the absolute value of V_{be} varies from device to device, and individual calibration is required to null this out. Therefore, the technique is unsuitable for mass production.

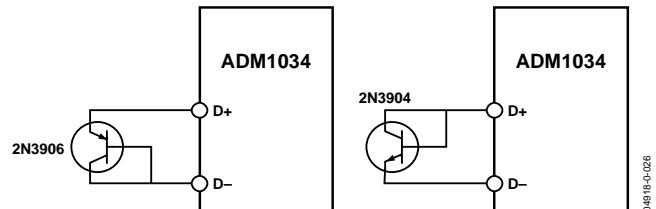

Figure 27. Measuring Temperature by Using Discreet Transistors

The ADM1034 operates at three different currents to measure the change in V_{be} . Figure 28 shows the input signal conditioning used to measure the output of an external temperature sensor. It also shows the external sensor as a substrate transistor, provided for temperature monitoring on some microprocessors. The external sensor could work equally well as a discrete transistor.

If a discrete transistor is used, the collector is not grounded, and should be linked to the base. If a PNP transistor is used, the base is connected to the D- input and the emitter to the D+ input. If an NPN transistor is used, the emitter is connected to the D- input and the base to the D+ input.

If the sensor is used in a very noisy environment, a capacitor value up to 1000 pF may be placed between the D+ and D- inputs to filter the noise. However, additional parasitic capacitance on the lines between D+, D-, and the thermal diode should also be considered. The total capacitance should never be greater than 1000 pF.

To measure each ΔV_{be} , the sensor is switched between operating currents of I , $(N1 \times I)$, and $(N2 \times I)$. The resulting waveform is passed through a 65 kHz low-pass filter to remove noise, then to a chopper-stabilized amplifier that amplifies and rectifies the waveform. This produces a dc voltage proportional to ΔV_{be} . These voltage measurements determine the temperature of the thermal diode, while automatically compensating for any series resistance on the D+ and/or D- lines. The temperature is stored in two registers as a 13-bit word.

To further reduce the effects of noise, digital filtering is performed by averaging the results of 16 measurement cycles at conversion rates of less than or equal to 8 Hz. An external temperature measurement takes nominally 32 ms when averaging is enabled and 6 ms when averaging is disabled.

One LSB of the ADC corresponds to 0.03125°C . The ADM1034 can theoretically measure temperatures from -64°C to $+191.96875^\circ\text{C}$, although these are outside its operating range. The extended temperature resolution data format is shown in Table 8. The data for the local and remote channels is stored in the extended temperature resolution registers (Reg. 0x40 = Local, Reg. 0x42 = Remote 1, and Reg. 0x44 = Remote 2).

Table 9. Temperature Measurement Registers

Register	Description	Default
0x40	Local Temperature, LSBs	0x00
0x41	Local Temperature, MSBs	0x00
0x42	Remote 1 Temperature, LSBs	0x00
0x43	Remote 1 Temperature, MSBs	0x00
0x44	Remote 2 Temperature, LSBs	0x00
0x45	Remote 2 Temperature, MSBs	0x00

High and low temperature limit registers are associated with each temperature measurement channel. Exceeding the programmed high and low limits sets the appropriate status bit. Exceeding either limit can cause an SMBusALERT interrupt.

Table 10. Temperature Measurement Limit Registers

Register	Description	Default
0x0B	Local High Limit	0x8B (75°C)
0x0C	Local Low Limit	0x54 (20°C)
0x0D	Local THERM Limit	0x95 (85°C)
0x0E	Remote 1 High Limit	0x8B (75°C)
0x0F	Remote 1 Low Limit	0x54 (20°C)
0x10	Remote 1 THERM Limit	0x95 (85°C)
0x11	Remote 2 High Limit	0x8B (75°C)
0x12	Remote 2 Low Limit	0x54 (20°C)
0x13	Remote 2 THERM Limit	0x95 (85°C)

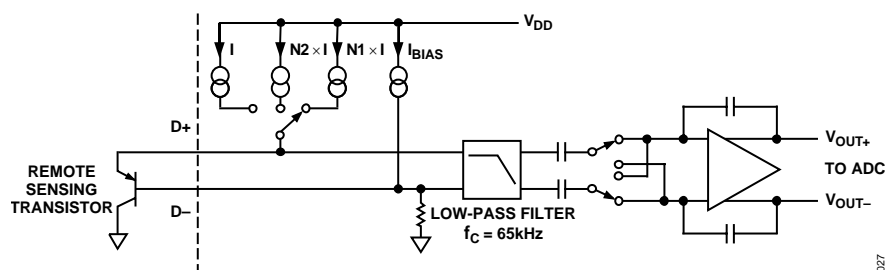

Figure 28. ADM1034 Signal Conditioning

04918-0-027

ADM1034

ADDITIONAL FUNCTIONS

Several other temperature measurement functions available on the ADM1034 offer the systems designer added flexibility.

Turn-off Averaging

The ADM1034 performs averaging at conversion rates of less than or equal to 8 conversions per second. This means that the value in the measurement register is the average of 16 measurements. For faster measurements, set the conversion rate to 16 conversions per second or greater. (Averaging is not carried out at these conversion rates.) Alternatively, switch off averaging at the slower conversion rates by setting Bit 1 (AVG) of Configuration 1 Register (Address 0x01).

Single-Channel ADC Conversions

In normal operating mode, the ADM1034 converts on three temperature channels: the local temperature channel, and the remote 1 and remote 2 channels. However, the user has the option to set up the ADM1034 to convert on one channel only. To enable single-channel mode, the user sets the round-robin bit (Bit 7) in Configuration Register 2 (Address 0x02) to 0. When the round-robin bit equals 1, the ADM1034 converts on all three temperature channels. In single-channel mode, it converts on one channel only, to be determined by the state of the channel selector bits (Bits 5 and 4) of the Configuration Register 2 (Address 0x02).

Table 11. Channel Selector

Bits 5:4	Channel Selector (Configuration 2)
00	Local Channel = Default
01	Remote 1 Channel
10	Remote 2 Channel
11	Reserved

Removing Temperature Errors

As CPUs run faster and faster, it gets more difficult to avoid high frequency clocks when routing the D+ and D– traces around a system board. Even when the recommended layout guidelines are followed, temperature errors attributed to noise coupled onto the D+ and D– lines remain. High frequency noise generally gives temperature measurements that are consistently too high. The ADM1034 has Local, Remote 1, and Remote 2 temperature offset registers at 0x16, 0x17, and 0x18—one for each channel. By completing a one-time calibration, the user can determine the offset caused by the system board noise and remove it using the offset registers. The registers automatically add a twos complement word to the remote temperature measurements, ensuring correct readings in the value registers.

Table 12. Offset Registers

Registration	Description	Default
0x16	Local Offset	0x00
0x17	Remote 1 Offset	0x00
0x18	Remote 2 Offset	0x00

Table 13. Offset Register Values

Code	Offset Value
0 0000 000	0°C (Default Value)
0 0000 001	0.125°C
0 0000 111	0.875°C
0 0001 111	1.875°C
0 0111 111	7.875°C
0 1111 111	15.875°C
1 0000 000	–16°C
1 1111 000	–0.875°C

LAYOUT CONSIDERATIONS

Digital boards can be electrically noisy environments. Try to protect the analog inputs from noise, particularly when measuring the very small voltages from a remote diode sensor. Take the following precautions:

- Place the ADM1034 as close as possible to the remote sensing diode. A distance of 4 inches to 8 inches is adequate, provided that the worst noise sources such as clock generators, data/address buses, and CRTs are avoided.
- Route the D+ and D– tracks close together, in parallel, with grounded guard tracks on each side. Provide a ground plane under the tracks if possible.
- Use wide tracks to minimize inductance and reduce noise pickup. At least 5 mil track width and spacing are recommended.



Figure 29. Arrangement of Signal Tracks

- Try to minimize the number of copper/solder joints, because they can cause thermocouple effects. Where copper/solder joints are used, make sure that they are in both the D+ and D– paths and at the same temperature. Thermocouple effects are not a major problem because 1°C corresponds to approximately 200 μV , and thermocouple voltages are approximately 3 $\mu\text{V}/^\circ\text{C}$ of temperature difference. Unless there are two thermocouples with a big temperature differential between them, the voltages should be much less than 200 μV .
- Place a 0.1 μF bypass capacitor close to the ADM1034.

- If the distance to the remote sensor is more than 8 inches, twisted pair cable is recommended. This works up to about 6 feet to 12 feet.
- For very long distances (up to 100 feet), use shielded twisted pair such as Belden #8451 microphone cable. Connect the twisted pair to D+ and D– and the shield to GND, close to the ADM1034. Leave the remote end of the shield unconnected to avoid ground loops.

Because the measurement technique uses switched current sources, excessive cable and/or filter capacitance can affect the measurement. When using long cables, the filter capacitor C1 may be reduced or removed. In any case, the total shunt capacitance should never exceed 1000 pF.

Noise Filtering

For temperature sensors operating in noisy environments, common practice is to place a capacitor across the D+ and D– pins to help combat the effects of noise. However, large capacitances affect the accuracy of the temperature measurement, leading to a recommended maximum capacitor value of 1000 pF. While this capacitor reduces the noise, it does not eliminate it, making it difficult to use the sensor in a very noisy environment.

The ADM1034 has a major advantage over other devices when it comes to eliminating the effects of noise on the external sensor. The series resistance cancellation feature allows a filter to be constructed between the external temperature sensor and the part. The effect of any filter resistance seen in series with the remote sensor is automatically cancelled from the temperature.

The construction of a filter allows the ADM1034 and the remote temperature sensor to operate in noisy environments. Figure 30 shows a low-pass R-C-R filter with the following values: $R = 100\ \Omega$ and $C = 1\ \text{nF}$. This filtering reduces both common-mode noise and differential noise.

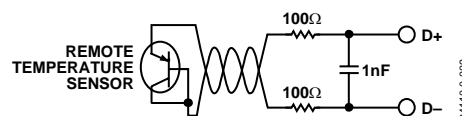

Figure 30. Filter between Remote Sensor and ADM1034

ADM1034

LIMITS, STATUS REGISTERS, AND INTERRUPTS

High and low limits are associated with each measurement channel on the ADM1034. These can form the basis of system status monitoring. A status bit can be set for any out-of-limit condition and detected by polling the device. Alternatively, $\overline{\text{SMBusALERT}}$ s can be generated to flag a processor or microcontroller of an out-of-limit condition.

8-BIT LIMITS

The following is a list of all the 8-bit limits on the ADM1034:

Table 14. Temperature Limit Registers

Register	Description	Default
0x0B	Local High Limit	0x8B (75°C)
0x0C	Local Low Limit	0x54 (20°C)
0x0D	Local $\overline{\text{THERM}}$ Limit	0x95 (85°C)
0x0E	Remote 1 High Limit	0x8B (75°C)
0x0F	Remote 1 Low Limit	0x54 (20°C)
0x10	Remote 1 $\overline{\text{THERM}}$ Limit	0x95 (85°C)
0x11	Remote 2 High Limit	0x8B (75°C)
0x12	Remote 2 Low Limit	0x54 (20°C)
0x13	Remote 2 $\overline{\text{THERM}}$ Limit	0x95 (85°C)

Table 15. $\overline{\text{THERM}}$ Limit Register

Register	Description	Default
0x19	$\overline{\text{THERM}}$ % Limit	0xFF default

OUT-OF-LIMIT COMPARISONS

The ADM1034 measures all parameters in a round-robin format and sets the appropriate status bit for out-of-limit conditions. Comparisons are made differently, depending on whether the measured value is compared to a high or low limit.

High Limit: \geq Comparison Performed

Low Limit: $<$ Comparison Performed

ANALOG MONITORING CYCLE TIME

The analog monitoring cycle time begins on power-up, or, if monitoring has been disabled, by writing a 1 to the monitor/STBY bit of Configuration Register 1, (Address 0x01). The ADC measures each one of the analog inputs in turn; as each measurement is completed, the result is automatically stored in the appropriate value register. The round-robin monitoring cycle continues unless it is disabled by writing a 0 to the monitor/STBY bit (Bit 0) of Configuration Register 1 (Address 0x01).

The ADC performs round-robin conversions and takes 11 ms for the local temperature measurement and 32 ms for each remote temperature measurement with averaging enabled.

The total monitoring cycle time for the average temperatures is therefore nominally

$$(2 \times 32) + 11 = 75 \text{ ms}$$

Once the conversion time elapses, the round robin starts again. For more information, refer to the Conversion Rate Register section.

Fan TACH measurements take place in parallel and are not synchronized with the temperature measurements in any way.

STATUS REGISTERS

The results of limit comparisons are stored in the status registers. A 1 represents an out-of-limit measurement; a 0 represents an in-limit measurement. The status registers are located at Addresses 0x4F to 0x51.

If the measurement is outside its limits, the corresponding status register bit is set to 1. It remains set at 1 until the measurement falls back within its limits and it is read or until an ARA is completed.

Poll the state of the various measurements by reading the status registers over the serial bus. If Bit 0 ($\overline{\text{ALERT}}$ low) of Status Register 3 (Address 0x51) is set, this means that the $\overline{\text{ALERT}}$ output has been pulled low by the ADM1034.

Pin 14 can be configured as a $\overline{\text{SMBusALERT}}$ output. This automatically notifies the system supervisor of an out-of-limit condition. Reading the status register clears the status bit as long as the error condition is gone.

Status register bits are sticky. Whenever a status bit is set due to an out-of-limit condition, it remains set—even after the triggering event has gone. The only way to clear the status bit is to read the status register (after the event has gone). Interrupt mask registers (Reg. 0x08, Reg. 0x09, Reg. 0x0A) allow individual interrupt sources to be masked from causing an $\overline{\text{ALERT}}$. However, if one of these masked interrupt sources goes out of limit, its associated status bit is set in the status register.

Table 16. Interrupt Status Register 1 (Reg. 0x4F)

Bit No.	Name	Description
7	LH	1 = Local high temperature limit has been exceeded.
6	LL	1 = Local low temperature limit has been exceeded.
5	R1H	1 = Remote 1 high temperature limit has been exceeded.
4	R1L	1 = Remote 1 low temperature limit has been exceeded.
3	R1D	1 = Remote 1 diode error; indicates an open or short on the D1+/D1- pins.
2	R2H	1 = Remote 2 high temperature limit has been exceeded.
1	R2L	1 = Remote 2 low temperature limit has been exceeded.
0	R2D	1 = Remote 2 diode error; indicates an open or short on the D2+/D2- pins.

Table 17. Status Register 2 (Reg. 0x50)

Bit No.	Name	Description
7	LT	1 = Local THERM temperature limit has been exceeded.
6	R1T	1 = Remote 1 THERM temperature limit has been exceeded.
5	R2T	1 = Remote 2 THERM temperature limit has been exceeded.
4	T%	1 = THERM % ontime limit has been exceeded.
3	TA	1 = One of the THERM limits has been exceeded; and the THERM output signal has been asserted.
2	TS	1 = THERM state. Indicates the THERM pin is active; clears on a read if THERM is not active. Does not generate an ALERT in ALERT comp mode.
1	Res	Reserved.
0	Res	Reserved.

Table 18. Status Register 3 (Reg. 0x51)

Bit No.	Name	Description
7	F1S	1 = Fan 1 has stalled.
6	FA	1 = Fan alarm speed. Fan1 and Fan 2 are running at alarm speed.
5	F2S	1 = Fan 2 has stalled.
4	Res	Reserved.
3	Res	Reserved.
2	Res	Reserved.
1	Res	Reserved.
0	ALERT	1 = ALERT low; indicates the ALERT line has been pulled low.

ALERT INTERRUPT BEHAVIOR

The ADM1034 generates an ALERT whenever an out-of-limit measurement is made (if it is not masked out). The user can also detect out-of-limit conditions by polling the ADM1034 status registers. It is important to note how the SMBus ALERT output behaves when writing interrupt handler software.

The ALERT output on the ADM1034 can be programmed to operate in either SMBusALERT mode or in comp mode.

In SMBusALERT mode, the ALERT output remains low until the measurement falls back within its programmed limits and either the status register is read or an ARA is completed. In comp mode, the ALERT output automatically resets once the temperature measurement falls back within the programmed limits.

Configuring the ALERT Output

For SMBusALERT mode, set the ALERT configuration bit (Bit 3) of the Configuration Register 1 (Address 0x01) to 0.

In SMBusALERT mode, a status bit is set when a measurement goes outside of its programmed limit. If the corresponding mask bit is not set, the ALERT output is pulled low. If the measured value falls back within the limits, the ALERT output remains low until the corresponding status register is read or until an ARA is completed (as long as no other measurement is outside its limits).

For comp mode, set the ALERT configuration bit (Bit 3) of Configuration Register 1 (Address 0x01) to 1.

In comp mode, the ALERT output is automatically pulled low when a measurement goes outside its programmed limits. Once the measurement falls back within its limits (and assuming no other measurement channel is outside its limits), the ALERT output is automatically pulled high again.

The main difference between the two modes is that the SMBusALERT does not reset without software intervention, whereas the comp mode ALERT output automatically resets.

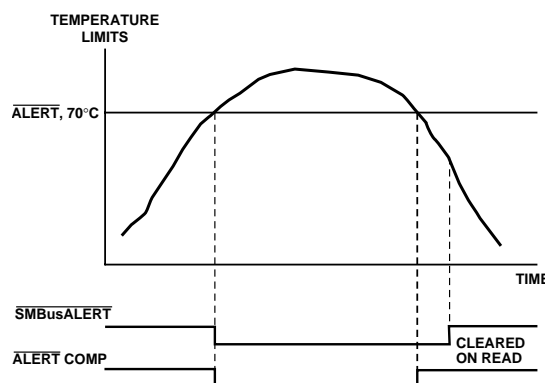
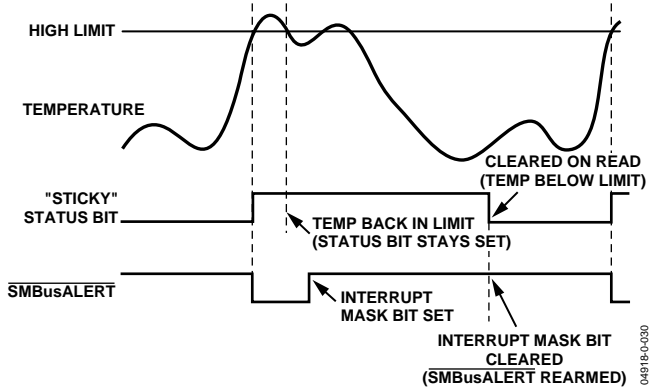

Figure 31. ALERT Comparator and SMBusALERT Outputs

ADM1034

HANDLING SMBusALERT INTERRUPTS



To prevent tie-ups due to service interrupts, follow these steps:

1. Detect an SMBus assertion.
2. Enter the interrupt handler.
3. Read the status register to identify the interrupt source.
4. Mask the interrupt source by setting the appropriate mask bit in the interrupt mask registers (from Reg. 0x08 to Reg. 0x0A).
5. Take the appropriate action for a given interrupt source.
6. Exit the interrupt handler.
7. Periodically poll the status register. If the interrupt status bit clears, reset the corresponding interrupt mask bit to 0. The $\overline{\text{SMBusALERT}}$ output and status bits then behave as shown in Figure 32.

INTERRUPT MASKING REGISTER

Mask Registers 1, 2, and 3 are located at Addresses 0x08, 0x09, and 0x0A. These allow individual interrupt sources to be masked out to prevent the $\overline{\text{SMBusALERT}}$ interrupts. Masking the interrupt source prevents only the $\overline{\text{SMBusALERT}}$ from being asserted; the appropriate status bit is still set as normal.

Table 19. Mask Register 1 (Reg. 0x08)

Bit No.	Name	Description
7	LH	1 masks the $\overline{\text{ALERT}}$ for the local high temperature.
6	LL	1 masks the $\overline{\text{ALERT}}$ for the local low temperature.
5	R1H	1 masks the $\overline{\text{ALERT}}$ for the Remote 1 high temperature.
4	R1L	1 masks the $\overline{\text{ALERT}}$ for the Remote 1 low temperature.
3	R1D	1 masks the $\overline{\text{ALERT}}$ for the Remote 1 diode errors.
2	R2H	1 masks the $\overline{\text{ALERT}}$ for the Remote 2 high temperature.
1	R2L	1 masks the $\overline{\text{ALERT}}$ for the Remote 2 low temperature.
0	R2D	1 masks the $\overline{\text{ALERT}}$ for the Remote 2 diode errors.

Table 20. Mask Register 2 (Reg. 0x09)

Bit No.	Name	Description
7	Res	Reserved.
6	Res	Reserved.
5	Res	Reserved.
4	T%	1 masks the $\overline{\text{ALERT}}$ for the $\overline{\text{THERM}}$ % ontime limit.
3	TA	1 masks the $\overline{\text{ALERT}}$ for the $\overline{\text{THERM}}$ limit being exceeded and the $\overline{\text{THERM}}$ output signal being asserted.
2	TS	1 masks the $\overline{\text{ALERT}}$ for the $\overline{\text{THERM}}$ state; has no effect on $\overline{\text{ALERT}}$ in $\overline{\text{ALERT}}$ comp mode.
1	Res	Reserved.
0	Res	Reserved.

Table 21. Mask Register 3 (Reg. 0x0A)

Bit No.	Name	Description
7	F1S	1 masks the $\overline{\text{ALERT}}$ for Fan 1 stalling.
6	FA	1 masks the $\overline{\text{ALERT}}$ for fans at $\overline{\text{ALARM}}$ speed.
5	F2S	1 masks the $\overline{\text{ALERT}}$ for Fan 2 stalling.
4	Res	Reserved.
3	Res	Reserved.
2	Res	Reserved.
1	Res	Reserved.
0	Res	Reserved.

FAN_FAULT OUTPUT

The $\overline{\text{FAN_FAULT}}$ output signals when one or both of the fans stall. Pin 8, the $\overline{\text{FAN_FAULT}}$ output, is a dual-function pin. It defaults to being a $\overline{\text{FAN_FAULT}}$ output but can be reconfigured as an analog input reference for the $\overline{\text{THERM}}$ input. To do this, set the $\overline{\text{FAN_FAULT/REF}}$ (Bit 7) in Configuration Register 4 (Address 0x04) to 1.

FAULT QUEUE

The ADM1034 has a programmable fault queue option that lets the user program the number of out-of-limit measurements allowable before generating an $\overline{\text{ALERT}}$. The fault queue affects only temperature measurement channels and is only operational in $\overline{\text{SMBusALERT}}$ mode. It performs some simple filtering, which is particularly useful at the higher conversion rates (16, 32, and 64 conversions/second), where averaging is not carried out.

There is a queue for each of the temperature channels. If L (the number programmed to the fault queue) or more consecutive out-of-limit readings are made on the same temperature channel, the fault queue fills, and the $\overline{\text{SMBusALERT}}$ output triggers. To fill the fault queue, one needs L or more consecutive out of limits on the internal temperature channel; L or more consecutive out-of-limits on the external 1 temperature channel; or L or more consecutive out-of-limits on the external 2 temperature channel. The fault queue is independent of the state of the bits in the $\overline{\text{ALERT}}$ status registers.

Table 22. Fault Queue Address 0x06

Bits <3:0>	Fault Queue
000X	1
001X	2
01XX	3
1XXX	4

To reset the fault queue, do one of the following:

- $\overline{\text{SMBus}}$ ARA Command
- Read Status Register 1
- Power-On Reset

The $\overline{\text{SMBusALERT}}$ clears, even if the condition that caused the $\overline{\text{SMBusALERT}}$ remains. The $\overline{\text{SMBusALERT}}$ is reasserted if the fault queue fills up.

CONVERSION RATE REGISTER

The ADM1034 makes up to 64 measurements per second. However, for the sake of reduced power consumption and better noise immunity, users may run the ADM1034 at a slower conversion rate. Better noise immunity results from the averaging that occurs at the slower conversion rates. Averaging does not occur at rates of 16, 32, or 64 conversions per second.

Table 23 lists the available conversion rates. Note that the current round-robin loop must be finished for conversion rates changes to take effect.

The conversion rate register is located at Address 0x05.

Table 23. Conversion Rates

Code	Conversion Rate
0x00	0.0625
0x01	0.125
0x02	0.25
0x03	0.5
0x04	1
0x05	2
0x06	4
0x07	8
0x08	16
0x09	32
0x0A	64
0x0B to 0xFF	Reserved

THERM I/O TIMER AND LIMITS

Pin 7 can be configured as either an input or output. As an output it is asserted low to signal that the measured temperature has exceeded preprogrammed temperature limits. The output is automatically pulled high again when the temperature falls below the $\overline{\text{THERM}}$ - Hys limit. The value of hysteresis is programmable in Register 0x1A. $\overline{\text{THERM}}$ is enabled as an output by default on power-up.

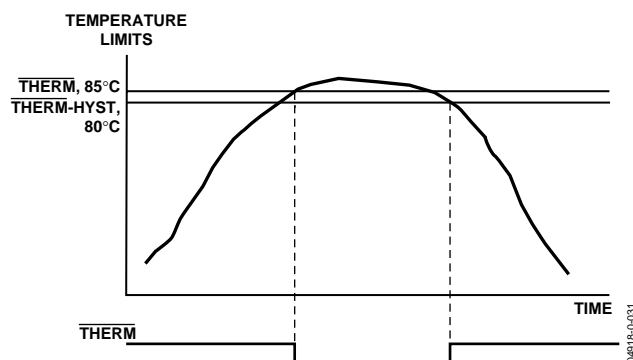

Figure 33. $\overline{\text{THERM}}$ Behavior

ADM1034

Once the $\overline{\text{THERM}}$ limits are exceeded, the fans are boosted to full speed—that is, as long as the Boost Disable Bit (Bit 1) is not set in Configuration Register 2 (Address 0x02).

To configure $\overline{\text{THERM}}$ as an input, the user must set the $\overline{\text{THERM}}$ timer bit (Bit 2) of Configuration Register 1 (Address 0x01) to 1. (It no longer operates as an output.) The ADM1034 can then detect when the $\overline{\text{THERM}}$ input is asserted low. This may be connected to a trip point temperature sensor or to the $\overline{\text{FAN_FAULT_PROCHOT}}$ output of a CPU. With processor core voltages reducing all the time, the threshold for the AGTL+ $\overline{\text{PROCHOT}}$ output also reduces down as new processors become available. The default threshold on the input is the normal CMOS threshold. However, Pin 8 ($\overline{\text{FAN_FAULT/REF}}$) can also be reconfigured as a REF input. This is done by setting Bit 7 ($\overline{\text{FAN_FAULT/REF}}$) in Configuration Register 4 (Address 0x04). Connect the processor V_{CCP} to this input to provide a reference for the $\overline{\text{THERM}}$ input. The resulting $\overline{\text{THERM}}$ threshold is $0.75 \times V_{\text{CCP}}$, which is the correct threshold for an AGTL+ signal.

The ADM1034 also measures assertion times on the $\overline{\text{THERM}}$ input as a percentage of a time window. This time window is programmable in Configuration Register 4 (Address 0x04) by using Bits <6:4> ($\overline{\text{THERM}}$ % Time Window). Values between 0.25 seconds and 8 seconds are programmable. The assertion time as a percentage of the time window is stored in the $\overline{\text{THERM}}$ % On-Time Register (Address 0x4E).

A $\overline{\text{THERM}}$ % limit is also associated with this register. Once the measured percentage exceeds the percentage limit, the $\overline{\text{THERM}}$ % Exceeded Bit (Bit 4) in Status Register 2 (Address 0x50) is asserted and an $\overline{\text{ALERT}}$ is generated, that is, if the mask bit is not set. If the limit is set to 0x00, an $\overline{\text{ALERT}}$ is generated on the first assertion. If the limit is set to 0xFF, an $\overline{\text{ALERT}}$ is never generated. This is because 0xFF corresponds to the $\overline{\text{THERM}}$ input, which is asserted continuously.

Table 24. $\overline{\text{THERM}}$ % On-Time Window

Code	$\overline{\text{THERM}}$ % On-Time Window
000	0.25 s
001	0.5 s
010	1 s
011	2 s
100	4 s
101	8 s
110	8 s
111	8 s

When $\overline{\text{THERM}}$ is configured as an input only, setting the Enable $\overline{\text{THERM}}$ Events bits in Configuration Register 4 allows Pin 7 to operate as an I/O.

The user can configure the $\overline{\text{THERM}}$ pin to be pulled low as an output whenever the local temperature exceeds the local $\overline{\text{THERM}}$ limit. To do this, set the Enable Local $\overline{\text{THERM}}$ events bit (Bit 0) of Configuration Register 4 (Address 0x04).

The user can also configure the $\overline{\text{THERM}}$ pin to be pulled low as an output whenever the Remote 1 temperature exceeds the Remote 1 $\overline{\text{THERM}}$ limit. Set the Enable Remote 1 $\overline{\text{THERM}}$ events bit (Bit 1) of Configuration Register 4 (Address 0x04).

The last option is to configure the $\overline{\text{THERM}}$ pin to be pulled low as an output whenever the Remote 2 temperature exceeds the Remote 2 $\overline{\text{THERM}}$ limit. Set the Enable Remote 2 $\overline{\text{THERM}}$ events bit (Bit 2) of Configuration Register 4 (Address 0x04).

$\overline{\text{THERM}}$ % LIMIT REGISTER

The $\overline{\text{THERM}}$ % limit is programmed to Register 0x19. An $\overline{\text{ALERT}}$ is generated, if $\overline{\text{THERM}}$ is asserted for longer than the programmed percentage limit. The limit is programmed as a percentage of the chosen time window.

$\overline{\text{THERM}}$ % limit register is an 8-bit register.

0x00 = 0%

0xFF = 100%

Therefore, 1 LSB = 0.39%.

Example

If a time window of 8 seconds is chosen, and an $\overline{\text{ALERT}}$ is to be generated if $\overline{\text{THERM}}$ is asserted for more than 1 second, program the following value to the limit register:

$$\% \text{ Limit} = 1/8 \times 100 = 12.5\%$$

$$12.5\% / 0.39\% = 32d = 0x20 = 0010\ 0000$$

An $\overline{\text{ALERT}}$ is generated if the $\overline{\text{THERM}}$ limit is exceeded *after* the time window has elapsed, assuming it is not masked.

FAN DRIVE SIGNAL

The ADM1034 controls the speed of up to two cooling fans. Varying the duty cycle (on/off time) of a square wave applied to the fan varies the speed of the fan. The ADM1034 uses a control method called *synchronous speed control*, in which the PWM drive signal applied to the fan is synchronized with the fan's TACH signal. See the Synchronous Speed Control section for more information.

The external circuitry required to drive the fan is very simple. A single N-channel MOSFET is the only drive device required. The specifications of the MOSFET depend on the maximum current required by the fan and the gate voltage drive ($V_{GS} < 3\text{ V}$ for direct interfacing to the drive pin). V_{GS} can be greater than 3 V, as long as the pull-up on the gate is tied to 5 V. The MOSFET should also have a low on-resistance to ensure that there is no significant voltage drop across the FET. A high on-resistance reduces the voltage applied across the fan and therefore the maximum operating speed of the fan. Figure 34 shows a scheme for driving a 3-wire fan.

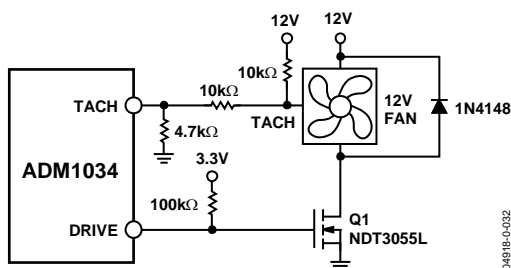

Figure 34. Interfacing a 3-Wire Fan to the ADM1034 by Using an N-Channel MOSFET

Figure 34 uses a 10 kΩ pull-up resistor for the TACH signal. This assumes that the TACH signal is an open collector from the fan. In all cases, the fan's TACH signal must be kept below 5 V maximum to prevent damaging the ADM1034.

If in doubt as to whether a fan has an open-collector or totem-pole TACH output, use one of the input signal conditioning circuits shown in the Fan Inputs section.

When designing drive circuits with transistors and FETs, make sure that the drive pins are not required to source current and that they sink less than the maximum current specified here.

SYNCHRONOUS SPEED CONTROL

The ADM1034 drives the fan by using a control scheme called synchronous speed control. In this scheme, the PWM drive signal applied to the fan is synchronized with the TACH signal. Accurate and repeatable fan speed measurements are the main benefits. The fan is allowed to run reliably at speeds as low as 30 percent of the full capability.

The drive signal applied to the fan is synchronized with the TACH signal. The ADM1034 switches on the drive signal and waits for a transition on the TACH signal. When a transition takes place on the TACH signal, the PWM drive is switched off for a period of time called *toff*. The drive signal is then switched on again. The toff time is varied in order to vary the fan speed. If the fan is running too fast, the toff time is increased. If the fan is running too slow, the toff time is decreased.

Since the drive signal is synchronized with the TACH signal, the frequency with which the fan is driven depends on the current speed of the fan and the number of poles in it.

Figure 35 shows how the synchronous speed drive signal works. The ideal TACH signal is the TACH signal that would be output from the fan if power were applied 100 percent of the time. It is representative of the actual speed of the fan. The actual TACH signal is the signal the user would see on the TACH output from the fan if the user were to put a scope on it. In effect, the actual TACH signal is the ideal TACH signal chopped with the drive signal.

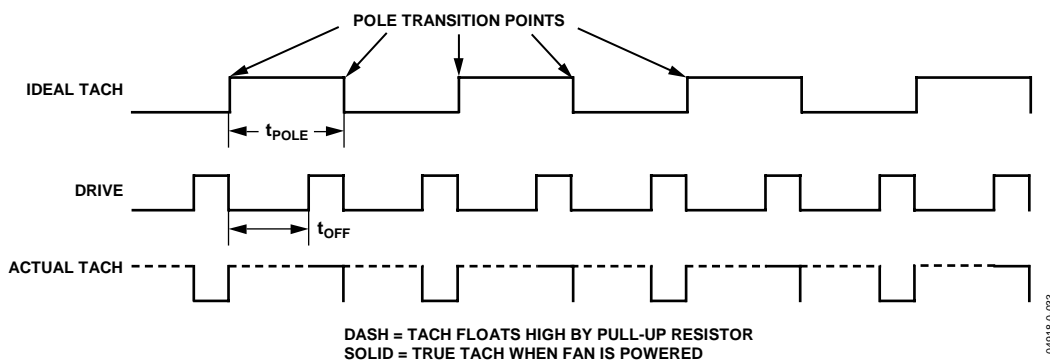

Figure 35. Drive Signal by Using Synchronous Control

ADM1034

FAN INPUTS

Pin 2 and Pin 4 are TACH inputs intended for fan speed measurement. These inputs are open-drain.

Signal conditioning on the ADM1034 accommodates the slow rise and fall time of typical tachometer outputs. The maximum input signal range is from 0 V to 5 V, even when V_{CC} is less than 5 V. In the event that these inputs are supplied from fan outputs exceeding 0 V to 5 V, either resistive attenuation of the fan signal or diode clamping must be used to keep the fan inputs within an acceptable range.

Figure 36 to Figure 39 show examples of possible fan input circuits. If the fan TACH has a resistive pull-up to V_{CC} , it can be connected directly to the fan output.

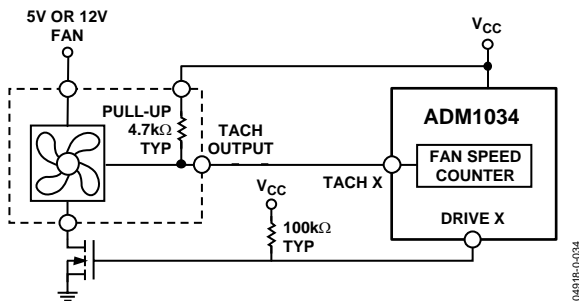
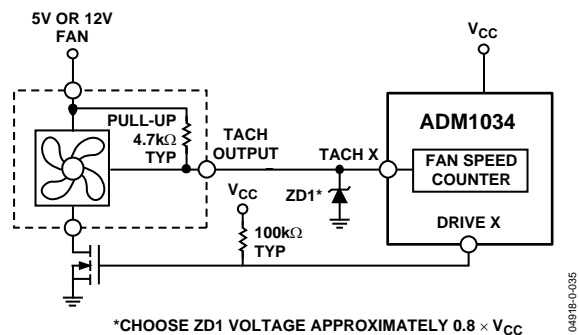

Figure 36. Fan with TACH Pull-Up to $+V_{CC}$

If the fan output has a resistive pull-up to 12 V (or another voltage greater than 5 V), the fan output can be clamped with a Zener diode, as shown in Figure 37. The Zener voltage should be chosen so that it is greater than V_{IH} but less than 5 V. Allowing for the voltage tolerance of the Zener, a value of between 3 V and 5 V is suitable.



*CHOOSE ZD1 VOLTAGE APPROXIMATELY $0.8 \times V_{CC}$

Figure 37. Fan with TACH Pull-Up to Voltage > 5 V, Clamped with Zener Diode

If the fan has a strong pull-up (less than 1 k Ω to +12 V) or a totem-pole output, a series resistor can be added to limit the Zener current, as shown in Figure 38. Alternatively, a resistive attenuator may be used, as shown in Figure 39.

R_1 and R_2 should be chosen such that

$$2 \text{ V} < V_{PULLUP} \times R_2 / (R_{PULLUP} + R_1 + R_2) < 5 \text{ V}$$

The fan inputs have an input resistance of nominally 160 k Ω to ground. This should be taken into account when calculating resistor values.

With a pull-up voltage of 12 V and pull-up resistor less than 1 k Ω , suitable values for R_1 and R_2 would be 100 k Ω and 47 k Ω . This gives a high input voltage of 3.83 V.

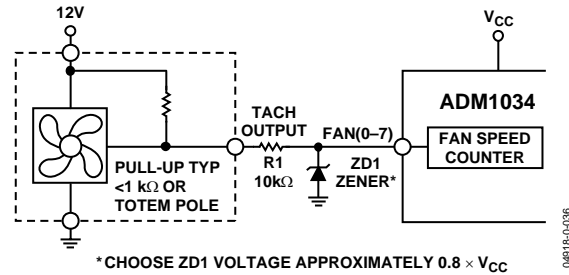

*CHOOSE ZD1 VOLTAGE APPROXIMATELY $0.8 \times V_{CC}$

Figure 38. Fan with Strong TACH. Pull-Up to $>V_{CC}$ or Totem-Pole Output, Clamped with Zener and Resistor.

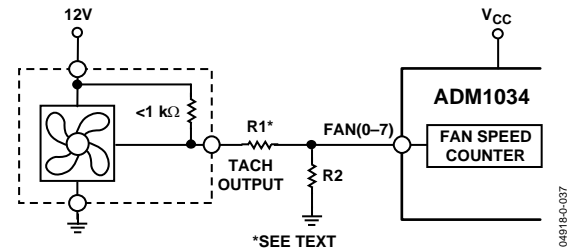

*SEE TEXT

Figure 39. Fan with Strong TACH. Pull-Up to $>V_{CC}$ or Totem-Pole Output, Attenuated with R_1/R_2 .

FAN SPEED MEASUREMENT

The fan counter does not count the fan TACH output pulses directly. This is because the fan may be spinning at less than 1000 rpm and it would take several seconds to accumulate a reasonably large and accurate count. Instead, the period of the fan revolution is measured by gating an on-chip 81.92 kHz oscillator into the input of a 16-bit counter for one complete revolution of the fan. Therefore, the accumulated count is actually proportional to the fan tachometer period and inversely proportional to the fan speed.

The number of poles in the fan must be programmed in Configuration Register 3 (Address 0x03). Bits $<3:0>$ set the number of poles for Fan 1, and Bits $<7:4>$ set the number of poles for Fan 2. This number must be an even number only, because there cannot be an uneven number of poles in a fan. A TACH period is output for every two poles. Therefore, the number of poles must be known so that the ADM1034 can measure for a full revolution.

Figure 40 shows the fan speed measurement period, assuming that the fan outputs an ideal TACH signal. In reality, the TACH signal output by the fan is chopped by the drive signal. However, since the drive and the TACH signal are synchronized, there is enough information available for the ADM1034 to measure the fan speed accurately.

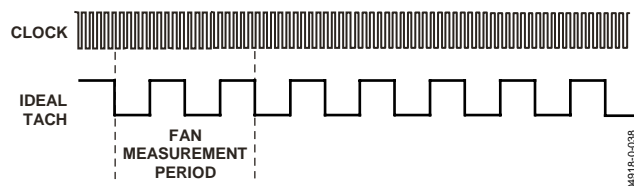

Figure 40. Fan Speed Measurement for a 4-Pole Fan

FAN SPEED MEASUREMENT REGISTERS

These 16-bit measurements are stored in the TACH value registers.

Table 25. TACH Value Registers

Register	Description	Default
0x4A	TACH1 Period, LSB	0xFF
0x4B	TACH1 Period, MSB	0xFF
0x4C	TACH2 Period, LSB	0xFF
0x4D	TACH2 Period, MSB	0xFF

READING FAN SPEED

Reading back fan speeds involves a 2-register read for each measurement. The low byte should be read first. This freezes the high byte until both high and low byte registers have been read, preventing erroneous fan speed measurement readings.

The fan tachometer reading registers report back the number of 12.2 μs period clocks (81.92 kHz oscillator) gated to the fan speed counter, for one full rotation of the fan, assuming the correct number of poles is programmed. Since the ADM1034 essentially measures the fan TACH period, the higher the count value, the slower the actual fan speed. A 16-bit fan TACH reading of 0xFFFF indicates that the fan has stalled or is running very slowly (< 75 rpm).

CALCULATING FAN SPEED

Fan speed in rpm is calculated as follows. This assumes that the number of poles programmed in the Configuration Register 3 (Address 0x03) is correct for both fans.

$$\text{Fan Speed (RPM)} = (81920 \times 60) / \text{Fan TACH Reading}$$

where:

$$\text{Fan TACH Reading} = \text{16-bit Fan TACHometer Reading}$$

Example

$$\text{TACH1 High Byte (Reg. 0x28)} = 0x17$$

$$\text{TACH1 Low Byte (Reg. 0x29)} = 0xFF$$

What is Fan 1 speed in rpm?

$$\text{Fan 1 TACH Reading} = 0x17FF = 6143d$$

$$\text{RPM} = (f \times 60) / \text{Fan 1 TACH reading}$$

$$\text{RPM} = (81920 \times 60) / 6143$$

$$\text{Fan Speed} = 800 \text{ RPM}$$

ALARM SPEED

The fan ALARM speed (Bit 6) in Status Register 3 (Address 0x51) is set whenever the fan runs at alarm speed. This occurs if the device is programmed to run the fan at full speed whenever the THERM temperature limits are exceeded. The device runs at alarm speed, for example, if the Boost Disable bit (Bit 1) of the Configuration 2 Register (Address 0x02) is not set to 1.

Fan Response Register

The ADM1034 fan speed controller operates by reading the current fan speed, comparing it with the programmed fan speed, and then updating the drive signal applied to the fan. The rate at which the ADM1034 looks at and updates the drive signal is determined by the fan response register. Different fans have different inertias and respond to a changing drive signal more or less quickly than others. The fan response register allows the user to tailor the ADM1034 to a particular fan to prevent situations like overshoot.

The user programs the number of updates the ADM1034 can make to the drive signal per second. Table 26 lists the available options.

Table 26. Fan Response Codes

Code	Update Rate
000	1.25 updates/second
001	2.5 updates/second = default
010	5 updates/second
011	10 updates/second
100	20 updates/second
101	40 updates/second
110	80 updates/second
111	160 updates/second

Table 27. Fan Response Register (Address 0x3C)

Bit No.	Function
7	Reserved
<6:4>	Fan 2 Response
3	Reserved
<2:0>	Fan 1 Response

ADM1034

LOOK-UP TABLE: MODES OF OPERATION

The ADM1034 look-up table has two different modes of operation used to determine the behavior of the system:

- Manual mode
- Look-up table

Manual Mode

In manual mode, the ADM1034 is under software control. The software can program the required fan speed value or the target fan speed to the ADM1034, which then outputs that fan speed.

Programming Target Fan Speed

In this mode, the user programs the target fan speed as a TACH count for N poles or a TACH count for one full rotation of the fan, assuming the number of poles is programmed correctly in the Configuration 3 Register (Address 0x03).

Use the following steps to program the target fan speed:

1. Place the ADM1034 into manual mode. Set Bit 7 (Table/SW) of Configuration Register 1 (Address 0x01) = 0.
2. Program the target TACH count (fan speed) using the following equation:

$$TACH\ Count = (f \times 60) / R$$

where:

$$f = \text{clock frequency} = 81.92\ \text{kHz}$$

R = required RPM value

Example 1: If the desired speed for Fan 1 is 5000 rpm, program the following value to the TACH count registers:

$$TACH\ Count = (f \times 60) / 5000$$

$$TACH\ Count = 983d = 0x03D7$$

Example 2: If the desired speed for Fan 2 is 3500 rpm, program the following value to the TACH pulse period registers:

$$TACH\ Count = (f \times 60) / 3500$$

$$TACH\ Count = 1404d = 0x057C$$

Table 28. Registers to be Programmed

Fan	Description	Address	Value
Fan 1	Look-Up Table FS1, LSB	0x2A	0xD7
Fan 1	Look-Up Table FS1, MSB	0x2B	0x03
Fan 2	Look-Up Table FS2, LSB	0x2C	0x7C
Fan 2	Look-Up Table FS2, MSB	0x2D	0x05

Look-Up Table

The ADM1034 allows the user to program a temperature-to-fan-speed profile. There are 24 registers in the look-up table—eight for temperature and 16 for target fan speed (each target fan speed is two registers). In total, there are eight available points. In the default configuration, four of these are for Fan 1 and four are for Fan 2. However, it can be configured such that eight points are available and both fans run from the same table.

There are two options when programming the look-up table. The ADM1034 can be programmed to make the fan speed run at discrete speeds and jump to the new fan speed once the temperature threshold is crossed. Or, it can linearly ramp the TACH count between the two temperature thresholds.

Figure 41 and Figure 42 show what the look-up table looks like if all eight points are used on the one curve for both fans.

Figure 41 shows the transfer curve when the fan is programmed to run at discrete speeds. The ADM1034 spins the fan at its new speed once a threshold is crossed.

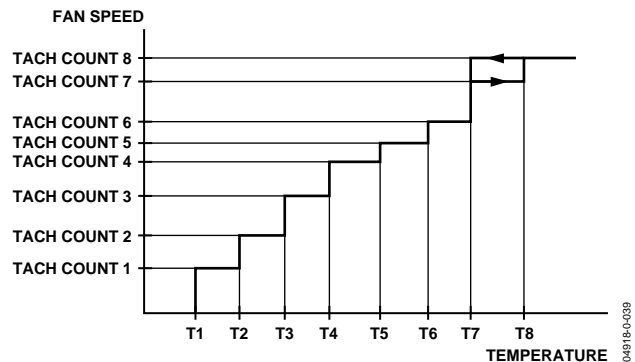

Figure 41. Programming the Look-Up Table in Discreet Fan Speeds Mode

Figure 42 shows the transfer curve if the Linear Fan Speeds option is chosen. At temperature T1, the fan runs at Fan Speed 1. As the temperature increases, the fan speed increases until it reaches Fan Speed 2 at T2.

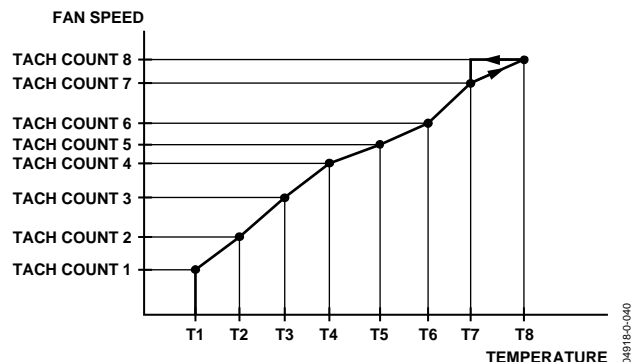

Figure 42. Programming the Look-Up Table in Linear Fan Speeds Mode

Once the temperature exceeds the highest temperature point in the look-up table, the fan speed remains at the highest speed until the temperature drops below the T7 temperature value. When the look-up table is split in two, the same applies.

If the temperatures in T1 to T8 are not programmed in succession, the fan speed moves to the next highest programmed temperature as the temperature increases. Similarly, when the temperature decreases, it ignores programmed higher temperatures and jumps to the next lower temperature. Therefore, the temperature-to-fan-speed profile for increasing and decreasing temperature can be different.

When programming the look-up table, the user has the option to use between two and eight points for each fan (eight points only if the same curve is to be used for both fans). If the user just wants to program a transfer curve (and knows the starting temperature, minimum speed, maximum temperature, and maximum speed), then all the user needs to program are four parameters—T1, T2, FS1, and FS2. The remainder of the look-up temperature thresholds should remain at their default values of +191°C. If required, the FS3 should be programmed with the same value as FS2 to give the flat curve, if required. Or, the fan speeds can be left at the default value of 0. However, it is normal to program a THERM limit as well. Once this temperature is exceeded and the boost bit is set, the fans run to full speed. This overrides the look-up table.

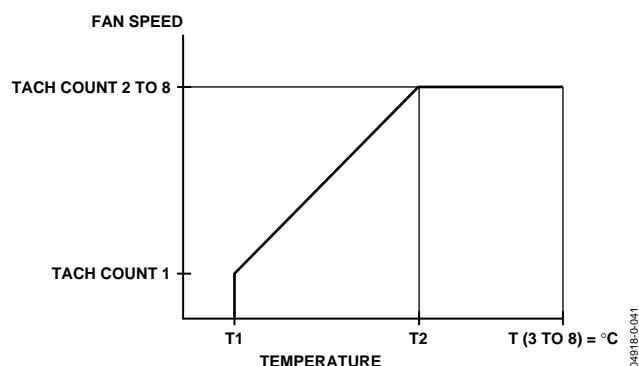

Figure 43. Programming Two Points on the Look-Up Table

Table 29. Look-Up Table Register Addresses

x	Temperature, x	FSx, LSB	FSx, MSB
1	0x22	0x2A	0x2B
2	0x23	0x2C	0x2D
3	0x24	0x2E	0x2F
4	0x25	0x30	0x31
5	0x26	0x32	0x33
6	0x27	0x34	0x35
7	0x28	0x36	0x37
8	0x29	0x38	0x39

SETTING UP THE SIZE OF THE LOOK-UP TABLE

When 4:8 Look-Up (Bit 3) is set to 0 (default), four points are used for each fan.

When 4:8 Look-Up (Bit 3) is set to 1, all eight points on the table are used for both fans.

SETTING UP THE LOOK-UP TABLE IN LINEAR MODE

When Discrete/Linear Speed (Bit 2) is set to 1 (default), the TACH count decreases linearly (and therefore the fan speed increases) with temperature.

Example: At temperature T_x , the fans run at FS_x and fan speed increases with temperature to FS_{x+1} at temperature T_{x+1} .

Alternatively, the fan can be run at discrete fan speeds. When Discrete/Linear Speed (Bit 2) is set to 0, the fan runs at a new speed once the temperature threshold is exceeded.

SETTING WHICH TEMPERATURE CHANNEL CONTROLS A FAN

Fan Behavior Register (Address 0x07)

Bits <1:0> = DRIVE1 Behavior (D1B)

Bits <3:2> = DRIVE2 Behavior (D2B)

The ADM1034 can be configured so that Fan 1 or Fan 2 can be controlled by either the local temperature, or by the Remote 1 or Remote 2 temperatures.

Table 30. Drive X BHVR Bits

Bits	DRIVE x BHVR
00	Local Temperature Controls Fan x
01	Remote 1 Temperature Controls Fan x
10	Remote 2 Temperature Controls Fan x
11	Fan x Runs at Full Speed

By default, Remote 1 controls Fan 1, and Remote 2 controls Fan 2. If the ADM1034 is in single-channel mode and one of the fans is set up to run from a temperature channel that is not being measured, the drive X BHVR bits are set to 11 and the fan is run at full speed.

LOOK-UP TABLE HYSTERESIS

The user can program a hysteresis to be applied to the look-up table. The advantage of this is apparent if the temperature is cycling around one of the threshold temperatures and causing the fan speed to switch between the two speeds, particularly when the look-up table is configured in discrete mode. It would not be as important in the linear mode.

ADM1034

Programming the Look-Up Table Hysteresis

The look-up table's hysteresis register is at Address 0x3A. A hysteresis value of between 0°C and 15°C can be programmed with a resolution of 1°C and applied to all the temperature thresholds. Table 31 gives examples of values for programming.

Table 31. Programming the Hysteresis

Code	Hysteresis Value
0000 0000	0°C
0000 0001	1°C
0000 0010	2°C
0000 0101	5°C = Default
0000 1000	8°C
0000 1111	15°C

PROGRAMMING THE THERM LIMIT FOR EACH TEMPERATURE CHANNEL

$\overline{\text{THERM}}$ is the absolute maximum temperature allowed on a temperature channel. Above this temperature, a component such as the CPU or VRM may be operating beyond its safe operating limit. When the temperature measured exceeds $\overline{\text{THERM}}$, all fans are driven at full speed to provide critical system cooling. The fans remain running at full speed until the temperature drops below $\overline{\text{THERM}}$ - Hysteresis. The hysteresis value is programmable; its default is 5°C. If the Boost Disable bit (Bit 1) is set in Configuration Register 2, the fans do not run to full speed.

The $\overline{\text{THERM}}$ limit is considered the maximum worst-case operating temperature of the system. Exceeding any $\overline{\text{THERM}}$ limit runs all fans at full speed, a condition with very negative acoustic effects. This limit should be set up as a fail-safe and not exceeded under normal system operating conditions.

The $\overline{\text{THERM}}$ temperature limit registers are listed in Table 32.

Table 32. $\overline{\text{THERM}}$ Hysteresis Registers

Address	Description	Default
0x0D	Local $\overline{\text{THERM}}$ Limit	0x95 (85°C)
0x10	Remote 1 $\overline{\text{THERM}}$ Limit	0x95 (85°C)
0x13	Remote 2 $\overline{\text{THERM}}$ Limit	0x95 (85°C)

The $\overline{\text{THERM}}$ hysteresis register is at Address 0x1A. A hysteresis value is programmed and applied to all three temperature channels—Local, Remote 1, and Remote 2. A $\overline{\text{THERM}}$ hysteresis value of between 0°C and 15°C can be programmed with a resolution of 1°C. Table 33 gives some examples.

Table 33. Programming $\overline{\text{THERM}}$ Hysteresis

Code	Hysteresis Value
0000 0000	0°C
0000 0001	1°C
0000 0010	2°C
0000 0101	5°C = Default
0000 1000	8°C
0000 1111	15°C

XOR TREE TEST MODE

The ADM1034 includes an XOR tree test mode. This is useful for in-circuit test equipment at board-level testing. By applying stimulus to the pins included in the XOR test, it is possible to detect opens or shorts on the system board. Figure 44 shows the signals that are exercised in the XOR tree test mode. The XOR tree test is enabled by setting the XOR bit (Bit 3) in Configuration Register 4 (0x04).

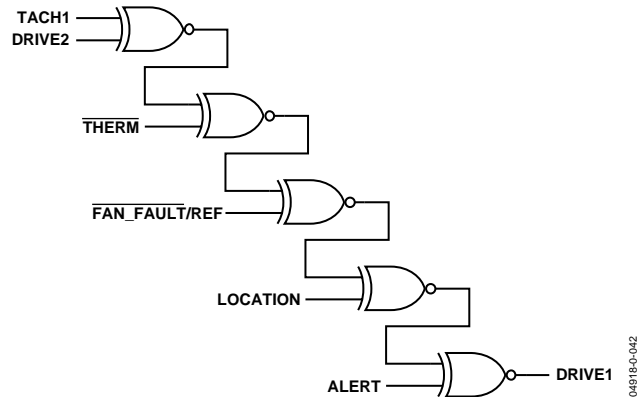

Figure 44. XOR Tree Test

LOCK BIT

Setting the Lock bit (Bit 6) of Configuration Register 1 (Address 0x01) makes all the lockable registers read-only. These registers remain read-only until the ADM1034 is powered down and back up again. For more information on which registers are lockable, see Table 34.

SW RESET

Setting the Software Reset bit (Bit 0) of Configuration Register 1 (Address 0x01) resets all software-resettable bits to their default value. For more information on resetting registers and their default values, see Table 34 to Table 74.

Table 34. ADM1034 Registers

Address	R/W	Description	Bit 7	Bit 6	Bit 5	Bit 4	Bit 3	Bit 2	Bit 1	Bit 0	Default	Lockable?
0x00/80	R/W	#Bytes/Block Read	7	6	5	4	3	2	1	0	0x20	Y
0x01/81	R/W	Configuration 1	Table/SW	Lock	SDA	SCL	ALERT	TIMER	Avg	Mon	0x01	Y
0x02/82	R/W	Configuration 2	R R	RES	CS	CS	LUT	D/L	BD	Reset	0x84	Y
0x03/83	R/W	Configuration 3	#FP2	#FP2	#FP2	#FP2	#FP1	#FP1	#FP1	#FP1	0x44	Y
0x04/84	R/W	Configuration 4	FF/ REF	%T	%T	%T	XOR	R2TM	R1TM	LTM	0x00	Y
0x05/85	R/W	Conversion Rate	RES	RES	RES	RES	Conv	Conv	Conv	Conv	0x07	Y
0x06/86	R/W	Fault Queue	RES	RES	RES	RES	FQ	FQ	FQ	FQ	0x01	Y
0x07/87	R/W	Fan Behavior	F2 Off	F1 Off	RES	RES	D2B	D2B	D1B	D1B	0x09	Y
0x08/88	R/W	Mask 1	LH	LL	R1H	R1L	R1D	R2H	R2L	R2D	0x52	N
0x09/89	R/W	Mask 2	RES	RES	RES	%T	TA	TS	RES	RES	0x10	N
0x0A/8A	R/W	Mask 3	F1S	FA	F2S	RES	RES	RES	RES	RES	0x00	N
0x0B/8B	R/W	Local High Limit	7	6	5	4	3	2	1	0	0x8B	N
0x0C/8C	R/W	Local Low Limit	7	6	5	4	3	2	1	0	0x54	N
0x0D/8D	R/W	Local THERM Limit	7	6	5	4	3	2	1	0	0x95	Y
0x0E/8E	R/W	Remote 1 High Limit	7	6	5	4	3	2	1	0	0x8B	N
0x0F/8F	R/W	Remote 1 Low Limit	7	6	5	4	3	2	1	0	0x54	N
0x10/90	R/W	Remote 1 THERM Limit	7	6	5	4	3	2	1	0	0x95	Y
0x11/91	R/W	Remote 2 High Limit	7	6	5	4	3	2	1	0	0x8B	N
0x12/92	R/W	Remote 2 Low Limit	7	6	5	4	3	2	1	0	0x54	N
0x13/93	R/W	Remote 2 THERM Limit	7	6	5	4	3	2	1	0	0x95	Y
0x16/96	R/W	Local Offset	7	6	5	4	3	2	1	0	0x00	Y
0x17/97	R/W	Remote 1 Offset	7	6	5	4	3	2	1	0	0x00	Y
0x18/98	R/W	Remote 2 Offset	7	6	5	4	3	2	1	0	0x00	Y
0x19/99	R/W	THERM % Limit	7	6	5	4	3	2	1	0	0xFF	Y
0x1A/9A	R/W	THERM Hysteresis	RES	RES	RES	RES	Hys	Hys	Hys	Hys	0x05	Y
0x22/A2	R/W	Look-Up Table T1	7	6	5	4	3	2	1	0	0xFF	Y
0x23/A3	R/W	Look-Up Table T2	7	6	5	4	3	2	1	0	0xFF	Y
0x24/A4	R/W	Look-Up Table T3	7	6	5	4	3	2	1	0	0xFF	Y
0x25/A5	R/W	Look-Up Table T4	7	6	5	4	3	2	1	0	0xFF	Y
0x26/A6	R/W	Look-Up Table T5	7	6	5	4	3	2	1	0	0xFF	Y
0x27/A7	R/W	Look-Up Table T6	7	6	5	4	3	2	1	0	0xFF	Y
0x28/A8	R/W	Look-Up Table T7	7	6	5	4	3	2	1	0	0xFF	Y
0x29/A9	R/W	Look-Up Table T8	7	6	5	4	3	2	1	0	0xFF	Y
0x2A/AA	R/W	Look-Up Table, FS1	7	6	5	4	3	2	1	0	0xFF	Y
0x2B/AB	R/W	Look-Up Table, FS1	15	14	13	12	11	10	9	8	0xFF	Y
0x2C/AC	R/W	Look-Up Table, FS2	7	6	5	4	3	2	1	0	0xFF	Y
0x2D/AD	R/W	Look-Up Table, FS2	15	14	13	12	11	10	9	8	0xFF	Y
0x2E/AE	R/W	Look-Up Table, FS3	7	6	5	4	3	2	1	0	0xFF	Y
0x2F/AF	R/W	Look-Up Table, FS3	15	14	13	12	11	10	9	8	0xFF	Y
0x30/B0	R/W	Look-Up Table, FS4	7	6	5	4	3	2	1	0	0xFF	Y
0x31/B1	R/W	Look-Up Table, FS4	15	14	13	12	11	10	9	8	0xFF	Y
0x32/B2	R/W	Look-Up Table, FS5	7	6	5	4	3	2	1	0	0xFF	Y
0x33/B3	R/W	Look-Up Table, FS5	15	14	13	12	11	10	9	8	0xFF	Y
0x34/B4	R/W	Look-Up Table, FS6	7	6	5	4	3	2	1	0	0xFF	Y
0x35/B5	R/W	Look-Up Table, FS6	15	14	13	12	11	10	9	8	0xFF	Y
0x36/B6	R/W	Look-Up Table, FS7	7	6	5	4	3	2	1	0	0xFF	Y
0x37/B7	R/W	Look-Up Table, FS7	15	14	13	12	11	10	9	8	0xFF	Y
0x38/B8	R/W	Look-Up Table, FS8	7	6	5	4	3	2	1	0	0xFF	Y
0x39/B9	R/W	Look-Up Table, FS8	15	14	13	12	11	10	9	8	0xFF	Y
0x3A/BA	R/W	Look-Up Table Hysteresis	RES	RES	RES	RES	Hys	Hys	Hys	Hys	0x05	Y
0x3C/BC	R/W	Fan Response	RES	F2	F2	F2	RES	F1	F1	F1	0x11	Y

ADM1034

Address	R/W	Description	Bit 7	Bit 6	Bit 5	Bit 4	Bit 3	Bit 2	Bit 1	Bit 0	Default	Lockable?
0x3D/BD	R	Device ID	7	6	5	4	3	2	1	0	0x34	N
0x3E/BE	R	Company ID	7	6	5	4	3	2	1	0	0x41	N
0x3F/BF	R	Revision Register	7	6	5	4	3	2	1	0	0x02	N
0x40/C0	R	Local Temperature	4	3	2	1	0	RES	RES	RES	0x00	N
0x41/C1	R	Local Temperature	12	11	10	9	8	7	6	5	0x00	N
0x42/C2	R	Remote 1 Temperature	4	3	2	1	0	RES	RES	RES	0x00	N
0x43/C3	R	Remote 1 Temperature	12	11	10	9	8	7	6	5	0x00	N
0x44/C4	R	Remote 2 Temperature	4	3	2	1	0	RES	RES	RES	0x00	N
0x45/C5	R	Remote 2 Temperature	12	11	10	9	8	7	6	5	0x00	N
0x4A/CA	R	TACH1 Period	7	6	5	4	3	2	1	0	0xFF	N
0x4B/CB	R	TACH1 Period	15	14	13	12	11	10	9	8	0xFF	N
0x4C/CC	R	TACH2 Period	7	6	5	4	3	2	1	0	0xFF	N
0x4D/CD	R	TACH2 Period	15	14	13	12	11	10	9	8	0xFF	N
0x4E/CE	R	THERM % Ontime	7	6	5	4	3	2	1	0	0x00	N
0x4F/CF	R	Status 1	LH	LL	R1H	R1L	R1D	R2H	R2L	R2D	0x00	N
0x50/D0	R	Status 2	LT	R1T	R2T	%T	TA	TS	RES	RES	0x00	N
0x51/D1	R	Status 3	F1S	FA	F2S	RES	RES	RES	RES	ALERT	0x00	N

Table 35. Register 0x00, # Bytes/Block Read, POR = 0x20, Lock = Y, S/W Reset = Y

Bit	Name	R/W	Description
<7:0>	# Bytes Block Read	R/W	Block reads are # bytes/block read long. The maximum is 32 bytes, the SMBus transaction limit.

Table 36. Register 0x01, Configuration Register 1, Power-On Default 0x01, Lock = Y, SW Reset = Y

Bit	Name	R/W	Description
7	Table/SW Con	R/W	Set this bit to 1 to place the fan speed under the control of the look-up table. When this bit is 0, the ADM1034 is in software/manual control mode. Default = 0.
6	Lock Bit	R/W	Set this bit to 1 to prevent the user from writing to the ADM1034 registers. 1 = ADM1034 registers locked. 0 = ADM1034 registers unlocked. Default = 0.
5	SDA Timeout	R/W	1 = SDA timeout enabled. 0 = SDA timeout disabled. Default = 0.
4	SCL Timeout	R/W	1 = SCL timeout enabled. 0 = SCL timeout disabled. Default = 0.
3	ALERT Configuration	R/W	0 = SMBusALERT. Default = 0. 1 = ALERT_COMP mode.
2	Enable THERM Timer	R/W	1 = timer enabled, 0 = timer disabled. This bit enables THERM as an input. Default = 0.
1	Averaging Off	R/W	This bit is used to disable averaging at the slower conversion rates (8 Hz and slower). Averaging is automatically disabled at the higher (16, 32, and 64 Hz) conversion rates. Default = averaging on = 0.
0	Monitor/STBY	R/W	Set bit to 1 to enable temperature monitoring. Set bit to 0 to disable it. Power-On Default = 1

Table 37. Register 0x02, Configuration Register 2, Power-On Default 0x84, Lock = Y, SW Reset = Y

Bit	Name	R/W	Description
7	Round Robin	R/W	This bit enables the round-robin mode. Set this bit to 0 to put the ADM1034 in single-channel mode. The ADC converts on one channel only, which is determined by the channel selector bits. Default = Round Robin = 1.
6	Reserved	R/W	Reserved.
<5:4>	Channel Selector	R/W	This bit determines the channel on which the ADC converts. 00 = Local Channel Only 01 = Remote 1 Channel Only 10 = Remote 2 Channel Only 11 = Reserved
3	4:8 Look-Up Table	R/W	This bit determines how many table points are used to control each fan. 0 = 4 table points for each fan 1 = all 8 points on one table; this table is used to control both fans
2	Discrete/Linear	R/W	This bit determines whether the fans run at discrete speeds or at speeds that increase with

Bit	Name	R/W	Description
1	Speed Boost Disable	R/W	temperature between the two thresholds. Default = 1 = Linear. Set bit to 1 to prevent the fans from being boosted if either $\overline{\text{THERM}}$ temperature or $\overline{\text{THERM}}$ timer limits are exceeded. Under these conditions, the fan runs at the previously calculated speed. Default = 0.
0	SW Reset	R/W	Set this bit to 1 to reset the ADM1034 registers to their default values, excluding the limit registers, offset registers, and look-up table registers. This bit self-clears. Default = 0.

Table 38. Register 0x03, Configuration Register 3, Power-On Default= 0x44, Lock = Y, SW Reset = Y

Bit	Name	R/W	Description
<7:4>	#Poles Fan 2	R/W	Write the number of poles on Fan 2 to this register. power-on default = 4 poles = 100. This should always be an even number, because there cannot be an odd number of poles in a fan.
<3:0>	#Poles Fan 1	R/W	Write the number of poles in Fan 1 to this register. power-on default = 4 poles = 100. This should always be an even number, because there cannot be an odd number of poles in a fan.

Table 39. Register 0x04, Configuration Register 4, Power-On Default = 0x00, Lock = Y, SW Reset = Y

Bit	Name	R/W	Description
7	FAN_FAULT/REF	R/W	This bit sets the function for Pin 8. 0 = Default = $\overline{\text{FAN_FAULT}}$ output ($\overline{\text{THERM}}$ input is CMOS). 1 = Reference input for $\overline{\text{THERM}}$.
<6:4>	$\overline{\text{THERM}}$ % Time Window	R/W	These bits set the time window over which $\overline{\text{THERM}}$ % is calculated. 000 = 0.25 second 001 = 0.5 second 010 = 1 second 011 = 2 seconds 100 = 4 seconds 101 = 8 seconds 110 = 8 seconds 111 = 8 seconds
3	XOR Test	R/W	Set this bit to 1 to enable the XOR connectivity test.
2	Enable Remote 2 $\overline{\text{THERM}}$ Events	R/W	This bit enables $\overline{\text{THERM}}$ assertions as an output. Functions when the $\overline{\text{THERM}}$ timer is enabled and the Remote 2 temperature exceeds its $\overline{\text{THERM}}$ limit.
1	Enable Remote 1 $\overline{\text{THERM}}$ Events	R/W	This bit enables $\overline{\text{THERM}}$ assertions as an output. Functions when the $\overline{\text{THERM}}$ timer is enabled and the Remote 1 temperature exceeds its $\overline{\text{THERM}}$ limit.
0	Enable Local $\overline{\text{THERM}}$ Events	R/W	This bit enables $\overline{\text{THERM}}$ assertions as an output. Functions when the $\overline{\text{THERM}}$ timer is enabled and the local temperature exceeds its $\overline{\text{THERM}}$ limit.

Table 40. Register 0x05, Conversion Rate Register, Power-On Default = 0x07, Lock = Y, SW Reset = Y

Bit	Name	R/W	Description
7	Res	R	This bit is reserved for future use. Do not write to this bit.
<6:4>	Res	R	Reserved.
<3:0>	Conversion Rate	R/W	These four bits set the conversion rate of the ADM1034. Changing these bits does not update the conversion rate until the start of the next round robin. 0000 = 0.0625 conversions/second 0001 = 0.125 conversions/second 0010 = 0.25 conversions/second 0011 = 0.5 conversions/second 0100 = 1 conversion/second 0101 = 2 conversions/second 0110 = 4 conversions/second 0111 = 8 conversions/second = default 1000 = 16 conversions/second 1001 = 32 conversions/second 1010 = 64 conversions/second

ADM1034

Table 41. Register 0x06, Fault Queue, Power-On Default = 0x01, Lock = Y, SW Reset = Y

Bit	Name	R/W	Description
<7:4>	Unused	R	Reserved.
<3:0>	Fault Queue Length	R/W	These four bits set the fault queue (the number of out-of-limit measurements made before an ALERT is generated). 000x = 1 001x = 2 01xx = 3 1xxx = 4

Table 42. Register 0x07, Fan Behavior Register, Power-On Default = 0x09, Lock = Y, SW Reset = Y

Bit	Name	R/W	Description
7	Fan2 Off	R/W	Set this bit to 1 to switch off Fan 2.
6	Fan1 Off	R	Set this bit to 1 to switch off Fan 1.
5	Res	R	Reserved.
4	Res	R	Reserved.
<3:2>	DRIVE2 BHVR	R/W	These bits determine which temperature source controls the DRIVE2 output. 00 = Local temperature controls DRIVE2. 01 = Remote 1 temperature controls DRIVE2. 10 = Remote 2 temperature controls DRIVE2. 11 = DRIVE2 full speed.
<1:0>	DRIVE1 BHVR	R/W	These bits determine which temperature source controls the DRIVE1 output. 00 = Local temperature controls DRIVE1. 01 = Remote 1 temperature controls DRIVE1. 10 = Remote 2 temperature controls DRIVE1. 11 = DRIVE1 full speed.

Table 43. Register 0x08, Mask Register 1, Power-On Default = 0x52, Lock = N, SW Reset = Y

Bit	Name	R/W	Description
7	Local High	R/W	A 1 disables the corresponding interrupt status bit from causing the interrupt output to be set. The status bit is not affected. Default = 0.
6	Local Low	R/W	A 1 disables the corresponding interrupt status bit from causing the interrupt output to be set. The status bit is not affected. Default = 1.
5	Remote 1 High	R/W	A 1 disables the corresponding interrupt status bit from causing the interrupt output to be set. The status bit is not affected. Default = 0.
4	Remote 1 Low	R/W	A 1 disables the corresponding interrupt status bit from causing the interrupt output to be set. The status bit is not affected. Default = 1.
3	Remote 1 Diode Error	R/W	A 1 disables the corresponding interrupt status bit from causing the interrupt output to be set. The status bit is not affected. Default = 0.
2	Remote 2 High	R/W	A 1 disables the corresponding interrupt status bit from causing the interrupt output to be set. The status bit is not affected. Default = 0.
1	Remote 2 Low	R/W	A 1 disables the corresponding interrupt status bit from causing the interrupt output to be set. The status bit is not affected. Default = 1.
0	Remote 2 Diode Error	R/W	A 1 disables the corresponding interrupt status bit from causing the interrupt output to be set. The status bit is not affected. Default = 0.

Table 44. Register 0x09, Mask Register 2, Power-On Default = 0x10, Lock = N, SW Reset = Y

Bit	Name	R/W	Description
<7:5>	Unused	R	Unused.
4	$\overline{\text{THERM}} \%$	R/W	A 1 disables the corresponding interrupt status bit, preventing it from causing the interrupt output. The status bit is not affected. Default = 0.
3	$\overline{\text{THERM}}$ Assert	R/W	A 1 disables the corresponding interrupt status bit, preventing it from causing the interrupt output. The status bit is not affected. Default = 0.
2	$\overline{\text{THERM}}_{\text{State}}$	R/W	A 1 disables the corresponding interrupt status bit, preventing it from causing the interrupt output. The status bit is not affected. Default = 0. This bit has no effect in $\overline{\text{ALERT}}$ comparator mode, because the corresponding status bit does not generate an $\overline{\text{ALERT}}$ in that mode.
<1:0>	Unused	R	Unused.

Table 45. Register 0x0A, Mask Register 3, Power-On Default = 0x00, Lock = N, SW Reset = Y

Bit	Name	R/W	Description
7	Fan 1 Stalled	R/W	A 1 disables the corresponding interrupt status bit, preventing it from causing the interrupt output. The status bit is not affected. Default = 0.
6	Fan Alarm Speed	R/W	A 1 disables the corresponding interrupt status bit, preventing it from causing the interrupt output. The status bit is not affected. Default = 0.
5	Fan 2 Stalled	R/W	A 1 disables the corresponding interrupt status bit, preventing it from causing the interrupt output. The status bit is not affected. Default = 0.
4	Reserved	R	Reserved. Default = 0.
3	Reserved	R	Reserved. Default = 0.
2	Reserved	R	Reserved. Default = 0.
1	Reserved	R	Reserved. Default = 0.
0	Reserved	R	Reserved. Default = 0.

Table 46. Register 0x0B, Local High Limit, Power-On Default = 0x8B, Lock = N, SW Reset = N

Bit	Name	R/W	Description
<7:0>	Local High Limit	R/W	When the local temperature exceeds this temperature, the corresponding interrupt status bit is set.

Table 47. Register 0x0C, Local Low Limit, Power-On Default = 0x54, Lock = N, SW Reset = N

Bit	Name	R/W	Description
<7:0>	Local Low Limit	R/W	When the local temperature falls below this temperature, the corresponding interrupt status bit is set.

Table 48. Register 0x0D, Local $\overline{\text{THERM}}$ Limit, Power-On Default = 0x95, Lock = Y, SW Reset = N

Bit	Name	R/W	Description
<7:0>	Local $\overline{\text{THERM}}$ Limit	R/W	When the local temperature exceeds this temperature, the corresponding status bit is set and the $\overline{\text{THERM}}$ output is activated.

Table 49. Register 0x0E, Remote 1 High Limit, Power-On Default = 0x8B, Lock = N, SW Reset = N

Bit	Name	R/W	Description
<7:0>	Remote 1 High Limit	R/W	When the Remote 1 temperature exceeds this temperature, the corresponding interrupt status bit is set.

Table 50. Register 0x0F, Remote 1 Low Limit, Power-On Default = 0x54, Lock = N, SW Reset = N

Bit	Name	R/W	Description
<7:0>	Remote 1 Low Limit	R/W	When the Remote 1 temperature falls below this temperature, the corresponding interrupt status bit is set.

ADM1034

Table 51. Register 0x10, Remote 1 $\overline{\text{THERM}}$ Limit, Power-On Default = 0x95, Lock = Y, SW Reset = N

Bit	Name	R/W	Description
<7:0>	Remote 1 $\overline{\text{THERM}}$ Limit	R/W	When the Remote 1 temperature exceeds this temperature, the corresponding status bit is set and the $\overline{\text{THERM}}$ output is activated.

Table 52. Register 0x11, Remote 2 High Limit, Power-On Default = 0x8B, Lock = N, SW Reset = N

Bit	Name	R/W	Description
<7:0>	Remote 2 High Limit	R/W	When the Remote 2 temperature exceeds this temperature, the corresponding interrupt status bit is set.

Table 53. Register 0x12, Remote 2 Low Limit, Power-On Default = 0x54, Lock = N, SW Reset = N

Bit	Name	R/W	Description
<7:0>	Remote 2 Low Limit	R/W	When the Remote 2 temperature falls below this temperature, the corresponding interrupt status bit is set.

Table 54. Register 0x13, Remote 2 $\overline{\text{THERM}}$ Limit, Power-On Default = 0x95, Lock = Y, SW Reset = N

Bit	Name	R/W	Description
<7:0>	Remote 2 $\overline{\text{THERM}}$ Limit	R/W	When the Remote 2 temperature exceeds this temperature, the corresponding status bit is set and the $\overline{\text{THERM}}$ output is activated.

Table 55. Register 0x16, Local Offset Register, Power-On Default = 0x00, Lock = Y, SW Reset = N

Bit	Name	R/W	Description
<7:0>	Local Offset	R/W	Allows a twos complement offset to be automatically added to or subtracted from the local temperature measurement. Resolution = 0.125°C. Maximum offset from –16°C to +15.875°C. Default = 0.

Table 56. Register 0x17, Remote 1 Offset Register, Power-On Default = 0x00, Lock = Y, SW Reset = N

Bit	Name	R/W	Description
<7:0>	Remote 1 Offset	R/W	Allows a twos complement offset to be automatically added to or subtracted from the Remote 1 temperature measurement. Resolution = 0.125°C. Maximum offset from –16°C to +15.875°C. Default = 0.

Table 57. Register 0x18, Remote 2 Offset Register, Power-On Default = 0x00, Lock = Y, SW Reset = N

Bit	Name	R/W	Description
<7:0>	Remote 2 Offset	R/W	Allows a twos complement offset to be automatically added to or subtracted from the Remote 2 temperature measurement. Resolution = 0.125°C. Maximum offset from –16°C to +15.875°C. Default = 0.

Table 58. Register 0x19, $\overline{\text{THERM}}$ Timer % Limit, Power-On Default = 0xFF, Lock = Y, SW Reset = N

Bit	Name	R/W	Description
<7:0>	$\overline{\text{THERM}}$ Timer on% Limit	R/W	If the $\overline{\text{THERM}}$ is asserted for greater than this limit on the time window, the corresponding status bit is set.

Table 59. Register 0x1A, $\overline{\text{THERM}}$ Hysteresis, Power-On Default = 0x05, Lock = Y, SW Reset = N

Bit	Name	R/W	Description
<7:4>	Reserved	R	Reserved.
<3:0>	$\overline{\text{THERM}}$ Hysteresis	R/W	An unsigned $\overline{\text{THERM}}$ hysteresis value, LSB = 1°C. Once $\overline{\text{THERM}}$ has been activated on a temperature channel, the $\overline{\text{THERM}}$ limit – hysteresis is deactivated if the temperature drops below $\overline{\text{THERM}}$.

Table 60. Look-Up Table Registers, Lock = Y, SW Reset = Y

Register Address	R/W	Description	Power-On Default
0x22	R/W	Look-Up Table, T1	0xFF
0x23	R/W	Look-Up Table, T2	0xFF
0x24	R/W	Look-Up Table, T3	0xFF
0x25	R/W	Look-Up Table, T4	0xFF
0x26	R/W	Look-Up Table, T5	0xFF
0x27	R/W	Look-Up Table, T6	0xFF
0x28	R/W	Look-Up Table, T7	0xFF
0x29	R/W	Look-Up Table, T8	0xFF
0x2A	R/W	Look-Up Table, FS1, LSB	0xFF
0x2B	R/W	Look-Up Table, FS1, MSB	0xFF
0x2C	R/W	Look-Up Table, FS2, LSB	0xFF
0x2D	R/W	Look-Up Table, FS2, MSB	0xFF
0x2E	R/W	Look-Up Table, FS3, LSB	0xFF
0x2F	R/W	Look-Up Table, FS3, MSB	0xFF
0x30	R/W	Look-Up Table, FS4, LSB	0xFF
0x31	R/W	Look-Up Table, FS4, MSB	0xFF
0x32	R/W	Look-Up Table, FS5, LSB	0xFF
0x33	R/W	Look-Up Table, FS5, MSB	0xFF
0x34	R/W	Look-Up Table, FS6, LSB	0xFF
0x35	R/W	Look-Up Table, FS6, MSB	0xFF
0x36	R/W	Look-Up Table, FS7, LSB	0xFF
0x37	R/W	Look-Up Table, FS7, MSB	0xFF
0x38	R/W	Look-Up Table, FS8, LSB	0xFF
0x39	R/W	Look-Up Table, FS8, MSB	0xFF

Table 61. Register 0x3A, Look-Up Table Hysteresis, Power-On Default = 0x05 Lock = Y, SW Reset = Y

Bit	Name	R/W	Description
<7:4>	Reserved	R	Reserved.
<3:0>	Look-up Table Hysteresis	R/W	These bits determine the hysteresis applied to the temperature thresholds in the look-up table. LSB size = 1°C.

Table 62. Register 0x3C, Fan Response Register, Power-On Default = 0x11, Lock = Y, SW Reset = Y

Bit	Name	R/W	Description
7	Res	R	Reserved.
<6:4>	Fan 2 Response	R/W	These bits set the fan's response in the fan speed control mode. 000 = 1.25 updates/second 001 = 2.5 updates/second = Default 010 = 5 updates/second 011 = 10 updates/second 100 = 20 updates/second 101 = 40 updates/second 110 = 80 updates/second 111 = 160 updates/second
3	Res	R	Reserved.
<2:0>	Fan 1 Response	R/W	These bits set the fan's response in the fan speed control mode. 000 = 1.25 updates/second 001 = 2.5 updates/second = Default 010 = 5 updates/second 011 = 10 updates/second 100 = 20 updates/second 101 = 40 updates/second 110 = 80 updates/second 111 = 160 updates/second

ADM1034

Table 63. Register 0x3D, Device ID, Power-On Default = 0x34, Lock = N, SW Reset = N

Bit	Name	R/W	Description
<7:0>	Device ID	R	This read-only value contains the device ID, which is 0x34.

Table 64. Register 0x3E, Company ID, Power-On Default = 0x41, Lock = N, SW Reset = N

Bit	Name	R/W	Description
<7:0>	Company ID	R	This read-only value contains the company ID, which is 0x41.

Table 65. Register 0x3F, Revision Register, Power-On Default = 0x02, Lock = N, SW Reset = N

Bit	Name	R/W	Description
<7:0>	Revision ID	R	This read-only value contains the revision ID.

Table 66. Register 0x40/41, Local Temp Registers, Power-On Default = 0x00, Lock = N, SW Reset = Y

Bit	Name	R/W	Description
<4:0>	Local Temperature LSB	R	This register contains the LSBs of the last measured local temperature value. Resolution = 0.03125°C.
<12:5>	Local Temperature MSB	R	This register contains the MSBs of the last measured local temperature value. Resolution = 1°C.

Table 67. Register 0x42/43, Remote 1 Temp Registers, Power-On Default = 0x00, Lock = N, SW Reset = Y

Bit	Name	R/W	Description
<4:0>	Remote 1 Temperature LSB	R	This register contains the LSBs of the last measured Remote 1 temperature value. Resolution = 0.03125°C.
<12:5>	Remote 1 Temperature MSB	R	This register contains the MSBs of the last measured Remote 1 temperature value. Resolution = 1°C.

Table 68. Register 0x44/45, Remote 2 Temp Registers, Power-On Default = 0x00, Lock = N, SW Reset = Y

Bit	Name	R/W	Description
<4:0>	Remote 2 Temperature LSB	R	This register contains the LSBs of the last measured Remote 2 temperature value. Resolution = 0.03125°C.
<12:5>	Remote 2 Temperature MSB	R	This register contains the MSBs of the last measured Remote 2 temperature value. Resolution = 1°C.

Table 69. Register 0x4A/4B, TACH1 Period, Power-On Default = 0x00, Lock = N, SW Reset = Y

Bit	Name	R/W	Description
<7:0>	Fan 1 Period Count, LSB	R	This register contains the LSBs of the last measured Fan 1 revolution count.
<15:8>	Fan 1 Period Count, MSB	R	This register contains the MSBs of the last measured Fan 1 revolution count.

Table 70. Register 0x4C/4D, TACH2 Period, Power-On Default = 0x00, Lock = N, SW Reset = Y

Bit	Name	R/W	Description
<7:0>	Fan 2 Period Count, LSB	R	This register contains the LSBs of the last measured Fan 2 revolution count.
<15:8>	Fan 2 Period Count, MSB	R	This register contains the MSBs of the last measured Fan 2 revolution count.

Table 71. Register 0x4E, THERM % On-Time, Power-On Default = 0x00, Lock = N, SW Reset = Y

Bit	Name	R/W	Description
<7:0>	THERM % On-Time	R	Represents the % time of THERM activity within the time window set by the configuration bits.

Table 72. Register 0x4F, Status 1, Power-On Default = 0x00, Lock = N, SW Reset = Y

Bit	Name	R/W	Description
7	Local Temp High	R	A 1 indicates that the local high limit has been tripped.
6	Local Temp Low	R	A 1 indicates that the local low limit has been tripped.
5	Remote 1 Temp High	R	A 1 indicates that the Remote 1 high limit has been tripped.
4	Remote 1 Temp Low	R	A 1 indicates that the Remote 1 low limit has been tripped.
3	Remote 1 Diode Error	R	A 1 indicates that a short or an open has been detected on the Remote 1 temperature channel. This test is completed once on each conversion.
2	Remote 2 Temp High	R	A 1 indicates that the Remote 2 high limit has been tripped.
1	Remote 2 Temp Low	R	A 1 indicates that the Remote 2 low limit has been tripped.
0	Remote 2 Diode Error	R	A 1 indicates that a short or an open has been detected on the Remote 2 temperature channel. This test is completed once on each conversion.

Table 73. Register 0x50, Status 2, Power-On Default = 0x00, Lock = N, SW Reset = Y

Bit	Name	R/W	Description
7	Local $\overline{\text{THERM}}$	R	A 1 indicates that the local $\overline{\text{THERM}}$ limit has been tripped.
6	Remote 1 $\overline{\text{THERM}}$	R	A 1 indicates that the Remote 1 $\overline{\text{THERM}}$ limit has been tripped.
5	Remote 2 $\overline{\text{THERM}}$	R	A 1 indicates that the Remote 2 $\overline{\text{THERM}}$ limit has been tripped.
4	$\overline{\text{THERM}}$ % Exceeded	R	A 1 indicates that the $\overline{\text{THERM}}$ signal has been asserted for longer than the programmed limit. Clear on Read. If $\overline{\text{THERM}}$ % Limit = 0x00 and $\overline{\text{THERM}}$ is asserted, it is reasserted immediately.
3	$\overline{\text{THERM}}$ Asserted	R	A 1 indicates that the $\overline{\text{THERM}}$ signal has been asserted low as an input only.
2	$\overline{\text{THERM}}$ _State	R	A 1 indicates that the $\overline{\text{THERM}}$ pin has been asserted low as an output.
1	Reserved	R	Reserved.
0	Reserved	R	Reserved.

Table 74. Register 0x51, Status Register 3, Power-On Default = 0x00, Lock = N, SW Reset = Y

Bit	Name	R/W	Description
7	Fan 1 Stalled	R	A 1 indicates that Fan 1 has stalled.
6	Fan Alarm Speed	R	A 1 indicates that the fans are running at full speed due to an alarm condition, for instance, when a $\overline{\text{THERM}}$ temperature limit is exceeded.
5	Fan 2 Stalled	R	A 1 indicates that Fan 2 has stalled.
4	Reserved	R	Reserved.
3	Reserved	R	Reserved.
2	Reserved	R	Reserved.
1	Reserved	R	Reserved.
0	$\overline{\text{ALERT}}$ Low	R	A 1 indicates that the ADM1034 has pulled the $\overline{\text{ALERT}}$ output pin low. This allows polling of a single status register to determine if an $\overline{\text{ALERT}}$ condition in any of the status registers has occurred.

ADM1034

OUTLINE DIMENSIONS

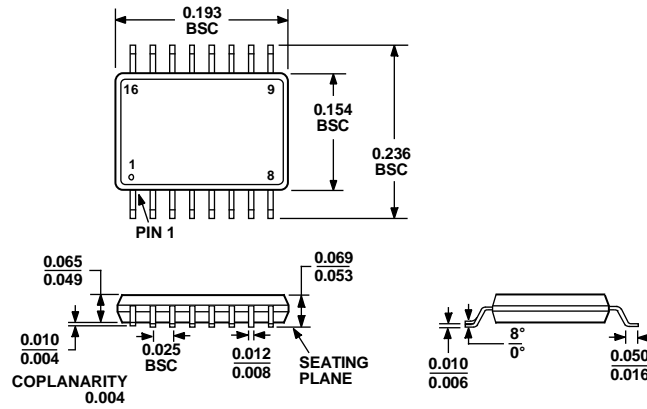

COMPLIANT TO JEDEC STANDARDS MO-137AB

Figure 45. 16-Lead Shrink Small Outline Package [QSOP]
(RQ-16)
Dimensions shown in inches

ORDERING GUIDE

Model	Temperature Range	Package Description	Package Option
ADM1034ARQ	-40°C to +125°C	16-Lead QSOP	RQ-16
ADM1034ARQ-REEL	-40°C to +125°C	16-Lead QSOP	RQ-16
ADM1034ARQ-REEL7	-40°C to +125°C	16-Lead QSOP	RQ-16
ADM1034ARQZ ¹	-40°C to +125°C	16-Lead QSOP	RQ-16
ADM1034ARQZ-REEL ¹	-40°C to +125°C	16-Lead QSOP	RQ-16
ADM1034ARQZ-REEL7 ¹	-40°C to +125°C	16-Lead QSOP	RQ-16

¹ Z = Pb-free part.