



8-Channel, 24-Bit ANALOG-TO-DIGITAL CONVERTER

FEATURES

- 24 BITS NO MISSING CODES
- 0.0015% INL
- 22 BITS EFFECTIVE RESOLUTION (PGA = 1), 19 BITS (PGA = 128)
- PGA FROM 1 TO 128
- SINGLE CYCLE SETTling MODE
- PROGRAMMABLE DATA OUTPUT RATES UP TO 1kHz
- ON-CHIP 1.25V/2.5V REFERENCE
- EXTERNAL DIFFERENTIAL REFERENCE OF 0.1V TO 2.5V
- ON-CHIP CALIBRATION
- SPI™ COMPATIBLE
- 2.7V TO 5.25V
- < 1mW POWER CONSUMPTION

APPLICATIONS

- INDUSTRIAL PROCESS CONTROL
- LIQUID/GAS CHROMATOGRAPHY
- BLOOD ANALYSIS
- SMART TRANSMITTERS
- PORTABLE INSTRUMENTATION
- WEIGHT SCALES
- PRESSURE TRANSDUCERS

SPI is a registered trademark of Motorola.

DESCRIPTION

The ADS1216 is a precision, wide dynamic range, delta-sigma, Analog-to-Digital (A/D) converter with 24-bit resolution operating from 2.7V to 5.25V supplies. The delta-sigma, A/D converter provides up to 24 bits of no missing code performance and effective resolution of 22 bits.

The eight input channels are multiplexed. Internal buffering can be selected to provide a very high input impedance for direct connection to transducers or low-level voltage signals. Burn out current sources are provided that allow for the detection of an open or shorted sensor. An 8-bit Digital-to-Analog (D/A) converter provides an offset correction with a range of 50% of the FSR (Full-Scale Range).

The PGA (Programmable Gain Amplifier) provides selectable gains of 1 to 128 with an effective resolution of 19 bits at a gain of 128. The A/D conversion is accomplished with a second-order delta-sigma modulator and programmable sinc filter. The reference input is differential and can be used for ratiometric cancellation. The on-board current DACs (Digital-to-Analog Converters) operate independently with the maximum current set by an external resistor.

The serial interface is SPI compatible. Eight bits of digital I/O are also provided that can be used for input or output. The ADS1216 is designed for high-resolution measurement applications in smart transmitters, industrial process control, weight scales, chromatography, and portable instrumentation.

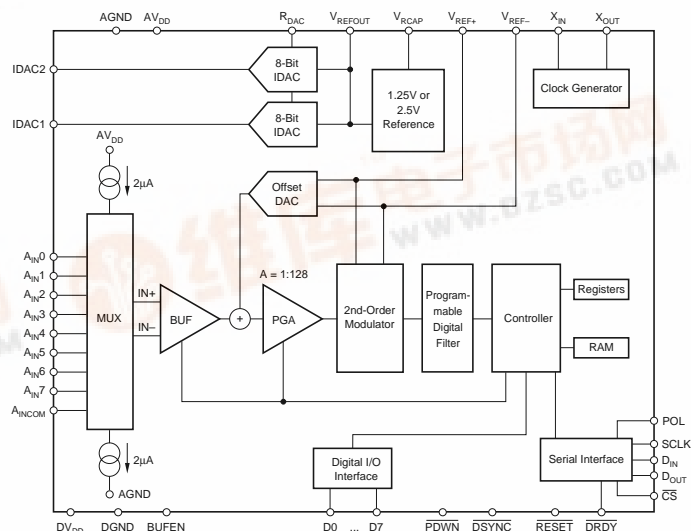

Please be aware that an important notice concerning availability, standard warranty, and use in critical applications of Texas Instruments semiconductor products and disclaimers thereto appears at the end of this data sheet.

ABSOLUTE MAXIMUM RATINGS⁽¹⁾

| | |
|--|--------------------------------------|
| AV _{DD} to AGND | -0.3V to +6V |
| DV _{DD} to DGND | -0.3V to +6V |
| Input Current | 100mA, Momentary |
| Input Current | 10mA, Continuous |
| A _{IN} | GND -0.5V to AV _{DD} + 0.5V |
| AV _{DD} to DV _{DD} | -6V to +6V |
| AGND to DGND | -0.3V to +0.3V |
| Digital Input Voltage to GND | -0.3V to DV _{DD} + 0.3V |
| Digital Output Voltage to GND | -0.3V to DV _{DD} + 0.3V |
| Maximum Junction Temperature | +150°C |
| Operating Temperature Range | -40°C to +85°C |
| Storage Temperature Range | -60°C to +100°C |
| Lead Temperature (soldering, 10s) | +300°C |

NOTE: (1) Stresses above those listed under "Absolute Maximum Ratings" may cause permanent damage to the device. Exposure to absolute maximum conditions for extended periods may affect device reliability.



ELECTROSTATIC DISCHARGE SENSITIVITY

This integrated circuit can be damaged by ESD. Texas Instruments recommends that all integrated circuits be handled with appropriate precautions. Failure to observe proper handling and installation procedures can cause damage.

ESD damage can range from subtle performance degradation to complete device failure. Precision integrated circuits may be more susceptible to damage because very small parametric changes could cause the device not to meet its published specifications.

PACKAGE/ORDERING INFORMATION

| PRODUCT | PACKAGE | PACKAGE DRAWING NUMBER | SPECIFIED TEMPERATURE RANGE | PACKAGE MARKING | ORDERING NUMBER ⁽¹⁾ | TRANSPORT MEDIA |
|----------|---------|------------------------|-----------------------------|-----------------|--------------------------------|-----------------|
| ADS1216Y | TQFP-48 | PFB | -40 to +85 | ADS1216Y | ADS1216Y/250 | Tape and Reel |
| " | " | " | " | " | ADS1216Y/2K | Tape and Reel |

NOTE: (1) Models with a slash (/) are available only in Tape and Reel in the quantities indicated (e.g., /2K indicates 2000 devices per reel). Ordering 2000 pieces of "ADS1216Y/2K" will get a single 2000-piece Tape and Reel.

ELECTRICAL CHARACTERISTICS: AV_{DD} = 5V

All specifications T_{MIN} to T_{MAX}, AV_{DD} = +5V, DV_{DD} = +2.7V to 5.25V, f_{MOD} = 19.2kHz, PGA = 1, Buffer ON, R_{DAC} = 150kΩ, f_{DATA} = 10Hz, V_{REF} = (REF IN+) - (REF IN-) = +2.5V, unless otherwise specified.

| PARAMETER | CONDITIONS | ADS1216 | | | UNITS |
|--|--|---------------------------|------------------------------|--|--------------|
| | | MIN | TYP | MAX | |
| ANALOG INPUT (A_{IN0} - A_{IN7}, A_{INCOM}) | | | | | |
| Analog Input Range | Buffer OFF Buffer ON | AGND - 0.1 AGND + 0.05 | | AV _{DD} + 0.1 AV _{DD} - 1.5 | V V |
| Full-Scale Input Voltage Range | (In+) - (In-), See Block Diagram | | | ±V _{REF} /PGA | V |
| Differential Input Impedance | Buffer OFF | | 5/PGA | | MΩ |
| Input Current | Buffer ON | | 0.5 | | nA |
| Bandwidth | | | | | |
| Fast Settling Filter | -3dB | | 0.469 • f _{DATA} | | Hz |
| Sinc ² Filter | -3dB | | 0.318 • f _{DATA} | | Hz |
| Sinc ³ Filter | -3dB | | 0.262 • f _{DATA} | | Hz |
| Programmable Gain Amplifier | User Selectable Gain Ranges | 1 | | 128 | |
| Input Capacitance | | | 9 | | pF |
| Input Leakage Current | Modulator OFF, T = 25°C | | 5 | | pA |
| Burnout Current Sources | | | 2 | | μA |
| OFFSET DAC | | | | | |
| Offset DAC Range | | 8 | ±V _{REF} /(2 • PGA) | | V |
| Offset DAC Monotonicity | | | ±10 | | Bits |
| Offset DAC Gain Error | | | 1 | | % |
| Offset DAC Gain Error Drift | | | | | ppm/°C |
| SYSTEM PERFORMANCE | | | | | |
| Resolution | | 24 | | 24 | Bits |
| No Missing Codes | sinc ³ Filter | | | | Bits |
| Integral Non-Linearity | End Point Fit | | | ±0.0015 | % of FS |
| Offset Error ⁽¹⁾ | | | 7.5 | | ppm of FS |
| Offset Drift ⁽¹⁾ | | | 0.02 | | ppm of FS/°C |
| Gain Error ⁽¹⁾ | | | 0.005 | | % |
| Gain Error Drift ⁽¹⁾ | | | 0.5 | | ppm/°C |
| Common-Mode Rejection | at DC | 100 | | | dB |
| | f _{CM} = 60Hz, f _{DATA} = 10Hz | | 130 | | dB |
| | f _{CM} = 50Hz, f _{DATA} = 50Hz | | 120 | | dB |
| | f _{CM} = 60Hz, f _{DATA} = 60Hz | | 120 | | dB |
| Normal-Mode Rejection | f _{SIG} = 50Hz, f _{DATA} = 50Hz | | 100 | | dB |
| | f _{SIG} = 60Hz, f _{DATA} = 60Hz | | 100 | | dB |
| Output Noise | | | See Typical Characteristics | | |
| Power-Supply Rejection | at DC, dB = -20 log(ΔV _{OUT} /ΔV _{DD}) ⁽²⁾ | 80 | 95 | | dB |

ELECTRICAL CHARACTERISTICS: AV_{DD} = 5V (Cont.)

All specifications T_{MIN} to T_{MAX}, AV_{DD} = +5V, DV_{DD} = +2.7V to 5.25V, f_{MOD} = 19.2kHz, PGA = 1, Buffer ON, R_{DAC} = 150kΩ, f_{DATA} = 10Hz, V_{REF} ≡ (REF IN+) – (REF IN-) = +2.5V, unless otherwise specified.

| PARAMETER | CONDITIONS | ADS1216 | | | UNITS |
|---|---|---------|-------------------------------|----------------------|----------------------------|
| | | MIN | TYP | MAX | |
| VOLTAGE REFERENCE INPUT | | | | | |
| Reference Input Range | REF IN+, REF IN- V _{REF} ≡ (REF IN+) – (REF IN-) | AGND | | AV _{DD} | V |
| V _{REF} | | 0.1 | 2.5 | 2.6 | V |
| Common-Mode Rejection at DC | | | 120 | | dB |
| Common-Mode Rejection | f _{VREFCM} = 60Hz, f _{DATA} = 60Hz | | 120 | | dB |
| Bias Current ⁽³⁾ | V _{REF} = 2.5V | | 1.3 | | μA |
| ON-CHIP VOLTAGE REFERENCE | | | | | |
| Output Voltage | REF HI = 1 REF HI = 0 | 2.4 | 2.50 1.25 | 2.6 | V V |
| Short-Circuit Current Source | | | 8 | | mA |
| Short-Circuit Current Sink | | | 50 | | μA |
| Short-Circuit Duration | Sink or Source | | Indefinite | | |
| Drift | | | 15 | | ppm/°C |
| Noise | V _{RCAP} = 0.1μF, BW = 0.1Hz to 100Hz | | 10 | | μVp-p |
| Output Impedance | Sourcing 100μA | | 3 | | Ω |
| Startup Time | | | 50 | | μs |
| IDAC | | | | | |
| Full-Scale Output Current | R _{DAC} = 150kΩ, Range = 1 R _{DAC} = 150kΩ, Range = 2 R _{DAC} = 150kΩ, Range = 3 R _{DAC} = 15kΩ, Range = 3 | | 0.5 1 2 20 | | mA mA mA mA |
| Maximum Short-Circuit Current Duration | R _{DAC} = 10kΩ R _{DAC} = 0Ω R _{DAC} = 150kΩ | | Indefinite | 10 | Minute |
| Monotonicity | | 8 | | | Bits |
| Compliance Voltage | | 0 | | AV _{DD} – 1 | V |
| Output Impedance | | | See Typical Characteristics | | |
| PSRR | V _{OUT} = AV _{DD} /2 | | 400 | | ppm/V |
| Absolute Error | Individual IDAC | | 5 | | % |
| Absolute Drift | Individual IDAC | | 75 | | ppm/°C |
| Mismatch Error | Between IDACs, Same Range and Code | | 0.25 | | % |
| Mismatch Drift | Between IDACs, Same Range and Code | | 15 | | ppm/°C |
| POWER-SUPPLY REQUIREMENTS | | | | | |
| Power-Supply Voltage | AV _{DD} | 4.75 | | 5.25 | V |
| Analog Current (I _{ADC} + I _{VREF} + I _{DAC}) | PDWN = 0, or SLEEP PGA = 1, Buffer OFF PGA = 128, Buffer OFF PGA = 1, Buffer ON PGA = 128, Buffer ON | | 1 140 430 180 800 | | nA μA μA μA μA |
| V _{REF} Current (I _{VREF}) | | | 250 | 375 | μA |
| I _{DAC} Current (I _{DAC}) | Excludes Load Current | | 480 | 675 | μA |
| Digital Current | Normal Mode, DV _{DD} = 5V SLEEP Mode, DV _{DD} = 5V Read Data Continuous Mode, DV _{DD} = 5V PDWN | | 180 150 230 1 | 275 | μA μA μA nA |
| Power Dissipation | PGA = 1, Buffer OFF, REFEN = 0, I _{DACS} OFF, DV _{DD} = 5V | | 1.6 | 2.5 | mW |
| TEMPERATURE RANGE | | | | | |
| Operating | | -40 | | +85 | °C |
| Storage | | -60 | | +100 | °C |

NOTES: (1) Calibration can minimize these errors. (2) Δ V_{OUT} is change in digital result. (3) 12pF switched capacitor at f_{SAMP} clock frequency.

ELECTRICAL CHARACTERISTICS: $AV_{DD} = 3V$

All specifications T_{MIN} to T_{MAX} , $AV_{DD} = +3V$, $DV_{DD} = +2.7V$ to $5.25V$, $f_{MOD} = 19.2kHz$, $PGA = 1$, Buffer ON, $R_{DAC} = 75k\Omega$, $f_{DATA} = 10Hz$, $V_{REF} \equiv (REF\ IN+) - (REF\ IN-) = +1.25V$ unless otherwise specified.

| PARAMETER | CONDITIONS | ADS1216 | | | UNITS |
|---|--|---------------------------|-----------------------------|---|--------------|
| | | MIN | TYP | MAX | |
| ANALOG INPUT ($A_{IN0} - A_{IN7}, A_{INCOM}$) Analog Input Range | Buffer OFF Buffer ON | AGND – 0.1 AGND + 0.05 | | $AV_{DD} + 0.1$ $AV_{DD} - 1.5$ $\pm V_{REF}/PGA$ | V V V |
| Full-Scale Input Voltage Range | (In+) – (In–) See Block Diagram | | 5/PGA | | M Ω |
| Input Impedance | Buffer OFF | | 0.5 | | nA |
| Input Current | Buffer ON | | | | |
| Bandwidth | | | | | |
| Fast Settling Filter | –3dB | | $0.469 \cdot f_{DATA}$ | | Hz |
| Sinc ² Filter | –3dB | | $0.318 \cdot f_{DATA}$ | | Hz |
| Sinc ³ Filter | –3dB | | $0.262 \cdot f_{DATA}$ | | Hz |
| Programmable Gain Amplifier | User Selectable Gain Ranges | 1 | | 128 | |
| Input Capacitance | | | 9 | | pF |
| Input Leakage Current | Modulator OFF, T = 25°C | | 5 | | pA |
| Burnout Current Sources | | | 2 | | μ A |
| OFFSET DAC | | | | | |
| Offset DAC Range | | 8 | $\pm V_{REF}/(2 \cdot PGA)$ | | V |
| Offset DAC Monotonicity | | | ± 10 | | Bits |
| Offset DAC Gain Error | | | 2 | | % |
| Offset DAC Gain Error Drift | | | | | ppm/°C |
| SYSTEM PERFORMANCE | | | | | |
| Resolution | | 24 | | 24 | Bits |
| No Missing Codes | sinc ³ Filter | | | ± 0.0015 | Bits |
| Integral Non-Linearity | End Point Fit | | | | % of FS |
| Offset Error ⁽¹⁾ | | | 15 | | ppm of FS |
| Offset Drift ⁽¹⁾ | | | 0.04 | | ppm of FS/°C |
| Gain Error ⁽¹⁾ | | | 0.010 | | % |
| Gain Error Drift ⁽¹⁾ | | | 1.0 | | ppm/°C |
| Common-Mode Rejection | at DC | 100 | | | dB |
| | $f_{CM} = 60Hz, f_{DATA} = 10Hz$ | | 130 | | dB |
| | $f_{CM} = 50Hz, f_{DATA} = 50Hz$ | | 120 | | dB |
| | $f_{CM} = 60Hz, f_{DATA} = 60Hz$ | | 120 | | dB |
| Normal-Mode Rejection | $f_{SIG} = 50Hz, f_{DATA} = 50Hz$ | | 100 | | dB |
| | $f_{SIG} = 60Hz, f_{DATA} = 60Hz$ | | 100 | | dB |
| Output Noise | | | See Typical Characteristics | | |
| Power-Supply Rejection | at DC, dB = $-20 \log(\Delta V_{OUT}/\Delta V_{DD})^{(2)}$ | 75 | 90 | | dB |
| VOLTAGE REFERENCE INPUT | | | | | |
| Reference Input Range | REF IN+, REF IN– | 0 | | AV_{DD} | V |
| V_{REF} | $V_{REF} \equiv (REF\ IN+) - (REF\ IN-)$ | 0.1 | 1.25 | 1.3 | V |
| Common-Mode Rejection | at DC | | 120 | | dB |
| Common-Mode Rejection | $f_{VREFCM} = 60Hz, f_{DATA} = 60Hz$ | | 120 | | dB |
| Bias Current ⁽³⁾ | $V_{REF} = 1.25V$ | | 0.65 | | μ A |
| ON-CHIP VOLTAGE REFERENCE | | | | | |
| Output Voltage | REF HI = 0 | 1.2 | 1.25 | 1.3 | V |
| Short-Circuit Current Source | | | 3 | | mA |
| Short-Circuit Current Sink | | | 50 | | μ A |
| Short-Circuit Duration | Sink or Source | | Indefinite | | |
| Drift | | | 15 | | ppm/°C |
| Noise | $V_{RCAP} = 0.1\mu F, BW = 0.1Hz$ to 100Hz | | 10 | | $\mu Vp-p$ |
| Output Impedance | Sourcing 100 μ A | | 3 | | Ω |
| Startup Time | | | 50 | | μs |
| IDAC | | | | | |
| Full-Scale Output Current | $R_{DAC} = 75k\Omega, Range = 1$ | | 0.5 | | mA |
| | $R_{DAC} = 75k\Omega, Range = 2$ | | 1 | | mA |
| | $R_{DAC} = 75k\Omega, Range = 3$ | | 2 | | mA |
| | $R_{DAC} = 15k\Omega, Range = 3$ | | 20 | | mA |
| Maximum Short-Circuit Current Duration | $R_{DAC} = 10k\Omega$ | | Indefinite | | |
| | $R_{DAC} = 0\Omega$ | | | 10 | Minute |
| Monotonicity | $R_{DAC} = 75k\Omega$ | 8 | | | Bits |
| Compliance Voltage | | 0 | | $AV_{DD} - 1$ | V |
| Output Impedance | | | See Typical Characteristics | | |
| PSRR | $V_{OUT} = AV_{DD}/2$ | | 600 | | ppm/V |
| Absolute Error | Individual IDAC | | 5 | | % |
| Absolute Drift | Individual IDAC | | 75 | | ppm/°C |
| Mismatch Error | Between IDACs, Same Range and Code | | 0.25 | | % |
| Mismatch Drift | Between IDACs, Same Range and Code | | 15 | | ppm/°C |

ELECTRICAL CHARACTERISTICS: $AV_{DD} = 3V$ (Cont.)

All specifications T_{MIN} to T_{MAX} , $AV_{DD} = +3V$, $DV_{DD} = +2.7V$ to $5.25V$, $f_{MOD} = 19.2kHz$, $PGA = 1$, Buffer ON, $R_{DAC} = 75k\Omega$, $f_{DATA} = 10Hz$, $V_{REF} \equiv (REF IN+) - (REF IN-) = +1.25V$ unless otherwise specified.

| PARAMETER | CONDITIONS | ADS1216 | | | UNITS |
|---|--|---------|-----|------|-------------|
| | | MIN | TYP | MAX | |
| POWER-SUPPLY REQUIREMENTS | | | | | |
| Power-Supply Voltage | AV_{DD} | 2.7 | | 3.3 | V |
| Analog Current ($I_{ADC} + I_{VREF} + I_{DAC}$) | PDWN = 0, or SLEEP | | 1 | | nA |
| ADC Current (I_{ADC}) | PGA = 1, Buffer OFF | | 120 | 200 | μA |
| | PGA = 128, Buffer OFF | | 370 | 600 | μA |
| | PGA = 1, Buffer ON | | 170 | 250 | μA |
| | PGA = 128, Buffer ON | | 750 | 1200 | μA |
| V_{REF} Current (I_{VREF}) | | | 250 | 375 | μA |
| I_{DAC} Current (I_{DAC}) | Excludes Load Current | | 480 | 675 | μA |
| Digital Current | Normal Mode, $DV_{DD} = 3V$ | | 90 | 200 | μA |
| | SLEEP Mode, $DV_{DD} = 3V$ | | 75 | | μA |
| | Read Data Continuous Mode, $DV_{DD} = 3V$ | | 113 | | μA |
| | PDWN = 0 | | 1 | | nA |
| Power Dissipation | PGA = 1, Buffer OFF, REFEN = 0, I_{DACS} OFF, $DV_{DD} = 3V$ | | 0.6 | 1.2 | mW |
| TEMPERATURE RANGE | | | | | |
| Operating | | -40 | | +85 | $^{\circ}C$ |
| Storage | | -60 | | +100 | $^{\circ}C$ |

NOTES: (1) Calibration can minimize these errors. (2) ΔV_{OUT} is change in digital result. (3) 12pF switched capacitor at f_{SAMP} clock frequency.

DIGITAL SPECIFICATIONS: T_{MIN} to T_{MAX} , $DV_{DD} 2.7V$ to $5.25V$

| PARAMETER | CONDITIONS | MIN | TYP | MAX | UNITS |
|--------------------------------|-----------------|---------------------|------|---------------------|---------|
| Digital Input/Output | | | | | |
| Logic Family | | | CMOS | | |
| Logic Level: V_{IH} | | $0.8 \cdot DV_{DD}$ | | DV_{DD} | V |
| V_{IL} | | DGND | | $0.2 \cdot DV_{DD}$ | V |
| V_{OH} | $I_{OH} = 1mA$ | $DV_{DD} - 0.4$ | | | V |
| V_{OL} | $I_{OL} = 1mA$ | DGND | | DGND + 0.4 | V |
| Input Leakage: I_{IH} | $V_I = DV_{DD}$ | | | 10 | μA |
| | $V_I = 0$ | -10 | | | μA |
| Master Clock Rate: f_{OSC} | | 1 | | 5 | MHz |
| Master Clock Period: t_{OSC} | $1/f_{OSC}$ | 200 | | 1000 | ns |

PIN CONFIGURATION

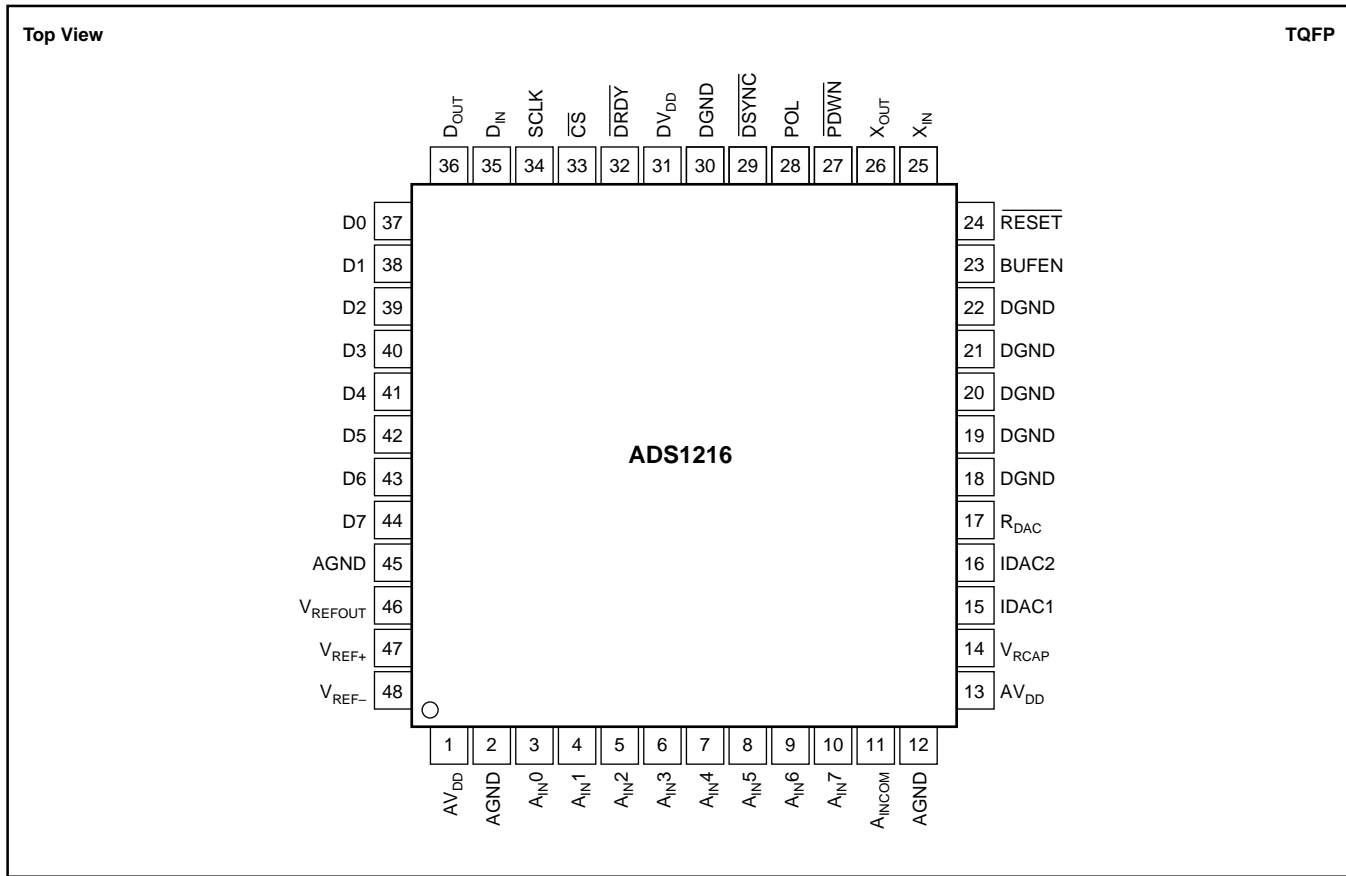

PIN DESCRIPTIONS

| PIN NUMBER | NAME | DESCRIPTION | PIN NUMBER | NAME | DESCRIPTION |
|------------|--------------------|-------------------------------------|------------|---------------------|---|
| 1 | AV _{DD} | Analog Power Supply | 25 | X _{IN} | Clock Input |
| 2 | AGND | Analog Ground | 26 | X _{OUT} | Clock Output, used with crystal or resonator. |
| 3 | A _{IN0} | Analog Input 0 | 27 | PDWN | Active LOW. Power Down. The power down function shuts down the analog and digital circuits. |
| 4 | A _{IN1} | Analog Input 1 | | | |
| 5 | A _{IN2} | Analog Input 2 | 28 | POL | Serial Clock Polarity |
| 6 | A _{IN3} | Analog Input 3 | 29 | DSYNC | Active LOW, Synchronization Control |
| 7 | A _{IN4} | Analog Input 4 | 30 | DGND | Digital Ground |
| 8 | A _{IN5} | Analog Input 5 | 31 | DV _{DD} | Digital Power Supply |
| 9 | A _{IN6} | Analog Input 6 | 32 | DRDY | Active LOW, Data Ready |
| 10 | A _{IN7} | Analog Input 7 | 33 | CS | Active LOW, Chip Select |
| 11 | A _{INCOM} | Analog Input Common | 34 | SCLK | Serial Clock, Schmitt Trigger |
| 12 | AGND | Analog Ground | 35 | D _{IN} | Serial Data Input, Schmitt Trigger |
| 13 | AV _{DD} | Analog Power Supply | 36 | D _{OUT} | Serial Data Output |
| 14 | V _{RCAP} | V _{REF} Bypass CAP | 37-44 | D0-D7 | Digital I/O 0-7 |
| 15 | IDAC1 | Current DAC1 Output | 45 | AGND | Analog Ground |
| 16 | IDAC2 | Current DAC2 Output | 46 | V _{REFOUT} | Voltage Reference Output |
| 17 | R _{DAC} | Current DAC Resistor | 47 | V _{REF+} | Positive Differential Reference Input |
| 18-22 | DGND | Digital Ground | 48 | V _{REF-} | Negative Differential Reference Input |
| 23 | BUFEN | Buffer Enable | | | |
| 24 | RESET | Active LOW, resets the entire chip. | | | |

TIMING DIAGRAMS

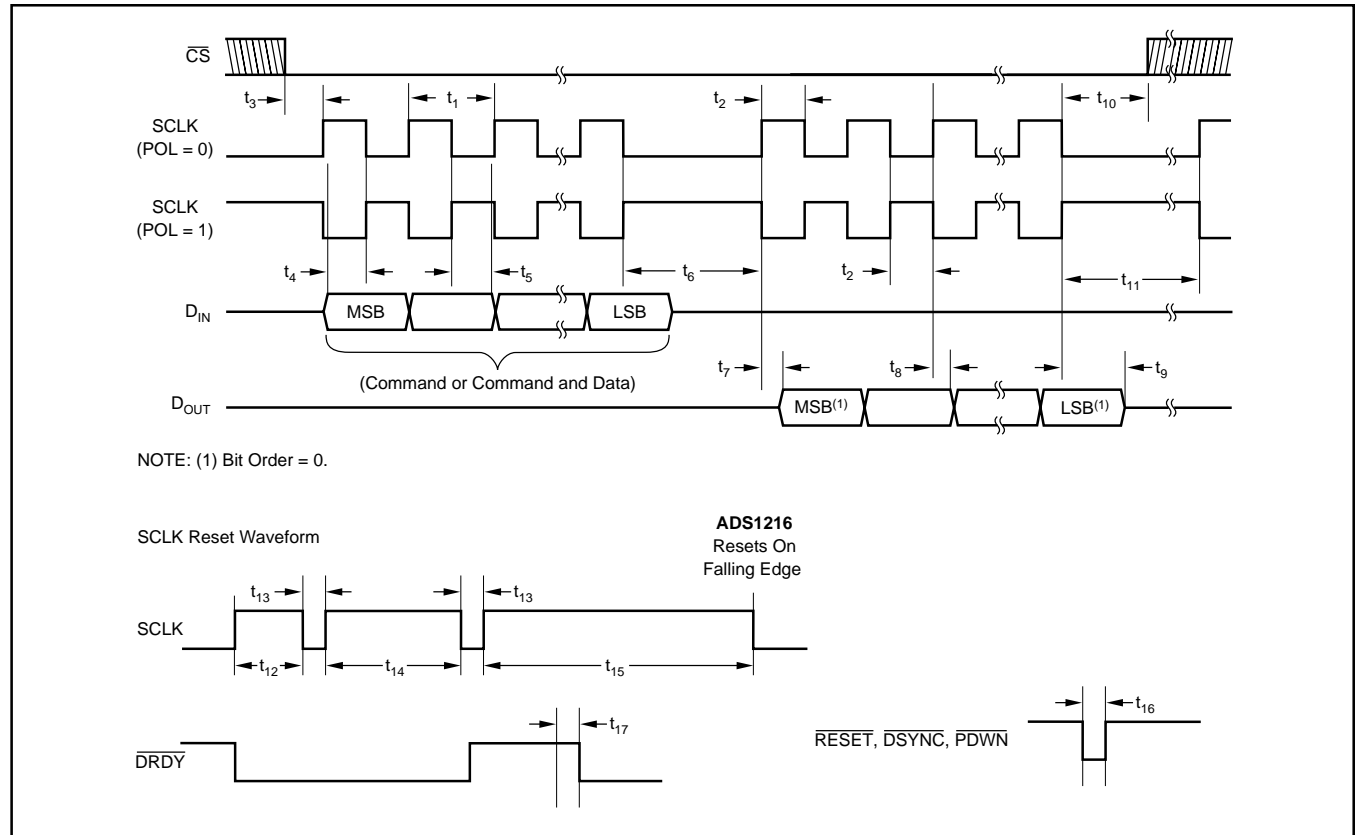

TIMING CHARACTERISTICS

| SPEC | DESCRIPTION | MIN | MAX | UNITS |
|-------------|---|------|------|-----------------------------------|
| t_1 | SCLK Period | 4 | 3 | t_{OSC} Periods DRDY Periods |
| t_2 | SCLK Pulse Width, HIGH and LOW | 200 | | ns |
| t_3 | \overline{CS} LOW to first SCLK Edge; Setup Time ⁽²⁾ | 0 | | ns |
| t_4 | D_{IN} Valid to SCLK Edge; Setup Time | 50 | | ns |
| t_5 | Valid D_{IN} to SCLK Edge; Hold Time | 50 | | ns |
| t_6 | Delay between last SCLK edge for D_{IN} and first SCLK edge for D_{OUT} : | | | |
| | RDATA, RDATA, RREG, WREG, RRAM, WRAM | 50 | | t_{OSC} Periods |
| | CSREG, CSRAMX, CSRAM | 200 | | t_{OSC} Periods |
| | CSARAM, CSARAMX | 1100 | | t_{OSC} Periods |
| $t_7^{(1)}$ | SCLK Edge to Valid New D_{OUT} | | 50 | ns |
| $t_8^{(1)}$ | SCLK Edge to D_{OUT} Hold Time | 0 | | ns |
| t_9 | Last SCLK Edge to D_{OUT} Tri-State NOTE: D_{OUT} goes tri-state immediately when \overline{CS} goes HIGH. | 6 | 10 | t_{OSC} Periods |
| t_{10} | \overline{CS} LOW time after final SCLK edge | 0 | | ns |
| t_{11} | Final SCLK edge of one op code until first edge SCLK of next command: | | | |
| | RREG, WREG, RRAM, WRAM, CSRAMX, CSARAMX, CSRAM, CSARAM, CSREG, DSYNC, SLEEP, RDATA, RDATA, STOPC | 4 | | t_{OSC} Periods |
| | CREG, CRAM | 220 | | t_{OSC} Periods |
| | CREGA | 1600 | | t_{OSC} Periods |
| | SELFGCAL, SELFOCAL, SYSOCAL, SYSGCAL | 7 | | DRDY Periods |
| | SELFCAL | 14 | | DRDY Periods |
| | RESET (Command, SCLK or Pin) | 16 | | t_{OSC} Periods |
| t_{12} | | 300 | 500 | t_{OSC} Periods |
| t_{13} | | 5 | | t_{OSC} Periods |
| t_{14} | | 550 | 750 | t_{OSC} Periods |
| t_{15} | | 1050 | 1250 | t_{OSC} Periods |
| t_{16} | Pulse Width | 4 | | t_{OSC} Periods |
| t_{17} | DOR Data Not Valid | 4 | | t_{OSC} Periods |

NOTE: (1) Load = 20pF || 10kΩ to DGND. (2) \overline{CS} may be tied LOW.

TYPICAL CHARACTERISTICS

$V_{DD} = +5V$, $DV_{DD} = +5V$, $f_{OSC} = 2.4576MHz$, $PGA = 1$, $R_{DAC} = 150k\Omega$, $f_{DATA} = 10Hz$, $V_{REF} \equiv (REF IN+) - (REF IN-) = +2.5V$, unless otherwise specified.

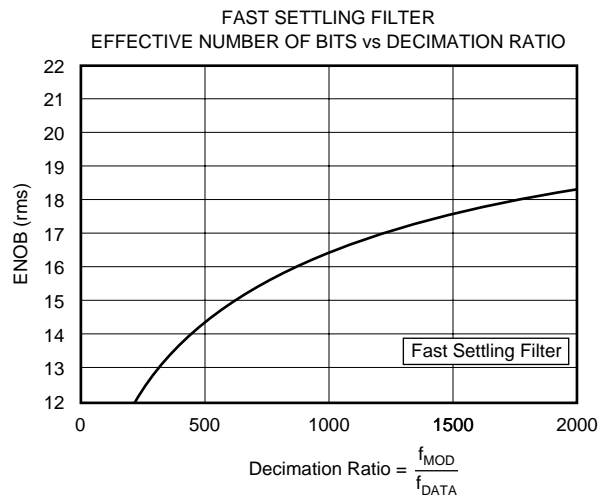
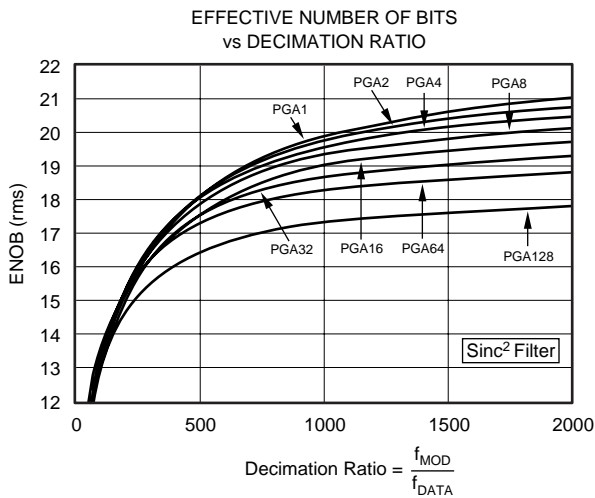
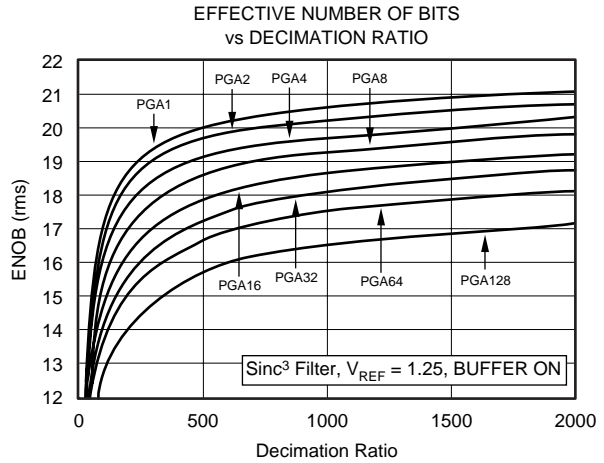
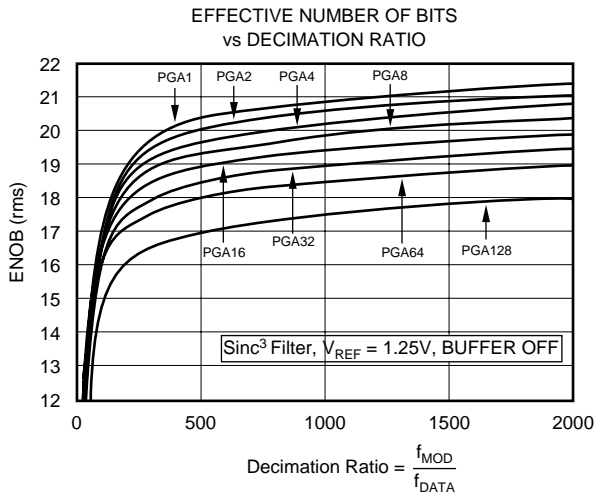
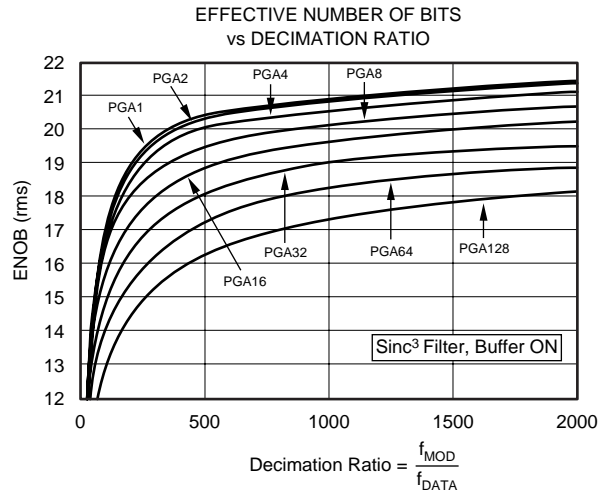
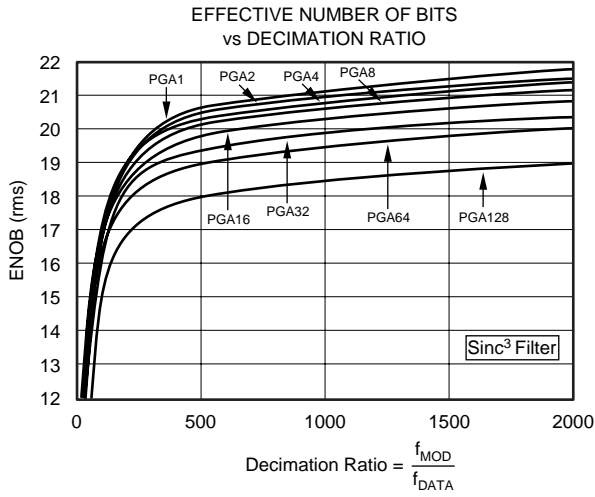

TYPICAL CHARACTERISTICS (Cont.)

$V_{DD} = +5V$, $DV_{DD} = +5V$, $f_{OSC} = 2.4576MHz$, $PGA = 1$, $R_{DAC} = 150k\Omega$, $f_{DATA} = 10Hz$, $V_{REF} \equiv (REF\ IN+) - (REF\ IN-) = +2.5V$, unless otherwise specified.

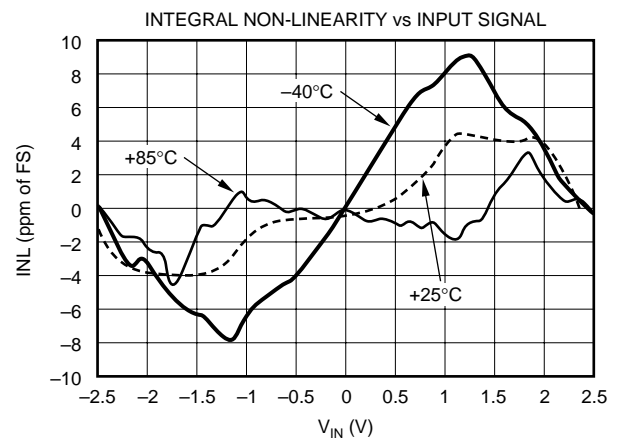
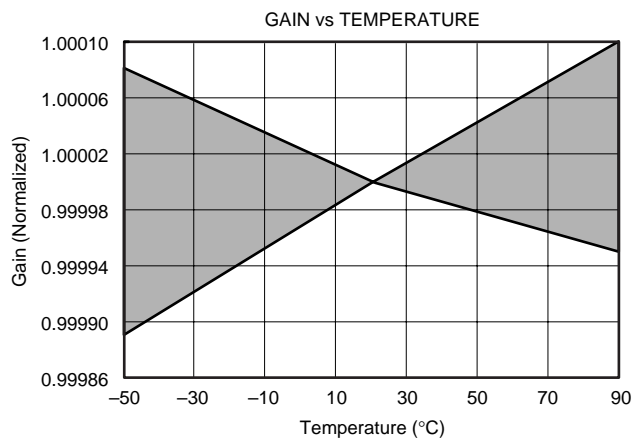
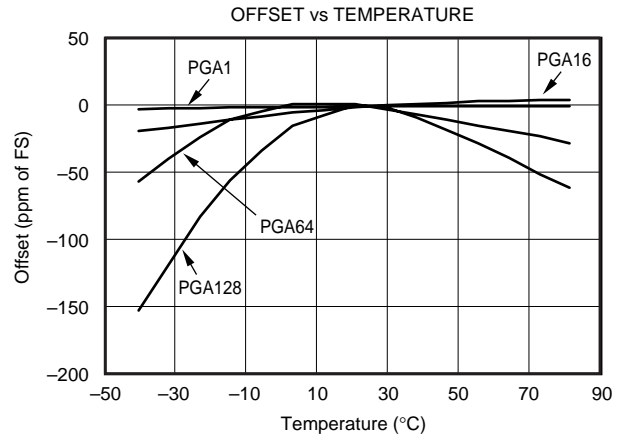
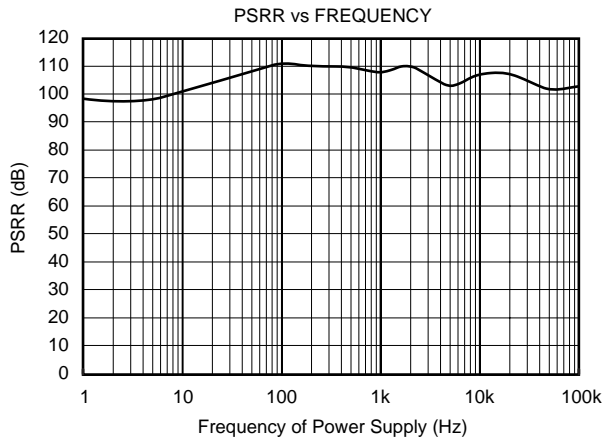
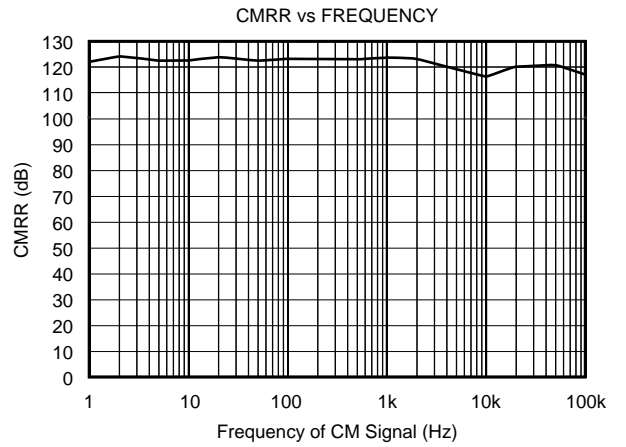
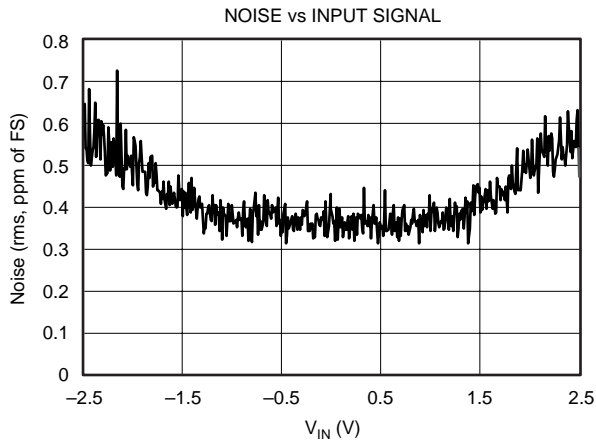

TYPICAL CHARACTERISTICS (Cont.)

$AV_{DD} = +5V$, $DV_{DD} = +5V$, $f_{OSC} = 2.4576MHz$, $PGA = 1$, $R_{DAC} = 150k\Omega$, $f_{DATA} = 10Hz$, $V_{REF} = (REF IN+) - (REF IN-) = +2.5V$, unless otherwise specified.

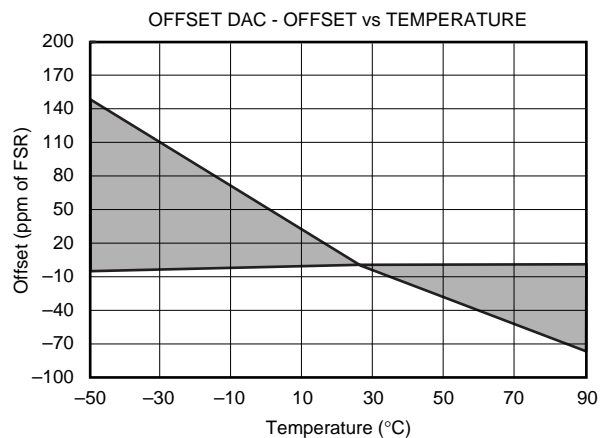
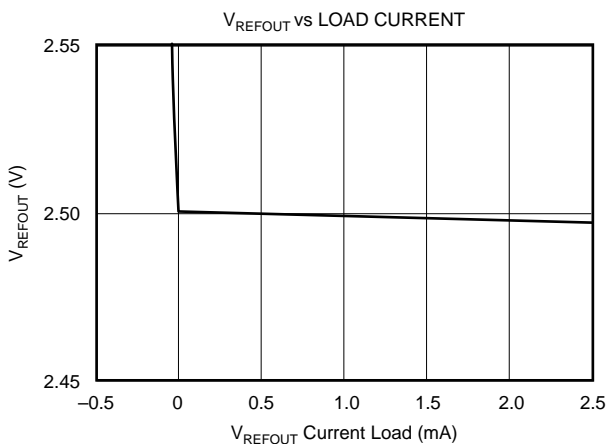
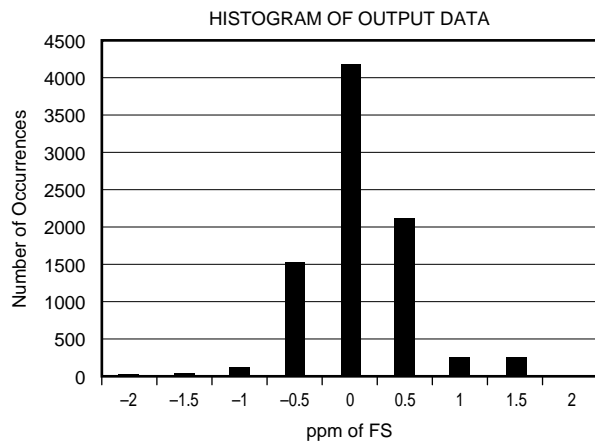
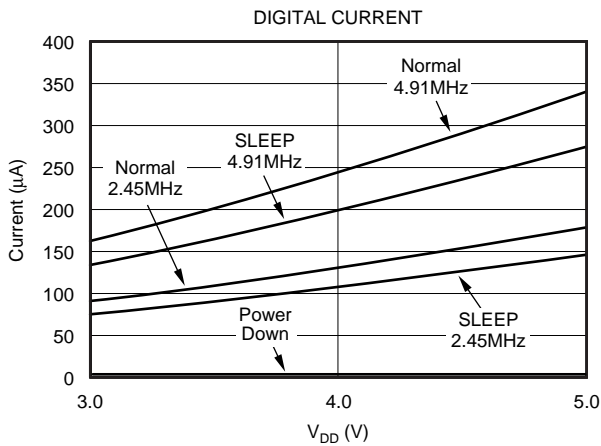
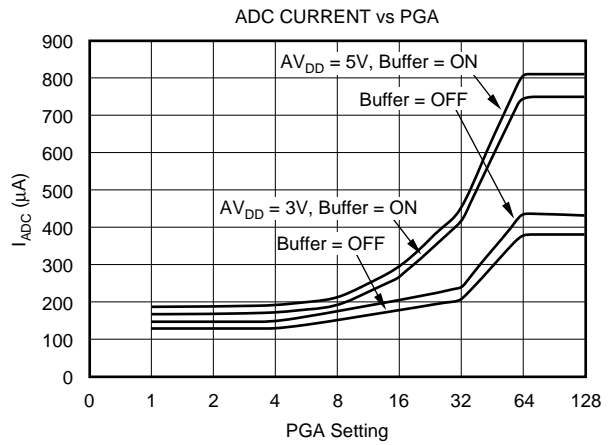
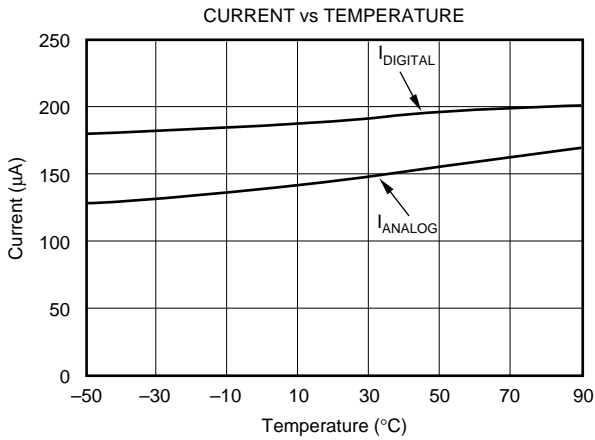

TYPICAL CHARACTERISTICS (Cont.)

$V_{DD} = +5V$, $DV_{DD} = +5V$, $f_{OSC} = 2.4576MHz$, $PGA = 1$, $R_{DAC} = 150k\Omega$, $f_{DATA} = 10Hz$, $V_{REF} \equiv (REF\ IN+) - (REF\ IN-) = +2.5V$, unless otherwise specified.

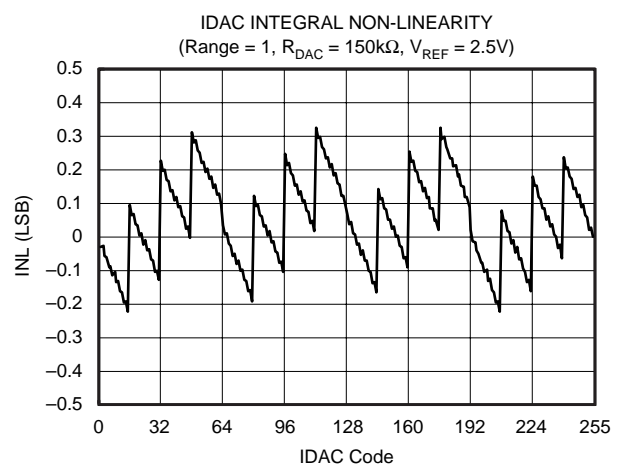
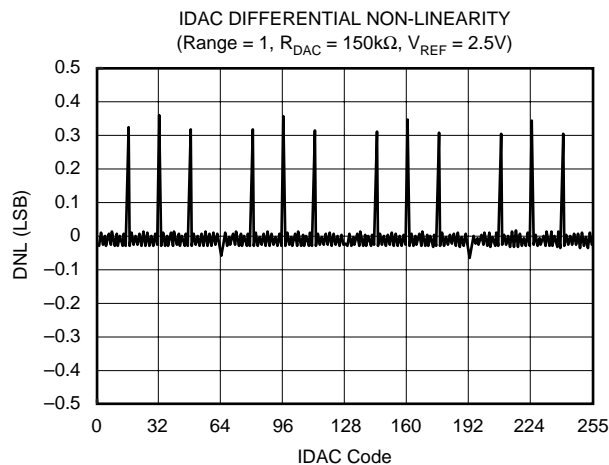
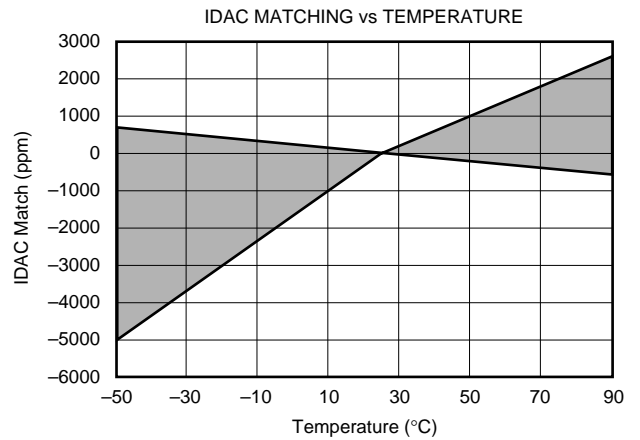
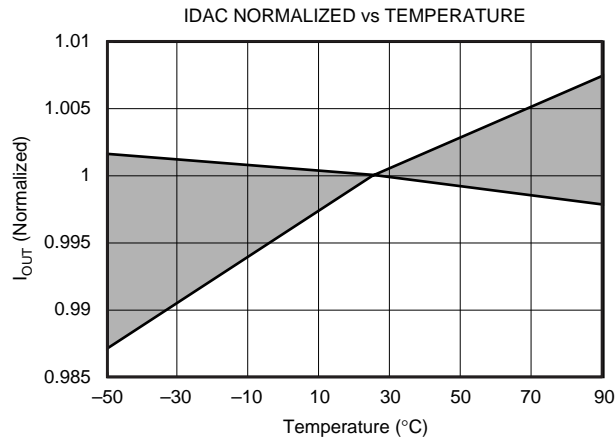
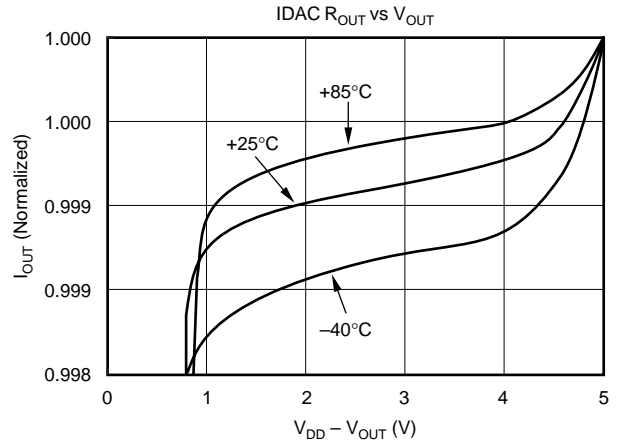
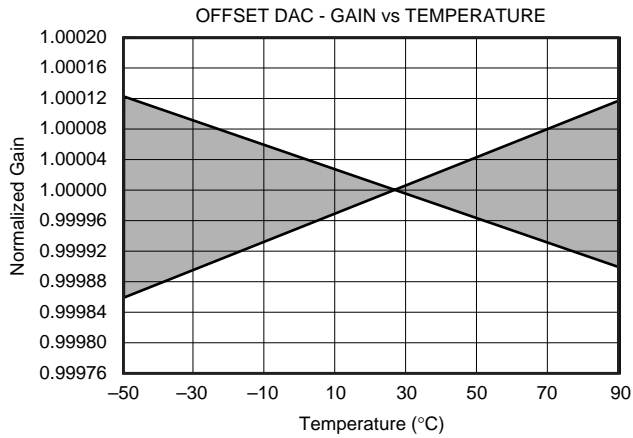

OVERVIEW

INPUT MULTIPLEXER

The input multiplexer provides for any combination of differential inputs to be selected on any of the input channels, as shown in Figure 1. If channel 1 is selected as the positive differential input channel, any other channel can be selected as the negative differential input channel. With this method, it is possible to have up to eight fully differential input channels.

In addition, current sources are supplied that will source or sink current to detect open or short circuits on the pins.

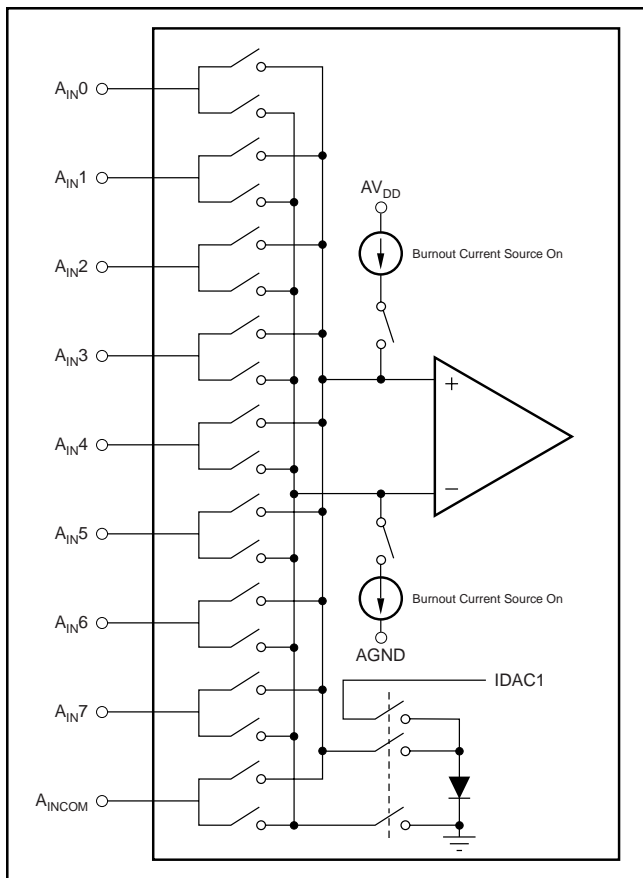

FIGURE 1. Input Multiplexer Configuration.

TEMPERATURE SENSOR

An on-chip diode provides temperature sensing capability. When the configuration register for the input MUX is set to all 1s, the diode is connected to the input of the A/D converter. All other channels are open. The anode of the diode is connected to the positive input of the A/D converter, and the cathode of the diode is connected to negative input of the A/D converter. The output of IDAC1 is connected to the anode to bias the diode and the cathode of the diode is also connected to ground to complete the circuit.

In this mode, the output of IDAC1 is also connected to the output pin, so some current may flow into an external load from IDAC1, rather than the diode.

BURNOUT CURRENT SOURCES

When the Burnout bit is set in the ACR configuration register, two current sources are enabled. The current source on the positive input channel sources approximately $2\mu\text{A}$ of current. The current source on the negative input channel sinks approximately $2\mu\text{A}$. This allows for the detection of an open circuit (full-scale reading) or short circuit (0V differential reading) on the selected input differential pair.

INPUT BUFFER

The input impedance of the ADS1216 without the buffer is $5\text{M}\Omega/\text{PGA}$. With the buffer enabled, the input voltage range is reduced and the analog power-supply current is higher. The buffer is controlled by ANDing the state of the buffer pin with the state of the BUFFER bit in the ACR register.

IDAC1 AND IDAC2

The ADS1216 has two 8-bit current output DACs that can be controlled independently. The output current is set with R_{DAC} , the range select bits in the ACR register, and the 8-bit digital value in the IDAC register. The output current $= V_{\text{REF}} / (8 \cdot R_{\text{DAC}}) (2^{\text{RANGE}-1}) (\text{DAC CODE})$. With $V_{\text{REFOUT}} = 2.5\text{V}$ and $R_{\text{DAC}} = 150\text{k}\Omega$, the full-scale output can be selected to be 0.5, 1, or 2mA. The compliance voltage range is 0 to within 1V of AV_{DD} . When the internal voltage reference of the ADS1216 is used, it is the reference for the IDAC. An external reference may be used for the IDACs by disabling the internal reference and tying the external reference input to the V_{REFOUT} pin.

PGA

The Programmable Gain Amplifier (PGA) can be set to gains of 1, 2, 4, 8, 16, 32, 64, or 128. Using the PGA can actually improve the effective resolution of the A/D converter. For instance, with a PGA of 1 on a 5V full-scale range, the A/D converter can resolve to $1\mu\text{V}$. With a PGA of 128 on a 40mV full-scale range, the A/D converter can resolve to 75nV. With a PGA of 1 on a 5V full-scale range, it would require a 26-bit A/D converter to resolve 76nV.

PGA OFFSET DAC

The input to the PGA can be shifted by half the full-scale input range of the PGA by using the ODAC register. The ODAC (Offset DAC) register is an 8-bit value; the MSB is the sign and the seven LSBs provide the magnitude of the offset. Using the ODAC does not reduce the performance of the A/D.

MODULATOR

The modulator is a single-loop second-order system. The modulator runs at a clock speed (f_{MOD}) that is derived from the external clock (f_{OSC}). The frequency division is determined by the SPEED bit in the setup register.

| SPEED BIT | f_{MOD} |
|-----------|----------------------|
| 0 | $f_{\text{OSC}}/128$ |
| 1 | $f_{\text{OSC}}/256$ |

CALIBRATION

The offset and gain errors in the ADS1216, or the complete system, can be reduced with calibration. Internal calibration of the ADS1216 is called self calibration. This is handled with three commands. One command does both offset and gain calibration. There is also a gain calibration command and an offset calibration command. Each calibration process takes seven t_{DATA} periods to complete. Therefore, it takes 14 t_{DATA} periods to complete both an offset and gain calibration.

For system calibration, the appropriate signal must be applied to the inputs. The system offset command requires a “zero” differential input signal. It then computes an offset that will nullify offset in the system. The system gain command requires a positive “full-scale” differential input signal. It then computes a value to nullify gain errors in the system. Each of these calibrations will take seven t_{DATA} periods to complete.

Calibration should be performed after power on, a change in temperature, or a change of the PGA. The RANGE bit (ACR bit 2) must be zero during calibration. For operation with a reference voltage greater than $(AV_{DD} - 1.5)$ Volts, the buffer must also be turned off during calibration. Calibration will remove the effects of the ODAC, therefore, changes to the ODAC register must be done after calibration, otherwise the calibration will remove the effects of the offset.

At the completion of calibration the \overline{DRDY} signal goes low which indicates the calibration is finished and valid data is available.

DIGITAL FILTER

The Digital Filter can use either the fast settling, sinc^2 , or sinc^3 filter, as shown in Figure 2. In addition, the Auto mode changes the sinc filter after the input channel or PGA is changed. When switching to a new channel, it will use the fast

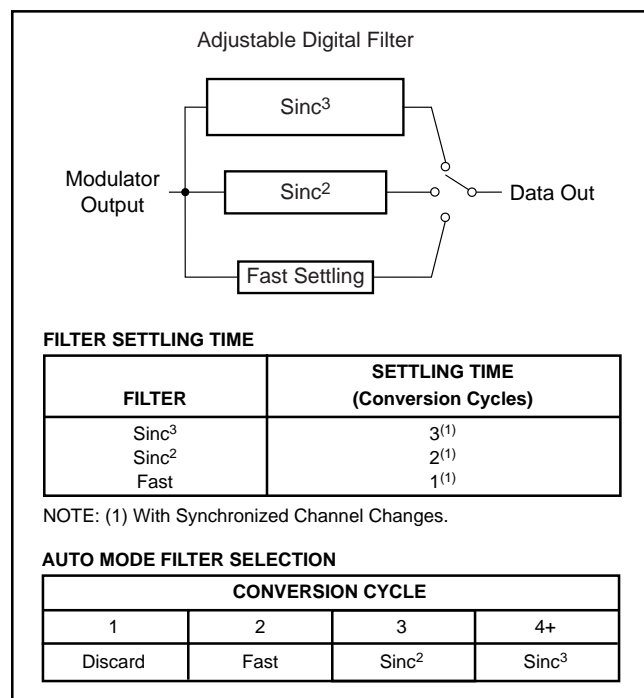

FIGURE 2. Filter Step Responses.

settling filter, for the next two conversions the first of which should be discarded. It will then use the sinc^2 followed by the sinc^3 filter to improve noise performance. This combines the low-noise advantage of the sinc^3 filter with the quick response of the fast settling time filter. The frequency response of each filter is shown in Figure 3.

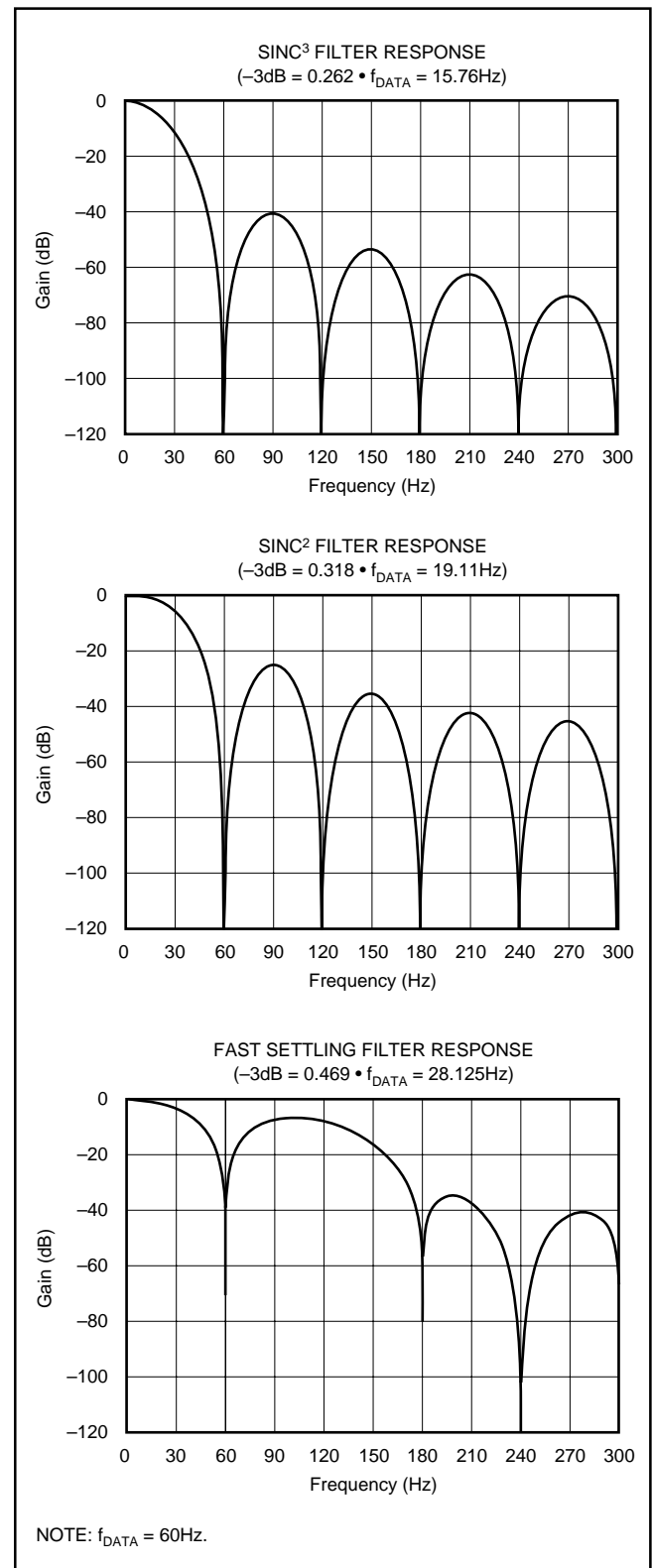

FIGURE 3. Filter Frequency Responses.

VOLTAGE REFERENCE

The voltage reference used for the ADS1216 can either be internal or external. The power-up configuration for the voltage reference is 2.5V internal. The selection for the voltage reference is made through the status configuration register.

The internal voltage reference is selectable as either 1.25V or 2.5V ($AV_{DD} = 5V$ only). The V_{REFOUT} pin should have a $0.1\mu F$ capacitor to AGND.

The external voltage reference is differential and is represented by the voltage difference between the pins: $+V_{REF}$ and $-V_{REF}$. The absolute voltage on either pin ($+V_{REF}$ and $-V_{REF}$) can range from AGND to AV_{DD} , however, the differential voltage must not exceed 2.5V. The differential voltage reference provides easy means of performing ratiometric measurement.

V_{RCAP} PIN

This pin provides a bypass cap for noise filtering on internal V_{REF} circuitry only. The recommended capacitor is a $0.001\mu F$ ceramic cap. If an external V_{REF} is used, this pin can be left unconnected.

CLOCK GENERATOR

The clock source for the ADS1216 can be provided from a crystal, ceramic resonator, oscillator, or external clock. When the clock source is a crystal or ceramic resonator, external capacitors must be provided to ensure start-up and a stable clock frequency. This is shown in Figure 4 and Table I.

DIGITAL I/O INTERFACE

The ADS1216 has eight pins dedicated for digital I/O. The default power-up condition for the digital I/O pins are as inputs. All of the digital I/O pins are individually configurable

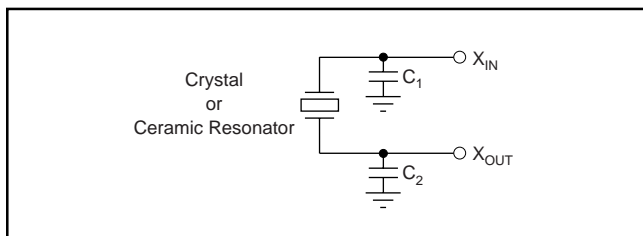

FIGURE 4. Crystal or Ceramic Resonator Connection.

| CLOCK SOURCE | FREQUENCY | C ₁ | C ₂ | PART NUMBER |
|--------------|-----------|----------------|----------------|---------------------|
| Crystal | 2.4576 | 0-20pF | 0-20pF | ECS, ECSD 2.45 - 32 |
| Crystal | 4.9152 | 0-20pF | 0-20pF | ECS, ECSL 4.91 |
| Crystal | 4.9152 | 0-20pF | 0-20pF | ECS, ECSD 4.91 |
| Crystal | 4.9152 | 0-20pF | 0-20pF | CTS, MP 042 4M9182 |

TABLE I. Typical Clock Sources.

as inputs or outputs. They are configured through the DIR control register. The DIR register defines whether the pin is an input or output, and the DIO register defines the state of the digital output. When the digital I/O are configured as inputs, DIO is used to read the state of the pin.

SERIAL INTERFACE

The serial interface is standard four-wire SPI compatible (D_{IN} , D_{OUT} , SCLK, and \overline{CS}). The ADS1216 also offers the flexibility to select the polarity of the serial clock through the POL pin. The serial interface can be clocked up to $f_{OSC}/4$.

Serial communication can occur independent of DRDY, DRDY only indicates the validity of data in the data output register.

\overline{DSYNC} OPERATION

\overline{DSYNC} is used to provide for precise synchronization of the A/D conversion with an external event. Synchronization can be achieved either through the \overline{DSYNC} pin or the \overline{DSYNC} command. When the \overline{DSYNC} pin is used, the filter counter is reset on the falling edge of \overline{DSYNC} . The filter values are useless, they should be treated as if the input channel was changed. The modulator is held in reset until \overline{DSYNC} is taken HIGH. Synchronization occurs on the next rising edge of the system clock after \overline{DSYNC} is taken HIGH.

When the \overline{DSYNC} command is sent, the filter counter is reset on the edge of the last SCLK on the \overline{DSYNC} command. The modulator is held in RESET until the next edge of SCLK is detected. Synchronization occurs on the next rising edge of the system clock after the first SCLK after the \overline{DSYNC} command.

POWER-UP—SUPPLY VOLTAGE RAMP RATE

The power-on reset circuitry was designed to accommodate digital supply ramp rates as slow as 1V/10ms. To ensure proper operation, the power supply should ramp monotonically.

RESET

There are three methods of reset. The RESET pin, SCLK pattern, and the RESET command. They all perform the same function. The Power ON state also issues the RESET command.

MEMORY

Two types of memory are used on the ADS1216: registers and RAM. 16 registers directly control the various functions (PGA, DAC value, Decimation Ratio, etc.) and can be directly read or written to. Collectively, the registers contain all the information needed to configure the part, such as data format, mux settings, calibration settings, decimation ratio, etc. Additional registers, such as output data, are accessed through dedicated instructions.

ADS1216 REGISTER BANK TOPOLOGY

The operation of the device is set up through individual registers. The set of the 16 registers required to configure the device is referred to as a Register Bank, as shown in Figure 5.

Reads and Writes to Registers and RAM occur on a byte basis. However, copies between registers and RAM occurs on a bank basis. The RAM is independent of the Registers, i.e.: the RAM can be used as general-purpose RAM.

The ADS1216 supports any combination of eight analog inputs. With this flexibility, the device could easily support eight unique configurations—one per input channel. In order to facilitate this type of usage, eight separate register banks are available. Therefore, each configuration could be written once and recalled as needed without having to serially retransmit all the configuration data. Checksum commands are also included, which can be used to verify the integrity of RAM.

The RAM provides eight “banks”, with a bank consisting of 16 bytes. The total size of the RAM is 128 bytes. Copies between the registers and RAM are performed on a bank basis. Also, the RAM can be directly read or written through the serial interface on power-up. The banks allow separate storage of settings for each input.

The RAM address space is linear, therefore accessing RAM is done using an auto-incrementing pointer. Access to RAM in the entire memory map can be done consecutively without having to address each bank individually. For example, if you were currently accessing bank 0 at offset 0xF (the last location of bank 0), the next access would be bank 1 and offset 0x0. Any access after bank 7 and offset 0xF will wrap around to bank 0 and Offset 0x0.

Although the Register Bank memory is linear, the concept of addressing the device can also be thought of in terms of bank and offset addressing. Looking at linear and bank addressing syntax, we have the following comparison: in the linear

memory map, the address 0x14 is equivalent to bank 1 and offset 0x4. Simply stated, the most significant four bits represent the bank, and the least significant four bits represent the offset. The offset is equivalent to the register address for that bank of memory.

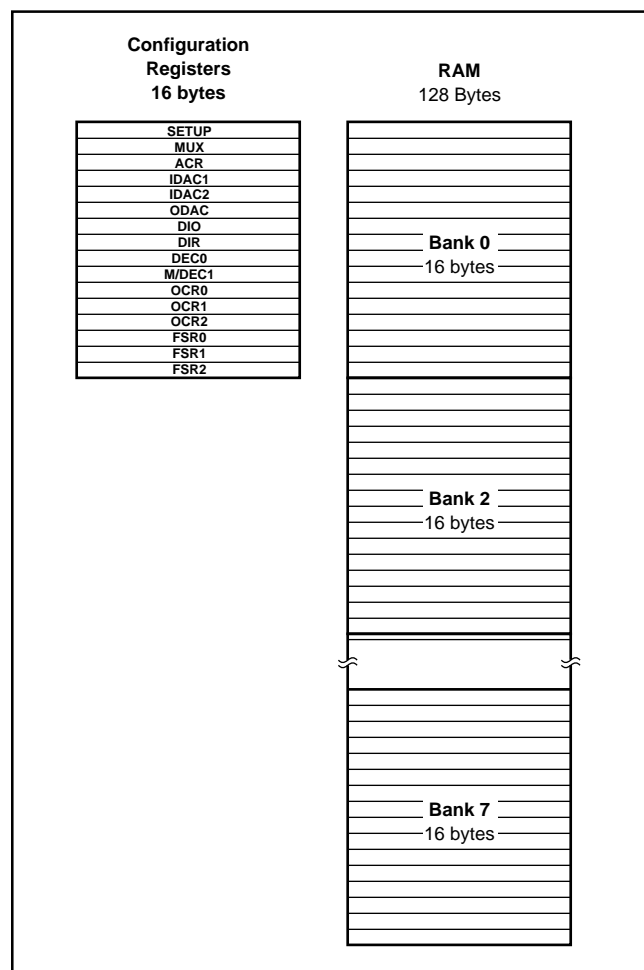

FIGURE 5. Memory Organization.

| ADDRESS | REGISTER | BIT 7 | BIT 6 | BIT 5 | BIT 4 | BIT 3 | BIT 2 | BIT 1 | BIT 0 |
|-----------------|----------|---------|---------|---------|---------|----------|---------|---------|-----------|
| 00 _H | SETUP | ID | ID | ID | SPEED | REF EN | REF HI | BUF EN | BIT ORDER |
| 01 _H | MUX | PSEL3 | PSEL2 | PSEL1 | PSEL0 | NSEL3 | NSEL2 | NSEL1 | NSEL0 |
| 02 _H | ACR | BOCS | IDAC2R1 | IDAC2R0 | IDAC1R1 | IDAC1R0 | PGA2 | PGA1 | PGA0 |
| 03 _H | IDAC1 | IDAC1_7 | IDAC1_6 | IDAC1_5 | IDAC1_4 | IDAC1_3 | IDAC1_2 | IDAC1_1 | IDAC1_0 |
| 04 _H | IDAC2 | IDAC2_7 | IDAC2_6 | IDAC2_5 | IDAC2_4 | IDAC2_3 | IDAC2_2 | IDAC2_1 | IDAC2_0 |
| 05 _H | ODAC | SIGN | OSET_6 | OSET_5 | OSET_4 | OSET_3 | OSET_2 | OSET_1 | OSET_0 |
| 06 _H | DIO | DIO_7 | DIO_6 | DIO_5 | DIO_4 | DIO_3 | DIO_2 | DIO_1 | DIO_0 |
| 07 _H | DIR | DIR_7 | DIR_6 | DIR_5 | DIR_4 | DIR_3 | DIR_2 | DIR_1 | DIR_0 |
| 08 _H | DEC0 | DEC07 | DEC06 | DEC05 | DEC04 | DEC03 | DEC02 | DEC01 | DEC00 |
| 09 _H | M/DEC1 | DRDY | U/B | SMODE1 | SMODE0 | Reserved | DEC10 | DEC09 | DEC08 |
| 0A _H | OCR0 | OCR07 | OCR06 | OCR05 | OCR04 | OCR03 | OCR02 | OCR01 | OCR00 |
| 0B _H | OCR1 | OCR15 | OCR14 | OCR13 | OCR12 | OCR11 | OCR10 | OCR09 | OCR08 |
| 0C _H | OCR2 | OCR23 | OCR22 | OCR21 | OCR20 | OCR19 | OCR18 | OCR17 | OCR16 |
| 0D _H | FSR0 | FSR07 | FSR06 | FSR05 | FSR04 | FSR03 | FSR02 | FSR01 | FSR00 |
| 0E _H | FSR1 | FSR15 | FSR14 | FSR13 | FSR12 | FSR11 | FSR10 | FSR09 | FSR08 |
| 0F _H | FSR2 | FSR23 | FSR22 | FSR21 | FSR20 | FSR19 | FSR18 | FSR17 | FSR16 |

TABLE II. Registers.

DETAILED REGISTER DEFINITIONS

SETUP (Address 00_H) Setup Register

Reset Value = iii01110

| bit 7 | bit 6 | bit 5 | bit 4 | bit 3 | bit 2 | bit 1 | bit 0 |
|-------|-------|-------|-------|--------|--------|--------|-----------|
| ID | ID | ID | SPEED | REF EN | REF HI | BUF EN | BIT ORDER |

bit 7-5 Factory Programmed Bits

bit 4 SPEED: Modulator Clock Speed

0 : $f_{MOD} = f_{OSC}/128$ (default)

1 : $f_{MOD} = f_{OSC}/256$

bit 3 REF EN: Internal Voltage Reference Enable

0 = Internal Voltage Reference Disabled

1 = Internal Voltage Reference Enabled (default)

bit 2 REF HI: Internal Reference Voltage Select

0 = Internal Reference Voltage = 1.25V

1 = Internal Reference Voltage = 2.5V (default)

bit 1 BUF EN: Buffer Enable

0 = Buffer Disabled

1 = Buffer Enabled (default)

bit 0 BIT ORDER: Set Order Bits are Transmitted

0 = Most Significant Bit Transmitted First (default)

1 = Least Significant Bit Transmitted First

Data is always shifted into the part most significant bit first. Data is always shifted out of the part most significant byte first. This configuration bit only controls the bit order within the byte of data that is shifted out.

MUX (Address 01_H) Multiplexer Control Register

Reset Value = 01_H

| bit 7 | bit 6 | bit 5 | bit 4 | bit 3 | bit 2 | bit 1 | bit 0 |
|-------|-------|-------|-------|-------|-------|-------|-------|
| PSEL3 | PSEL2 | PSEL1 | PSEL0 | NSEL3 | NSEL2 | NSEL1 | NSEL0 |

bit 7-4 PSEL3: PSEL2: PSEL1: PSEL0: Positive Channel Select

0000 = AIN0 (default)

0001 = AIN1

0010 = AIN2

0011 = AIN3

0100 = AIN4

0101 = AIN5

0110 = AIN6

0111 = AIN7

1xxx = AINCOM (except when all bits are 1's)

1111 = Temperature Sensor Diode Anode

bit 3-0 NSEL3: NSEL2: NSEL1: NSEL0: Negative Channel Select

0000 = AIN0

0001 = AIN1 (default)

0010 = AIN2

0011 = AIN3

0100 = AIN4

0101 = AIN5

0110 = AIN6

0111 = AIN7

1xxx = AINCOM (except when all bits are 1's)

1111 = Temperature Sensor Diode Cathode Analog GND

ACR (Address 02_H) Analog Control Register

Reset Value = 00_H

| bit 7 | bit 6 | bit 5 | bit 4 | bit 3 | bit 2 | bit 1 | bit 0 |
|-------|---------|---------|---------|---------|-------|-------|-------|
| BOCS | IDAC2R1 | IDAC2R0 | IDAC1R1 | IDAC1R0 | PGA2 | PGA1 | PGA0 |

bit 7 BOCS: Burnout Current Source

0 = Disabled (default)

1 = Enabled

$$\text{IDAC Current} = \left(\frac{V_{REF}}{8 \cdot R_{DAC}} \right) (2^{\text{RANGE}-1}) (\text{DAC Code})$$

bit 6-5 IDAC2R1: IDAC2R0: Full-Scale Range Select for IDAC2

00 = Off (default)

01 = Range 1

10 = Range 2

11 = Range 3

bit 4-3 IDAC1R1: IDAC1R0: Full-Scale Range Select for IDAC1

00 = Off (default)

01 = Range 1

10 = Range 2

11 = Range 3

bit 2-0 PGA2: PGA1: PGA0: Programmable Gain Amplifier

Gain Selection

000 = 1 (default)

001 = 2

010 = 4

011 = 8

100 = 16

101 = 32

110 = 64

111 = 128

IDAC1 (Address 03_H) Current DAC 1

Reset Value = 00_H

| bit 7 | bit 6 | bit 5 | bit 4 | bit 3 | bit 2 | bit 1 | bit 0 |
|---------|---------|---------|---------|---------|---------|---------|---------|
| IDAC1_7 | IDAC1_6 | IDAC1_5 | IDAC1_4 | IDAC1_3 | IDAC1_2 | IDAC1_1 | IDAC1_0 |

The DAC code bits set the output of DAC1 from 0 to full-scale. The value of the full-scale current is set by this Byte, V_{REF} , R_{DAC} , and the DAC1 range bits in the ACR register.

IDAC2 (Address 04_H) Current DAC 2

Reset Value = 00_H

| bit 7 | bit 6 | bit 5 | bit 4 | bit 3 | bit 2 | bit 1 | bit 0 |
|---------|---------|---------|---------|---------|---------|---------|---------|
| IDAC2_7 | IDAC2_6 | IDAC2_5 | IDAC2_4 | IDAC2_3 | IDAC2_2 | IDAC2_1 | IDAC2_0 |

The DAC code bits set the output of DAC2 from 0 to full-scale. The value of the full-scale current is set by this Byte, V_{REF} , R_{DAC} , and the DAC2 range bits in the ACR register.

ODAC (Address 05_H) Offset DAC Setting

Reset Value = 00_H

| bit 7 | bit 6 | bit 5 | bit 4 | bit 3 | bit 2 | bit 1 | bit 0 |
|-------|-------|-------|-------|-------|-------|-------|-------|
| SIGN | OSET6 | OSET5 | OSET4 | OSET3 | OSET2 | OSET1 | OSET0 |

bit 7 Offset Sign

0 = Positive

1 = Negative

$$\text{bit 6-0 Offset} = \frac{V_{\text{REF}}}{2 \cdot \text{PGA}} \cdot \left(\frac{\text{Code}}{127} \right)$$

NOTE: The offset must be used after calibration or the calibration will notify the effects.

DIO (Address 06_H) Digital I/O Reset Value = 00_H

| bit 7 | bit 6 | bit 5 | bit 4 | bit 3 | bit 2 | bit 1 | bit 0 |
|-------|-------|-------|-------|-------|-------|-------|-------|
| DIO7 | DIO6 | DIO5 | DIO4 | DIO3 | DIO2 | DIO1 | DIO0 |

A value written to this register will appear on the digital I/O pins if the pin is configured as an output in the DIR register. Reading this register will return the value of the digital I/O pins.

DIR (Address 07_H) Direction control for digital I/O

Reset Value = FF_H

| bit 7 | bit 6 | bit 5 | bit 4 | bit 3 | bit 2 | bit 1 | bit 0 |
|-------|-------|-------|-------|-------|-------|-------|-------|
| DIR7 | DIR6 | DIR5 | DIR4 | DIR3 | DIR2 | DIR1 | DIR0 |

Each bit controls whether the Digital I/O pin is an output (= 0) or input (= 1). The default power-up state is as inputs.

DEC0 (Address 08_H) Decimation Register (Least Significant 8 bits)

Reset Value = 80_H

| bit 7 | bit 6 | bit 5 | bit 4 | bit 3 | bit 2 | bit 1 | bit 0 |
|-------|-------|-------|-------|-------|-------|-------|-------|
| DEC07 | DEC06 | DEC05 | DEC04 | DEC03 | DEC02 | DEC01 | DEC00 |

The decimation value is defined with 11 bits for a range of 20 to 2047. This register is the least significant 8 bits. The 3 most significant bits are contained in the M/DEC1 register. The default data rate is 10Hz with a 2.4576MHz crystal.

M/DEC1 (Address 09_H) Mode and Decimation Register

Reset Value = 07_H

| bit 7 | bit 6 | bit 5 | bit 4 | bit 3 | bit 2 | bit 1 | bit 0 |
|-------|-------|--------|--------|----------|-------|-------|-------|
| DRDY | U/B | SMODE1 | SMODE0 | Reserved | DEC10 | DEC09 | DEC08 |

bit 7 $\overline{\text{DRDY}}$: Data Ready (Read Only)

This bit duplicates the state of the $\overline{\text{DRDY}}$ pin.

bit 6 $\overline{\text{U/B}}$: Data Format

0 = Bipolar (default)

1 = Unipolar

| U/B | ANALOG INPUT | DIGITAL OUTPUT |
|-----|--------------|----------------|
| 0 | +FS | 0x7FFFFF |
| | Zero | 0x000000 |
| | -FS | 0x800000 |
| 1 | +FS | 0xFFFFF |
| | Zero | 0x000000 |
| | -FS | 0x000000 |

bit 5-4 SMODE1: SMODE0: Settling Mode

00 = Auto (default)

01 = Fast Settling filter

10 = Sinc² filter

11 = Sinc³ filter

bit 2-0 DEC10: DEC09: DEC08: Most Significant Bits of the Decimation Value

OCR0 (Address 0A_H) Offset Calibration Coefficient (Least Significant Byte)

Reset Value = 00_H

| bit 7 | bit 6 | bit 5 | bit 4 | bit 3 | bit 2 | bit 1 | bit 0 |
|-------|-------|-------|-------|-------|-------|-------|-------|
| OCR07 | OCR06 | OCR05 | OCR04 | OCR03 | OCR02 | OCR01 | OCR00 |

OCR1 (Address 0B_H) Offset Calibration Coefficient (Middle Byte)

Reset Value = 00_H

| bit 7 | bit 6 | bit 5 | bit 4 | bit 3 | bit 2 | bit 1 | bit 0 |
|-------|-------|-------|-------|-------|-------|-------|-------|
| OCR15 | OCR14 | OCR13 | OCR12 | OCR11 | OCR10 | OCR09 | OCR08 |

OCR2 (Address 0C_H) Offset Calibration Coefficient (Most Significant Byte)

Reset Value = 00_H

| bit 7 | bit 6 | bit 5 | bit 4 | bit 3 | bit 2 | bit 1 | bit 0 |
|-------|-------|-------|-------|-------|-------|-------|-------|
| OCR23 | OCR22 | OCR21 | OCR20 | OCR19 | OCR18 | OCR17 | OCR16 |

FSR0 (Address 0D_H) Full-Scale Register (Least Significant Byte)

Reset Value = 24_H

| bit 7 | bit 6 | bit 5 | bit 4 | bit 3 | bit 2 | bit 1 | bit 0 |
|-------|-------|-------|-------|-------|-------|-------|-------|
| FSR07 | FSR06 | FSR05 | FSR04 | FSR03 | FSR02 | FSR01 | FSR00 |

FSR1 (Address 0E_H) Full-Scale Register (Middle Byte)

Reset Value = 90_H

| bit 7 | bit 6 | bit 5 | bit 4 | bit 3 | bit 2 | bit 1 | bit 0 |
|-------|-------|-------|-------|-------|-------|-------|-------|
| FSR15 | FSR14 | FSR13 | FSR12 | FSR11 | FSR10 | FSR09 | FSR08 |

FSR2 (Address 0F_H) Full-Scale Register (Most Significant Byte)

Reset Value = 67_H

| bit 7 | bit 6 | bit 5 | bit 4 | bit 3 | bit 2 | bit 1 | bit 0 |
|-------|-------|-------|-------|-------|-------|-------|-------|
| FSR23 | FSR22 | FSR21 | FSR20 | FSR19 | FSR18 | FSR17 | FSR16 |

ADS1216 CONTROL

COMMAND DEFINITIONS

The commands listed below control the operation of the ADS1216. Some of the commands are stand-alone commands (e.g., RESET) while others require additional bytes (e.g., WREG requires command, count, and the data bytes). Op codes that output data require a minimum of four f_{OSC} cycles before the data is ready (e.g., RDATA).

Operands:

n = count (0 to 127)

r = register (0 to 15)

x = don't care

a = RAM bank address (0 to 7)

| COMMANDS | DESCRIPTION | COMMAND BYTE | 2ND COMMAND BYTE |
|----------|------------------------------|---------------------------------|--------------------------|
| RDATA | Read Data | 0000 0001 (01 _H) | — |
| RDATA C | Read Data Continuously | 0000 0011 (03 _H) | — |
| STOPC | Stop Read Data Continuously | 0000 1111 (0F _H) | — |
| RREG | Read from REG Bank "rrrr" | 0001 r r r r (1x _H) | xxxx_nnnn (# of reg-1) |
| RRAM | Read from RAM Bank "aaa" | 0010 0aaa (2x _H) | xnnn_nnnn (# of bytes-1) |
| CREG | Copy REGs to RAM Bank "aaa" | 0100 0aaa (4x _H) | — |
| CREGA | Copy REGS to all RAM Banks | 0100 1000 (48 _H) | — |
| WREG | Write to REG "rrrr" | 0101 r r r r (5x _H) | xxxx_nnnn (# of reg-1) |
| WRAM | Write to RAM Bank "aaa" | 0110 0aaa (6x _H) | xnnn_nnnn (# of bytes-1) |
| CRAM | Copy RAM Bank "aaa" to REG | 1100 0aaa (Cx _H) | — |
| CSRAMX | Calc RAM Bank "aaa" Checksum | 1101 0aaa (Dx _H) | — |
| CSARAMX | Calc all RAM Bank Checksum | 1101 1000 (D8 _H) | — |
| CSREG | Calc REG Checksum | 1101 1111 (DF _H) | — |
| CSRAM | Calc RAM Bank "aaa" Checksum | 1110 0aaa (Ex _H) | — |
| CSARAM | Calc all RAM Banks Checksum | 1110 1000 (E8 _H) | — |
| SELFCAL | Self Cal Offset and Gain | 1111 0000 (F0 _H) | — |
| SELFOCAL | Self Cal Offset | 1111 0001 (F1 _H) | — |
| SELFGCAL | Self Cal Gain | 1111 0010 (F2 _H) | — |
| YSOCAL | Sys Cal Offset | 1111 0011 (F3 _H) | — |
| YSGCAL | Sys Cal Gain | 1111 0100 (F4 _H) | — |
| DSYNC | Sync DRDY | 1111 1100 (FC _H) | — |
| SLEEP | Put in SLEEP Mode | 1111 1101 (FD _H) | — |
| RESET | Reset to Power-Up Values | 1111 1110 (FE _H) | — |

NOTE: (1) The data received by the A/D is always MSB First, the data out format is set by the BIT ORDER bit in ACR reg.

TABLE III. Command Summary.

RDATA Read Data

Description: Read a single data value from the Data Output Register (DOR) which is the most recent conversion result. This is a 24-bit value.

Operands: None

Bytes: 1

Encoding: 0000 0001

Data Transfer Sequence:

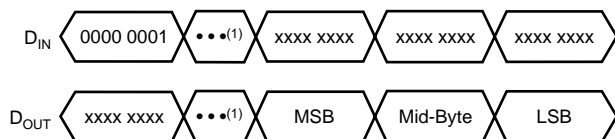

NOTE: (1) For wait time, refer to timing specification.

RDATA C Read Data Continuous

Description: Read Data Continuous mode enables the continuous output of new data on each \overline{DRDY} . This command eliminates the need to send the Read Data Command on each \overline{DRDY} . This mode may be terminated by either the STOPC Read Continuous command or the RESET command.

Operands: None

Bytes: 1

Encoding: 0000 0011

Data Transfer Sequence:

Command terminated when "uuuu uuuu" equals STOPC or RESET.

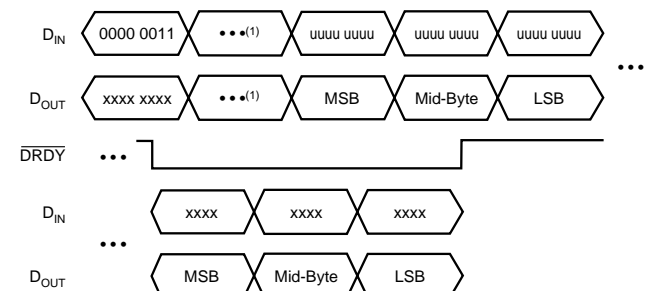

NOTE: (1) For wait time, refer to timing specification.

STOPC Stop Continuous

Description: Ends the continuous data output mode.

Operands: None

Bytes: 1

Encoding: 0000 1111

Data Transfer Sequence:

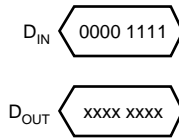

RREG Read from Registers

Description: Output the data from up to 16 registers starting with the register address specified as part of the instruction. The number of registers read will be one plus the second byte. If the count exceeds the remaining registers, the addresses will wrap back to the beginning.

Operands: r, n

Bytes: 2

Encoding: 0001 rrrr xxxx nnnn

Data Transfer Sequence:

Read Two Registers Starting from Register 01_H (MUX)



NOTE: (1) For wait time, refer to timing specification.

RRAM Read from RAM

Description: Up to 128 bytes can be read from RAM starting at the bank specified in the op code. All reads start at the address for the beginning of the RAM bank. The number of bytes to read will be one plus the value of the second byte.

Operands: a, n

Bytes: 2

Encoding: 0010 0aaa xnnn nnnn

Data Transfer Sequence:

Read Two RAM Locations Starting from 20_H



NOTE: (1) For wait time, refer to timing specification.

CREG Copy Registers to RAM Bank

Description: Copy the 16 control registers to the RAM bank specified in the op code. Refer to timing specifications for command execution time.

Operands: a

Bytes: 1

Encoding: 0100 0aaa

Data Transfer Sequence:

Copy Register Values to RAM Bank 3

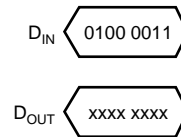

CREGA Copy Registers to All RAM Banks

Description: Duplicate the 16 control registers to all the RAM banks. Refer to timing specifications for command execution time.

Operands: None

Bytes: 1

Encoding: 0100 1000

Data Transfer Sequence:

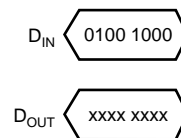

WREG Write to Register

Description: Write to the registers starting with the register specified as part of the instruction. The number of registers that will be written is one plus the value of the second byte.

Operands: r, n

Bytes: 2

Encoding: 0101 rrrr xxxx nnnn

Data Transfer Sequence:

Write Two Registers Starting from 06_H (DIO)

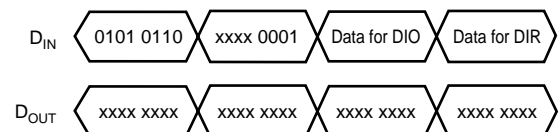

WRAM Write to RAM

Description: Write up to 128 RAM locations starting at the beginning of the RAM bank specified as part of the instruction. The number of bytes written to RAM is one plus the value of the second byte.

Operands: a, n

Bytes: 2

Encoding: 0110 0aaa xnnn nnnn

Data Transfer Sequence:

Write to Two RAM Locations starting from 10_H



CRAM Copy RAM Bank to Registers

Description: Copy the selected RAM Bank to the Configuration Registers. This will overwrite all of the registers with the data from the RAM bank.

Operands: a

Bytes: 1

Encoding: 1100 0aaa

Data Transfer Sequence:

Copy RAM Bank 0 to the Registers

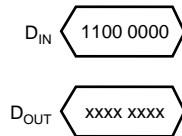

CSRAMX Calculate RAM Bank Checksum

Description: Calculate the checksum of the selected RAM Bank. The checksum is calculated as a sum of all the bytes with the carry ignored. The ID, \overline{DRDY} and DIO bits are masked so they are not included in the checksum.

Operands: a

Bytes: 1

Encoding: 1101 0aaa

Data Transfer Sequence:

Calculate Checksum for RAM Bank 3

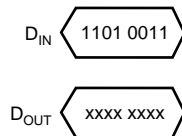

CSARAMX Calculate the Checksum for all RAM Banks

Description: Calculate the checksum of all RAM Banks. The checksum is calculated as a sum of all the bytes with the carry ignored. The ID, \overline{DRDY} and DIO bits are masked so they are not included in the checksum.

Operands: None

Bytes: 1

Encoding: 1101 1000

Data Transfer Sequence:

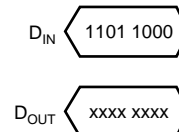

CSREG Calculate the Checksum of Registers

Description: Calculate the checksum of all the registers. The checksum is calculated as a sum of all the bytes with the carry ignored. The ID, \overline{DRDY} and DIO bits are masked so they are not included in the checksum.

Operands: None

Bytes: 1

Encoding: 1101 1111

Data Transfer Sequence:

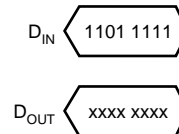

CSRAM Calculate RAM Bank Checksum

Description: Calculate the checksum of the selected RAM Bank. The checksum is calculated as a sum of all the bytes with the carry ignored. All bits are included in the checksum calculation, there is no masking of bits.

Operands: a

Bytes: 1

Encoding: 1110 0aaa

Data Transfer Sequence:

Calculate Checksum for RAM Bank 2

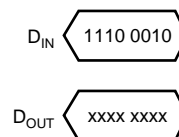

CSARAM Calculate Checksum for all RAM Banks

Description: Calculate the checksum of all RAM Banks. The checksum is calculated as a sum of all the bytes with the carry ignored. All bits are included in the checksum calculation, there is no masking of bits.

Operands: None

Bytes: 1

Encoding: 1110 1000

Data Transfer Sequence:

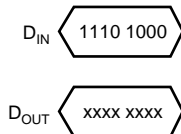

SELFCAL Offset and Gain Self Calibration

Description: Starts the process of self calibration. The Offset Control Register (OCR) and the Full-Scale Register (FSR) are updated with new values after this operation.

Operands: None

Bytes: 1

Encoding: 1111 0000

Data Transfer Sequence:

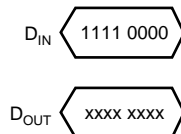

SELFOCAL Offset Self Calibration

Description: Starts the process of self-calibration for offset. The Offset Control Register (OCR) is updated after this operation.

Operands: None

Bytes: 1

Encoding: 1111 0001

Data Transfer Sequence:

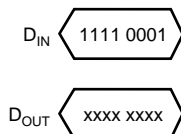

SELFGCAL Gain Self Calibration

Description: Starts the process of self-calibration for gain. The Full-Scale Register (FSR) is updated with new values after this operation.

Operands: None

Bytes: 1

Encoding: 1111 0010

Data Transfer Sequence:

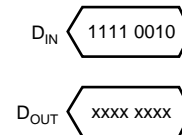

SYSOCAL System Offset Calibration

Description: Starts the system offset calibration process. For a system offset calibration the input should be set to 0V differential, and the ADS1216 computes the OCR register value that will compensate for offset errors. The Offset Control Register (OCR) is updated after this operation.

Operands: None

Bytes: 1

Encoding: 1111 0011

Data Transfer Sequence:

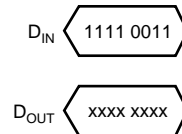

SYSGCAL System Gain Calibration

Description: Starts the system gain calibration process. For a system gain calibration, the differential input should be set to the reference voltage and the ADS1216 computes the FSR register value that will compensate for gain errors. The FSR is updated after this operation.

Operands: None

Bytes: 1

Encoding: 1111 0100

Data Transfer Sequence:

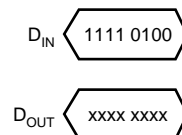

DSYNC Sync $\overline{\text{DRDY}}$

Description: Synchronizes the ADS1216 to the serial clock edge.

Operands: None

Bytes: 1

Encoding: 1111 1100

Data Transfer Sequence:

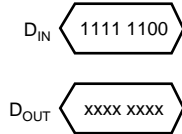

RESET Reset to Powerup Values

Description: Restore the registers to their power-up values. This command will also stop the Read Continuous mode. It does not affect the contents of RAM.

Operands: None

Bytes: 1

Encoding: 1111 1110

Data Transfer Sequence:

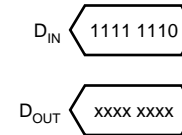

SLEEP Sleep Mode

Description: Puts the ADS1216 into a low power sleep mode. To exit sleep mode strobe SCLK.

Operands: None

Bytes: 1

Encoding: 1111 1101

Data Transfer Sequence:

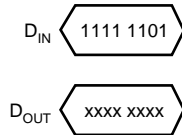

| MSB | LSB | | | | | | | | | | | | | | | |
|------|----------|-----------|-----------|----------|----------|----------|----------|----------|----------|--------|--------|--------|--------|--------|--------|--------|
| | 0000 | 0001 | 0010 | 0011 | 0100 | 0101 | 0110 | 0111 | 1000 | 1001 | 1010 | 1011 | 1100 | 1101 | 1110 | 1111 |
| 0000 | x | rdata | x | rdatac | x | x | x | x | x | x | x | x | x | x | x | stopc |
| 0001 | rreg 0 | rreg 1 | rreg 2 | rreg 3 | rreg 4 | rreg 5 | rreg 6 | rreg 7 | rreg 8 | rreg 9 | rreg A | rreg B | rreg C | rreg D | rreg E | rreg F |
| 0010 | rram 0 | rram 1 | rram 2 | rram 3 | rram 4 | rram 5 | rram 6 | rram 7 | x | x | x | x | x | x | x | x |
| 0011 | x | x | x | x | x | x | x | x | x | x | x | x | x | x | x | x |
| 0100 | creg 0 | creg 1 | creg 2 | creg 3 | creg 4 | creg 5 | creg 6 | creg 7 | crega | x | x | x | x | x | x | x |
| 0101 | wreg 0 | wreg 1 | wreg 2 | wreg 3 | wreg 4 | wreg 5 | wreg 6 | wreg 7 | wreg 8 | wreg 9 | wreg A | wreg B | wreg C | wreg D | wreg E | wreg F |
| 0110 | wram 0 | wram 1 | wram 2 | wram 3 | wram 4 | wram 5 | wram 6 | wram 7 | x | x | x | x | x | x | x | x |
| 0111 | x | x | x | x | x | x | x | x | x | x | x | x | x | x | x | x |
| 1000 | x | x | x | x | x | x | x | x | x | x | x | x | x | x | x | x |
| 1001 | x | x | x | x | x | x | x | x | x | x | x | x | x | x | x | x |
| 1010 | x | x | x | x | x | x | x | x | x | x | x | x | x | x | x | x |
| 1011 | x | x | x | x | x | x | x | x | x | x | x | x | x | x | x | x |
| 1100 | cram 0 | cram 1 | cram 2 | cram 3 | cram 4 | cram 5 | cram 6 | cram 7 | x | x | x | x | x | x | x | x |
| 1101 | csramx 0 | csramx 1 | csramx 2 | csramx 3 | csramx 4 | csramx 5 | csramx 6 | csramx 7 | csa ramx | x | x | x | x | x | x | csreg |
| 1110 | cs ram 0 | cs ram 1 | cs ram 2 | cs ram 3 | cs ram 4 | cs ram 5 | cs ram 6 | cs ram 7 | csa ram | x | x | x | x | x | x | x |
| 1111 | self cal | self ocal | self gcal | sys ocal | sys gcal | x | x | x | x | x | x | x | dsync | sleep | reset | x |

x = Reserved

TABLE IV. Command Map.

SERIAL PERIPHERAL INTERFACE

The Serial Peripheral Interface (SPI), allows a controller to communicate synchronously with the ADS1216. The ADS1216 operates in slave only mode.

SPI Transfer Formats

During an SPI transfer, data is simultaneously transmitted and received. The SCLK signal synchronizes shifting and sampling of the information on the two serial data lines: D_{IN} and D_{OUT} . The \overline{CS} signal allows individual selection of an ADS1216 device; an ADS1216 with \overline{CS} HIGH is not active on the bus.

Clock Phase and Polarity Controls (POL)

The clock polarity is specified by the POL pin, which selects an active HIGH or active LOW clock, and has no effect on the transfer format.

Serial Clock (SCLK)

SCLK, a Schmitt Trigger input to the ADS1216, is generated by the master device and synchronizes data transfer on the D_{IN} and D_{OUT} lines. When transferring data to or from the ADS1216, burst mode may be used i.e., multiple bits of data may be transferred back-to-back with no delay in SCLKs or toggling of \overline{CS} .

Chip Select (\overline{CS})

The chip select (\overline{CS}) input of the ADS1216 must be externally asserted before a master device can exchange data with the ADS1216. \overline{CS} must be LOW before data transactions and must stay LOW for the duration of the transaction.

DIGITAL INTERFACE

The ADS1216's programmable functions are controlled using a set of on-chip registers, as outlined previously. Data is written to these registers via the part's serial interface and read access to the on-chip registers is also provided by this interface.

The ADS1216's serial interface consists of four signals: \overline{CS} , SCLK, D_{IN} , and D_{OUT} . The D_{IN} line is used for transferring data into the on-chip registers while the D_{OUT} line is used for accessing data from the on-chip registers. SCLK is the serial clock input for the device and all data transfers (either on D_{IN} or D_{OUT}) take place with respect to this SCLK signal.

The \overline{DRDY} line is used as a status signal to indicate when data is ready to be read from the ADS1216's data register. \overline{DRDY} goes LOW when a new data word is available in the DOR register. It is reset HIGH when a read operation from the data register is complete. It also goes HIGH prior to the updating of the output register to indicate when not to read from the device to ensure that a data read is not attempted while the register is being updated.

\overline{CS} is used to select the device. It can be used to decode the ADS1216 in systems where a number of parts are connected to the serial bus.

The timing specification shows the timing diagram for interfacing to the ADS1216 with \overline{CS} used to decode the part.

The ADS1216 serial interface can operate in three-wire mode by tying the \overline{CS} input LOW. In this case, the SCLK, D_{IN} , and D_{OUT} lines are used to communicate with the ADS1216 and the status of \overline{DRDY} can be obtained by interrogating bit 7 of the M/DEC1 register. This scheme is suitable for interfacing to microcontrollers. If \overline{CS} is required as a decoding signal, it can be generated from a port pin.

DEFINITION OF TERMS

Analog Input Voltage—the voltage at any one analog input relative to AGND.

Analog Input Differential Voltage—given by the following equation: $(IN+ - IN-)$. Thus, a positive digital output is produced whenever the analog input differential voltage is positive, while a negative digital output is produced whenever the differential is negative.

For example, when the converter is configured with a 2.5V reference and placed in a gain setting of 1, the positive full-scale output is produced when the analog input differential is 2.5V. The negative full-scale output is produced when the differential is -2.5V. In each case, the actual input voltages must remain within the AGND to AV_{DD} range.

Conversion Cycle—the term “conversion cycle” usually refers to a discrete A/D conversion operation, such as that performed by a successive approximation converter. As used here, a conversion cycle refers to the t_{DATA} time period. However, each digital output is actually based on the modulator results from several t_{DATA} time periods.

| FILTER SETTING | MODULATOR RESULTS |
|-------------------|--------------------------|
| fast settling | 1 t_{DATA} time period |
| sinc ² | 2 t_{DATA} time period |
| sinc ³ | 3 t_{DATA} time period |

Data Rate—The rate at which conversions are completed. See definition for f_{DATA} .

Decimation Ratio—defines the ratio between the output of the modulator and the output Data Rate. Valid values for the Decimation Ratio are from 20 to 2047. Larger Decimation Ratios will have lower noise and vice-versa.

Effective Resolution—the effective resolution of the ADS1216 in a particular configuration can be expressed in two different units: bits rms (referenced to output) and V_{rms} (referenced to input). Computed directly from the converter’s output data, each is a statistical calculation. The conversion from one to the other is shown below.

“Effective number of bits” (ENOB) or “effective resolution” is commonly used to define the usable resolution of the A/D converter. It is calculated from empirical data taken directly from the device. It is typically determined by applying a fixed known signal source to the analog input and computing the standard deviation of the data sample set. The rms noise defines the $\pm\sigma$ interval about the sample mean (which implies that 95% of the data values fall within this range) and the peak-to-peak noise defines the $\pm 3\sigma$ interval about the sample mean (which implies that 99.6% of the data values fall within this range).

The data from the A/D converter is output as codes, which then can be easily converted to other units, such as ppm or volts. The equations and table below show the relationship between bits or codes, ppm, and volts.

$$ENOB = \frac{-20 \log(\text{ppm})}{6.02}$$

| BITS rms | BIPOLAR V_{rms} | UNIPOLAR V_{rms} |
|----------|---|---|
| | $\left(\frac{2 \cdot V_{REF}}{PGA} \right) \cdot 10^{\left(\frac{6.02 \cdot ER}{20} \right)}$ | $\left(\frac{V_{REF}}{PGA} \right) \cdot 10^{\left(\frac{6.02 \cdot ER}{20} \right)}$ |
| 24 | 298nV | 149nV |
| 22 | 1.19 μ V | 597nV |
| 20 | 4.77 μ V | 2.39 μ V |
| 18 | 19.1 μ V | 9.55 μ V |
| 16 | 76.4 μ V | 38.2 μ V |
| 14 | 505 μ V | 152.7 μ V |
| 12 | 1.22mV | 610 μ V |

Filter Selection—the ADS1216 uses a $(\sin x/x)$ filter or sinc filter. Actually there are three different sinc filters that can be selected. A fast settling filter will settle in one t_{DATA} cycle. The sinc^2 filter will settle in two cycles and have lower noise. The sinc^3 will achieve lowest noise and higher number of effective bits, but requires three cycles to settle. The ADS1216 will operate with any one of these filters, or it can operate in an auto mode, where it will select the fast settling filter after a new channel is selected and will then switch to sinc^2 followed by sinc^3 . This allows fast settling response and still achieves low noise after the necessary number of t_{DATA} cycles.

f_{OSC} —the frequency of the crystal oscillator or CMOS compatible input signal at the X_{IN} input of the ADS1216.

f_{MOD} —the frequency or speed at which the modulator of the ADS1216 is running. This depends on the SPEED bit as given by the following equation:

| | SPEED = 0 | SPEED = 1 |
|---------|-----------|-----------|
| mfactor | 128 | 256 |

$$f_{MOD} = \frac{f_{OSC}}{\text{mfactor}}$$

f_{SAMP} —the frequency, or switching speed, of the input sampling capacitor. The value is given by one of the following equations:

| PGA SETTING | SAMPLING FREQUENCY |
|-------------|---|
| 1, 2, 4, 8 | $f_{SAMP} = \frac{f_{OSC}}{\text{mfactor}}$ |
| 16 | $f_{SAMP} = \frac{f_{OSC} \cdot 2}{\text{mfactor}}$ |
| 32 | $f_{SAMP} = \frac{f_{OSC} \cdot 4}{\text{mfactor}}$ |
| 64, 128 | $f_{SAMP} = \frac{f_{OSC} \cdot 8}{\text{mfactor}}$ |

f_{DATA} —the frequency of the digital output data produced by the ADS1216, f_{DATA} is also referred to as the Data Rate.

$$f_{DATA} = \left(\frac{f_{MOD}}{\text{Decimation Ratio}} \right) = \left(\frac{f_{OSC}}{\text{mfactor} \cdot \text{Decimation Ratio}} \right)$$

Full-Scale Range (FSR)—as with most A/D converters, the full-scale range of the ADS1216 is defined as the “input”, which produces the positive full-scale digital output minus the “input”, which produces the negative full-scale digital output. The full-scale range changes with gain setting as shown in Table V.

For example, when the converter is configured with a 2.5V reference and is placed in a gain setting of 2, the full-scale range is: [1.25V (positive full-scale) minus -1.25 V (negative full-scale)] = 2.5V.

Least Significant Bit (LSB) Weight—this is the theoretical amount of voltage that the differential voltage at the analog input would have to change in order to observe a change in the output data of one least significant bit. It is computed as follows:

$$\text{LSB Weight} = \frac{\text{Full-Scale Range}}{2^N}$$

where N is the number of bits in the digital output.

t_{DATA} —the inverse of f_{DATA} , or the period between each data output.

| GAIN SETTING | 5V SUPPLY ANALOG INPUT ⁽¹⁾ | | | GENERAL EQUATIONS | | |
|--------------|---------------------------------------|--|------------------|-------------------------------|--|-----------------------------------|
| | FULL-SCALE RANGE | DIFFERENTIAL INPUT VOLTAGES ⁽²⁾ | PGA OFFSET RANGE | FULL-SCALE RANGE | DIFFERENTIAL INPUT VOLTAGES ⁽²⁾ | PGA SHIFT RANGE |
| 1 | 5V | ±2.5V | ±1.25V | $\frac{2 \cdot V_{REF}}{PGA}$ | $\frac{\pm V_{REF}}{PGA}$ | $\frac{\pm V_{REF}}{2 \cdot PGA}$ |
| 2 | 2.5V | ±1.25V | ±0.625V | | | |
| 4 | 1.25V | ±0.625V | ±312.5mV | | | |
| 8 | 0.625V | ±312.5mV | ±156.25mV | | | |
| 16 | 312.5mV | ±156.25mV | ±78.125mV | | | |
| 32 | 156.25mV | ±78.125mV | ±39.0625mV | | | |
| 64 | 78.125mV | ±39.0625mV | ±19.531mV | | | |
| 128 | 39.0625mV | ±19.531mV | ±9.766mV | | | |

NOTES: (1) With a 2.5V reference. (2) The ADS1216 allows common-mode voltage as long as the absolute input voltage on A_{INP} or A_{INN} does not go below AGND or above AV_{DD}.

TABLE V. Full-Scale Range versus PGA Setting.

TOPIC INDEX

| TOPIC | PAGE |
|--|-------|
| ABSOLUTE MAXIMUM RATINGS | 2 |
| PACKAGE/ORDERING INFORMATION | 2 |
| ELECTRICAL CHARACTERISTICS ($V_{DD} = 5V$) | 2-3 |
| ELECTRICAL CHARACTERISTICS ($V_{DD} = 3V$) | 4-5 |
| PIN CONFIGURATION | 6 |
| TIMING CHARACTERISTICS | 7 |
| TYPICAL CHARACTERISTICS | 8-11 |
| OVERVIEW | 12 |
| MEMORY | 14 |
| ADS1216 REGISTER BANK TOPOLOGY | 15 |
| DETAILED REGISTER DEFINITIONS | 16-17 |
| COMMAND DEFINITIONS | 18-22 |
| ADS1216 COMMAND MAP | 22 |
| SERIAL PERIPHERAL INTERFACE | 23 |
| DIGITAL INTERFACE | 23 |
| DEFINITION OF TERMS | 23-24 |

MECHANICAL DATA

MTQF019A – JANUARY 1995 – REVISED JANUARY 1998

PFB (S-PQFP-G48)

PLASTIC QUAD FLATPACK

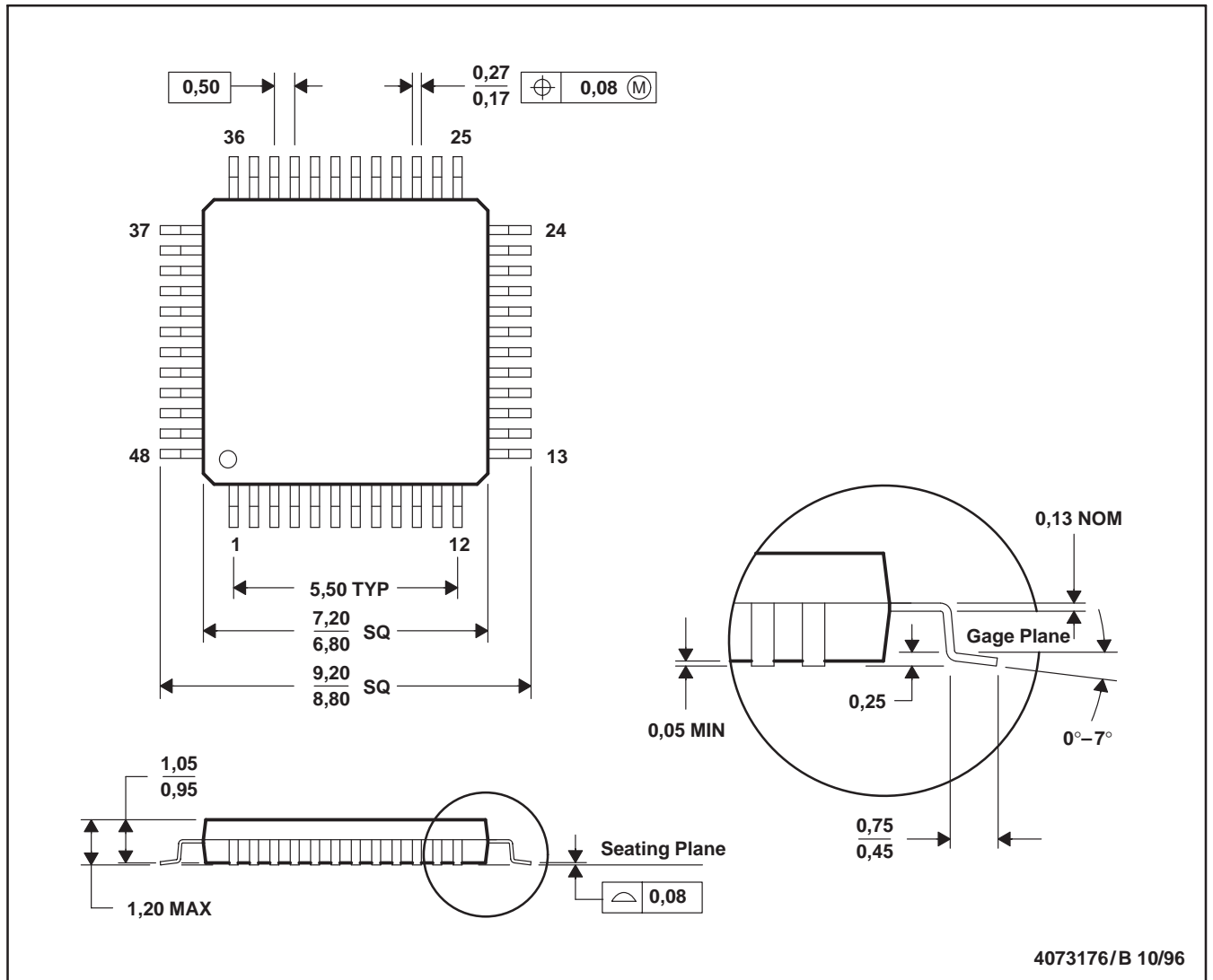

- NOTES: A. All linear dimensions are in millimeters.
 B. This drawing is subject to change without notice.
 C. Falls within JEDEC MS-026

IMPORTANT NOTICE

Texas Instruments Incorporated and its subsidiaries (TI) reserve the right to make corrections, modifications, enhancements, improvements, and other changes to its products and services at any time and to discontinue any product or service without notice. Customers should obtain the latest relevant information before placing orders and should verify that such information is current and complete. All products are sold subject to TI's terms and conditions of sale supplied at the time of order acknowledgment.

TI warrants performance of its hardware products to the specifications applicable at the time of sale in accordance with TI's standard warranty. Testing and other quality control techniques are used to the extent TI deems necessary to support this warranty. Except where mandated by government requirements, testing of all parameters of each product is not necessarily performed.

TI assumes no liability for applications assistance or customer product design. Customers are responsible for their products and applications using TI components. To minimize the risks associated with customer products and applications, customers should provide adequate design and operating safeguards.

TI does not warrant or represent that any license, either express or implied, is granted under any TI patent right, copyright, mask work right, or other TI intellectual property right relating to any combination, machine, or process in which TI products or services are used. Information published by TI regarding third-party products or services does not constitute a license from TI to use such products or services or a warranty or endorsement thereof. Use of such information may require a license from a third party under the patents or other intellectual property of the third party, or a license from TI under the patents or other intellectual property of TI.

Reproduction of information in TI data books or data sheets is permissible only if reproduction is without alteration and is accompanied by all associated warranties, conditions, limitations, and notices. Reproduction of this information with alteration is an unfair and deceptive business practice. TI is not responsible or liable for such altered documentation.

Resale of TI products or services with statements different from or beyond the parameters stated by TI for that product or service voids all express and any implied warranties for the associated TI product or service and is an unfair and deceptive business practice. TI is not responsible or liable for any such statements.

Following are URLs where you can obtain information on other Texas Instruments products and application solutions:

| Products | | Applications | |
|------------------|--|---------------------|--|
| Amplifiers | amplifier.ti.com | Audio | www.ti.com/audio |
| Data Converters | dataconverter.ti.com | Automotive | www.ti.com/automotive |
| DSP | dsp.ti.com | Broadband | www.ti.com/broadband |
| Interface | interface.ti.com | Digital Control | www.ti.com/digitalcontrol |
| Logic | logic.ti.com | Military | www.ti.com/military |
| Power Mgmt | power.ti.com | Optical Networking | www.ti.com/opticalnetwork |
| Microcontrollers | microcontroller.ti.com | Security | www.ti.com/security |
| | | Telephony | www.ti.com/telephony |
| | | Video & Imaging | www.ti.com/video |
| | | Wireless | www.ti.com/wireless |

Mailing Address: Texas Instruments
Post Office Box 655303 Dallas, Texas 75265