



Low Noise Amplifier 1.575 GHz

AM50-0002

V 2.00

Features

- Low Noise Figure: 1.15 dB
- High Gain: 27 dB
- Low Power Consumption: 3 to 5 V, 20 mA
- High Dynamic Range
- Low Cost SOIC 8 Plastic Package

Description

M/A-COM's AM50-0002 is a high performance GaAs MMIC low noise amplifier in a low cost SOIC 8-lead surface mount plastic package. The AM50-0002 employs a monolithic 3-stage self-bias design and a simple external matching network to obtain minimum noise figure. It can be biased using 3- or 5-volt supplies.

The AM50-0002 is ideally suited for use where low noise figure, high gain, high dynamic range and low power consumption are required. Typical applications include receiver front ends in the Global Positioning System (GPS) market, as well as standard gain blocks, buffer amps, driver amps and IF amps in both fixed and portable systems.

M/A-COM's AM50-0002 is fabricated using a mature 0.5-micron gate length GaAs process. The process features full passivation for increased performance reliability.

Electrical Specifications¹

$T_A = +25^\circ\text{C}$, $Z_0 = 50$, $V_{DD} = +5\text{V}$, $P_{IN} = -35\text{ dBm}$, $f = 1.575\text{ GHz}$

Parameter	Units	Min.	Typ.	Max.
Gain	dB	25	27	29
Noise Figure	dB		1.15	1.4
Input VSWR			2.0:1	
Output VSWR			1.5:1	
Output 1 dB Compression	dBm		1	
Input IP_3	dBm		-14	
Reverse Isolation	dB		48	
Bias Current	mA	15	20	25

1. See following pages for 3-volt data.

SO-8

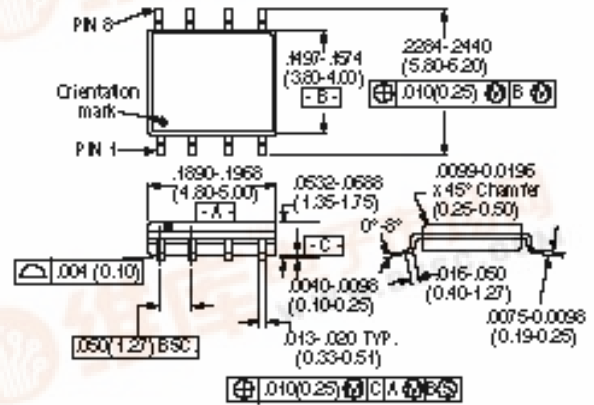

8-Lead SOP outline dimensions
Narrow body .150
(All dimensions per JEDEC No. MS-012-AA, Issue C)
Dimensions in () are in mm.
Unless Otherwise Noted: xxx = ± 0.010 (xxx = ± 0.25)
xxx = ± 0.02 (x = ± 0.5)

Ordering Information

Part Number	Package
AM50-0002	SOIC 8-Lead Plastic
AM50-0002TR	Forward Tape and Reel*
AM50-0002RTR	Reverse Tape and Reel*
AM50-0002SMB	Designer's Kit

* If specific reel size is required, consult factory for part number assignment.



Absolute Maximum Ratings¹

Parameter	Absolute Maximum
V _{DD}	+10 VDC
Input Power	+17 dBm
Channel Temperature ²	+150°C
Operating Temperature	-40°C to 85°C
Storage Temperature	-65°C to 150°C

1. Operation of this device outside these limits may cause permanent damage.
2. Typical thermal resistance (θ_{jc}) = +165°C/W

Functional Diagram

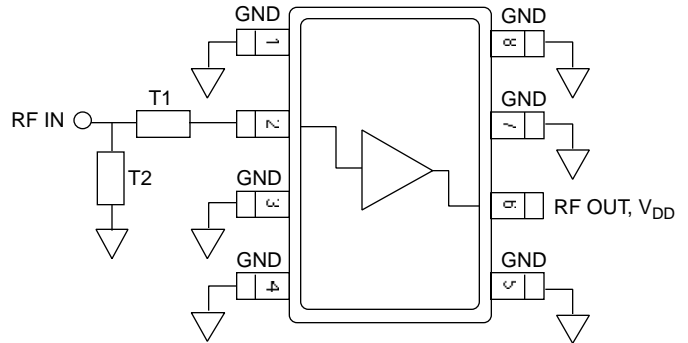

Recommended PCB Configuration

Dimensions in inches (mm)

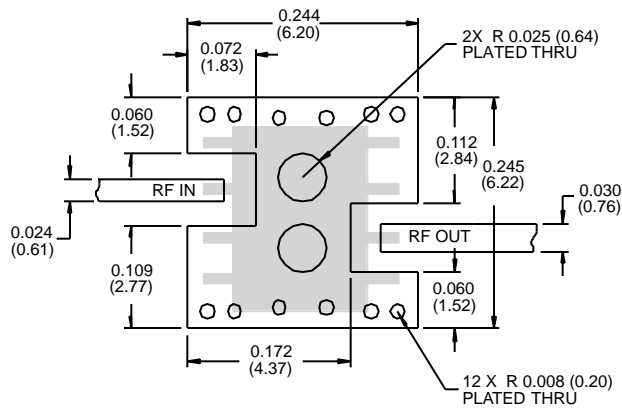

FR-4 circuit board, thickness = 0.016 inches (0.41)

	Frequency = 1.575 GHz	
	Impedance	Electrical Length
T1	57.2	36.0°
T2	82.7	16.2°

3. Pins 1, 3, 4, 5, 7 and 8 must be RF and DC grounded as shown.
4. Pin 2 is the RF input and must be connected to the simple matching network shown.
5. Pin 6 is the RF output. V_{DD} is also applied on pin 6.

Typical Performance

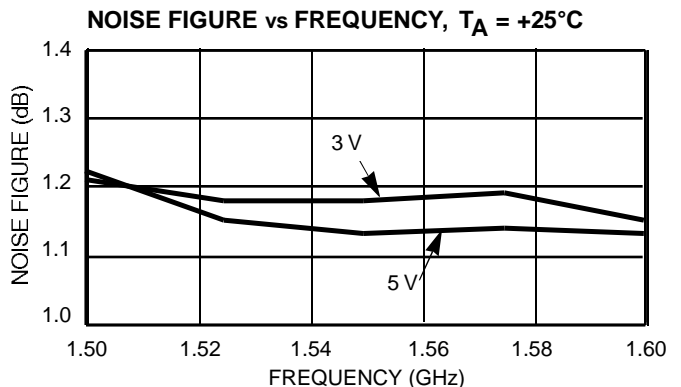
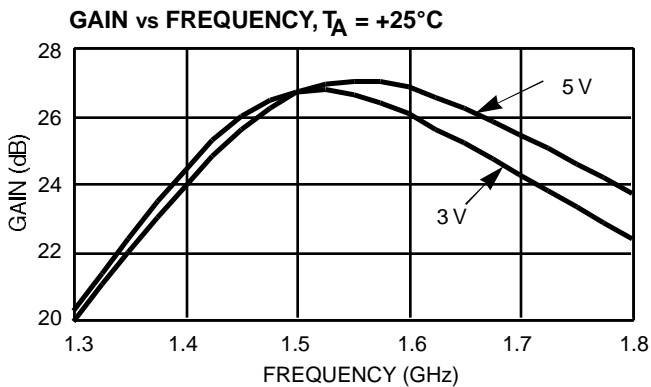

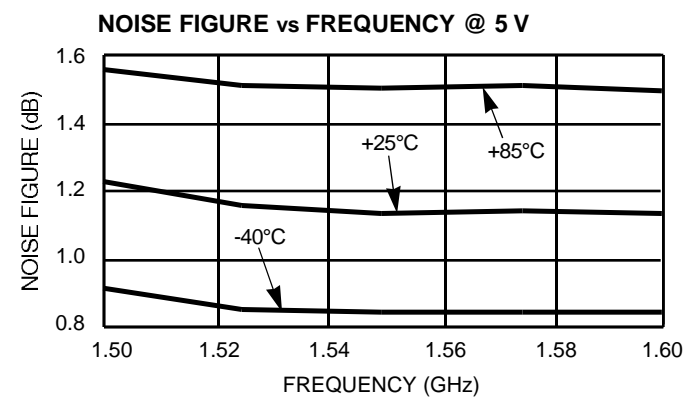
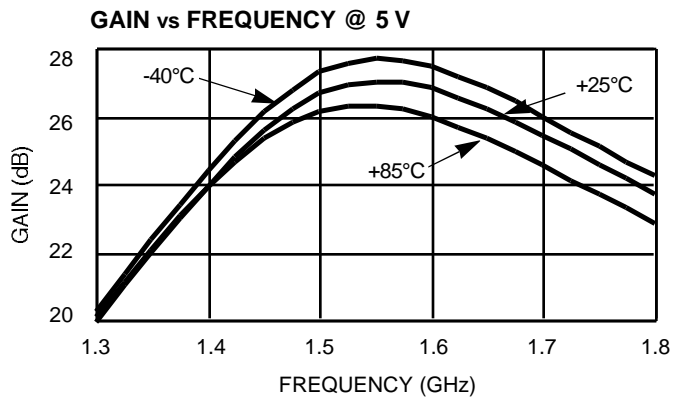
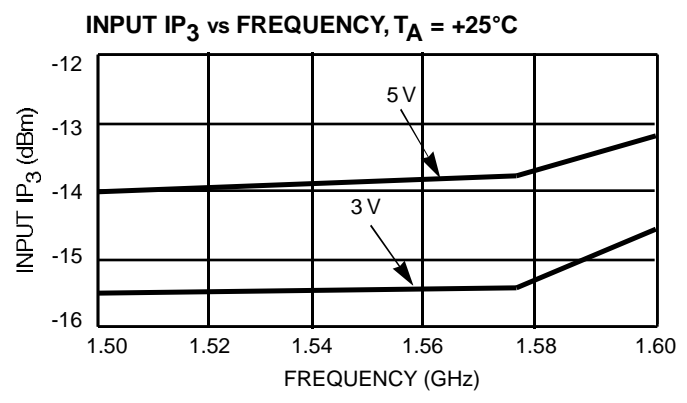
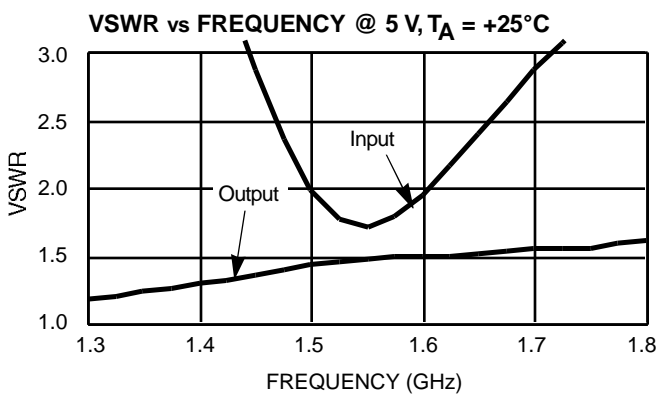

Additional information is available in Application Note M540, "M/A-COM GaAs MMIC LNA SOIC-8 Platform."