

DISCRETE SEMICONDUCTORS

DATA SHEET

BLF177 HF/VHF power MOS transistor

Product specification
File under Discrete Semiconductors, SC08a

September 1992

HF/VHF power MOS transistor

BLF177

FEATURES

- High power gain
- Low intermodulation distortion
- Easy power control
- Good thermal stability
- Withstands full load mismatch.

DESCRIPTION

Silicon N-channel enhancement mode vertical D-MOS transistor designed for industrial and military applications in the HF/VHF frequency range.

The transistor is encapsulated in a 4-lead, SOT121 flange envelope, with a ceramic cap. All leads are isolated from the flange.

A marking code, showing gate-source voltage (V_{GS}) information is provided for matched pair applications. Refer to the 'General' section for further information.

PIN CONFIGURATION

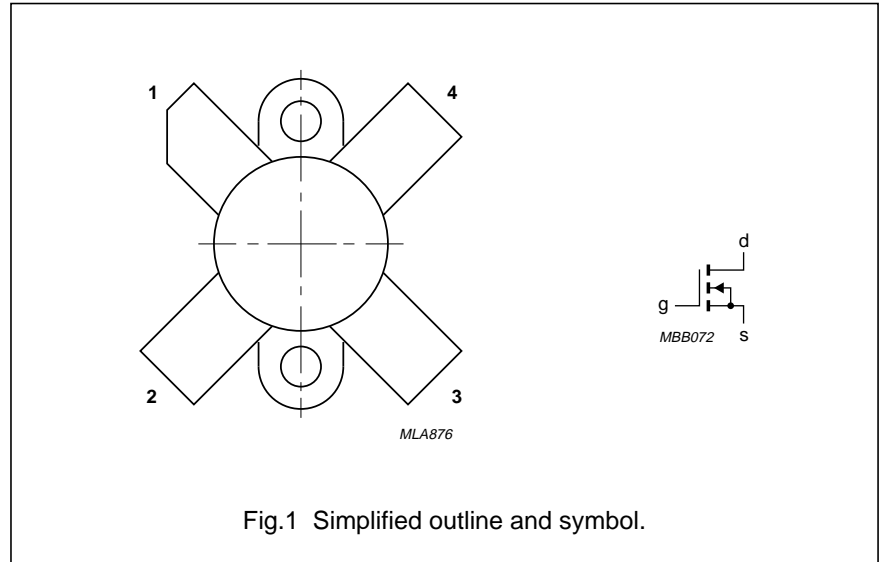

Fig.1 Simplified outline and symbol.

CAUTION

The device is supplied in an antistatic package. The gate-source input must be protected against static charge during transport and handling.

WARNING

Product and environmental safety - toxic materials

This product contains beryllium oxide. The product is entirely safe provided that the BeO disc is not damaged. All persons who handle, use or dispose of this product should be aware of its nature and of the necessary safety precautions. After use, dispose of as chemical or special waste according to the regulations applying at the location of the user. It must never be thrown out with the general or domestic waste.

PINNING - SOT121

PIN	DESCRIPTION
1	drain
2	source
3	gate
4	source

QUICK REFERENCE DATA

RF performance at $T_h = 25\text{ }^\circ\text{C}$ in a common source test circuit.

MODE OF OPERATION	f (MHz)	V_{DS} (V)	P_L (W)	G_p (dB)	η_D (%)	d_3 (dB)	d_5 (dB)
SSB class-AB	28	50	150 (PEP)	> 20	> 35	< -30	< -30
CW class-B	108	50	150	typ. 19	typ. 70	-	-

HF/VHF power MOS transistor

BLF177

LIMITING VALUES

In accordance with the Absolute Maximum System (IEC 134).

SYMBOL	PARAMETER	CONDITIONS	MIN.	MAX.	UNIT
V_{DS}	drain-source voltage		–	110	V
$\pm V_{GS}$	gate-source voltage		–	20	V
I_D	DC drain current		–	16	A
P_{tot}	total power dissipation	up to $T_{mb} = 25\text{ }^\circ\text{C}$	–	220	W
T_{stg}	storage temperature		–65	150	$^\circ\text{C}$
T_j	junction temperature		–	200	$^\circ\text{C}$

THERMAL RESISTANCE

SYMBOL	PARAMETER	THERMAL RESISTANCE
$R_{th\ j-mb}$	thermal resistance from junction to mounting base	max. 0.8 K/W
$R_{th\ mb-h}$	thermal resistance from mounting base to heatsink	max. 0.2 K/W

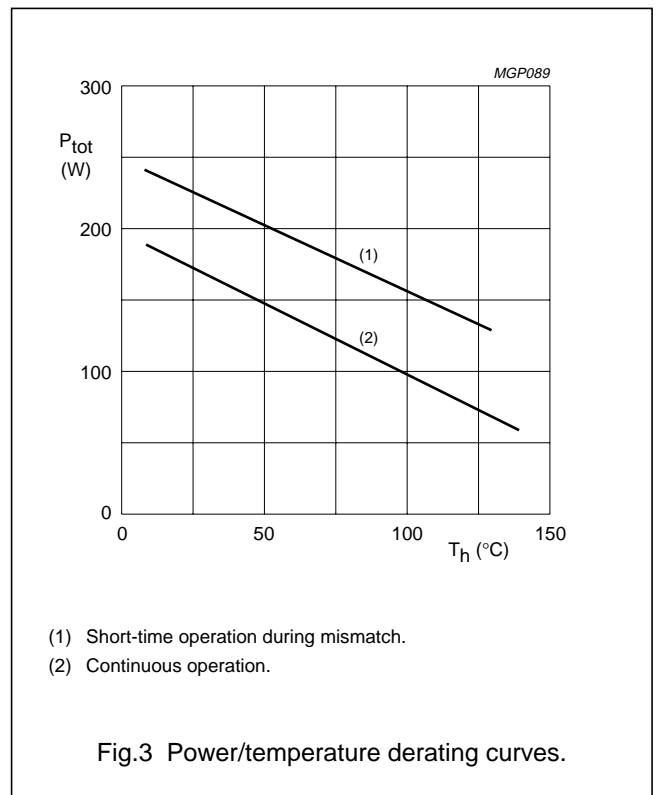
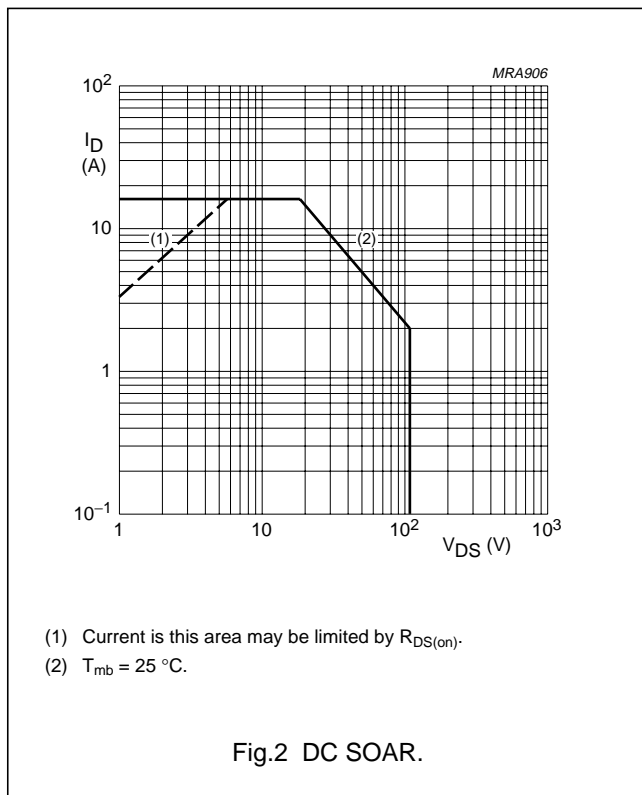

HF/VHF power MOS transistor

BLF177

CHARACTERISTICS

$T_j = 25\text{ }^\circ\text{C}$ unless otherwise specified.

SYMBOL	PARAMETER	CONDITIONS	MIN.	TYP.	MAX.	UNIT
$V_{(BR)DSS}$	drain-source breakdown voltage	$I_D = 50\text{ mA}; V_{GS} = 0$	110	–	–	V
I_{DSS}	drain-source leakage current	$V_{GS} = 0; V_{DS} = 50\text{ V}$	–	–	2.5	mA
I_{GSS}	gate-source leakage current	$\pm V_{GS} = 20\text{ V}; V_{DS} = 0$	–	–	1	μA
$V_{GS(th)}$	gate-source threshold voltage	$I_D = 50\text{ mA}; V_{DS} = 10\text{ V}$	2	–	4.5	V
ΔV_{GS}	gate-source voltage difference of matched pairs	$I_D = 50\text{ mA}; V_{DS} = 10\text{ V}$	–	–	100	mV
g_{fs}	forward transconductance	$I_D = 5\text{ A}; V_{DS} = 10\text{ V}$	4.5	6.2	–	S
$R_{DS(on)}$	drain-source on-state resistance	$I_D = 5\text{ A}; V_{GS} = 10\text{ V}$	–	0.2	0.3	Ω
I_{DSX}	on-state drain current	$V_{GS} = 10\text{ V}; V_{DS} = 10\text{ V}$	–	25	–	A
C_{is}	input capacitance	$V_{GS} = 0; V_{DS} = 50\text{ V}; f = 1\text{ MHz}$	–	480	–	pF
C_{os}	output capacitance	$V_{GS} = 0; V_{DS} = 50\text{ V}; f = 1\text{ MHz}$	–	190	–	pF
C_{rs}	feedback capacitance	$V_{GS} = 0; V_{DS} = 50\text{ V}; f = 1\text{ MHz}$	–	14	–	pF

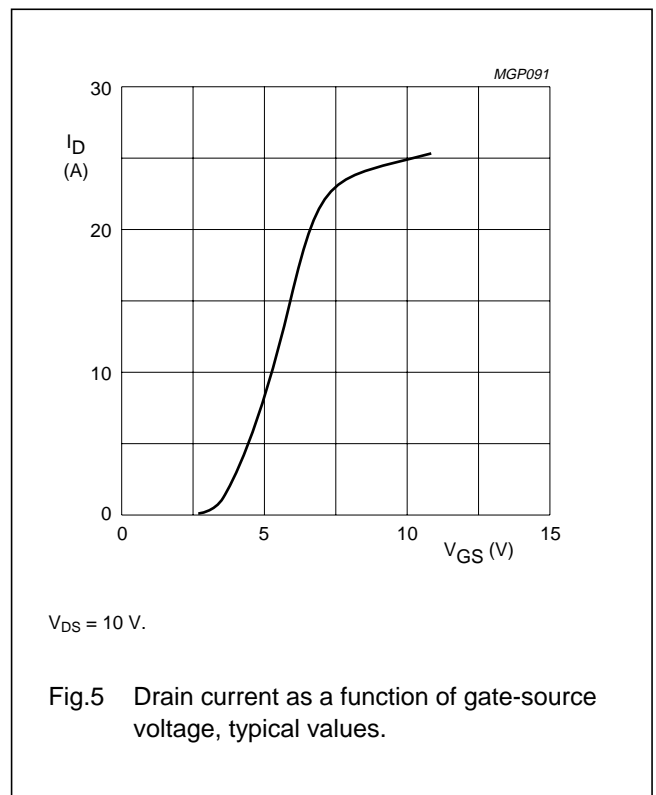
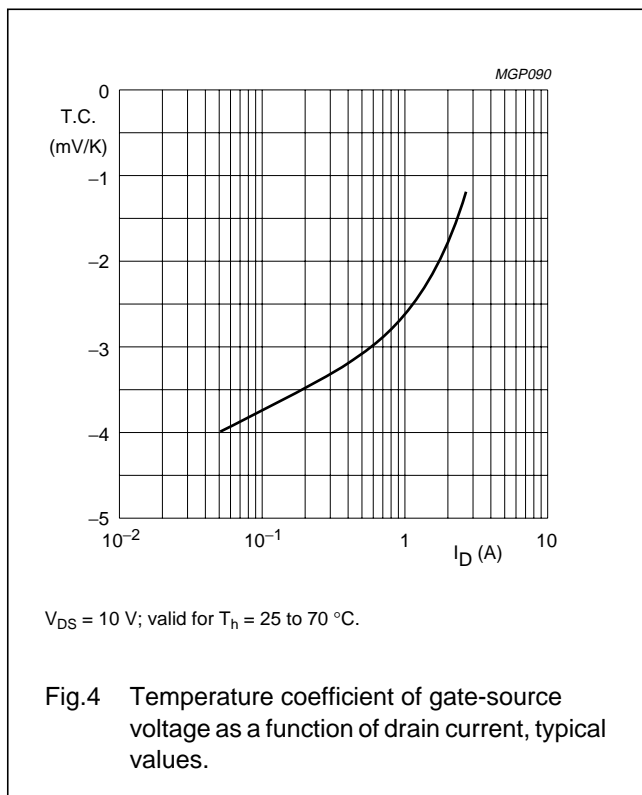

HF/VHF power MOS transistor

BLF177

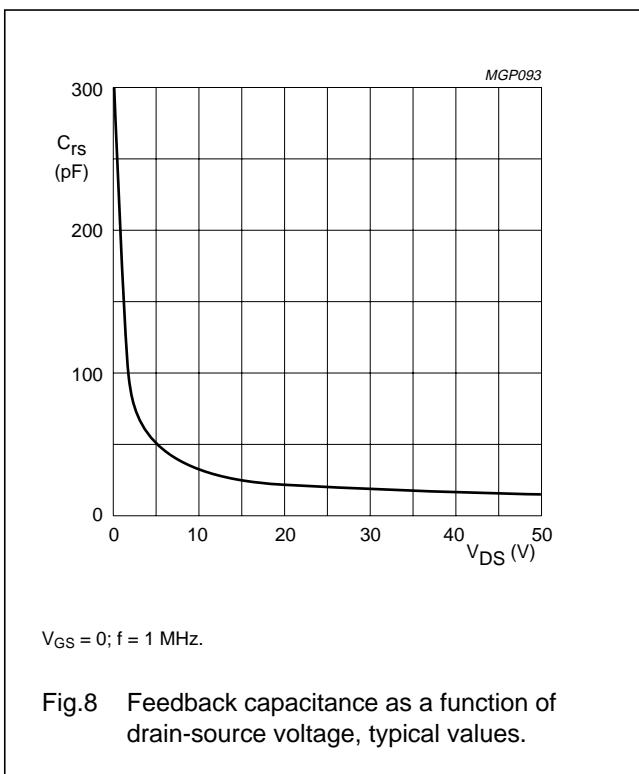
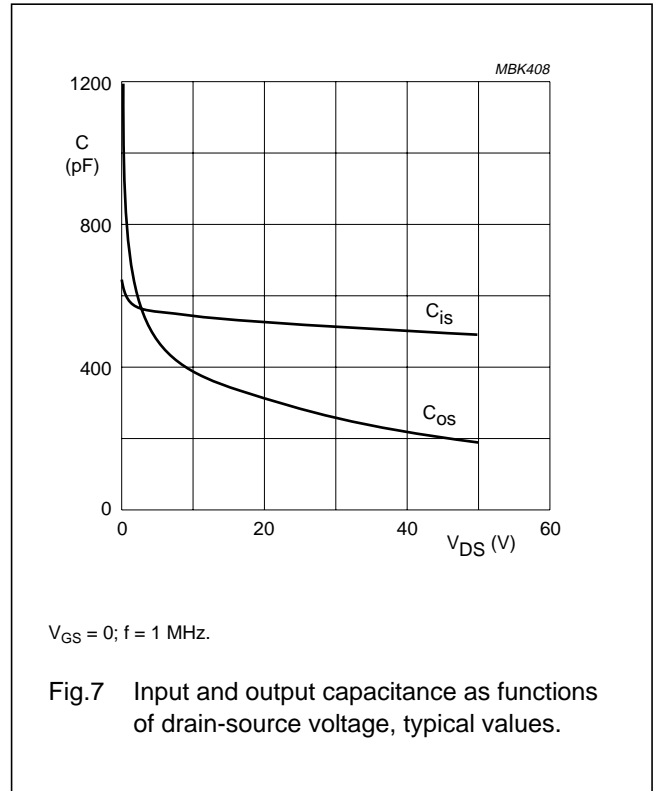
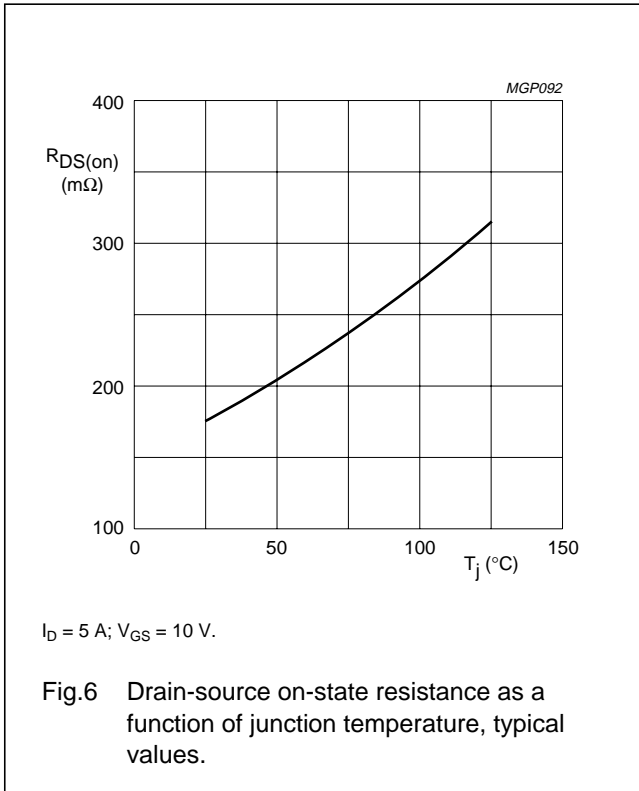

HF/VHF power MOS transistor

BLF177

APPLICATION INFORMATION FOR CLASS-AB OPERATION

$T_h = 25\text{ }^\circ\text{C}$; $R_{th\text{ mb-h}} = 0.2\text{ K/W}$; $Z_L = 6.25 + j0\ \Omega$ unless otherwise specified.

RF performance in SSB operation in a common source class-AB circuit.

$f_1 = 28.000\text{ MHz}$; $f_2 = 28.001\text{ MHz}$.

MODE OF OPERATION	f (MHz)	V _{DS} (V)	I _{DQ} (A)	P _L (W)	G _p (dB)	η_D (%)	d ₃ (dB) (note 1)	d ₅ (dB) (note 1)
SSB, class-AB	28	50	0.7	20 to 150 (PEP)	> 20 typ. 35	> 35 typ. 40	< -30 typ. -35	< -30 typ. -38

Note

1. Stated figures are maximum values encountered at any driving level between the specified value of PEP and are referred to the according level of either the equal amplified tones. Related to the according peak envelope power these figures should be decreased by 6 dB.

Ruggedness in class-AB operation

The BLF177 is capable of withstanding a load mismatch corresponding to VSWR = 50 through all phases under the following conditions:

V_{DS} = 50 V; f = 28 MHz at rated output power.

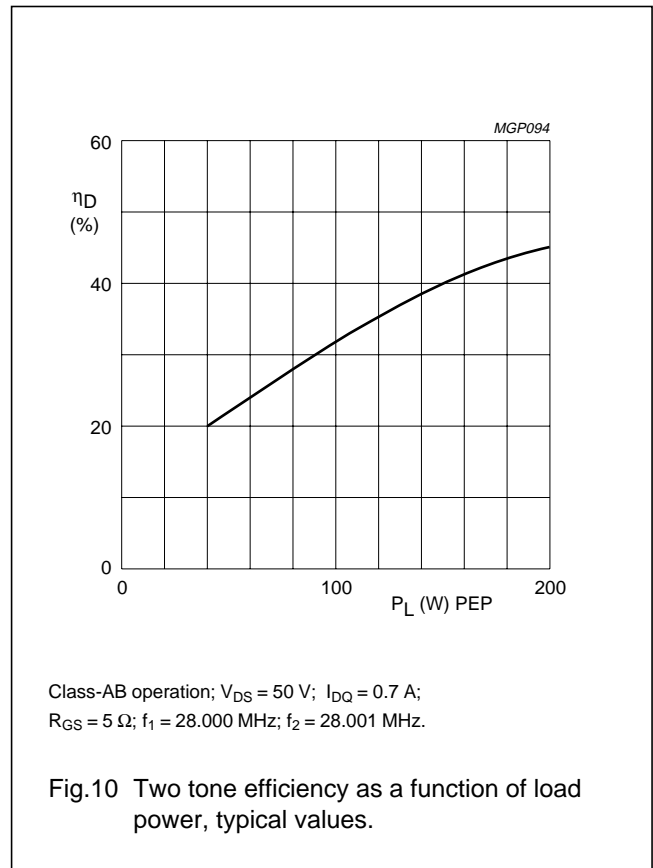
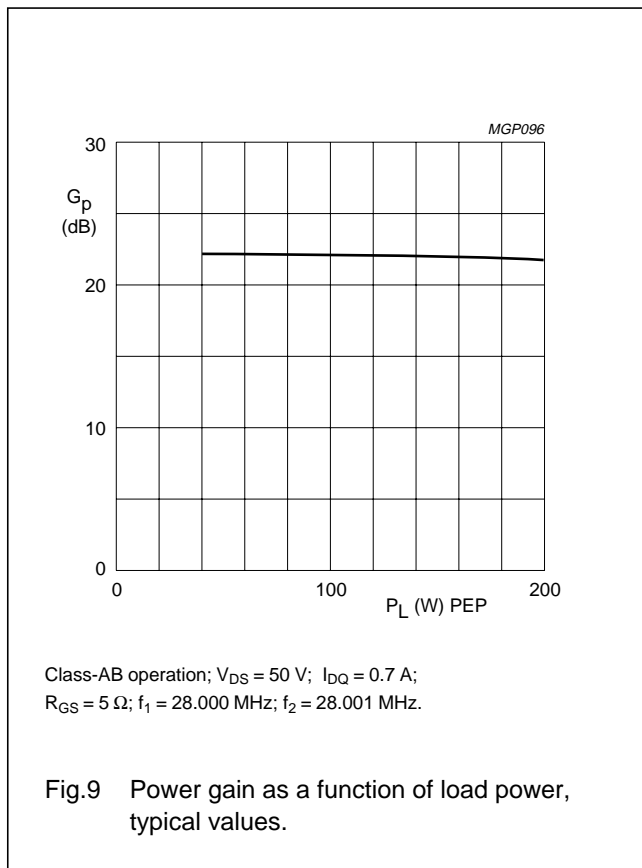

HF/VHF power MOS transistor

BLF177

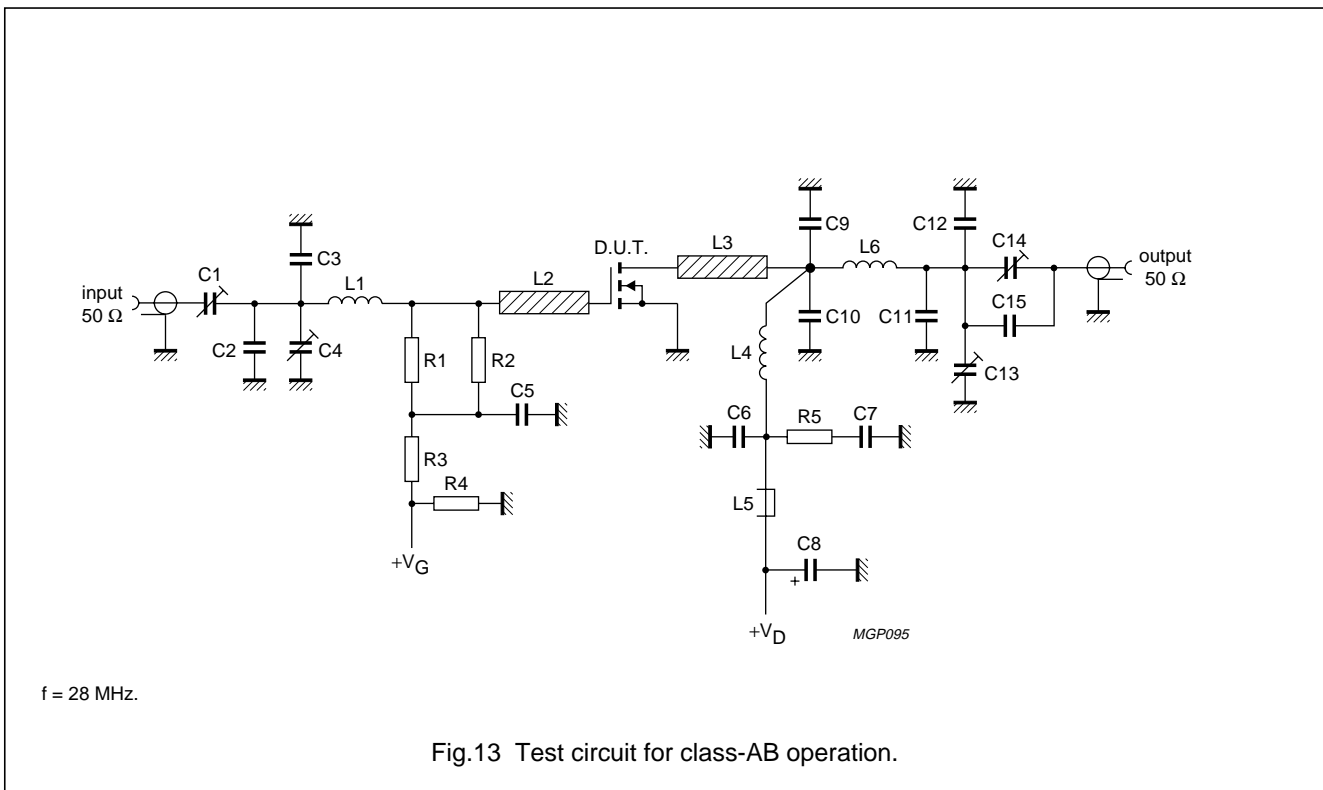
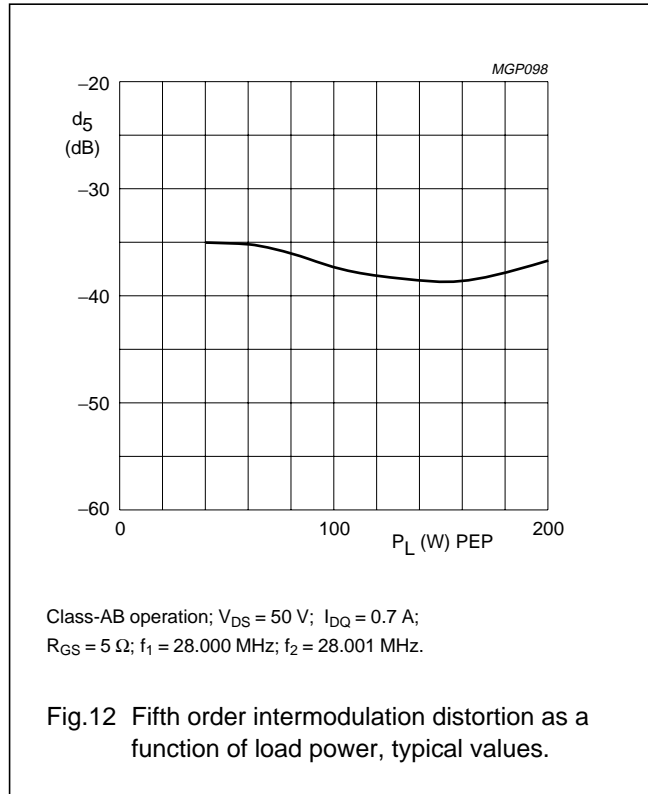
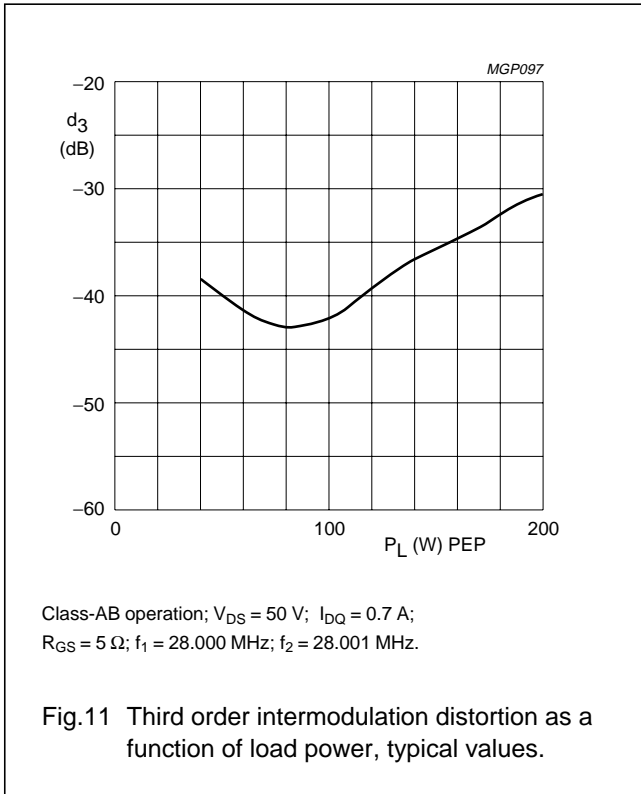

HF/VHF power MOS transistor

BLF177

List of components (class-AB test circuit)

COMPONENT	DESCRIPTION	VALUE	DIMENSIONS	CATALOGUE NO.
C1, C4, C13, C14	film dielectric trimmer	7 to 100 pF		2222 809 07015
C2	multilayer ceramic chip capacitor (note 1)	56 pF		
C3, C11	multilayer ceramic chip capacitor (note 1)	62 pF		
C5, C6	multilayer ceramic chip capacitor	100 nF		2222 852 47104
C7	multilayer ceramic chip capacitor	3 × 100 nF		2222 852 47104
C5	multilayer ceramic chip capacitor	10 nF		2222 852 47103
C7	multilayer ceramic chip capacitor	3 × 100 nF		2222 852 47104
C8	electrolytic capacitor	2.2 μF, 63 V		
C9, C10	multilayer ceramic chip capacitor (note 1)	20 pF		
C12	multilayer ceramic chip capacitor (note 1)	100 pF		
C15	multilayer ceramic chip capacitor (note 1)	150 pF		
L1	5 turns enamelled 0.7 mm copper wire	133 nH	length 4.5 mm; int. dia. 6 mm; leads 2 × 5 mm	
L2, L3	stripline (note 2)	41.1 Ω	length 13 × 6 mm	
L4	7 turns enamelled 1.5 mm copper wire	236 nH	length 12.5 mm; int. dia. 8 mm; leads 2 × 5 mm	
L5	grade 3B Ferroxcube wideband HF choke			4312 020 36642
L6	5 turns enamelled 2 mm copper wire	170 nH	length 11.5 mm; int. dia. 8 mm; leads 2 × 5 mm	
R1, R2	1 W metal film resistor	10 Ω		
R2	0.4 W metal film resistor	10 kΩ		
R3	0.4 W metal film resistor	1 MΩ		
R5	1 W metal film resistor	10 kΩ		

Notes

- American Technical Ceramics (ATC) capacitor, type 100B or other capacitor of the same quality.
- The striplines are on a double copper-clad printed circuit board, with PTFE fibre-glass dielectric ($\epsilon_r = 2.2$), thickness 1.6 mm.

HF/VHF power MOS transistor

BLF177

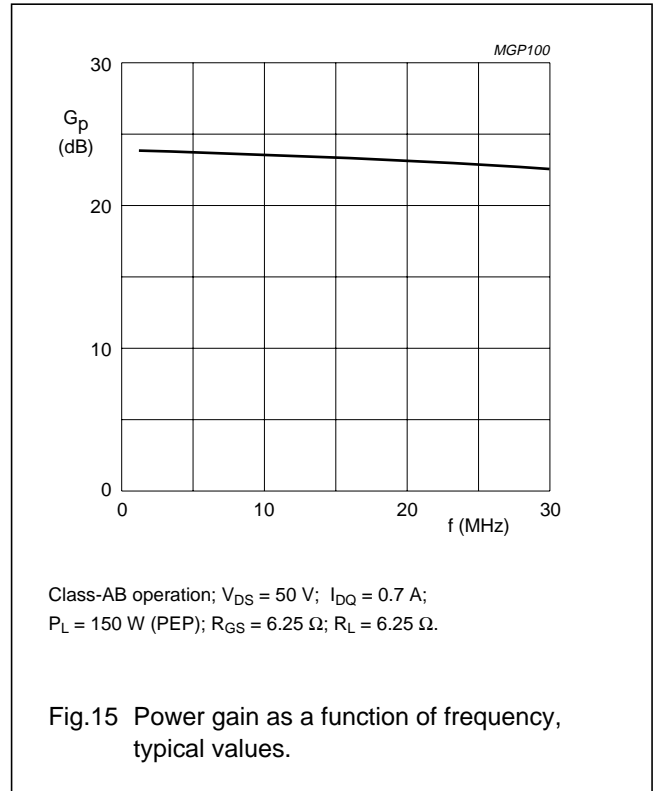
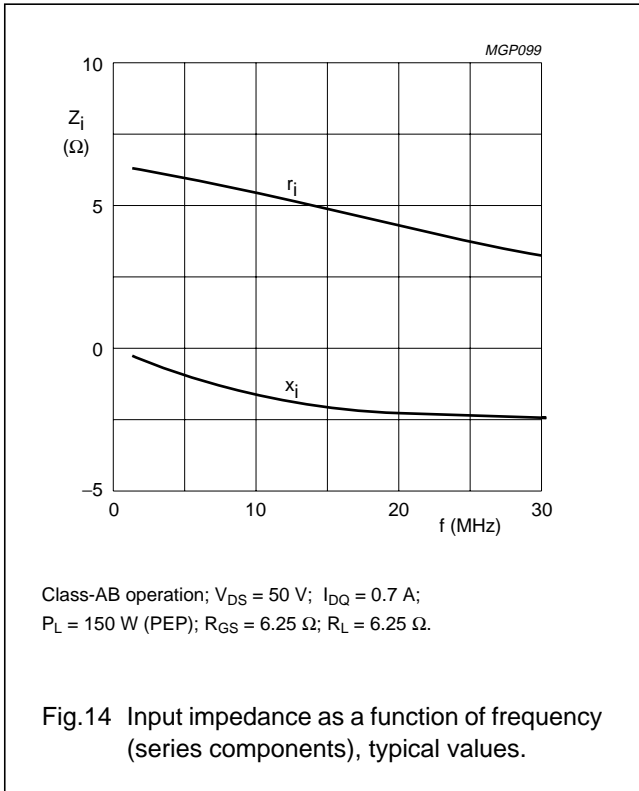

HF/VHF power MOS transistor

BLF177

APPLICATION INFORMATION FOR CLASS-B OPERATION

$T_h = 25\text{ }^\circ\text{C}$; $R_{th\text{ mb-h}} = 0.2\text{ K/W}$; $R_{GS} = 15.8\text{ }\Omega$; unless otherwise specified.
 RF performance in CW operation in a common source class-B test circuit.

MODE OF OPERATION	f (MHz)	V_{DS} (V)	I_{DQ} (A)	P_L (W)	G_P (dB)	η_D (%)
CW, class-B	108	50	0.1	150	typ. 19	typ. 70

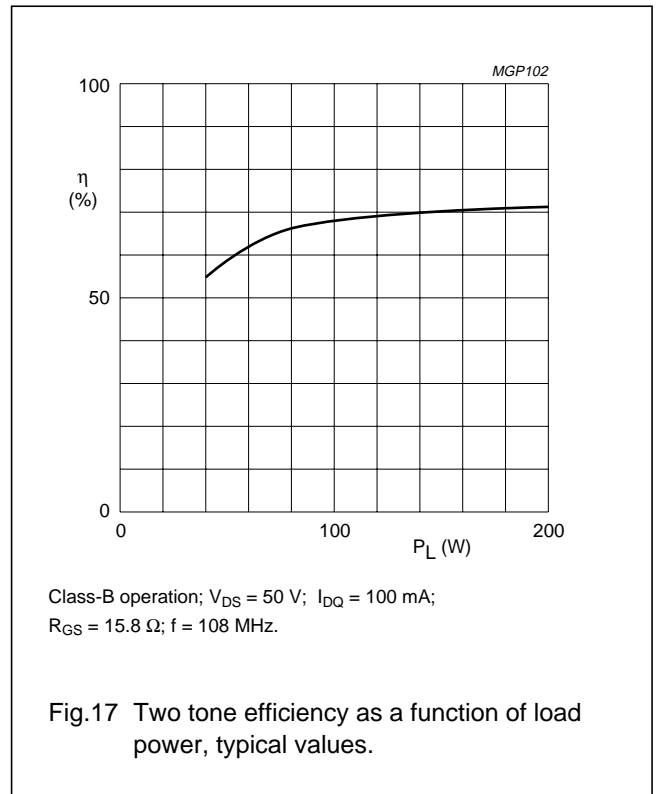
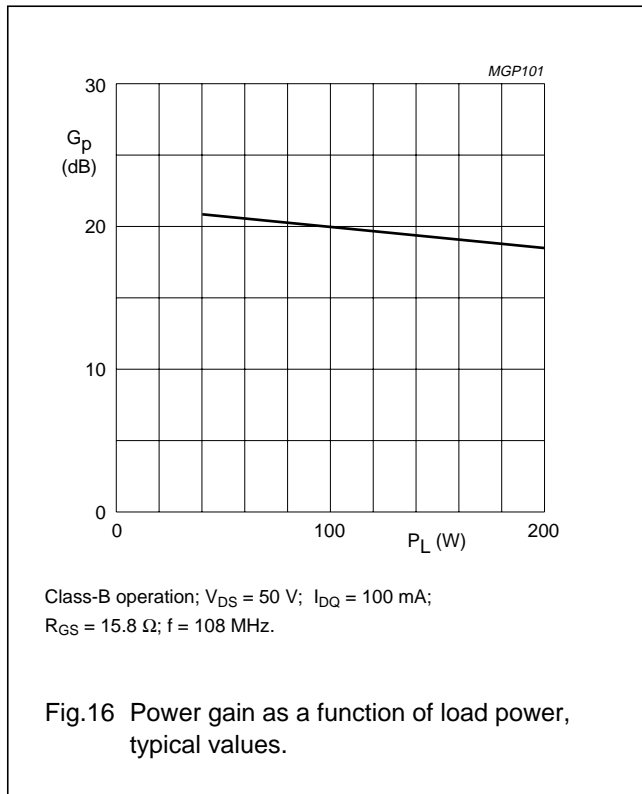

HF/VHF power MOS transistor

BLF177

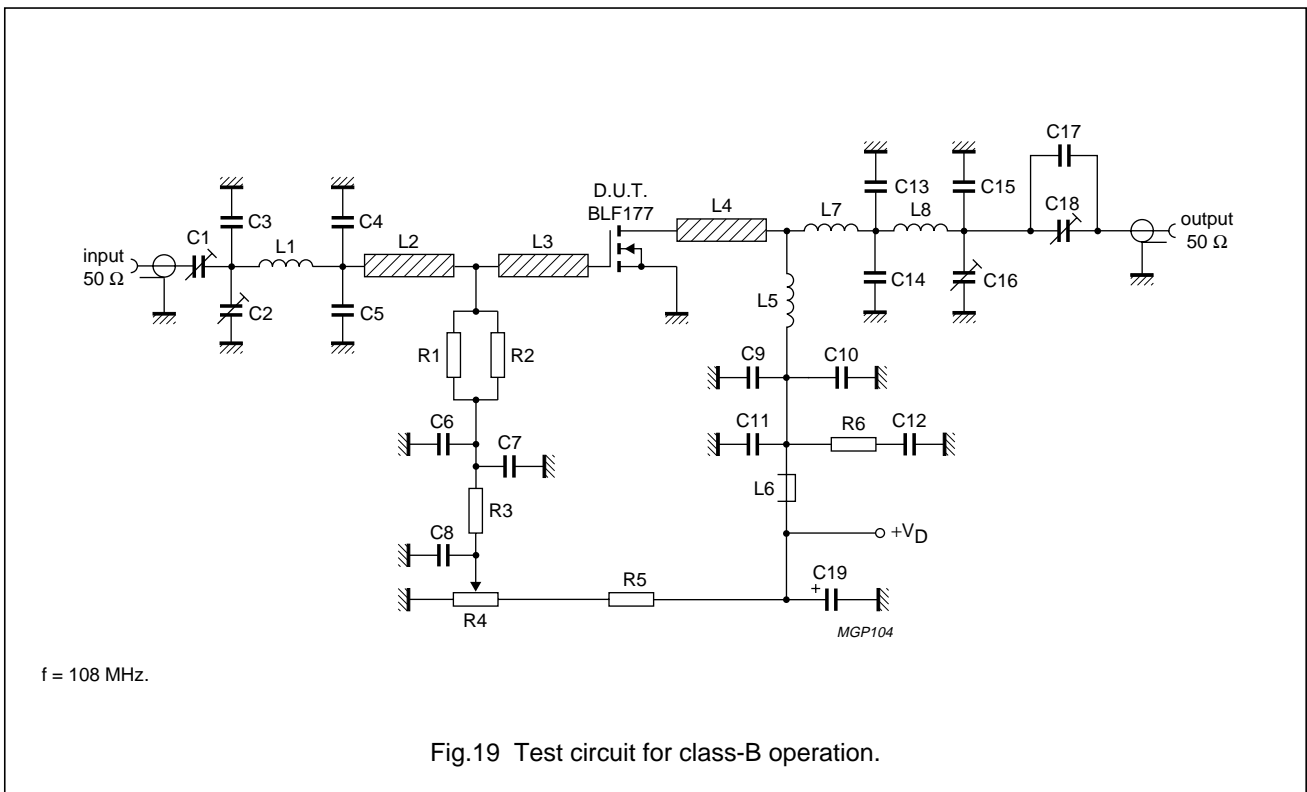
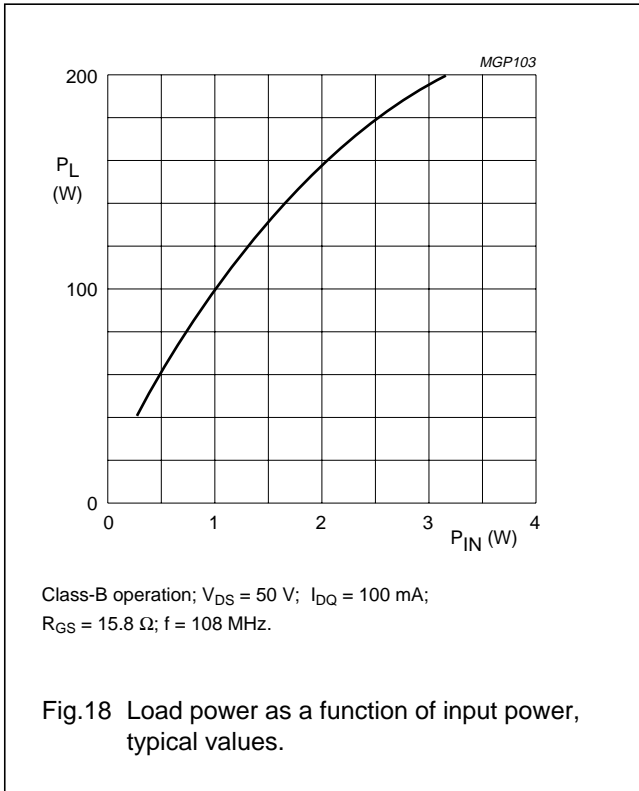

HF/VHF power MOS transistor

BLF177

List of components (class-B test circuit)

COMPONENT	DESCRIPTION	VALUE	DIMENSIONS	CATALOGUE NO.
C1, C2, C16, C18	film dielectric trimmer	2.5 to 20 pF		2222 809 07004
C3	multilayer ceramic chip capacitor (note 1)	20 pF		
C4, C5	multilayer ceramic chip capacitor (note 1)	62 pF		
C6, C7, C9, C10	multilayer ceramic chip capacitor (note 1)	1 nF		
C8	multilayer ceramic chip capacitor	100 nF		2222 852 47104
C11	multilayer ceramic chip capacitor	10 nF		2222 852 47103
C12	multilayer ceramic chip capacitor	3 × 100 nF		2222 852 47104
C13, C14	multilayer ceramic chip capacitor (note 1)	36 pF		
C15	multilayer ceramic chip capacitor (note 1)	12 pF		
C17	multilayer ceramic chip capacitor (note 1)	5.6 pF		
C19	electrolytic capacitor	4.4 μF, 63 V		2222 030 28478
L1	3 turns enamelled 0.8 mm copper wire	22 nH	length 5.5 mm; int. dia. 3 mm; leads 2 × 5 mm	
L2	stripline (note 2)	64.7 Ω	31 × 3 mm	
L3, L4	stripline (note 2)	41.1 Ω	10 × 6 mm	
L5	6 turns enamelled 1.6 mm copper wire	122 nH	length 13.8 mm; int. dia. 6 mm; leads 2 × 5 mm	
L6	grade 3B Ferroxcube wideband HF choke			4312 020 36642
L7	1 turn enamelled 1.6 mm copper wire	16.5 nH	int. dia. 9 mm; leads 2 × 5 mm	
L8	2 turns enamelled 1.6 mm copper wire	34.4 nH	length 3.9 mm; int. dia. 6 mm; leads 2 × 5 mm	
R1, R2	1 W metal film resistor	31.6 Ω		
R3	0.4 W metal film resistor	1 kΩ		
R4	cermet potentiometer	5 kΩ		
R5	0.4 W metal film resistor	44.2 Ω		
R6	1 W metal film resistor	10 Ω		

Notes

- American Technical Ceramics (ATC) capacitor, type 100B or other capacitor of the same quality.
- The striplines are on a double copper-clad printed circuit board, with PTFE fibre-glass dielectric ($\epsilon_r = 2.2$), thickness 1.6 mm.

HF/VHF power MOS transistor

BLF177

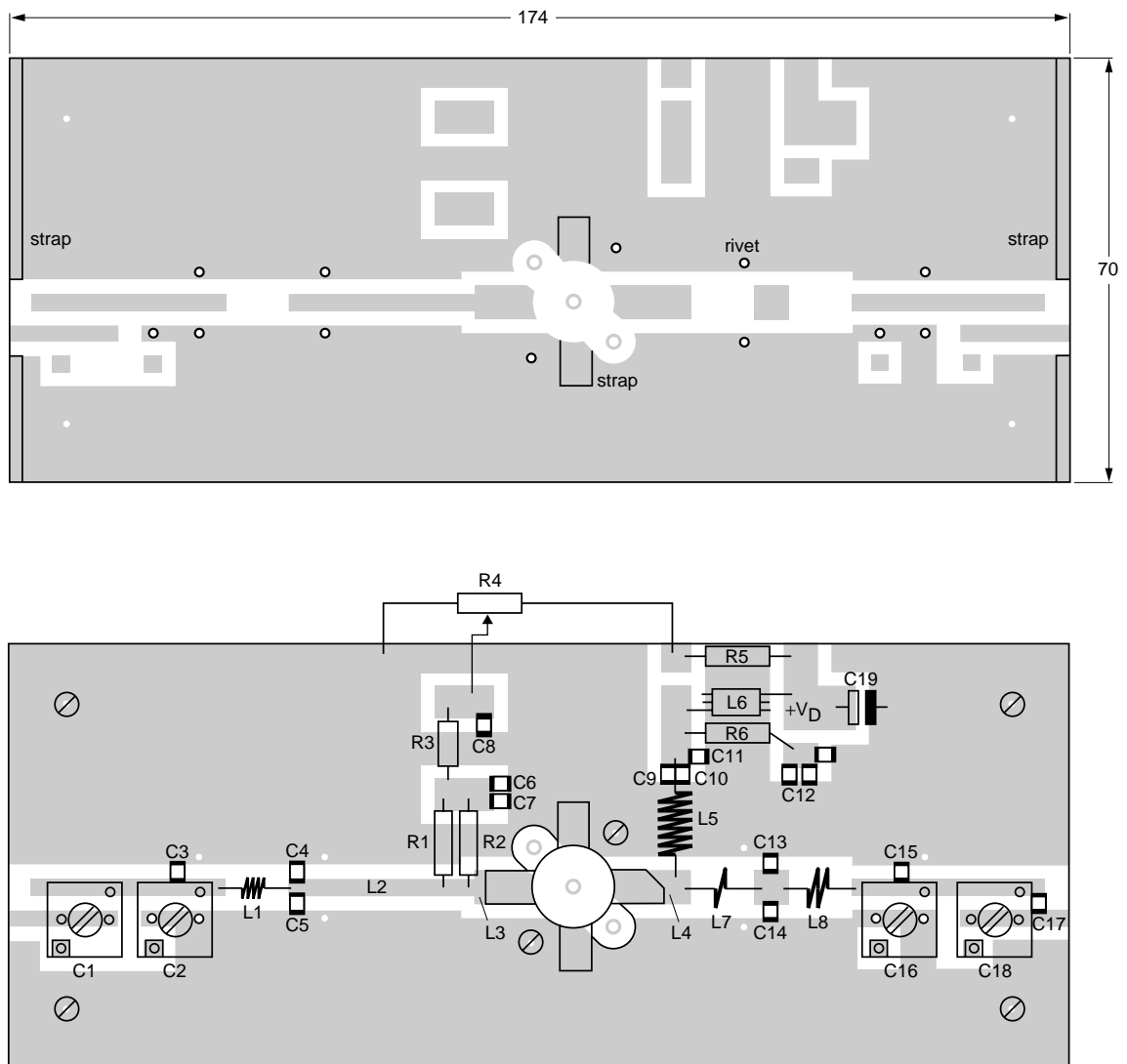

MGP105

The circuit and components are situated on one side of the epoxy fibre-glass board, the other side being fully metallized to serve as earth. Earth connections are made by means of hollow rivets, whilst under the source leads and at the input and output copper straps are used for a direct contact between upper and lower sheets. Dimensions in mm.

Fig.20 Component layout for 108 MHz class-B test circuit.

HF/VHF power MOS transistor

BLF177

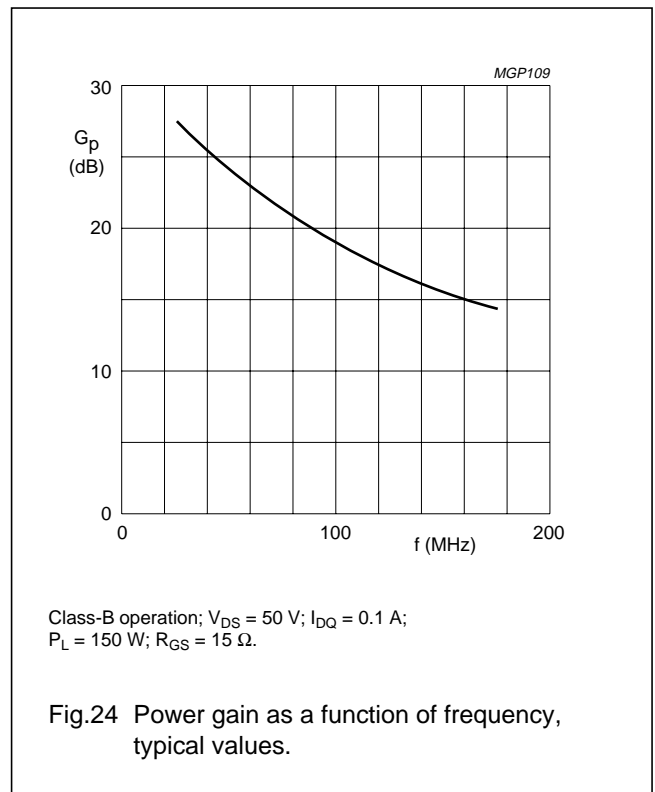
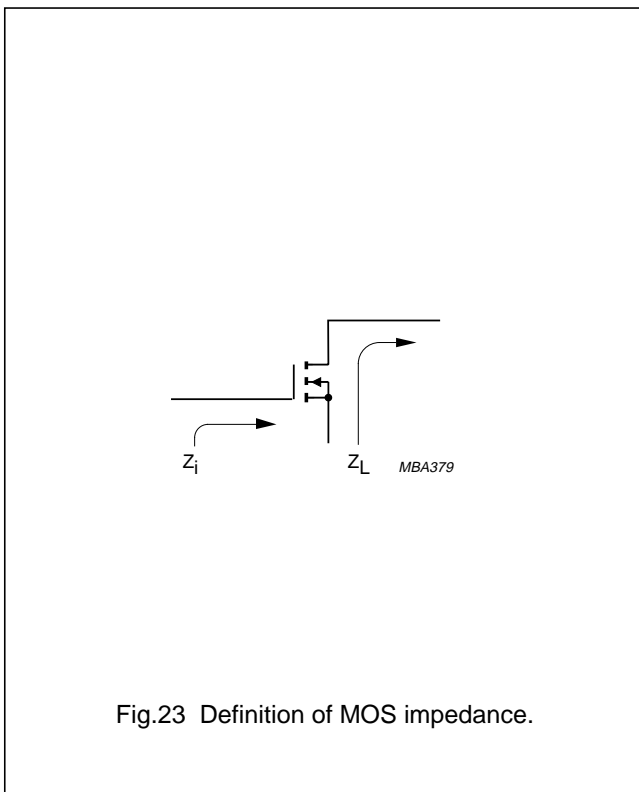
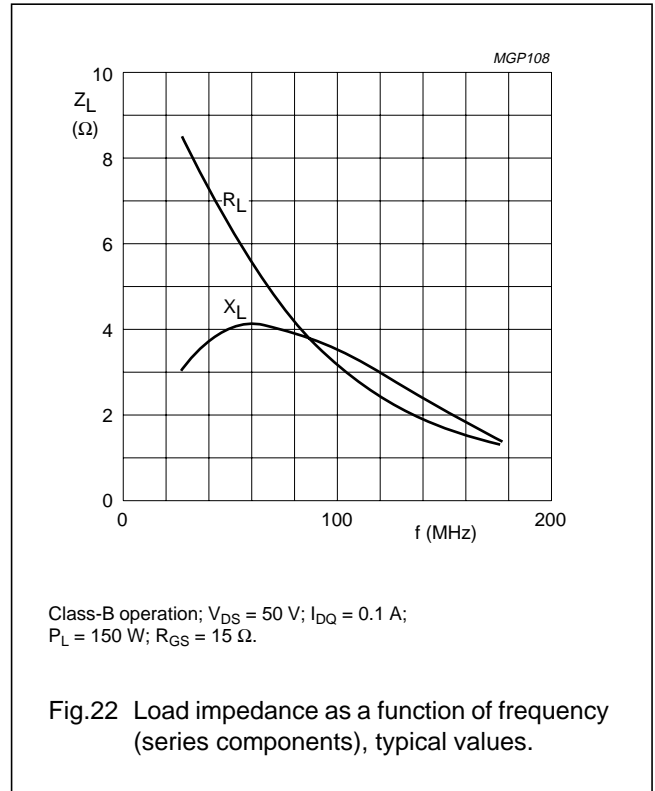
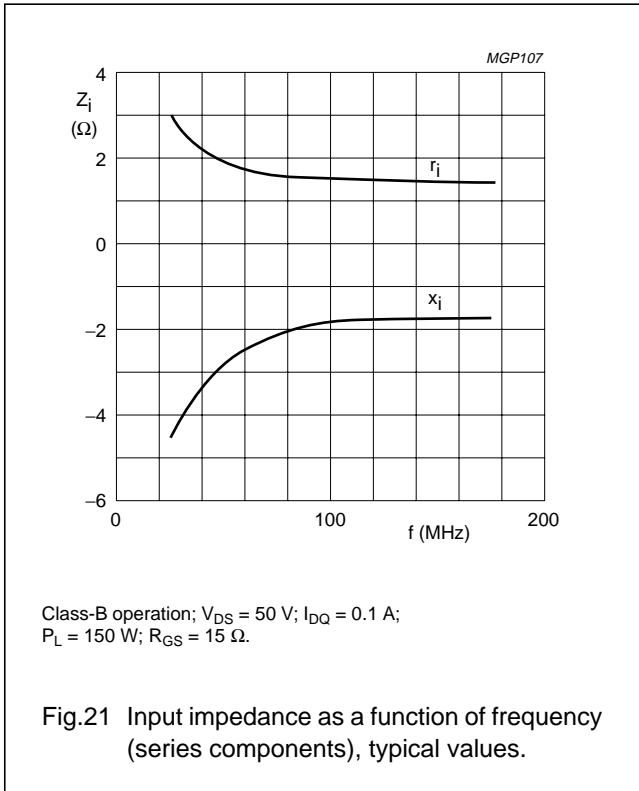

HF/VHF power MOS transistor

BLF177

PACKAGE OUTLINE

Flanged ceramic package; 2 mounting holes; 4 leads

SOT121B

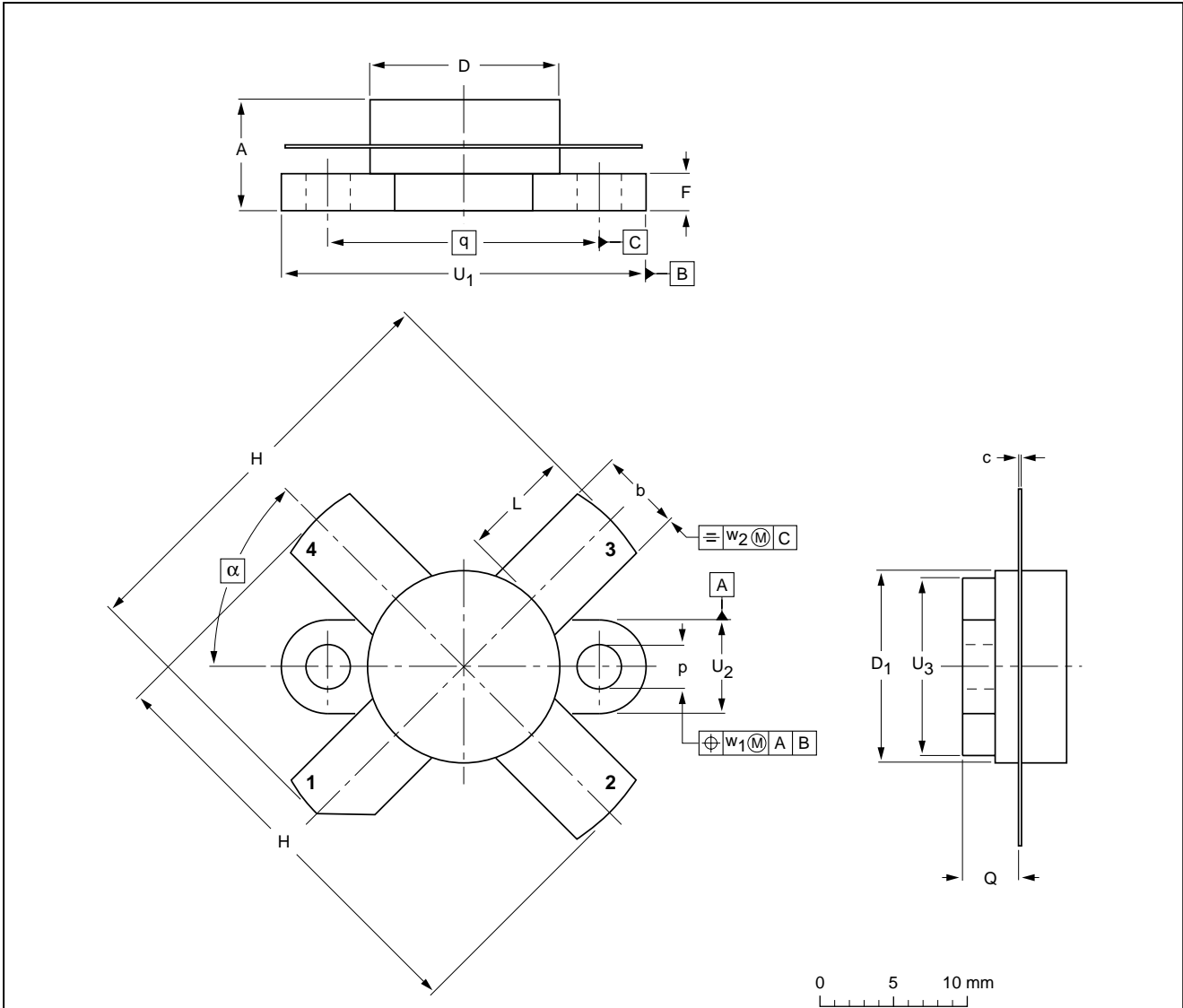

DIMENSIONS (millimetre dimensions are derived from the original inch dimensions)

UNIT	A	b	c	D	D ₁	F	H	L	p	Q	q	U ₁	U ₂	U ₃	w ₁	w ₂	α
mm	7.27 6.17	5.82 5.56	0.16 0.10	12.86 12.59	12.83 12.57	2.67 2.41	28.45 25.52	7.93 6.32	3.30 3.05	4.45 3.91	18.42	24.90 24.63	6.48 6.22	12.32 12.06	0.51	1.02	45°
inches	0.286 0.243	0.229 0.219	0.006 0.004	0.506 0.496	0.505 0.495	0.105 0.095	1.120 1.005	0.312 0.249	0.130 0.120	0.175 0.154	0.725	0.98 0.97	0.255 0.245	0.485 0.475	0.02	0.04	

OUTLINE VERSION	REFERENCES				EUROPEAN PROJECTION	ISSUE DATE
	IEC	JEDEC	EIAJ			
SOT121B						97-06-28

HF/VHF power MOS transistor

BLF177

DEFINITIONS

Data Sheet Status	
Objective specification	This data sheet contains target or goal specifications for product development.
Preliminary specification	This data sheet contains preliminary data; supplementary data may be published later.
Product specification	This data sheet contains final product specifications.
Limiting values	
Limiting values given are in accordance with the Absolute Maximum Rating System (IEC 134). Stress above one or more of the limiting values may cause permanent damage to the device. These are stress ratings only and operation of the device at these or at any other conditions above those given in the Characteristics sections of the specification is not implied. Exposure to limiting values for extended periods may affect device reliability.	
Application information	
Where application information is given, it is advisory and does not form part of the specification.	

LIFE SUPPORT APPLICATIONS

These products are not designed for use in life support appliances, devices, or systems where malfunction of these products can reasonably be expected to result in personal injury. Philips customers using or selling these products for use in such applications do so at their own risk and agree to fully indemnify Philips for any damages resulting from such improper use or sale.