

# SN74LVC8T245 8-BIT DUAL-SUPPLY BUS TRANSCEIVER WITH CONFIGURABLE VOLTAGE TRANSLATION AND 3-STATE OUTPUTS

SCES584 – JULY 2004

- Control Inputs  $V_{IH}/V_{IL}$  Levels Are Referenced to  $V_{CCA}$  Voltage
- $V_{CC}$  Isolation Feature – If Either  $V_{CC}$  Input Is at GND, All I/O Ports Are in the High-Impedance State
- $I_{off}$  Supports Partial-Power-Down Mode Operation
- Fully Configurable Dual-Rail Design Allows Each Port to Operate Over the Full 1.65-V to 5.5-V Power-Supply Range

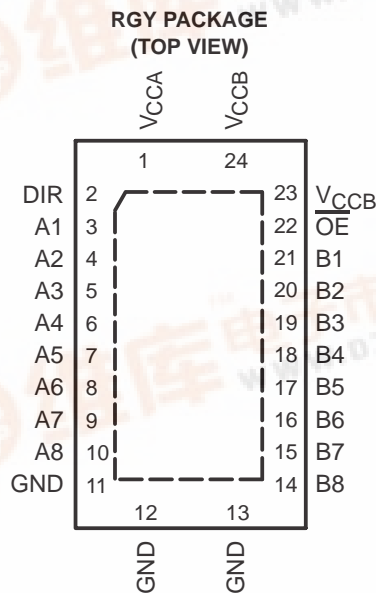
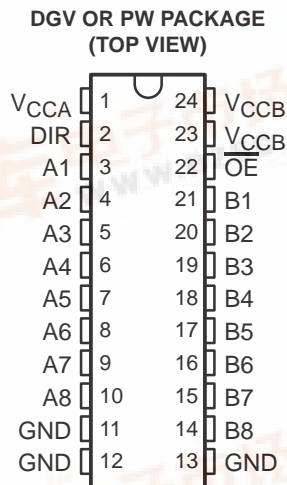

## description/ordering information

This 8-bit noninverting bus transceiver uses two separate configurable power-supply rails. The SN74LVC8T245 is optimized to operate with  $V_{CCA}/V_{CCB}$  set at 1.65 V to 5.5 V. The A port is designed to track  $V_{CCA}$ .  $V_{CCA}$  accepts any supply voltage from 1.65 V to 5.5 V. The B port is designed to track  $V_{CCB}$ .  $V_{CCB}$  accepts any supply voltage from 1.65 V to 5.5 V. This allows for universal low-voltage bidirectional translation between any of the 1.8-V, 2.5-V, 3.3-V, and 5.5-V voltage nodes.

The SN74LVC8T245 is designed for asynchronous communication between data buses. The device transmits data from the A bus to the B bus or from the B bus to the A bus, depending on the logic level at the direction-control (DIR) input. The output-enable ( $\overline{OE}$ ) input can be used to disable the outputs so the buses are effectively isolated.

The SN74LVC8T245 is designed so that the control pins (DIR and  $\overline{OE}$ ) are supplied by  $V_{CCA}$ .

## ORDERING INFORMATION

$T_A$	PACKAGE†		ORDERABLE PART NUMBER	TOP-SIDE MARKING
-40°C to 85°C	QFN – RGY	Tape and reel	SN74LVC8T245RGYR	
	TSSOP – PW	Tube	SN74LVC8T245PW	
		Tape and reel	SN74LVC8T245PWR	
	TVSOP – DGV	Tape and reel	SN74LVC8T245DGVR	

† Package drawings, standard packing quantities, thermal data, symbolization, and PCB design guidelines are available at [www.ti.com/sc/package](http://www.ti.com/sc/package).

Please be aware that an important notice concerning availability, standard warranty, and use in critical applications of Texas Instruments semiconductor products and disclaimers thereto appears at the end of this data sheet.

PRODUCT PREVIEW

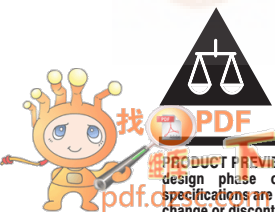

# SN74LVC8T245

## 8-BIT DUAL-SUPPLY BUS TRANSCEIVER

### WITH CONFIGURABLE VOLTAGE TRANSLATION AND 3-STATE OUTPUTS

SCES584 – JULY 2004

#### description/ordering information (continued)

The SN74LVC8T245 solution is compatible with a single-supply system and can be replaced later with a '245 function with minimal PCB redesign.

This device is fully specified for partial-power-down applications using  $I_{off}$ . The  $I_{off}$  circuitry disables the outputs, preventing damaging current backflow through the device when it is powered down.

The  $V_{CC}$  isolation feature ensures that if either  $V_{CC}$  input is at GND, both ports are in the high-impedance state.

To ensure the high-impedance state during power up or power down,  $\overline{OE}$  should be tied to  $V_{CC}$  through a pullup resistor; the minimum value of the resistor is determined by the current-sinking capability of the driver.

**FUNCTION TABLE**  
(each 8-bit section)

INPUTS		OPERATION
$\overline{OE}$	DIR	
L	L	B data to A bus
L	H	A data to B bus
H	X	Isolation

#### logic diagram (positive logic)

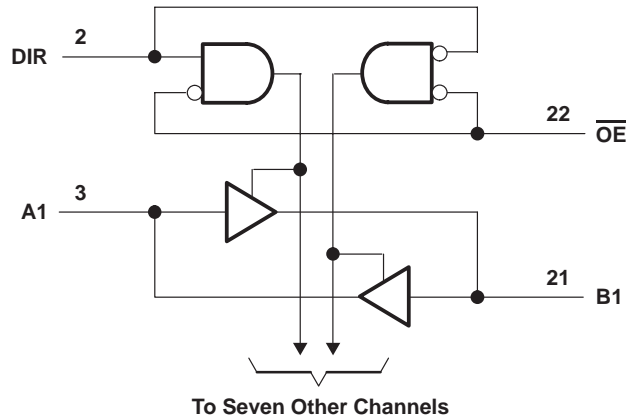

PRODUCT PREVIEW

**SN74LVC8T245**  
**8-BIT DUAL-SUPPLY BUS TRANSCEIVER**  
**WITH CONFIGURABLE VOLTAGE TRANSLATION AND 3-STATE OUTPUTS**

SCES584 – JULY 2004

**absolute maximum ratings over operating free-air temperature range (unless otherwise noted)†**

Supply voltage range, $V_{CCA}$ and $V_{CCB}$ .....	-0.5 V to 6.5 V
Input voltage range, $V_I$ (see Note 1): I/O ports (A port) .....	-0.5 V to 6.5 V
I/O ports (B port) .....	-0.5 V to 6.5 V
Control inputs .....	-0.5 V to 6.5 V
Voltage range applied to any output in the high-impedance or power-off state, $V_O$ (see Note 1): (A port) .....	-0.5 V to 6.5 V
(B port) .....	-0.5 V to 6.5 V
Voltage range applied to any output in the high or low state, $V_O$ (see Notes 1 and 2): (A port) .....	-0.5 V to $V_{CCA} + 0.5$ V
(B port) .....	-0.5 V to $V_{CCB} + 0.5$ V
Input clamp current, $I_{IK}$ ( $V_I < 0$ ) .....	-50 mA
Output clamp current, $I_{OK}$ ( $V_O < 0$ ) .....	-50 mA
Continuous output current, $I_O$ .....	$\pm 50$ mA
Continuous current through $V_{CCA}$ , $V_{CCB}$ , or GND .....	$\pm 100$ mA
Package thermal impedance, $\theta_{JA}$ (see Note 3): DGV package .....	86°C/W
(see Note 3): PW package .....	88°C/W
(see Note 4): RGY package .....	TBD°C/W
Storage temperature range, $T_{stg}$ .....	-65°C to 150°C

† Stresses beyond those listed under “absolute maximum ratings” may cause permanent damage to the device. These are stress ratings only, and functional operation of the device at these or any other conditions beyond those indicated under “recommended operating conditions” is not implied. Exposure to absolute-maximum-rated conditions for extended periods may affect device reliability.

- NOTES:
1. The input and output negative-voltage ratings may be exceeded if the input and output current ratings are observed.
  2. The output positive-voltage rating may be exceeded up to 6.5 V maximum if the output current rating is observed.
  3. The package thermal impedance is calculated in accordance with JESD 51-7.
  4. The package thermal impedance is calculated in accordance with JESD 51-5.

**PRODUCT PREVIEW**

# SN74LVC8T245

## 8-BIT DUAL-SUPPLY BUS TRANSCEIVER

### WITH CONFIGURABLE VOLTAGE TRANSLATION AND 3-STATE OUTPUTS

SCES584 – JULY 2004

recommended operating conditions (see Notes 5 through 7)

		V <sub>CCI</sub>	V <sub>CCO</sub>	MIN	MAX	UNIT
V <sub>CCA</sub>	Supply voltage			1.65	5.5	V
V <sub>CCB</sub>				1.65	5.5	
V <sub>IH</sub>	High-level input voltage	Data inputs (see Note 8)	1.65 V to 1.95 V		V <sub>CCI</sub> × 0.65	V
			2.3 V to 2.7 V		1.7	
			3 V to 3.6 V		2	
			4.5 V to 5.5 V		V <sub>CCI</sub> × 0.7	
V <sub>IL</sub>	Low-level input voltage	Data inputs (see Note 8)	1.65 V to 1.95 V		V <sub>CCI</sub> × 0.35	V
			2.3 V to 2.7 V		0.7	
			3 V to 3.6 V		0.8	
			4.5 V to 5.5 V		V <sub>CCI</sub> × 0.3	
V <sub>IH</sub>	High-level input voltage	DIR (Referenced to V <sub>CCA</sub> ) (see Note 9)	1.65 V to 1.95 V		V <sub>CCA</sub> × 0.65	V
			2.3 V to 2.7 V		1.7	
			3 V to 3.6 V		2	
			4.5 V to 5.5 V		V <sub>CCA</sub> × 0.7	
V <sub>IL</sub>	Low-level input voltage	DIR (Referenced to V <sub>CCA</sub> ) (see Note 9)	1.65 V to 1.95 V		V <sub>CCA</sub> × 0.35	V
			2.3 V to 2.7 V		0.7	
			3 V to 3.6 V		0.8	
			4.5 V to 5.5 V		V <sub>CCA</sub> × 0.3	
V <sub>I</sub>	Input voltage			0	5.5	V
V <sub>O</sub>	Output voltage	Active state		0	V <sub>CCO</sub>	V
		3-State		0	3.6	
I <sub>OH</sub>	High-level output current		1.65 V to 1.95 V		-4	mA
			2.3 V to 2.7 V		-8	
			3 V to 3.6 V		-24	
			4.5 V to 5.5 V		-32	
I <sub>OL</sub>	Low-level output current		1.65 V to 1.95 V		4	mA
			2.3 V to 2.7 V		8	
			3 V to 3.6 V		24	
			4.5 V to 5.5 V		32	
Δt/Δv	Input transition rise or fall rate	Data inputs	1.65 V to 1.95 V		20	ns/V
			2.3 V to 2.7 V		20	
			3 V to 3.6 V		10	
			4.5 V to 5.5 V		5	
T <sub>A</sub>	Operating free-air temperature			-40	85	°C

- NOTES: 5. V<sub>CCI</sub> is the V<sub>CC</sub> associated with the data input port.  
6. V<sub>CCO</sub> is the V<sub>CC</sub> associated with the output port.  
7. All unused data inputs of the device must be held at V<sub>CCI</sub> or GND to ensure proper device operation. Refer to the TI application report, *Implications of Slow or Floating CMOS Inputs*, literature number SCBA004.  
8. For V<sub>CCI</sub> values not specified in the data sheet, V<sub>IH(min)</sub> = V<sub>CCI</sub> × 0.7 V, V<sub>IL(max)</sub> = V<sub>CCI</sub> × 0.3 V.  
9. For V<sub>CCI</sub> values not specified in the data sheet, V<sub>IH(min)</sub> = V<sub>CCA</sub> × 0.7 V, V<sub>IL(max)</sub> = V<sub>CCA</sub> × 0.3 V.

PRODUCT PREVIEW

**SN74LVC8T245**  
**8-BIT DUAL-SUPPLY BUS TRANSCEIVER**  
**WITH CONFIGURABLE VOLTAGE TRANSLATION AND 3-STATE OUTPUTS**

SCES584 – JULY 2004

electrical characteristics over recommended operating free-air temperature range (unless otherwise noted) (see Notes 10 and 11)

PARAMETER	TEST CONDITIONS	V <sub>CCA</sub>	V <sub>CCB</sub>	T <sub>A</sub> = 25°C			-40°C to 85°C		UNIT
				MIN	TYP	MAX	MIN	MAX	
V <sub>OH</sub>	I <sub>OH</sub> = -100 μA, V <sub>I</sub> = V <sub>IH</sub>	1.65 V to 4.5 V	1.65 V to 4.5 V				V <sub>CCO</sub> - 0.1 V		V
	I <sub>OH</sub> = -4 mA, V <sub>I</sub> = V <sub>IH</sub>	1.65 V	1.65 V				1.2		
	I <sub>OH</sub> = -8 mA, V <sub>I</sub> = V <sub>IH</sub>	2.3 V	2.3 V				1.9		
	I <sub>OH</sub> = -24 mA, V <sub>I</sub> = V <sub>IH</sub>	3 V	3 V				2.4		
	I <sub>OH</sub> = -32 mA, V <sub>I</sub> = V <sub>IH</sub>	4.5 V	4.5 V				3.8		
V <sub>OL</sub>	I <sub>OL</sub> = 100 μA, V <sub>I</sub> = V <sub>IL</sub>	1.65 V to 4.5 V	1.65 V to 4.5 V				0.1		V
	I <sub>OL</sub> = 4 mA, V <sub>I</sub> = V <sub>IL</sub>	1.65 V	1.65 V				0.45		
	I <sub>OL</sub> = 8 mA, V <sub>I</sub> = V <sub>IL</sub>	2.3 V	2.3 V				0.3		
	I <sub>OL</sub> = 24 mA, V <sub>I</sub> = V <sub>IL</sub>	3 V	3 V				0.55		
	I <sub>OL</sub> = 32 mA, V <sub>I</sub> = V <sub>IL</sub>	4.5 V	4.5 V				0.55		
I <sub>I</sub>	Control inputs V <sub>I</sub> = V <sub>CCA</sub> or GND	1.65 V to 5.5 V	1.65 V to 5.5 V				±1	±2	μA
I <sub>off</sub>	A or B port V <sub>I</sub> or V <sub>O</sub> = 0 to 5.5 V	0 V	0 to 5.5 V				±1	±2	μA
		0 to 5.5 V	0 V				±1	±2	
I <sub>OZ</sub>	A or B ports V <sub>O</sub> = V <sub>CCO</sub> or GND $\overline{OE} = V_{IH}$	1.65 V to 5.5 V	1.65 V to 5.5 V				±1	±2	μA
I <sub>CCA</sub>	V <sub>I</sub> = V <sub>CCI</sub> or GND I <sub>O</sub> = 0	1.65 V to 5.5 V	1.65 V to 5.5 V					15	μA
		5 V	0 V					15	
		0 V	5 V					-2	
I <sub>CCB</sub>	V <sub>I</sub> = V <sub>CCI</sub> or GND I <sub>O</sub> = 0	1.65 V to 5.5 V	1.65 V to 5.5 V					15	μA
		5 V	0 V					-2	
		0 V	5 V					15	
I <sub>CCA</sub> + I <sub>CCB</sub>	V <sub>I</sub> = V <sub>CCI</sub> or GND I <sub>O</sub> = 0	1.65 V to 5.5 V	1.65 V to 5.5 V					25	μA
ΔI <sub>CCA</sub>	A port One A port at V <sub>CCA</sub> - 0.6 V, DIR at V <sub>CCA</sub> , B port = OPEN							50	μA
	Control inputs DIR at V <sub>CCA</sub> - 0.6 V, B port = OPEN, A port at V <sub>CCA</sub> or GND	3 V to 5.5 V	3 V to 5.5 V					50	
ΔI <sub>CCB</sub>	B port One B port at V <sub>CCB</sub> - 0.6 V, DIR at GND, A port = OPEN	3 V to 5.5 V	3 V to 5.5 V					50	μA
C <sub>i</sub>	Control inputs V <sub>I</sub> = V <sub>CCA</sub> or GND	3.3 V	3.3 V						pF
C <sub>io</sub>	A or B ports V <sub>O</sub> = V <sub>CCA/B</sub> or GND	3.3 V	3.3 V						pF

NOTES: 10. V<sub>CCO</sub> is the V<sub>CC</sub> associated with the output port.

11. V<sub>CCI</sub> is the V<sub>CC</sub> associated with the input port.

PRODUCT PREVIEW

**SN74LVC8T245**  
**8-BIT DUAL-SUPPLY BUS TRANSCEIVER**  
**WITH CONFIGURABLE VOLTAGE TRANSLATION AND 3-STATE OUTPUTS**

SCES584 – JULY 2004

switching characteristics over recommended operating free-air temperature range,  $V_{CCA} = 1.8\text{ V} \pm 0.15\text{ V}$  (unless otherwise noted) (see Figure 1)

PARAMETER	FROM (INPUT)	TO (OUTPUT)	$V_{CCB} = 1.8\text{ V} \pm 0.15\text{ V}$		$V_{CCB} = 2.5\text{ V} \pm 0.2\text{ V}$		$V_{CCB} = 3.3\text{ V} \pm 0.3\text{ V}$		$V_{CCB} = 5\text{ V} \pm 0.5\text{ V}$		UNIT
			MIN	MAX	MIN	MAX	MIN	MAX	MIN	MAX	
$t_{PLH}$	A	B									ns
$t_{PHL}$											
$t_{PLH}$	B	A									ns
$t_{PHL}$											
$t_{PHZ}$	$\overline{OE}$	A									ns
$t_{PLZ}$											
$t_{PHZ}$	$\overline{OE}$	B									ns
$t_{PLZ}$											
$t_{PZH}$	$\overline{OE}$	A									ns
$t_{PZL}$											
$t_{PZH}$	$\overline{OE}$	B									ns
$t_{PZL}$											

switching characteristics over recommended operating free-air temperature range,  $V_{CCA} = 2.5\text{ V} \pm 0.2\text{ V}$  (unless otherwise noted) (see Figure 1)

PARAMETER	FROM (INPUT)	TO (OUTPUT)	$V_{CCB} = 1.8\text{ V} \pm 0.15\text{ V}$		$V_{CCB} = 2.5\text{ V} \pm 0.2\text{ V}$		$V_{CCB} = 3.3\text{ V} \pm 0.3\text{ V}$		$V_{CCB} = 5\text{ V} \pm 0.5\text{ V}$		UNIT
			MIN	MAX	MIN	MAX	MIN	MAX	MIN	MAX	
$t_{PLH}$	A	B									ns
$t_{PHL}$											
$t_{PLH}$	B	A									ns
$t_{PHL}$											
$t_{PHZ}$	$\overline{OE}$	A									ns
$t_{PLZ}$											
$t_{PHZ}$	$\overline{OE}$	B									ns
$t_{PLZ}$											
$t_{PZH}$	$\overline{OE}$	A									ns
$t_{PZL}$											
$t_{PZH}$	$\overline{OE}$	B									ns
$t_{PZL}$											

PRODUCT PREVIEW

**SN74LVC8T245**  
**8-BIT DUAL-SUPPLY BUS TRANSCEIVER**  
**WITH CONFIGURABLE VOLTAGE TRANSLATION AND 3-STATE OUTPUTS**

SCES584 – JULY 2004

switching characteristics over recommended operating free-air temperature range,  $V_{CCA} = 3.3\text{ V} \pm 0.3\text{ V}$  (unless otherwise noted) (see Figure 1)

PARAMETER	FROM (INPUT)	TO (OUTPUT)	$V_{CCB} = 1.8\text{ V} \pm 0.15\text{ V}$		$V_{CCB} = 2.5\text{ V} \pm 0.2\text{ V}$		$V_{CCB} = 3.3\text{ V} \pm 0.3\text{ V}$		$V_{CCB} = 5\text{ V} \pm 0.5\text{ V}$		UNIT
			MIN	MAX	MIN	MAX	MIN	MAX	MIN	MAX	
$t_{PLH}$	A	B									ns
$t_{PHL}$											
$t_{PLH}$	B	A									ns
$t_{PHL}$											
$t_{PHZ}$	$\overline{OE}$	A									ns
$t_{PLZ}$											
$t_{PHZ}$	$\overline{OE}$	B									ns
$t_{PLZ}$											
$t_{PZH}$	$\overline{OE}$	A									ns
$t_{PZL}$											
$t_{PZH}$	$\overline{OE}$	B									ns
$t_{PZL}$											

switching characteristics over recommended operating free-air temperature range,  $V_{CCA} = 5\text{ V} \pm 0.5\text{ V}$  (unless otherwise noted) (see Figure 1)

PARAMETER	FROM (INPUT)	TO (OUTPUT)	$V_{CCB} = 1.8\text{ V} \pm 0.15\text{ V}$		$V_{CCB} = 2.5\text{ V} \pm 0.2\text{ V}$		$V_{CCB} = 3.3\text{ V} \pm 0.3\text{ V}$		$V_{CCB} = 5\text{ V} \pm 0.5\text{ V}$		UNIT
			MIN	MAX	MIN	MAX	MIN	MAX	MIN	MAX	
$t_{PLH}$	A	B									ns
$t_{PHL}$											
$t_{PLH}$	B	A									ns
$t_{PHL}$											
$t_{PHZ}$	$\overline{OE}$	A									ns
$t_{PLZ}$											
$t_{PHZ}$	$\overline{OE}$	B									ns
$t_{PLZ}$											
$t_{PZH}^\dagger$	$\overline{OE}$	A									ns
$t_{PZL}^\dagger$											
$t_{PZH}^\dagger$	$\overline{OE}$	B									ns
$t_{PZL}^\dagger$											

operating characteristics,  $T_A = 25^\circ\text{C}$

PARAMETER		TEST CONDITIONS	$V_{CCA} = V_{CCB} = 1.8\text{ V}$	$V_{CCA} = V_{CCB} = 2.5\text{ V}$	$V_{CCA} = V_{CCB} = 3.3\text{ V}$	$V_{CCA} = V_{CCB} = 5\text{ V}$	UNIT
			TYP	TYP	TYP	TYP	
$C_{pdA}^\dagger$	A port input, B port output	$C_L = 0, f = 10\text{ MHz}, t_r = t_f = 1\text{ ns}$					pF
	B port input, A port output						
$C_{pdB}^\dagger$	A port input, B port output						
	B port input, A port output						

$^\dagger$  Power-dissipation capacitance per transceiver

PRODUCT PREVIEW

**SN74LVC8T245**  
**8-BIT DUAL-SUPPLY BUS TRANSCEIVER**  
**WITH CONFIGURABLE VOLTAGE TRANSLATION AND 3-STATE OUTPUTS**

SCES584 – JULY 2004

**power-up considerations**

A proper power-up sequence always should be followed to avoid excessive supply current, bus contention, oscillations, or other anomalies. To guard against such power-up problems, take the following precautions:

1. Connect ground before any supply voltage is applied.
2. Power up  $V_{CCA}$ .
3.  $V_{CCB}$  can be ramped up along with or after  $V_{CCA}$ .

**typical total static power consumption ( $I_{CCA} + I_{CCB}$ )**

Table 1

$V_{CCB}$	$V_{CCA}$					UNIT
	0 V	1.8 V	2.5 V	3.3 V	5 V	
0 V						μA
1.8 V						
2.5 V						
3.3 V						
5 V						

PRODUCT PREVIEW



**SN74LVC8T245**  
**8-BIT DUAL-SUPPLY BUS TRANSCEIVER**  
**WITH CONFIGURABLE VOLTAGE TRANSLATION AND 3-STATE OUTPUTS**

SCES584 – JULY 2004

**TYPICAL CHARACTERISTICS**

**TYPICAL PROPAGATION DELAY (A TO B) vs LOAD CAPACITANCE**

$T_A = 25^\circ\text{C}$ ,  $V_{CCA} = 1.8\text{ V}$

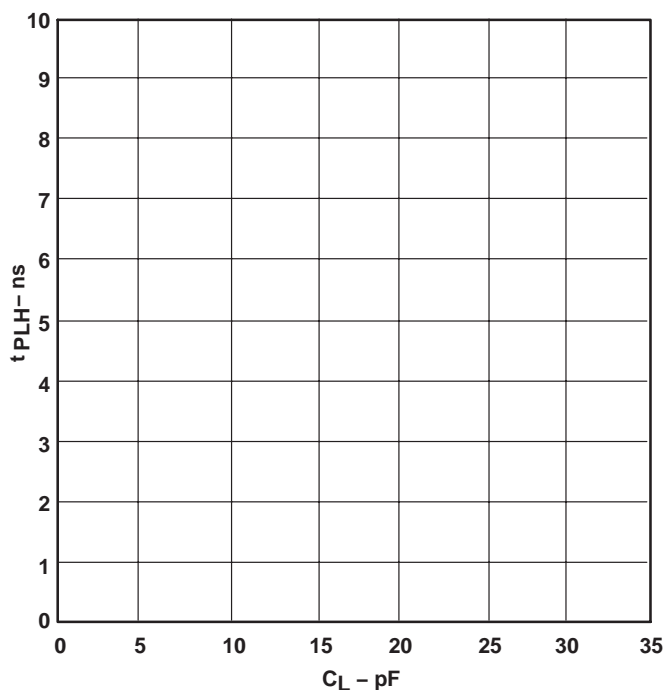
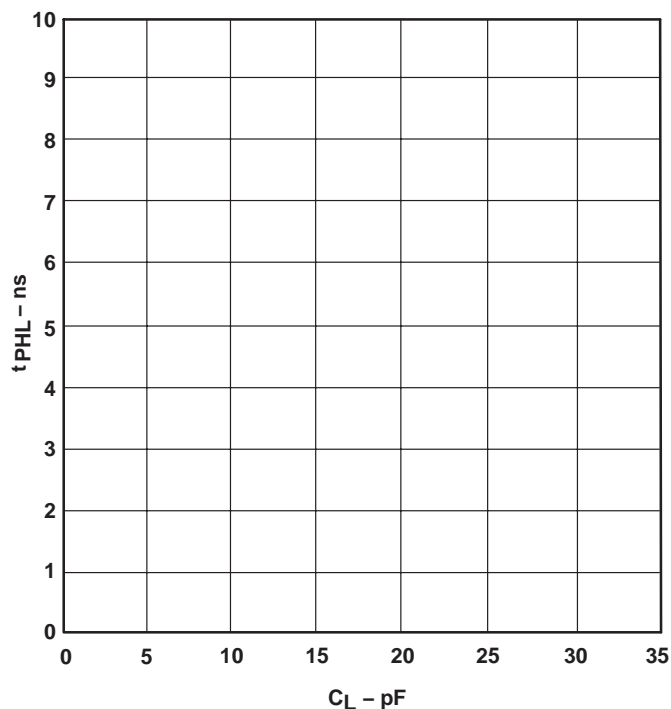

**TYPICAL PROPAGATION DELAY (B TO A) vs LOAD CAPACITANCE**

$T_A = 25^\circ\text{C}$ ,  $V_{CCA} = 1.8\text{ V}$

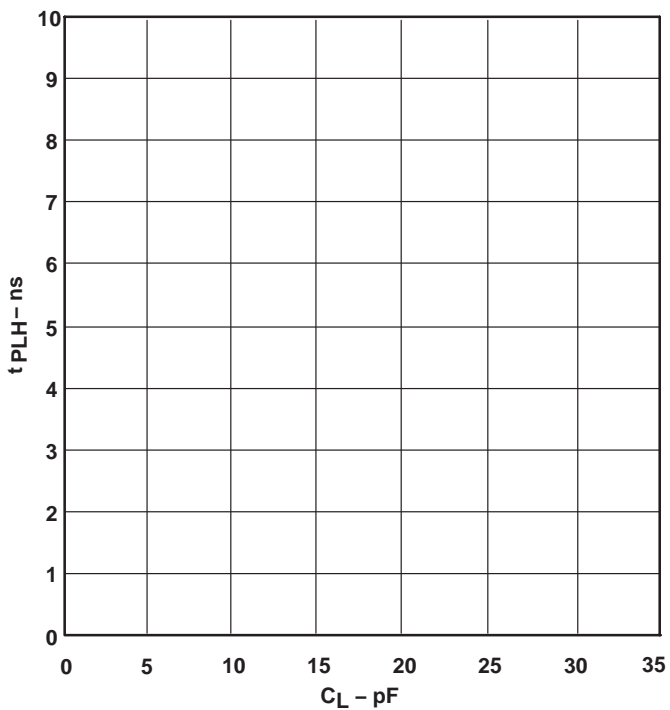
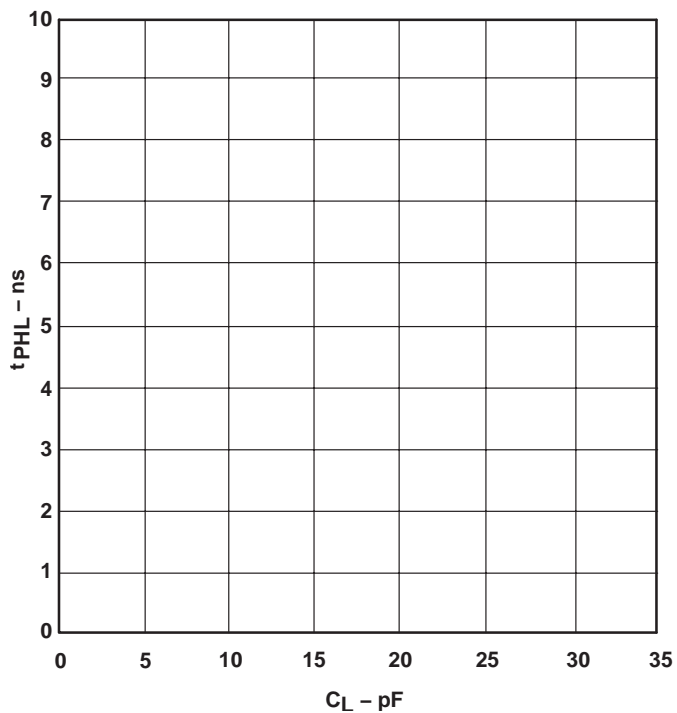

**PRODUCT PREVIEW**

**SN74LVC8T245**  
**8-BIT DUAL-SUPPLY BUS TRANSCEIVER**  
**WITH CONFIGURABLE VOLTAGE TRANSLATION AND 3-STATE OUTPUTS**  
 SCES584 – JULY 2004

**TYPICAL CHARACTERISTICS**

**TYPICAL PROPAGATION DELAY (A TO B) vs LOAD CAPACITANCE**  
 $T_A = 25^\circ\text{C}, V_{CCA} = 2.5\text{ V}$

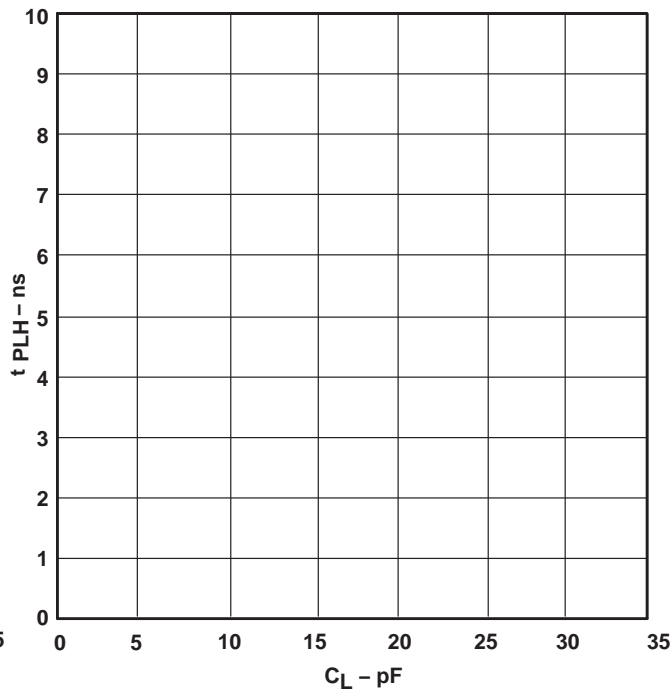
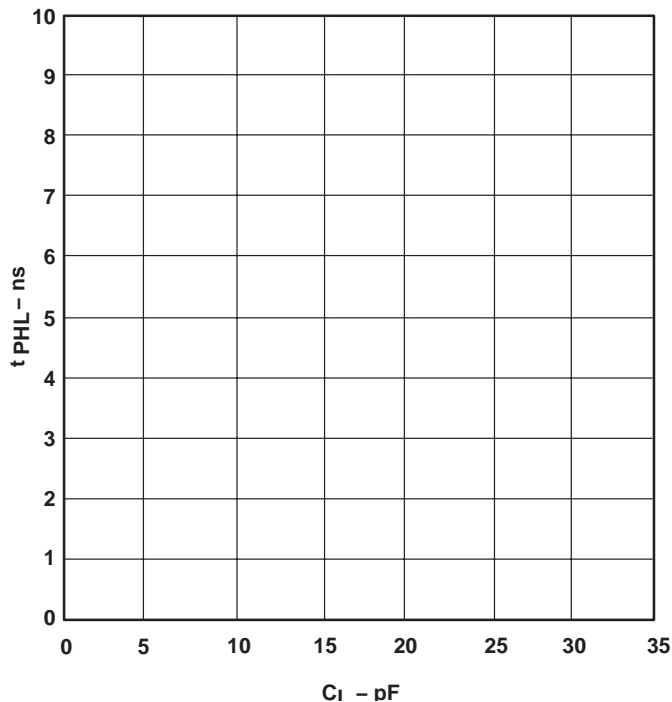

**TYPICAL PROPAGATION DELAY (B TO A) vs LOAD CAPACITANCE**  
 $T_A = 25^\circ\text{C}, V_{CCA} = 2.5\text{ V}$

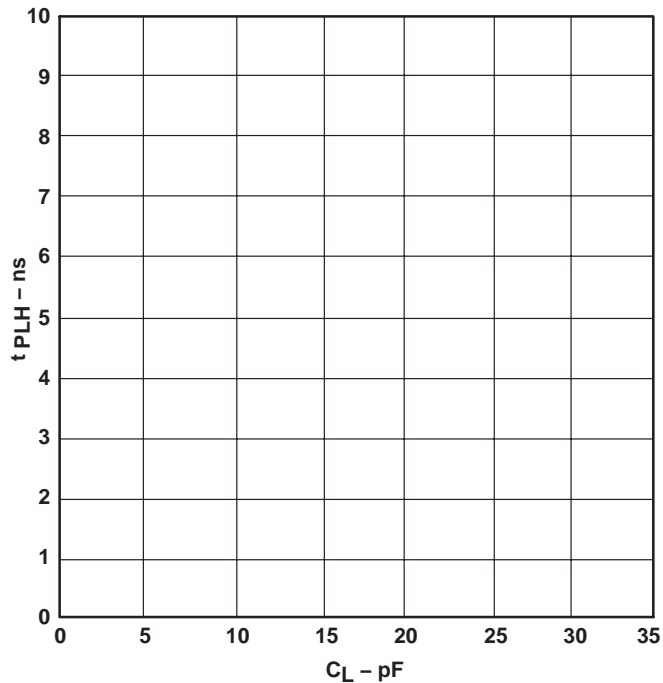
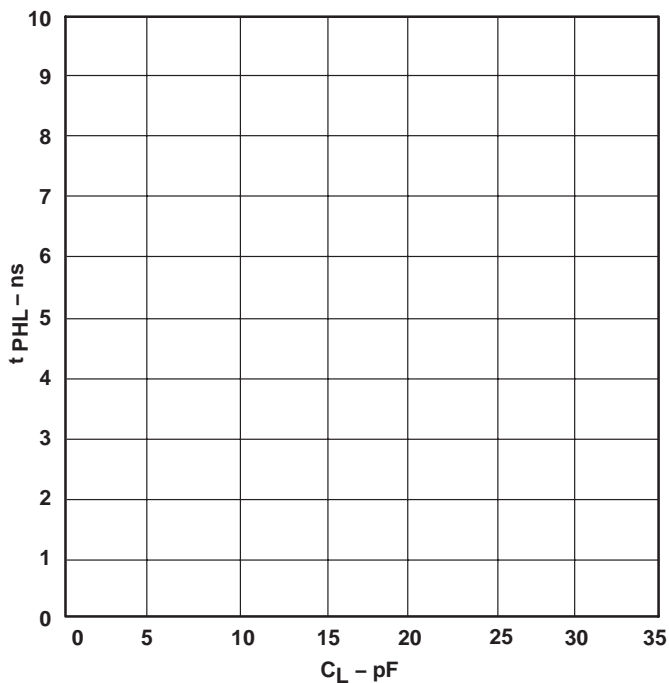

**PRODUCT PREVIEW**

**SN74LVC8T245**  
**8-BIT DUAL-SUPPLY BUS TRANSCEIVER**  
**WITH CONFIGURABLE VOLTAGE TRANSLATION AND 3-STATE OUTPUTS**  
SCES584 – JULY 2004

**TYPICAL CHARACTERISTICS**

**TYPICAL PROPAGATION DELAY (A TO B) vs LOAD CAPACITANCE**  
 $T_A = 25^\circ\text{C}$ ,  $V_{CCA} = 3.3\text{ V}$

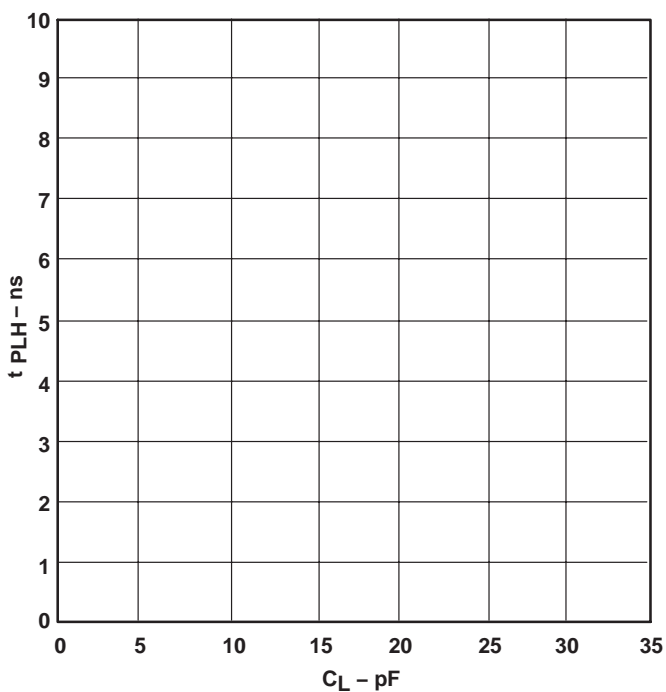
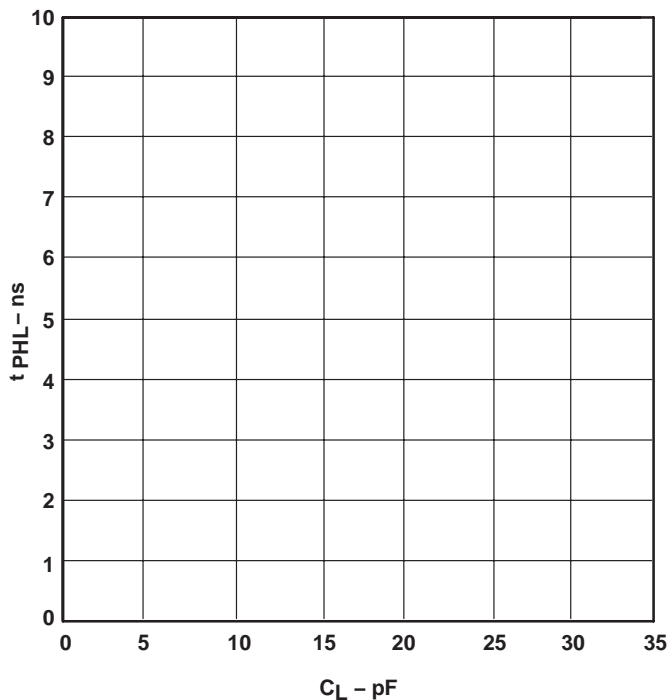

**TYPICAL PROPAGATION DELAY (B TO A) vs LOAD CAPACITANCE**  
 $T_A = 25^\circ\text{C}$ ,  $V_{CCA} = 3.3\text{ V}$

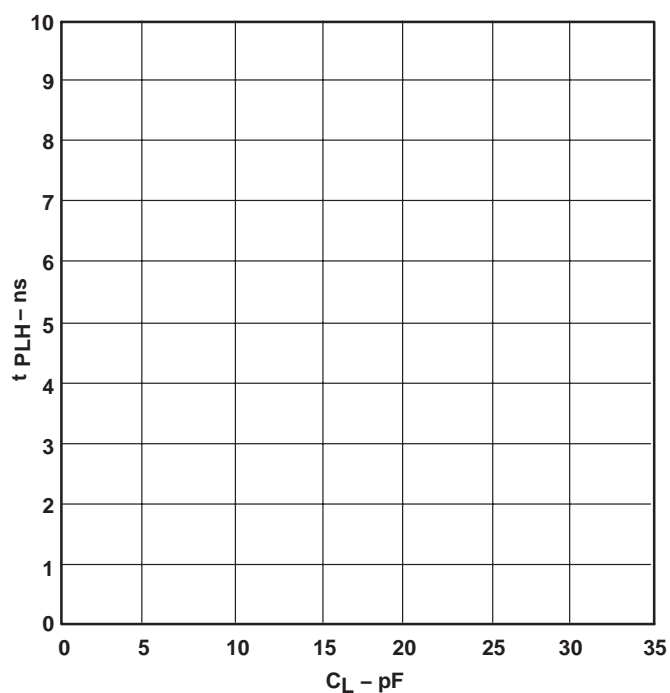
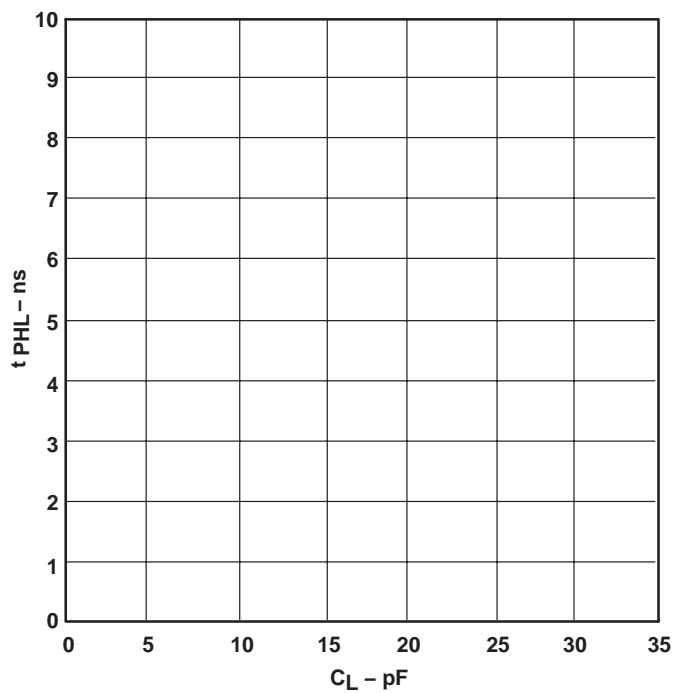

**PRODUCT PREVIEW**

**SN74LVC8T245**  
**8-BIT DUAL-SUPPLY BUS TRANSCEIVER**  
**WITH CONFIGURABLE VOLTAGE TRANSLATION AND 3-STATE OUTPUTS**  
 SCES584 – JULY 2004

PRODUCT PREVIEW

**TYPICAL CHARACTERISTICS**

**TYPICAL PROPAGATION DELAY (A to B) vs LOAD CAPACITANCE**

$T_A = 25^\circ\text{C}, V_{CCA} = 5\text{ V}$

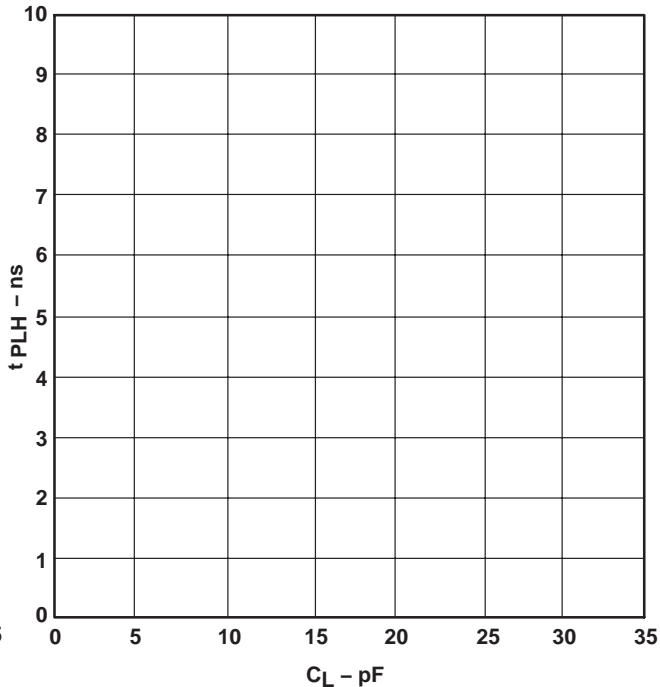
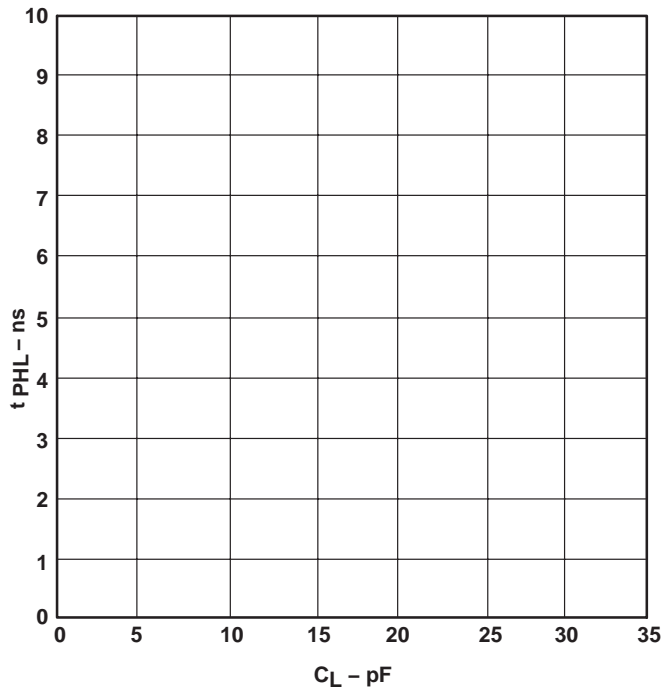

**TYPICAL PROPAGATION DELAY (B to A) vs LOAD CAPACITANCE**

$T_A = 25^\circ\text{C}, V_{CCA} = 5\text{ V}$

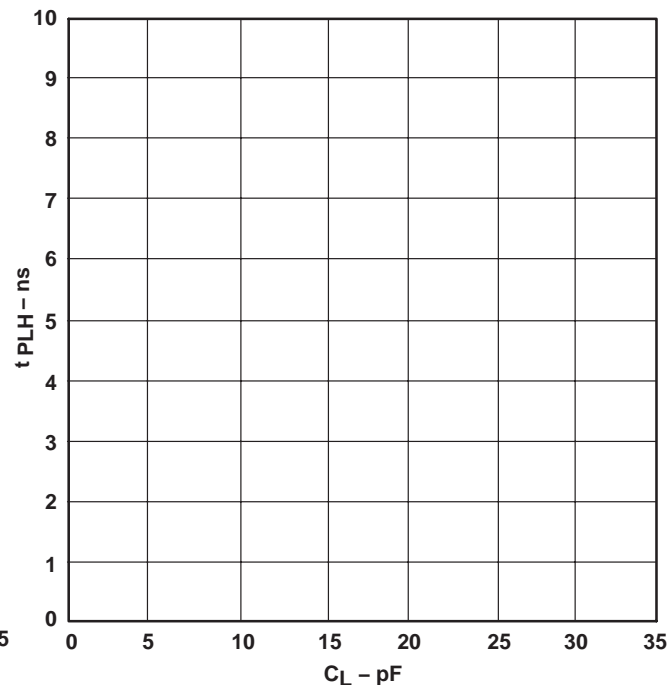
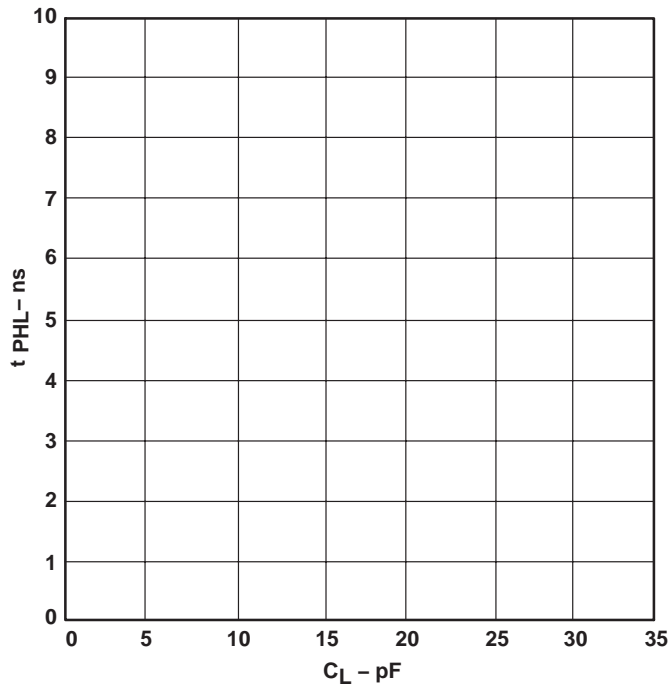

# SN74LVC8T245

## 8-BIT DUAL-SUPPLY BUS TRANSCEIVER

### WITH CONFIGURABLE VOLTAGE TRANSLATION AND 3-STATE OUTPUTS

SCES584 – JULY 2004

#### PARAMETER MEASUREMENT INFORMATION

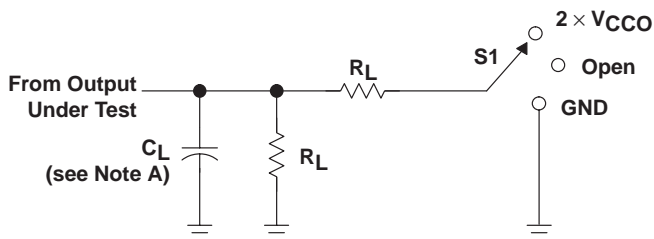

LOAD CIRCUIT

TEST	S1
$t_{pd}$	Open
$t_{PLZ}/t_{PZL}$	$2 \times V_{CCO}$
$t_{PHZ}/t_{PZH}$	GND

$V_{CCO}$	$C_L$	$R_L$	$V_{TP}$
$1.8 \text{ V} \pm 0.15 \text{ V}$	15 pF	2 k $\Omega$	0.15 V
$2.5 \text{ V} \pm 0.2 \text{ V}$	15 pF	2 k $\Omega$	0.15 V
$3.3 \text{ V} \pm 0.3 \text{ V}$	15 pF	2 k $\Omega$	0.3 V
$5 \text{ V} \pm 0.5 \text{ V}$	15 pF	2 k $\Omega$	0.3 V

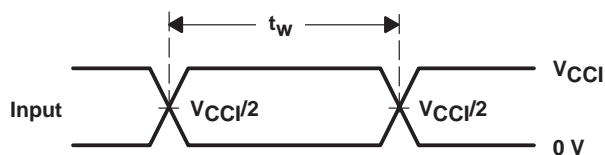

VOLTAGE WAVEFORMS  
PULSE DURATION

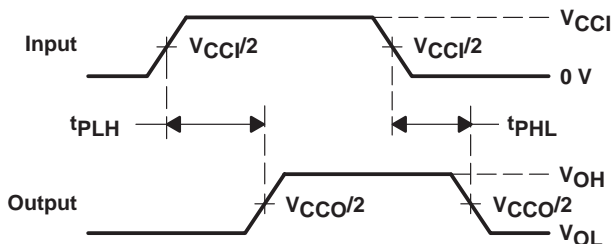

VOLTAGE WAVEFORMS  
PROPAGATION DELAY TIMES

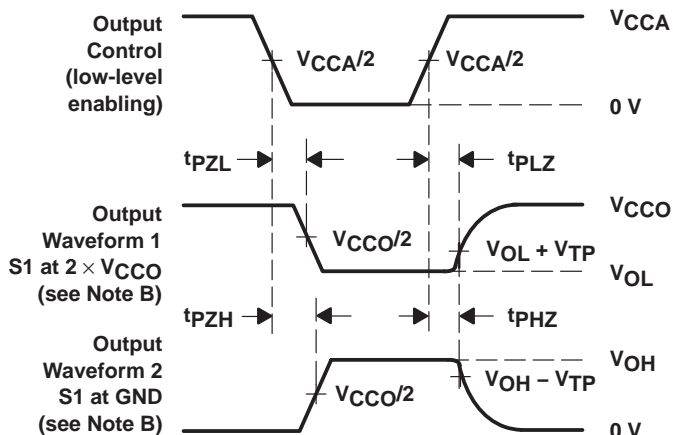

VOLTAGE WAVEFORMS  
ENABLE AND DISABLE TIMES

- NOTES:
- A.  $C_L$  includes probe and jig capacitance.
  - B. Waveform 1 is for an output with internal conditions such that the output is low, except when disabled by the output control. Waveform 2 is for an output with internal conditions such that the output is high, except when disabled by the output control.
  - C. All input pulses are supplied by generators having the following characteristics:  $PRR \leq 10 \text{ MHz}$ ,  $Z_O = 50 \Omega$ ,  $dv/dt \geq 1 \text{ V/ns}$ ,  $dv/dt \geq 1 \text{ V/ns}$ .
  - D. The outputs are measured one at a time, with one transition per measurement.
  - E.  $t_{PLZ}$  and  $t_{PHZ}$  are the same as  $t_{dis}$ .
  - F.  $t_{PZL}$  and  $t_{PZH}$  are the same as  $t_{en}$ .
  - G.  $t_{PLH}$  and  $t_{PHL}$  are the same as  $t_{pd}$ .
  - H.  $V_{CCI}$  is the  $V_{CC}$  associated with the input port.
  - I.  $V_{CCO}$  is the  $V_{CC}$  associated with the output port.
  - J. All parameters and waveforms are not applicable to all devices.

Figure 2. Load Circuit and Voltage Waveforms

PRODUCT PREVIEW

**PACKAGING INFORMATION**

Orderable Device	Status <sup>(1)</sup>	Package Type	Package Drawing	Pins	Package Qty	Eco Plan <sup>(2)</sup>	Lead/Ball Finish	MSL Peak Temp <sup>(3)</sup>
SN74LVC8T245DGVR	PREVIEW	TVSOP	DGV	24	2000	TBD	Call TI	Call TI

<sup>(1)</sup> The marketing status values are defined as follows:

**ACTIVE:** Product device recommended for new designs.

**LIFEBUY:** TI has announced that the device will be discontinued, and a lifetime-buy period is in effect.

**NRND:** Not recommended for new designs. Device is in production to support existing customers, but TI does not recommend using this part in a new design.

**PREVIEW:** Device has been announced but is not in production. Samples may or may not be available.

**OBSELETE:** TI has discontinued the production of the device.

<sup>(2)</sup> Eco Plan - The planned eco-friendly classification: Pb-Free (RoHS) or Green (RoHS & no Sb/Br) - please check <http://www.ti.com/productcontent> for the latest availability information and additional product content details.

**TBD:** The Pb-Free/Green conversion plan has not been defined.

**Pb-Free (RoHS):** TI's terms "Lead-Free" or "Pb-Free" mean semiconductor products that are compatible with the current RoHS requirements for all 6 substances, including the requirement that lead not exceed 0.1% by weight in homogeneous materials. Where designed to be soldered at high temperatures, TI Pb-Free products are suitable for use in specified lead-free processes.

**Green (RoHS & no Sb/Br):** TI defines "Green" to mean Pb-Free (RoHS compatible), and free of Bromine (Br) and Antimony (Sb) based flame retardants (Br or Sb do not exceed 0.1% by weight in homogeneous material)

<sup>(3)</sup> MSL, Peak Temp. -- The Moisture Sensitivity Level rating according to the JEDEC industry standard classifications, and peak solder temperature.

**Important Information and Disclaimer:**The information provided on this page represents TI's knowledge and belief as of the date that it is provided. TI bases its knowledge and belief on information provided by third parties, and makes no representation or warranty as to the accuracy of such information. Efforts are underway to better integrate information from third parties. TI has taken and continues to take reasonable steps to provide representative and accurate information but may not have conducted destructive testing or chemical analysis on incoming materials and chemicals. TI and TI suppliers consider certain information to be proprietary, and thus CAS numbers and other limited information may not be available for release.

In no event shall TI's liability arising out of such information exceed the total purchase price of the TI part(s) at issue in this document sold by TI to Customer on an annual basis.

# MECHANICAL DATA

MPDS006C – FEBRUARY 1996 – REVISED AUGUST 2000

## DGV (R-PDSO-G\*\*)

## PLASTIC SMALL-OUTLINE

24 PINS SHOWN

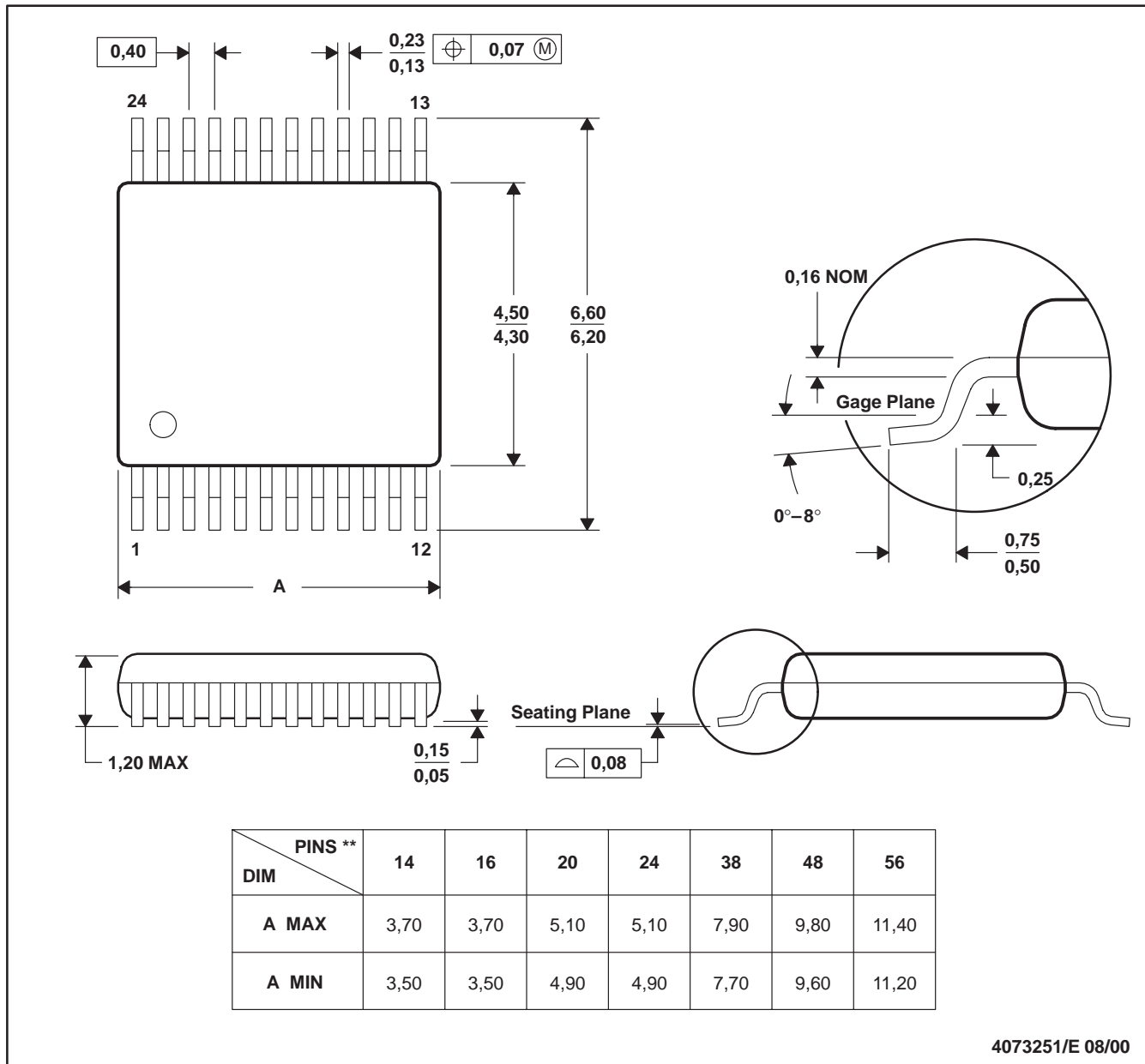

- NOTES: A. All linear dimensions are in millimeters.  
 B. This drawing is subject to change without notice.  
 C. Body dimensions do not include mold flash or protrusion, not to exceed 0,15 per side.  
 D. Falls within JEDEC: 24/48 Pins – MO-153  
 14/16/20/56 Pins – MO-194

## IMPORTANT NOTICE

Texas Instruments Incorporated and its subsidiaries (TI) reserve the right to make corrections, modifications, enhancements, improvements, and other changes to its products and services at any time and to discontinue any product or service without notice. Customers should obtain the latest relevant information before placing orders and should verify that such information is current and complete. All products are sold subject to TI's terms and conditions of sale supplied at the time of order acknowledgment.

TI warrants performance of its hardware products to the specifications applicable at the time of sale in accordance with TI's standard warranty. Testing and other quality control techniques are used to the extent TI deems necessary to support this warranty. Except where mandated by government requirements, testing of all parameters of each product is not necessarily performed.

TI assumes no liability for applications assistance or customer product design. Customers are responsible for their products and applications using TI components. To minimize the risks associated with customer products and applications, customers should provide adequate design and operating safeguards.

TI does not warrant or represent that any license, either express or implied, is granted under any TI patent right, copyright, mask work right, or other TI intellectual property right relating to any combination, machine, or process in which TI products or services are used. Information published by TI regarding third-party products or services does not constitute a license from TI to use such products or services or a warranty or endorsement thereof. Use of such information may require a license from a third party under the patents or other intellectual property of the third party, or a license from TI under the patents or other intellectual property of TI.

Reproduction of information in TI data books or data sheets is permissible only if reproduction is without alteration and is accompanied by all associated warranties, conditions, limitations, and notices. Reproduction of this information with alteration is an unfair and deceptive business practice. TI is not responsible or liable for such altered documentation.

Resale of TI products or services with statements different from or beyond the parameters stated by TI for that product or service voids all express and any implied warranties for the associated TI product or service and is an unfair and deceptive business practice. TI is not responsible or liable for any such statements.

Following are URLs where you can obtain information on other Texas Instruments products and application solutions:

<b>Products</b>		<b>Applications</b>	
Amplifiers	<a href="http://amplifier.ti.com">amplifier.ti.com</a>	Audio	<a href="http://www.ti.com/audio">www.ti.com/audio</a>
Data Converters	<a href="http://dataconverter.ti.com">dataconverter.ti.com</a>	Automotive	<a href="http://www.ti.com/automotive">www.ti.com/automotive</a>
DSP	<a href="http://dsp.ti.com">dsp.ti.com</a>	Broadband	<a href="http://www.ti.com/broadband">www.ti.com/broadband</a>
Interface	<a href="http://interface.ti.com">interface.ti.com</a>	Digital Control	<a href="http://www.ti.com/digitalcontrol">www.ti.com/digitalcontrol</a>
Logic	<a href="http://logic.ti.com">logic.ti.com</a>	Military	<a href="http://www.ti.com/military">www.ti.com/military</a>
Power Mgmt	<a href="http://power.ti.com">power.ti.com</a>	Optical Networking	<a href="http://www.ti.com/opticalnetwork">www.ti.com/opticalnetwork</a>
Microcontrollers	<a href="http://microcontroller.ti.com">microcontroller.ti.com</a>	Security	<a href="http://www.ti.com/security">www.ti.com/security</a>
		Telephony	<a href="http://www.ti.com/telephony">www.ti.com/telephony</a>
		Video & Imaging	<a href="http://www.ti.com/video">www.ti.com/video</a>
		Wireless	<a href="http://www.ti.com/wireless">www.ti.com/wireless</a>

Mailing Address: Texas Instruments  
Post Office Box 655303 Dallas, Texas 75265