



May 1998

LF444 Quad Low Power JFET Input Operational Amplifier

General Description

The LF444 quad low power operational amplifier provides many of the same AC characteristics as the industry standard LM148 while greatly improving the DC characteristics of the LM148. The amplifier has the same bandwidth, slew rate, and gain (10 kΩ load) as the LM148 and only draws one fourth the supply current of the LM148. In addition the well matched high voltage JFET input devices of the LF444 reduce the input bias and offset currents by a factor of 10,000 over the LM148. The LF444 also has a very low equivalent input noise voltage for a low power amplifier.

The LF444 is pin compatible with the LM148 allowing an immediate 4 times reduction in power drain in many applications. The LF444 should be used wherever low power dissipation and good electrical characteristics are the major considerations.

Features

- ¼ supply current of a LM148: 200 μA/Amplifier (max)
- Low input bias current: 50 pA (max)
- High gain bandwidth: 1 MHz
- High slew rate: 1 V/μs
- Low noise voltage for low power
 - 35 nV/√Hz
- Low input noise current
 - 0.01 pA/√Hz
- High input impedance: 10¹²Ω
- High gain V_O = ±10V, R_L = 10k: 50k (min)

Simplified Schematic

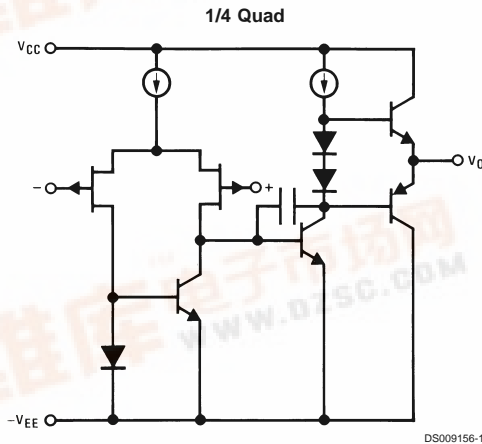

Connection Diagram

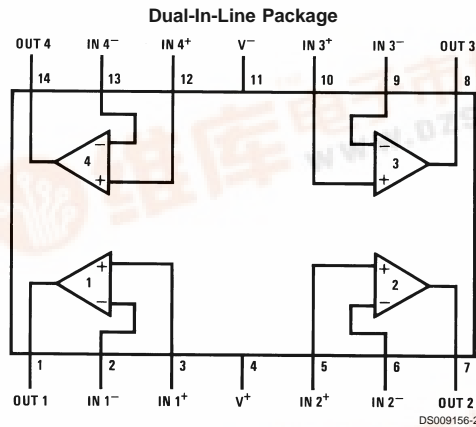

Ordering Information

LF444XYZ

X indicates electrical grade

Y indicates temperature range

"M" for military, "C" for commercial

Z indicates package type "D", "M" or "N"

Top View

Order Number LF444AMD, LF444CM,
LF444ACN, LF444CN or LF444MD/883
See NS Package Number D14E, M14A or N14A

BI-FET™ and BI-FET II™ are trademarks of National Semiconductor Corporation.

LF444 Quad Low Power JFET Input Operational Amplifier



Absolute Maximum Ratings (Note 11)

If Military/Aerospace specified devices are required, please contact the National Semiconductor Sales Office/ Distributors for availability and specifications.

	LF444A	LF444
Supply Voltage	±22V	±18V
Differential Input Voltage	±38V	±30V
Input Voltage Range (Note 1)	±19V	±15V
Output Short Circuit Duration (Note 2)	Continuous	Continuous
	D Package	N, M Packages
Power Dissipation (Notes 3, 9)	900 mW	670 mW
T _j max	150°C	115°C
θ _{JA} (Typical)	100°C/W	85°C/W

Operating Temperature Range
Storage Temperature Range
ESD Tolerance (Note 10)

LF444A/LF444
(Note 4)
-65°C ≤ T_A ≤ 150°C
Rating to
be determined

Soldering Information

Dual-In-Line Packages
(Soldering, 10 sec.) 260°C
Small Outline Package
Vapor Phase (60 sec.) 215°C
Infrared (15 sec.) 220°C

See AN-450 "Surface Mounting Methods and Their Effect on Product Reliability" for other methods of soldering surface mount devices.

DC Electrical Characteristics (Note 5)

Symbol	Parameter	Conditions	LF444A			LF444			Units	
			Min	Typ	Max	Min	Typ	Max		
V _{OS}	Input Offset Voltage	R _S = 10k, T _A = 25°C		2	5		3	10	mV	
		0°C ≤ T _A ≤ +70°C			6.5			12	mV	
		-55°C ≤ T _A ≤ +125°C			8				mV	
ΔV _{OS} /ΔT	Average TC of Input Offset Voltage	R _S = 10 kΩ		10			10		μV/°C	
I _{OS}	Input Offset Current	V _S = ±15V (Notes 5, 6)	T _J = 25°C	5	25		5	50	pA	
			T _J = 70°C			1.5		1.5	nA	
			T _J = 125°C			10			nA	
I _B	Input Bias Current	V _S = ±15V (Notes 5, 6)	T _J = 25°C		10	50		10	100	pA
			T _J = 70°C			3			3	nA
			T _J = 125°C			20				nA
R _{IN}	Input Resistance	T _J = 25°C		10 ¹²			10 ¹²		Ω	
A _{VOL}	Large Signal Voltage Gain	V _S = ±15V, V _O = ±10V	50	100		25	100		V/mV	
		R _L = 10 kΩ, T _A = 25°C								
		Over Temperature	25			15				V/mV
V _O	Output Voltage Swing	V _S = ±15V, R _L = 10 kΩ	±12	±13		±12	±13		V	
V _{CM}	Input Common-Mode Voltage Range		±16	+18		±11	+14		V	
				-17			-12		V	
CMRR	Common-Mode Rejection Ratio	R _S ≤ 10 kΩ	80	100		70	95		dB	
PSRR	Supply Voltage Rejection Ratio	(Note 7)	80	100		70	90		dB	
I _S	Supply Current			0.6	0.8		0.6	1.0	mA	

AC Electrical Characteristics (Note 5)

Symbol	Parameter	Conditions	LF444A			LF444			Units
			Min	Typ	Max	Min	Typ	Max	
	Amplifier-to-Amplifier Coupling			-120			-120		dB
SR	Slew Rate	$V_S = \pm 15V, T_A = 25^\circ C$		1			1		V/ μs
GBW	Gain-Bandwidth Product	$V_S = \pm 15V, T_A = 25^\circ C$		1			1		MHz
e_n	Equivalent Input Noise Voltage	$T_A = 25^\circ C, R_S = 100\Omega,$ $f = 1 \text{ kHz}$		35			35		nV/ \sqrt{Hz}
i_n	Equivalent Input Noise Current	$T_A = 25^\circ C, f = 1 \text{ kHz}$		0.01			0.01		pA/ \sqrt{Hz}

Note 1: Unless otherwise specified the absolute maximum negative input voltage is equal to the negative power supply voltage.

Note 2: Any of the amplifier outputs can be shorted to ground indefinitely, however, more than one should not be simultaneously shorted as the maximum junction temperature will be exceeded.

Note 3: For operating at elevated temperature, these devices must be derated based on a thermal resistance of θ_{JA} .

Note 4: The LF444A is available in both the commercial temperature range $0^\circ C \leq T_A \leq 70^\circ C$ and the military temperature range $-55^\circ C \leq T_A \leq 125^\circ C$. The LF444 is available in the commercial temperature range only. The temperature range is designated by the position just before the package type in the device number. A "C" indicates the commercial temperature range and an "M" indicates the military temperature range. The military temperature range is available in "D" package only.

Note 5: Unless otherwise specified the specifications apply over the full temperature range and for $V_S = \pm 20V$ for the LF444A and for $V_S = \pm 15V$ for the LF444. V_{OS} , I_B , and I_{OS} are measured at $V_{CM} = 0$.

Note 6: The input bias currents are junction leakage currents which approximately double for every $10^\circ C$ increase in the junction temperature, T_J . Due to limited production test time, the input bias currents measured are correlated to junction temperature. In normal operation the junction temperature rises above the ambient temperature as a result of internal power dissipation, P_D . $T_J = T_A + \theta_{JA}P_D$ where θ_{JA} is the thermal resistance from junction to ambient. Use of a heat sink is recommended if input bias current is to be kept to a minimum.

Note 7: Supply voltage rejection ratio is measured for both supply magnitudes increasing or decreasing simultaneously in accordance with common practice from $\pm 15V$ to $\pm 5V$ for the LF444 and from $\pm 20V$ to $\pm 5V$ for the LF444A.

Note 8: Refer to RETS444X for LF444MD military specifications.

Note 9: Max. Power Dissipation is defined by the package characteristics. Operating the part near the Max. Power Dissipation may cause the part to operate outside guaranteed limits.

Note 10: Human body model, $1.5 \text{ k}\Omega$ in series with 100 pF .

Note 11: Absolute Maximum Ratings indicate limits beyond which damage to the device may occur. Operating ratings indicate conditions for which the device is functional, but do not guarantee specific performance limits. Electrical Characteristics state DC and AC electrical specifications under particular test conditions which guarantee specific performance limits. This assumes that the device is within the Operating Ratings. Specifications are not guaranteed for parameters where no limit is given, however, the typical value is a good indication of device performance.

Typical Performance Characteristics

Input Bias Current

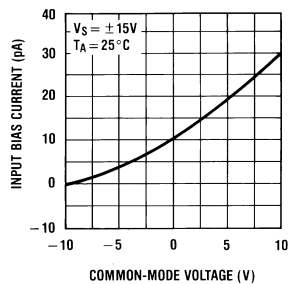

Input Bias Current

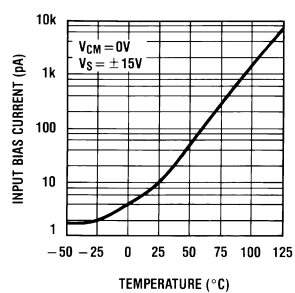

Supply Current

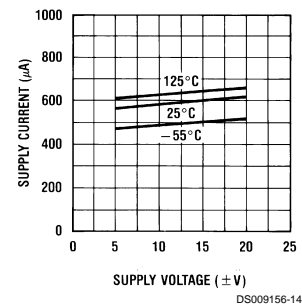

Typical Performance Characteristics (Continued)

Positive Common-Mode Input Voltage Limit

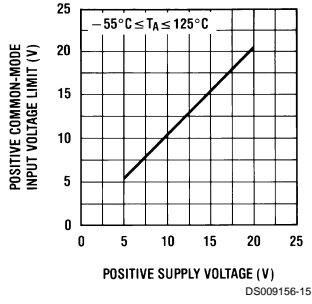

Negative Common-Mode Input Voltage Limit

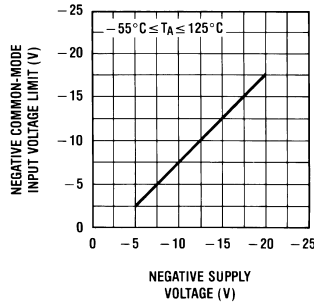

Positive Current Limit

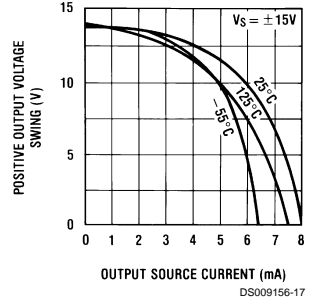

Negative Current Limit

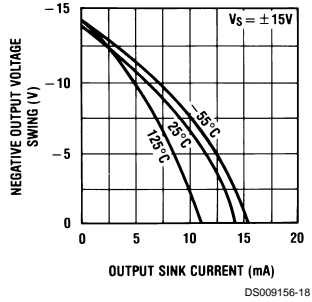

Output Voltage Swing

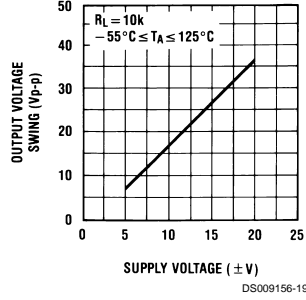

Output Voltage Swing

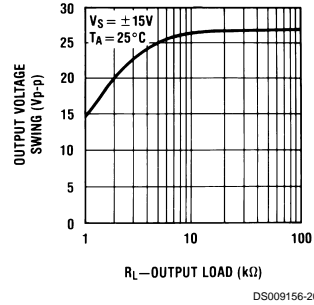

Gain Bandwidth

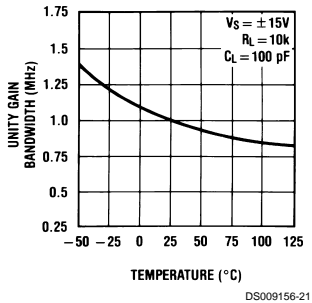

Bode Plot

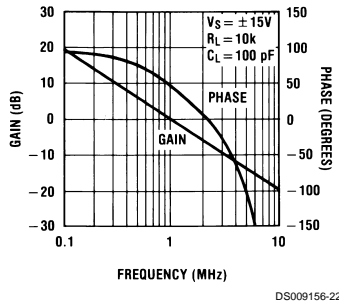

Slew Rate

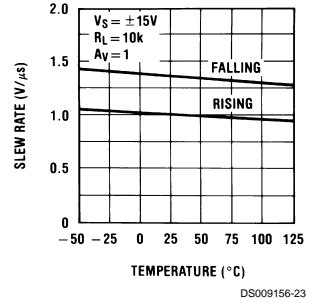

Typical Performance Characteristics (Continued)

Distortion vs Frequency

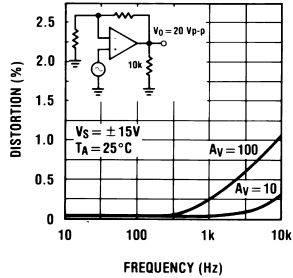

DS009156-24

Undistorted Output Voltage Swing

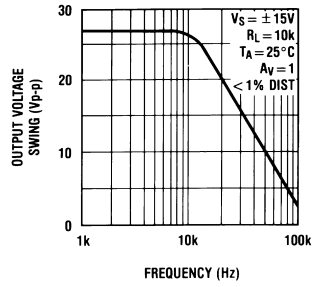

DS009156-25

Open Loop Frequency Response

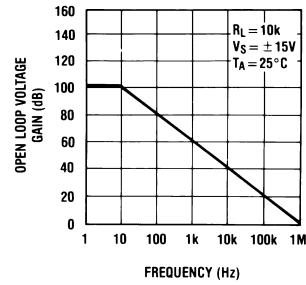

DS009156-26

Common-Mode Rejection Ratio

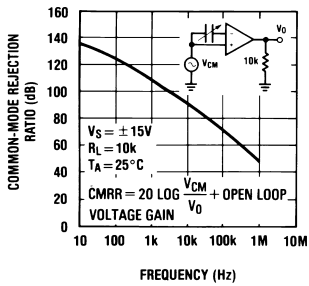

DS009156-27

Power Supply Rejection Ratio

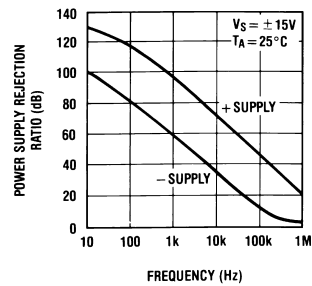

DS009156-28

Equivalent Input Noise Voltage

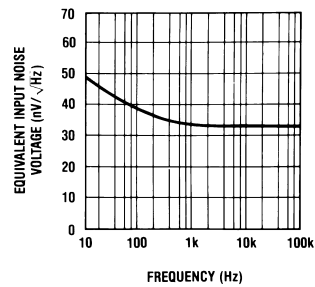

DS009156-29

Open Loop Voltage Gain

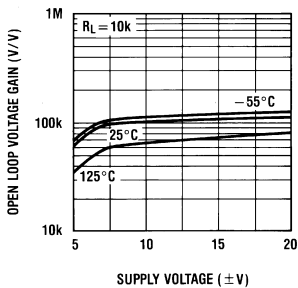

DS009156-30

Output Impedance

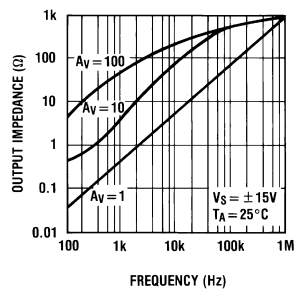

DS009156-31

Inverter Settling Time

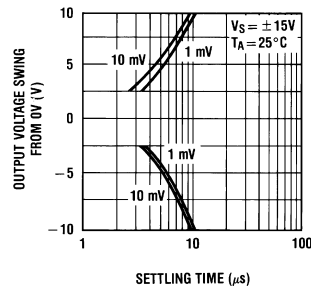

DS009156-32

Pulse Response $R_L = 10\text{ k}\Omega$, $C_L = 10\text{ pF}$

Small Signal Inverting

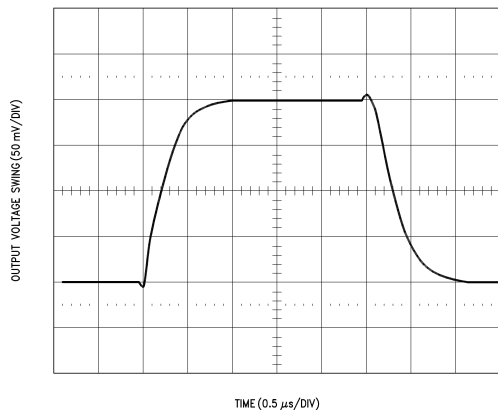

Small Signal Non-Inverting

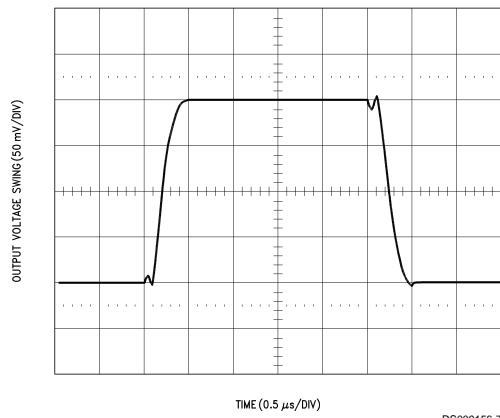

Large Signal Inverting

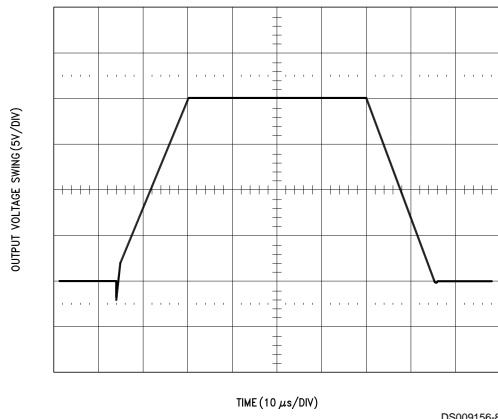

Large Signal Non-Inverting

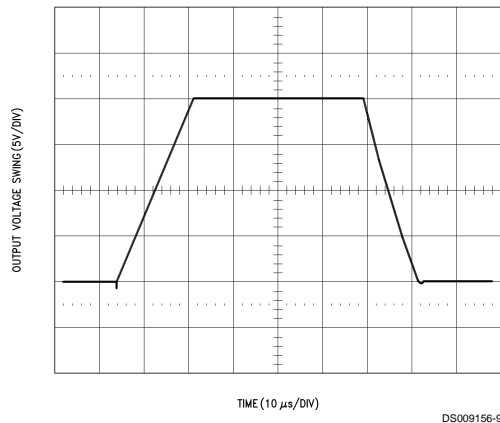

Application Hints

This device is a quad low power op amp with JFET input devices (BI-FET™). These JFETs have large reverse breakdown voltages from gate to source and drain eliminating the need for clamps across the inputs. Therefore, large differential input voltages can easily be accommodated without a large increase in input current. The maximum differential input voltage is independent of the supply voltages. However, neither of the input voltages should be allowed to exceed the negative supply as this will cause large currents to flow which can result in a destroyed unit.

Exceeding the negative common-mode limit on either input will force the output to a high state, potentially causing a reversal of phase to the output. Exceeding the negative common-mode limit on both inputs will force the amplifier output to a high state. In neither case does a latch occur since raising the input back within the common-mode range again puts the input stage and thus the amplifier in a normal operating mode.

Exceeding the positive common-mode limit on a single input will not change the phase of the output; however, if both inputs exceed the limit, the output of the amplifier will be forced to a high state.

The amplifiers will operate with a common-mode input voltage equal to the positive supply; however, the gain bandwidth and slew rate may be decreased in this condition. When the negative common-mode voltage swings to within 3V of the negative supply, an increase in input offset voltage may occur.

Each amplifier is individually biased to allow normal circuit operation with power supplies of $\pm 3.0\text{V}$. Supply voltages less than these may degrade the common-mode rejection and restrict the output voltage swing.

The amplifiers will drive a $10\text{ k}\Omega$ load resistance to $\pm 10\text{V}$ over the full temperature range. If the amplifier is forced to drive heavier load currents, however, an increase in input offset voltage may occur on the negative voltage swing and finally reach an active current limit on both positive and negative swings.

Detailed Schematic

1/4 Quad

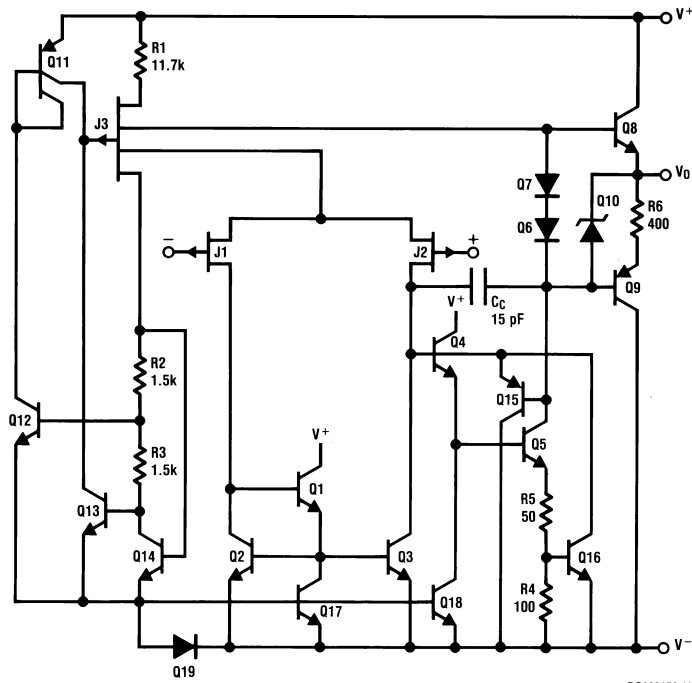

DS009156-11

Physical Dimensions inches (millimeters) unless otherwise noted

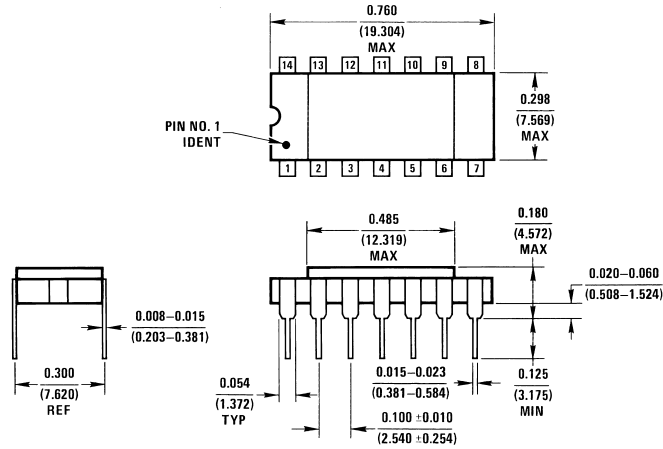

D14E (REV E)

Order Number LF444AMD or LF444MD/883
See NS Package Number D14E

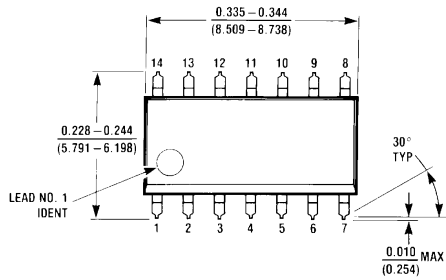

M14A (REV H)

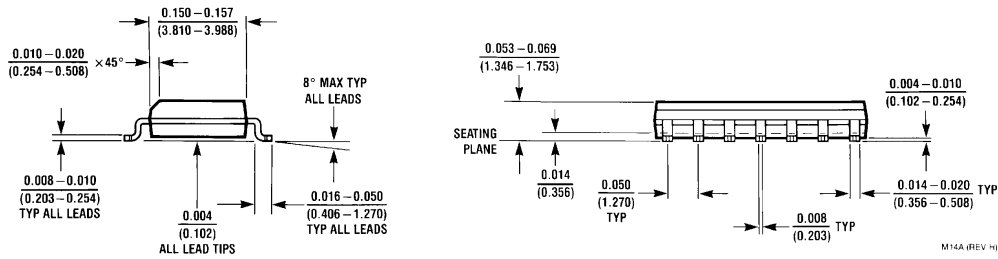

Order Number LF444CM
See NS Package Number M14A

Physical Dimensions inches (millimeters) unless otherwise noted (Continued)

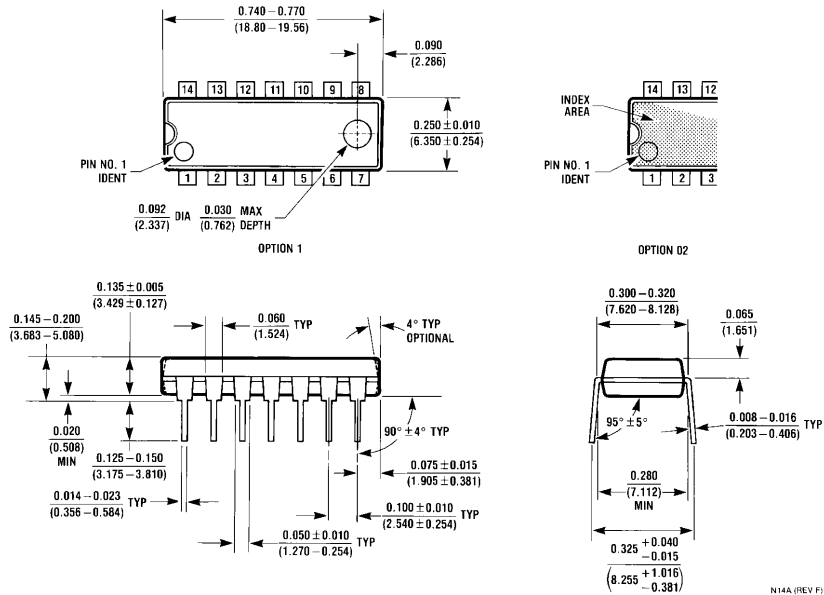

Order Number LF444ACN or LF444CN
See NS Package Number N14A

LIFE SUPPORT POLICY

NATIONAL'S PRODUCTS ARE NOT AUTHORIZED FOR USE AS CRITICAL COMPONENTS IN LIFE SUPPORT DEVICES OR SYSTEMS WITHOUT THE EXPRESS WRITTEN APPROVAL OF THE PRESIDENT OF NATIONAL SEMICONDUCTOR CORPORATION. As used herein:

1. Life support devices or systems are devices or systems which, (a) are intended for surgical implant into the body, or (b) support or sustain life, and whose failure to perform when properly used in accordance with instructions for use provided in the labeling, can be reasonably expected to result in a significant injury to the user.
2. A critical component is any component of a life support device or system whose failure to perform can be reasonably expected to cause the failure of the life support device or system, or to affect its safety or effectiveness.

National Semiconductor Corporation
Americas
Tel: 1-800-272-9959
Fax: 1-800-737-7018
Email: support@nsc.com
www.national.com

National Semiconductor Europe
Fax: +49 (0) 1 80-530 85 86
Email: europe.support@nsc.com
Deutsch Tel: +49 (0) 1 80-530 85 85
English Tel: +49 (0) 1 80-532 78 32
Français Tel: +49 (0) 1 80-532 93 58
Italiano Tel: +49 (0) 1 80-534 16 80

National Semiconductor Asia Pacific Customer Response Group
Tel: 65-2544466
Fax: 65-2504466
Email: sea.support@nsc.com

National Semiconductor Japan Ltd.
Tel: 81-3-5639-7560
Fax: 81-3-5639-7507