



May 2005

LM94022

1.5V, SC70, Multi-Gain Analog Temperature Sensor with Class-AB Output

General Description

The LM94022 is a precision analog output CMOS integrated-circuit temperature sensor that operates at a supply voltage as low as 1.5 Volts. A class-AB output structure gives the LM94022 strong output source and sink current capability for driving heavy loads. For example, it is well suited to source the input of a sample-and-hold analog-to-digital converter with its transient load requirements. While operating over the wide temperature range of -50°C to $+150^{\circ}\text{C}$, the LM94022 delivers an output voltage that is inversely proportional to measured temperature. The LM94022's low supply current makes it ideal for battery-powered systems as well as general temperature sensing applications.

Two logic inputs, Gain Select 1 (GS1) and Gain Select 0 (GS0), select the gain of the temperature-to-voltage output transfer function. Four slopes are selectable: $-5.5\text{ mV}/^{\circ}\text{C}$, $-8.2\text{ mV}/^{\circ}\text{C}$, $-10.9\text{ mV}/^{\circ}\text{C}$, and $-13.6\text{ mV}/^{\circ}\text{C}$. In the lowest gain configuration (GS1 and GS0 both tied low), the LM94022 can operate with a 1.5V supply while measuring temperature over the full -50°C to $+150^{\circ}\text{C}$ operating range. Tying both inputs high causes the transfer function to have the largest gain of $-13.6\text{ mV}/^{\circ}\text{C}$ for maximum temperature sensitivity. The gain-select inputs can be tied directly to V_{DD} or Ground without any pull-up or pull-down resistors, reducing component count and board area. These inputs can also be driven by logic signals allowing the system to optimize the gain during operation or system diagnostics.

Applications

- Cell phones
- Wireless Transceivers

- Battery Management
- Automotive
- Disk Drives
- Games
- Appliances

Features

- Low 1.5V operation
- Push-pull output with $50\mu\text{A}$ source current capability
- Four selectable gains
- Very accurate over wide temperature range of -50°C to $+150^{\circ}\text{C}$
- Low quiescent current
- Output is short-circuit protected
- Extremely small SC70 package
- Footprint compatible with the industry-standard LM20 temperature sensor

Key Specifications

■ Supply Voltage	1.5V to 5.5V								
■ Supply Current	5.4 μA (typ)								
■ Output Drive	$\pm 50\mu\text{A}$								
■ Temperature Accuracy	<table border="0"> <tr> <td>20$^{\circ}\text{C}$ to 40$^{\circ}\text{C}$</td> <td>$\pm 1.5^{\circ}\text{C}$</td> </tr> <tr> <td>-50$^{\circ}\text{C}$ to 70$^{\circ}\text{C}$</td> <td>$\pm 1.8^{\circ}\text{C}$</td> </tr> <tr> <td>-50$^{\circ}\text{C}$ to 90$^{\circ}\text{C}$</td> <td>$\pm 2.1^{\circ}\text{C}$</td> </tr> <tr> <td>-50$^{\circ}\text{C}$ to 150$^{\circ}\text{C}$</td> <td>$\pm 2.7^{\circ}\text{C}$</td> </tr> </table>	20 $^{\circ}\text{C}$ to 40 $^{\circ}\text{C}$	$\pm 1.5^{\circ}\text{C}$	-50 $^{\circ}\text{C}$ to 70 $^{\circ}\text{C}$	$\pm 1.8^{\circ}\text{C}$	-50 $^{\circ}\text{C}$ to 90 $^{\circ}\text{C}$	$\pm 2.1^{\circ}\text{C}$	-50 $^{\circ}\text{C}$ to 150 $^{\circ}\text{C}$	$\pm 2.7^{\circ}\text{C}$
20 $^{\circ}\text{C}$ to 40 $^{\circ}\text{C}$	$\pm 1.5^{\circ}\text{C}$								
-50 $^{\circ}\text{C}$ to 70 $^{\circ}\text{C}$	$\pm 1.8^{\circ}\text{C}$								
-50 $^{\circ}\text{C}$ to 90 $^{\circ}\text{C}$	$\pm 2.1^{\circ}\text{C}$								
-50 $^{\circ}\text{C}$ to 150 $^{\circ}\text{C}$	$\pm 2.7^{\circ}\text{C}$								
■ Operating Temperature	-50°C to 150°C								

Connection Diagram

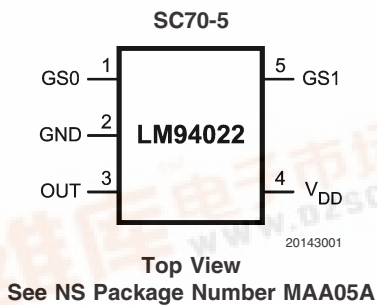

Typical Transfer Characteristic

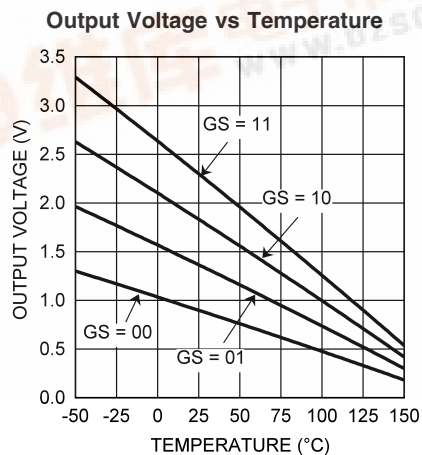

LM94022 1.5V, SC70, Multi-Gain Analog Temperature Sensor with Class-AB Output



Typical Application

Full-Range Celsius Temperature Sensor (-50°C to $+150^{\circ}\text{C}$)
Operating from a Single Battery Cell

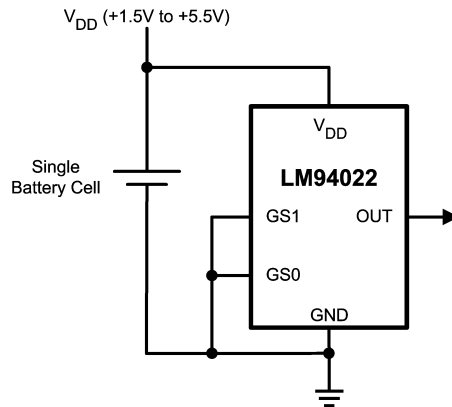

20143002

Ordering Information

Order Number	Temperature Accuracy	NS Package Number	Device Marking	Transport Media
LM94022BIMG	$\pm 1.5^{\circ}\text{C}$ to $\pm 2.7^{\circ}\text{C}$	MAA05A	22B	3000 Units on Tape and Reel
LM94022BIMGX	$\pm 1.5^{\circ}\text{C}$ to $\pm 2.7^{\circ}\text{C}$	MAA05A	22B	9000 Units on Tape and Reel

Pin Descriptions

Label	Pin Number	Type	Equivalent Circuit	Function
GS1	5	Logic Input		Gain Select 1 - One of two inputs for selecting the slope of the output response
GS0	1	Logic Input		Gain Select 0 - One of two inputs for selecting the slope of the output response
OUT	3	Analog Output		Outputs a voltage which is inversely proportional to temperature
V _{DD}	4	Power		Positive Supply Voltage
GND	2	Ground		Power Supply Ground

Absolute Maximum Ratings (Note 1)

Supply Voltage	-0.2V to +6.0V
Voltage at Output Pin	-0.2V to ($V_{DD} + 0.5V$)
Output Current	± 7 mA
Voltage at GS0 and GS1 Input Pins	-0.2V to +6.0V
Input Current at any pin (Note 2)	5 mA
Storage Temperature	-65°C to +150°C
Maximum Junction Temperature (T_{JMAX})	+150°C
ESD Susceptibility (Note 3) : Human Body Model	2500V

Machine Model

250V

Soldering process must comply with National's Reflow Temperature Profile specifications. Refer to www.national.com/packaging. (Note 4)

Operating Ratings(Note 1)

Specified Temperature Range:	$T_{MIN} \leq T_A \leq T_{MAX}$
LM94022	-50°C $\leq T_A \leq$ +150°C
Supply Voltage Range (V_{DD})	+1.5 V to +5.5 V
Thermal Resistance (θ_{JA}) (Note 5)	
SC-70	415°C/W

Accuracy Characteristics

These limits do not include DC load regulation. These stated accuracy limits are with reference to the values in the LM94022 Transfer Table.

Parameter	Conditions	Limits (Note 7)	Units (Limit)	
Temperature Error (Note 8)	GS1=0 GS0=0	$T_A = +20^\circ\text{C}$ to $+40^\circ\text{C}$; $V_{DD} = 1.5V$ to $5.5V$	± 1.5	°C (max)
		$T_A = +0^\circ\text{C}$ to $+70^\circ\text{C}$; $V_{DD} = 1.5V$ to $5.5V$	± 1.8	°C (max)
		$T_A = +0^\circ\text{C}$ to $+90^\circ\text{C}$; $V_{DD} = 1.5V$ to $5.5V$	± 2.1	°C (max)
		$T_A = +0^\circ\text{C}$ to $+120^\circ\text{C}$; $V_{DD} = 1.5V$ to $5.5V$	± 2.4	°C (max)
		$T_A = +0^\circ\text{C}$ to $+150^\circ\text{C}$; $V_{DD} = 1.5V$ to $5.5V$	± 2.7	°C (max)
		$T_A = -50^\circ\text{C}$ to $+0^\circ\text{C}$; $V_{DD} = 1.6V$ to $5.5V$	± 1.8	°C (max)
	GS1=0 GS0=1	$T_A = +20^\circ\text{C}$ to $+40^\circ\text{C}$; $V_{DD} = 1.8V$ to $5.5V$	± 1.5	°C (max)
		$T_A = +0^\circ\text{C}$ to $+70^\circ\text{C}$; $V_{DD} = 1.9V$ to $5.5V$	± 1.8	°C (max)
		$T_A = +0^\circ\text{C}$ to $+90^\circ\text{C}$; $V_{DD} = 1.9V$ to $5.5V$	± 2.1	°C (max)
		$T_A = +0^\circ\text{C}$ to $+120^\circ\text{C}$; $V_{DD} = 1.9V$ to $5.5V$	± 2.4	°C (max)
		$T_A = +0^\circ\text{C}$ to $+150^\circ\text{C}$; $V_{DD} = 1.9V$ to $5.5V$	± 2.7	°C (max)
		$T_A = -50^\circ\text{C}$ to $+0^\circ\text{C}$; $V_{DD} = 2.3V$ to $5.5V$	± 1.8	°C (max)
	GS1=1 GS0=0	$T_A = +20^\circ\text{C}$ to $+40^\circ\text{C}$; $V_{DD} = 2.2V$ to $5.5V$	± 1.5	°C (max)
		$T_A = +0^\circ\text{C}$ to $+70^\circ\text{C}$; $V_{DD} = 2.4V$ to $5.5V$	± 1.8	°C (max)
		$T_A = +0^\circ\text{C}$ to $+90^\circ\text{C}$; $V_{DD} = 2.4V$ to $5.5V$	± 2.1	°C (max)
		$T_A = +0^\circ\text{C}$ to $+120^\circ\text{C}$; $V_{DD} = 2.4V$ to $5.5V$	± 2.4	°C (max)
		$T_A = +0^\circ\text{C}$ to $+150^\circ\text{C}$; $V_{DD} = 2.4V$ to $5.5V$	± 2.7	°C (max)
		$T_A = -50^\circ\text{C}$ to $+0^\circ\text{C}$; $V_{DD} = 3.0V$ to $5.5V$	± 1.8	°C (max)
	GS1=1 GS0=1	$T_A = +20^\circ\text{C}$ to $+40^\circ\text{C}$; $V_{DD} = 2.7V$ to $5.5V$	± 1.5	°C (max)
		$T_A = +0^\circ\text{C}$ to $+70^\circ\text{C}$; $V_{DD} = 3.0V$ to $5.5V$	± 1.8	°C (max)
		$T_A = +0^\circ\text{C}$ to $+90^\circ\text{C}$; $V_{DD} = 3.0V$ to $5.5V$	± 2.1	°C (max)
		$T_A = +0^\circ\text{C}$ to $+120^\circ\text{C}$; $V_{DD} = 3.0V$ to $5.5V$	± 2.4	°C (max)
		$T_A = 0^\circ\text{C}$ to $+150^\circ\text{C}$; $V_{DD} = 3.0V$ to $5.5V$	± 2.7	°C (max)
		$T_A = -50^\circ\text{C}$ to $+0^\circ\text{C}$; $V_{DD} = 3.6V$ to $5.5V$	± 1.8	°C (max)

Electrical Characteristics

Unless otherwise noted, these specifications apply for $V_{DD} = +1.5V$ to $+5.5V$. **Boldface limits apply for $T_A = T_J = T_{MIN}$ to T_{MAX}** ; all other limits $T_A = T_J = 25^\circ C$.

Symbol	Parameter	Conditions	Typical (Note 6)	Limits (Note 7)	Units (Limit)
	Sensor Gain	GS1 = 0, GS0 = 0	-5.5		mV/°C
		GS1 = 0, GS1 = 1	-8.2		mV/°C
		GS1 = 1, GS0 = 0	-10.9		mV/°C
		GS1 = 1, GS0 = 1	-13.6		mV/°C
	Load Regulation (Note 10)	Source $\leq 50 \mu A$, ($V_{DD} - V_{OUT}$) $\geq 200mV$	-0.22	-1	mV (max)
		Sink $\leq 50 \mu A$, ($V_{DD} - V_{OUT}$) $\geq 200mV$	0.26	1	mV (max)
	Line Regulation (Note 13)		200		$\mu V/V$
I_S	Supply Current	$T_A = +30^\circ C$ to $+150^\circ C$, ($V_{DD} - V_{OUT}$) $\geq 100mV$	5.4	8.1	μA (max)
		$T_A = -50^\circ C$ to $+150^\circ C$, ($V_{DD} - V_{OUT}$) $\geq 100mV$	5.4	9	μA (max)
C_L	Output Load Capacitance		1100		pF (max)
	Power-on Time (Note 11)	$C_L = 0$ pF	0.7	5	ms (max)
		$C_L = 1100$ pF	0.8	10	ms (max)
V_{IH}	GS1 and GS0 Input Logic "1" Threshold Voltage			$V_{DD} - 0.5V$	V (min)
V_{IL}	GS1 and GS0 Input Logic "0" Threshold Voltage			0.5	V (max)
I_{IH}	Logic "1" Input Current (Note 12)		0.001	1	μA (max)
I_{IL}	Logic "0" Input Current (Note 12)		0.001	1	μA (max)

Note 1: Absolute Maximum Ratings indicate limits beyond which damage to the device may occur. Operating Ratings indicate conditions for which the device is functional, but do not guarantee specific performance limits. For guaranteed specifications and test conditions, see the Electrical Characteristics. The guaranteed specifications apply only for the test conditions listed. Some performance characteristics may degrade when the device is not operated under the listed test conditions.

Note 2: When the input voltage (V_I) at any pin exceeds power supplies ($V_I < GND$ or $V_I > V^+$), the current at that pin should be limited to 5 mA.

Note 3: The human body model is a 100 pF capacitor discharged through a 1.5 k Ω resistor into each pin. The machine model is a 200 pF capacitor discharged directly into each pin.

Note 4: Reflow temperature profiles are different for lead-free and non-lead-free packages.

Note 5: The junction to ambient thermal resistance (θ_{JA}) is specified without a heat sink in still air.

Note 6: Typical values are at $T_J = T_A = 25^\circ C$ and represent most likely parametric norm.

Note 7: Limits are guaranteed to National's AOQL (Average Outgoing Quality Level).

Note 8: Accuracy is defined as the error between the measured and reference output voltages, tabulated in the Transfer Table at the specified conditions of supply gain setting, voltage, and temperature (expressed in °C). Accuracy limits include line regulation within the specified conditions. Accuracy limits do not include load regulation; they assume no DC load.

Note 9: Changes in output due to self heating can be computed by multiplying the internal dissipation by the thermal resistance.

Note 10: Source currents are flowing out of the LM94022. Sink currents are flowing into the LM94022.

Note 11: Guaranteed by design.

Note 12: The input current is leakage only and is highest at high temperature. It is typically only 0.001 μA . The 1 μA limit is solely based on a testing limitation and does not reflect the actual performance of the part.

Note 13: Line regulation (DC) is calculated by subtracting the output voltage at the highest supply voltage from the output voltage at the lowest supply voltage. The typical DC line regulation specification does not include the output voltage shift discussed in Section 5.0.

Typical Performance Characteristics

Temperature Error vs. Temperature

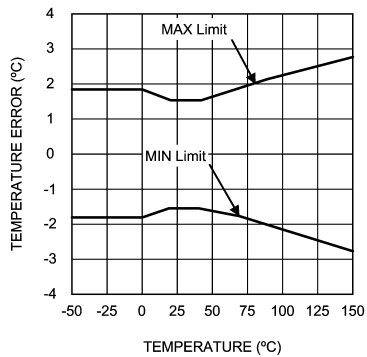

20143007

Minimum Operating Temperature vs. Supply Voltage

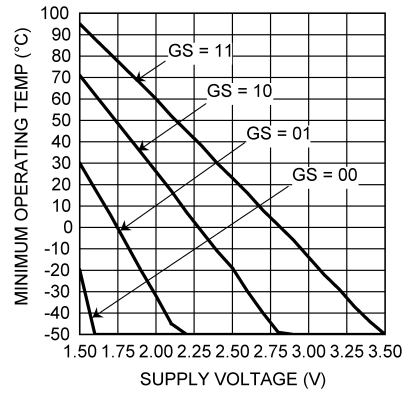

20143006

Supply Current vs. Temperature

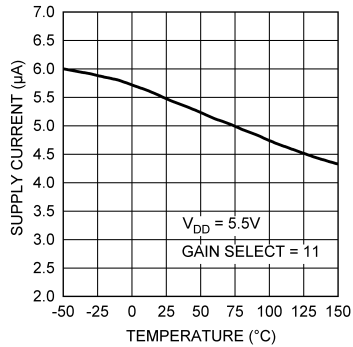

20143004

Supply Current vs. Supply Voltage

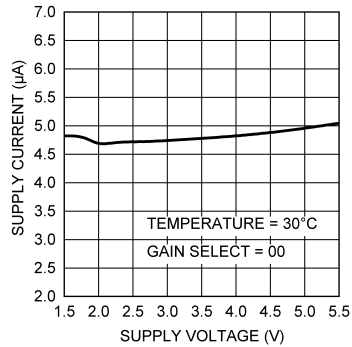

20143005

Load Regulation, Sourcing Current

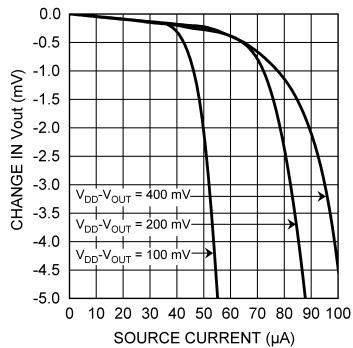

20143040

Load Regulation, Sinking Current

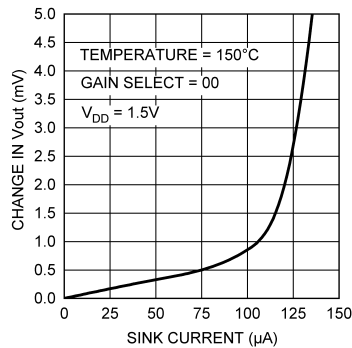

20143041

Typical Performance Characteristics (Continued)

Change in Vout vs. Overhead Voltage

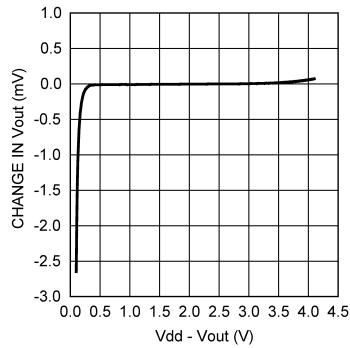

20143042

Supply-Noise Gain vs. Frequency

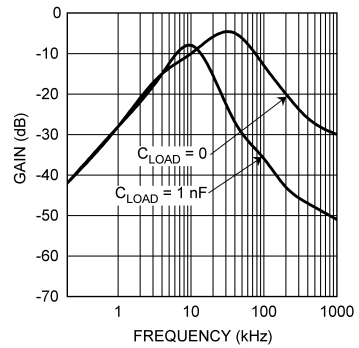

20143043

**Output Voltage vs. Supply Voltage
Gain Select = 00**

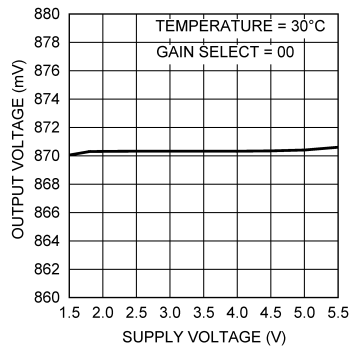

20143034

**Output Voltage vs. Supply Voltage
Gain Select = 01**

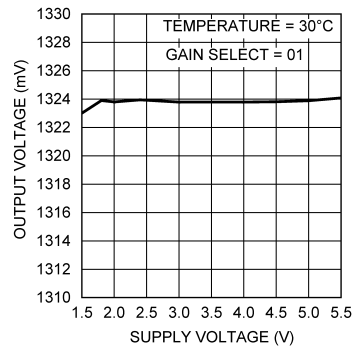

20143035

**Output Voltage vs. Supply Voltage
Gain Select = 10**

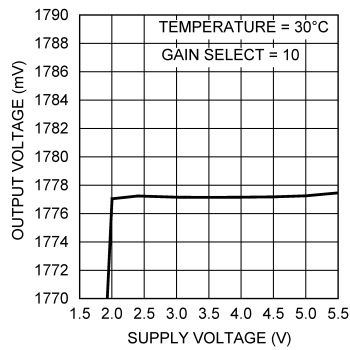

20143036

**Output Voltage vs. Supply Voltage
Gain Select = 11**

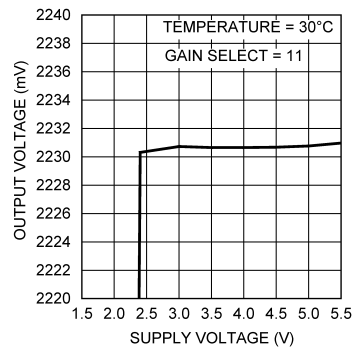

20143037

1.0 LM94022 Transfer Function

The LM94022 has four selectable gains, each of which can be selected by the GS1 and GS0 input pins. The output voltage for each gain, across the complete operating temperature range is shown in the LM94022 Transfer Table, below. This table is the reference from which the LM94022 accuracy specifications (listed in the Electrical Characteristics section) are determined. This table can be used, for example, in a host processor look-up table. A file containing this data is available for download at www.national.com/appinfo/tempsensors.

LM94022 Transfer Table

The output voltages in this table apply for $V_{DD} = 5V$.

Temperature (°C)	GS = 00 (mV)	GS = 01 (mV)	GS = 10 (mV)	GS = 11 (mV)
-50	1299	1955	2616	3277
-49	1294	1949	2607	3266
-48	1289	1942	2598	3254
-47	1284	1935	2589	3243
-46	1278	1928	2580	3232
-45	1273	1921	2571	3221
-44	1268	1915	2562	3210
-43	1263	1908	2553	3199
-42	1257	1900	2543	3186
-41	1252	1892	2533	3173
-40	1247	1885	2522	3160
-39	1242	1877	2512	3147
-38	1236	1869	2501	3134
-37	1231	1861	2491	3121
-36	1226	1853	2481	3108
-35	1221	1845	2470	3095
-34	1215	1838	2460	3082
-33	1210	1830	2449	3069
-32	1205	1822	2439	3056
-31	1200	1814	2429	3043
-30	1194	1806	2418	3030
-29	1189	1798	2408	3017
-28	1184	1790	2397	3004
-27	1178	1783	2387	2991
-26	1173	1775	2376	2978
-25	1168	1767	2366	2965
-24	1162	1759	2355	2952
-23	1157	1751	2345	2938
-22	1152	1743	2334	2925
-21	1146	1735	2324	2912
-20	1141	1727	2313	2899
-19	1136	1719	2302	2886
-18	1130	1711	2292	2873
-17	1125	1703	2281	2859
-16	1120	1695	2271	2846
-15	1114	1687	2260	2833
-14	1109	1679	2250	2820

The output voltages in this table apply for $V_{DD} = 5V$.

Temperature (°C)	GS = 00 (mV)	GS = 01 (mV)	GS = 10 (mV)	GS = 11 (mV)
-13	1104	1671	2239	2807
-12	1098	1663	2228	2793
-11	1093	1656	2218	2780
-10	1088	1648	2207	2767
-9	1082	1639	2197	2754
-8	1077	1631	2186	2740
-7	1072	1623	2175	2727
-6	1066	1615	2164	2714
-5	1061	1607	2154	2700
-4	1055	1599	2143	2687
-3	1050	1591	2132	2674
-2	1044	1583	2122	2660
-1	1039	1575	2111	2647
0	1034	1567	2100	2633
1	1028	1559	2089	2620
2	1023	1551	2079	2607
3	1017	1543	2068	2593
4	1012	1535	2057	2580
5	1007	1527	2047	2567
6	1001	1519	2036	2553
7	996	1511	2025	2540
8	990	1502	2014	2527
9	985	1494	2004	2513
10	980	1486	1993	2500
11	974	1478	1982	2486
12	969	1470	1971	2473
13	963	1462	1961	2459
14	958	1454	1950	2446
15	952	1446	1939	2433
16	947	1438	1928	2419
17	941	1430	1918	2406
18	936	1421	1907	2392
19	931	1413	1896	2379
20	925	1405	1885	2365
21	920	1397	1874	2352
22	914	1389	1864	2338
23	909	1381	1853	2325
24	903	1373	1842	2311
25	898	1365	1831	2298
26	892	1356	1820	2285
27	887	1348	1810	2271
28	882	1340	1799	2258
29	876	1332	1788	2244
30	871	1324	1777	2231
31	865	1316	1766	2217
32	860	1308	1756	2204
33	854	1299	1745	2190
34	849	1291	1734	2176
35	843	1283	1723	2163

1.0 LM94022 Transfer Function

(Continued)

LM94022 Transfer Table (Continued)

The output voltages in this table apply for $V_{DD} = 5V$.

Temperature (°C)	GS = 00 (mV)	GS = 01 (mV)	GS = 10 (mV)	GS = 11 (mV)
36	838	1275	1712	2149
37	832	1267	1701	2136
38	827	1258	1690	2122
39	821	1250	1679	2108
40	816	1242	1668	2095
41	810	1234	1657	2081
42	804	1225	1646	2067
43	799	1217	1635	2054
44	793	1209	1624	2040
45	788	1201	1613	2026
46	782	1192	1602	2012
47	777	1184	1591	1999
48	771	1176	1580	1985
49	766	1167	1569	1971
50	760	1159	1558	1958
51	754	1151	1547	1944
52	749	1143	1536	1930
53	743	1134	1525	1916
54	738	1126	1514	1902
55	732	1118	1503	1888
56	726	1109	1492	1875
57	721	1101	1481	1861
58	715	1093	1470	1847
59	710	1084	1459	1833
60	704	1076	1448	1819
61	698	1067	1436	1805
62	693	1059	1425	1791
63	687	1051	1414	1777
64	681	1042	1403	1763
65	676	1034	1391	1749
66	670	1025	1380	1735
67	664	1017	1369	1721
68	659	1008	1358	1707
69	653	1000	1346	1693
70	647	991	1335	1679
71	642	983	1324	1665
72	636	974	1313	1651
73	630	966	1301	1637
74	625	957	1290	1623
75	619	949	1279	1609
76	613	941	1268	1595
77	608	932	1257	1581
78	602	924	1245	1567
79	596	915	1234	1553
80	591	907	1223	1539

The output voltages in this table apply for $V_{DD} = 5V$.

Temperature (°C)	GS = 00 (mV)	GS = 01 (mV)	GS = 10 (mV)	GS = 11 (mV)
81	585	898	1212	1525
82	579	890	1201	1511
83	574	881	1189	1497
84	568	873	1178	1483
85	562	865	1167	1469
86	557	856	1155	1455
87	551	848	1144	1441
88	545	839	1133	1427
89	539	831	1122	1413
90	534	822	1110	1399
91	528	814	1099	1385
92	522	805	1088	1371
93	517	797	1076	1356
94	511	788	1065	1342
95	505	779	1054	1328
96	499	771	1042	1314
97	494	762	1031	1300
98	488	754	1020	1286
99	482	745	1008	1272
100	476	737	997	1257
101	471	728	986	1243
102	465	720	974	1229
103	459	711	963	1215
104	453	702	951	1201
105	448	694	940	1186
106	442	685	929	1172
107	436	677	917	1158
108	430	668	906	1144
109	425	660	895	1130
110	419	651	883	1115
111	413	642	872	1101
112	407	634	860	1087
113	401	625	849	1073
114	396	617	837	1058
115	390	608	826	1044
116	384	599	814	1030
117	378	591	803	1015
118	372	582	791	1001
119	367	573	780	987
120	361	565	769	973
121	355	556	757	958
122	349	547	745	944
123	343	539	734	929
124	337	530	722	915
125	332	521	711	901
126	326	513	699	886
127	320	504	688	872
128	314	495	676	858
129	308	487	665	843

1.0 LM94022 Transfer Function

(Continued)

LM94022 Transfer Table (Continued)

The output voltages in this table apply for $V_{DD} = 5V$.

Temperature (°C)	GS = 00 (mV)	GS = 01 (mV)	GS = 10 (mV)	GS = 11 (mV)
130	302	478	653	829
131	296	469	642	814
132	291	460	630	800
133	285	452	618	786
134	279	443	607	771
135	273	434	595	757
136	267	425	584	742
137	261	416	572	728
138	255	408	560	713
139	249	399	549	699
140	243	390	537	684
141	237	381	525	670
142	231	372	514	655
143	225	363	502	640
144	219	354	490	626
145	213	346	479	611
146	207	337	467	597
147	201	328	455	582
148	195	319	443	568
149	189	310	432	553
150	183	301	420	538

Although the LM94022 is very linear, its response does have a slight downward parabolic shape. This shape is very accurately reflected in the LM94022 Transfer Table. For a linear approximation, a line can easily be calculated over the desired temperature range from the Table using the two-point equation:

$$V - V_1 = \left(\frac{V_2 - V_1}{T_2 - T_1} \right) \times (T - T_1)$$

Where V is in mV, T is in °C, T_1 and V_1 are the coordinates of the lowest temperature, T_2 and V_2 are the coordinates of the highest temperature.

For example, if we want to determine the equation of a line with the Gain Setting at GS1 = 0 and GS0 = 0, over a temperature range of 20°C to 50°C, we would proceed as follows:

$$V - 925 \text{ mV} = \left(\frac{760 \text{ mV} - 925 \text{ mV}}{50^\circ\text{C} - 20^\circ\text{C}} \right) \times (T - 20^\circ\text{C})$$

$$V - 925 \text{ mV} = (-5.50 \text{ mV} / ^\circ\text{C}) \times (T - 20^\circ\text{C})$$

$$V = (-5.50 \text{ mV} / ^\circ\text{C}) \times T + 1035 \text{ mV}$$

Using this method of linear approximation, the transfer function can be approximated for one or more temperature ranges of interest.

2.0 Mounting and Thermal Conductivity

The LM94022 can be applied easily in the same way as other integrated-circuit temperature sensors. It can be glued or cemented to a surface.

To ensure good thermal conductivity, the backside of the LM94022 die is directly attached to the GND pin (Pin 2). The temperatures of the lands and traces to the other leads of the LM94022 will also affect the temperature reading.

Alternatively, the LM94022 can be mounted inside a sealed-end metal tube, and can then be dipped into a bath or screwed into a threaded hole in a tank. As with any IC, the LM94022 and accompanying wiring and circuits must be kept insulated and dry, to avoid leakage and corrosion. This is especially true if the circuit may operate at cold temperatures where condensation can occur. If moisture creates a short circuit from the output to ground or V_{DD} , the output from the LM94022 will not be correct. Printed-circuit coatings are often used to ensure that moisture cannot corrode the leads or circuit traces.

The thermal resistance junction to ambient (θ_{JA}) is the parameter used to calculate the rise of a device junction temperature due to its power dissipation. The equation used to calculate the rise in the LM94022's die temperature is

$$T_J = T_A + \theta_{JA} \left[(V_{DD} I_Q) + (V_{DD} - V_O) I_L \right]$$

where T_A is the ambient temperature, I_Q is the quiescent current, I_L is the load current on the output, and V_O is the output voltage. For example, in an application where $T_A = 30^\circ\text{C}$, $V_{DD} = 5\text{ V}$, $I_{DD} = 9\ \mu\text{A}$, Gain Select = 11, $V_{OUT} = 2.231\text{ mV}$, and $I_L = 2\ \mu\text{A}$, the junction temperature would be 30.021°C , showing a self-heating error of only 0.021°C . Since the LM94022's junction temperature is the actual temperature being measured, care should be taken to minimize the load current that the LM94022 is required to drive. *Figure 1* shows the thermal resistance of the LM94022.

Device Number	NS Package Number	Thermal Resistance (θ_{JA})
LM94022BIMG	MAA05A	415°C/W

FIGURE 1. LM94022 Thermal Resistance

3.0 Output and Noise Considerations

A push-pull output gives the LM94022 the ability to sink and source significant current. This is beneficial when, for example, driving dynamic loads like an input stage on an analog-to-digital converter (ADC). In these applications the source current is required to quickly charge the input capacitor of the ADC. See the Applications Circuits section for more discussion of this topic. The LM94022 is ideal for this and other applications which require strong source or sink current.

The LM94022's supply-noise gain (the ratio of the AC signal on V_{OUT} to the AC signal on V_{DD}) was measured during bench tests. It's typical attenuation is shown in the Typical Performance Characteristics section. A load capacitor on the output can help to filter noise.

For operation in very noisy environments, some bypass capacitance should be present on the supply within approximately 2 inches of the LM94022.

4.0 Capacitive Loads

The LM94022 handles capacitive loading well. In an extremely noisy environment, or when driving a switched sampling input on an ADC, it may be necessary to add some filtering to minimize noise coupling. Without any precautions, the LM94022 can drive a capacitive load less than or equal to 1100 pF as shown in *Figure 2*. For capacitive loads greater than 1100 pF, a series resistor may be required on the output, as shown in *Figure 3*.

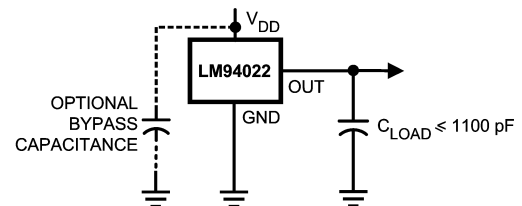

20143015

FIGURE 2. LM94022 No Decoupling Required for Capacitive Loads Less than 1100 pF.

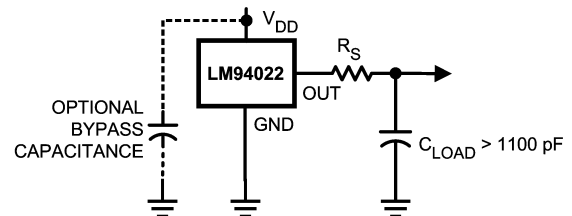

20143033

C_{LOAD}	R_S
1.1 nF to 99 nF	3 k Ω
100 nF to 999 nF	1.5 k Ω
1 μF	800 Ω

FIGURE 3. LM94022 with series resistor for capacitive Loading greater than 1100 pF.

5.0 Output Voltage Shift

The LM94022 is very linear over temperature and supply voltage range. Due to the intrinsic behavior of an NMOS/PMOS rail-to-rail buffer, a slight shift in the output can occur when the supply voltage is ramped over the operating range of the device. The location of the shift is determined by the relative levels of V_{DD} and V_{OUT} . The shift typically occurs when $V_{DD} - V_{OUT} = 1.0\text{V}$.

This slight shift (a few millivolts) takes place over a wide change (approximately 200 mV) in V_{DD} or V_{OUT} . Since the shift takes place over a wide temperature change of 5°C to 20°C , V_{OUT} is always monotonic. The accuracy specifications in the Electrical Characteristics table already include this possible shift.

6.0 Selectable Gain for Optimization and In Situ Testing

The Gain Select digital inputs can be tied to the rails or can be driven from digital outputs such as microcontroller GPIO pins. In low-supply voltage applications, the ability to reduce the gain to $-5.5 \text{ mV}/^\circ\text{C}$ allows the LM94022 to operate over the full -50°C to 150°C range. When a larger supply voltage is present, the gain can be increased as high as $-13.6 \text{ mV}/^\circ\text{C}$. The larger gain is optimal for reducing the effects of

noise (for example, noise coupling on the output line or quantization noise induced by an analog-to-digital converter which may be sampling the LM94022 output).

Another application advantage of the digitally selectable gain is the ability to perform dynamic testing of the LM94022 while it is running in a system. By toggling the logic levels of the gain select pins and monitoring the resultant change in the output voltage level, the host system can verify the functionality of the LM94022.

7.0 Applications Circuits

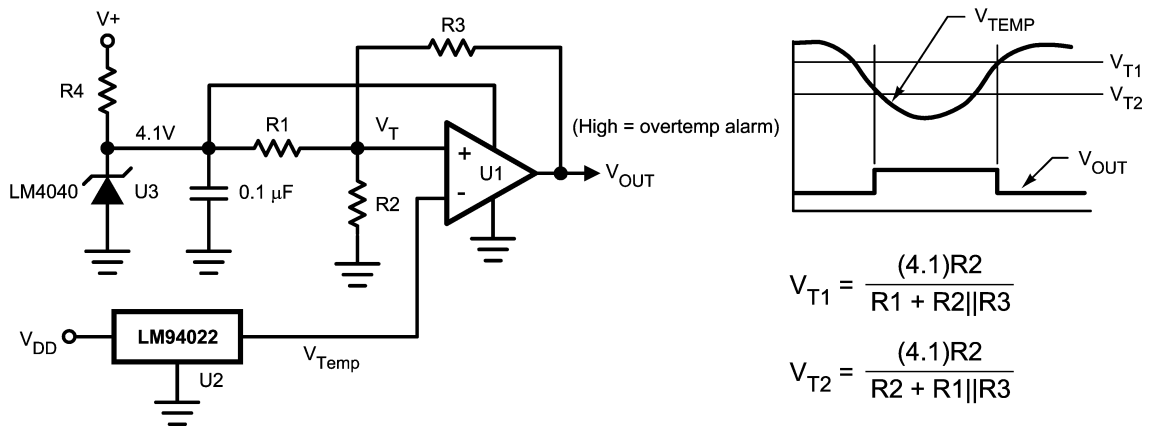

20143018

FIGURE 4. Celsius Thermostat

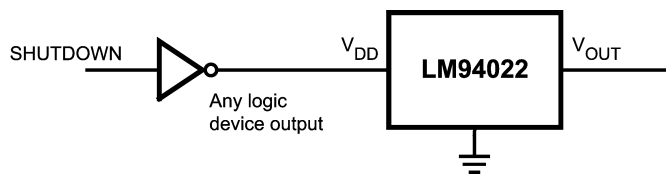

20143019

FIGURE 5. Conserving Power Dissipation with Shutdown

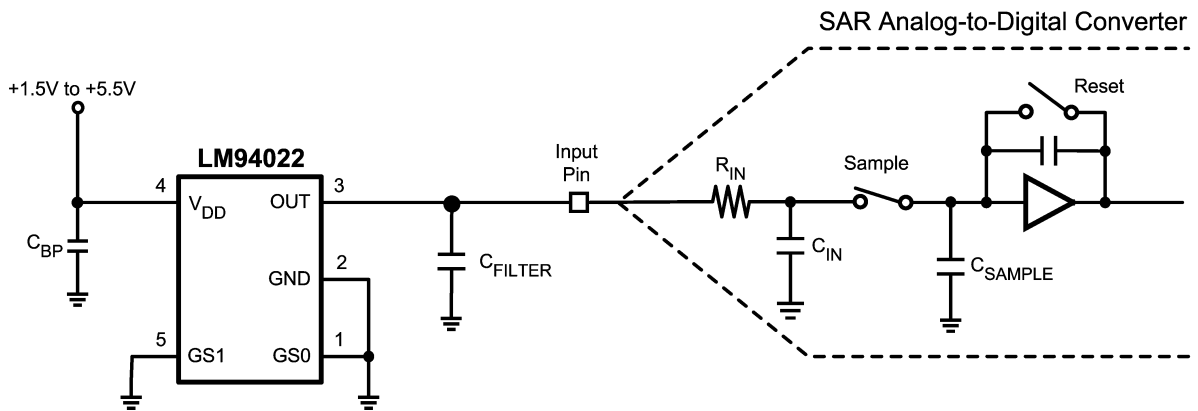

20143028

Most CMOS ADCs found in microcontrollers and ASICs have a sampled data comparator input structure. When the ADC charges the sampling cap, it requires instantaneous charge from the output of the analog source such as the LM94022 temperature sensor and many op amps. This requirement is easily accommodated by the addition of a capacitor (C_{FILTER}). The size of C_{FILTER} depends on the size of the sampling capacitor and the sampling frequency. Since not all ADCs have identical input stages, the charge requirements will vary. This general ADC application is shown as an example only.

FIGURE 6. Suggested Connection to a Sampling Analog-to-Digital Converter Input Stage

Physical Dimensions inches (millimeters) unless otherwise noted

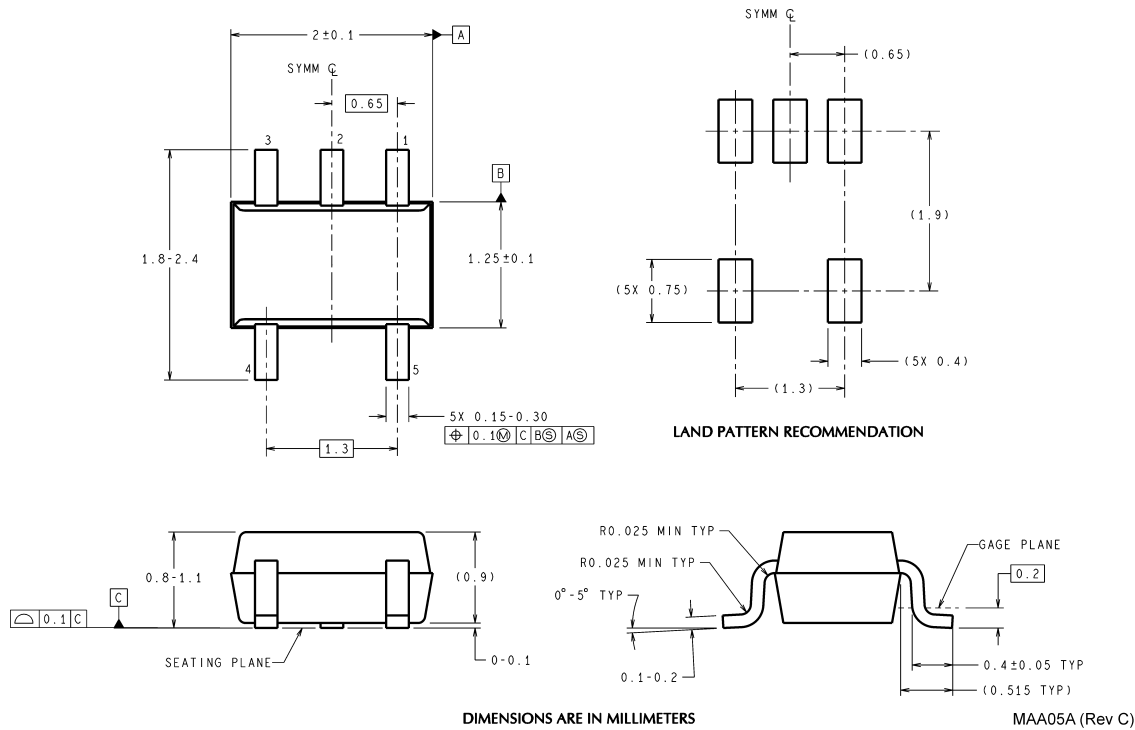

5-Lead SC70 Molded Package
Order Number LM94022BIMG, LM94022BIMGX
NS Package Number MAA05A

National does not assume any responsibility for use of any circuitry described, no circuit patent licenses are implied and National reserves the right at any time without notice to change said circuitry and specifications.

For the most current product information visit us at www.national.com.

LIFE SUPPORT POLICY

NATIONAL'S PRODUCTS ARE NOT AUTHORIZED FOR USE AS CRITICAL COMPONENTS IN LIFE SUPPORT DEVICES OR SYSTEMS WITHOUT THE EXPRESS WRITTEN APPROVAL OF THE PRESIDENT AND GENERAL COUNSEL OF NATIONAL SEMICONDUCTOR CORPORATION. As used herein:

1. Life support devices or systems are devices or systems which, (a) are intended for surgical implant into the body, or (b) support or sustain life, and whose failure to perform when properly used in accordance with instructions for use provided in the labeling, can be reasonably expected to result in a significant injury to the user.
2. A critical component is any component of a life support device or system whose failure to perform can be reasonably expected to cause the failure of the life support device or system, or to affect its safety or effectiveness.

BANNED SUBSTANCE COMPLIANCE

National Semiconductor manufactures products and uses packing materials that meet the provisions of the Customer Products Stewardship Specification (CSP-9-111C2) and the Banned Substances and Materials of Interest Specification (CSP-9-111S2) and contain no "Banned Substances" as defined in CSP-9-111S2.



National Semiconductor
Americas Customer
Support Center
 Email: new.feedback@nsc.com
 Tel: 1-800-272-9959

National Semiconductor
Europe Customer Support Center
 Fax: +49 (0) 180-530 85 86
 Email: europe.support@nsc.com
 Deutsch Tel: +49 (0) 69 9508 6208
 English Tel: +44 (0) 870 24 0 2171
 Français Tel: +33 (0) 1 41 91 8790

National Semiconductor
Asia Pacific Customer
Support Center
 Email: ap.support@nsc.com

National Semiconductor
Japan Customer Support Center
 Fax: 81-3-5639-7507
 Email: jpn.feedback@nsc.com
 Tel: 81-3-5639-7560