

Product Description

Stanford Microdevices' SGA-6489 is a high performance SiGe Heterojunction Bipolar Transistor MMIC Amplifier. A Darlington configuration featuring 1 micron emitters provides high F_T and excellent thermal performance. The heterojunction increases breakdown voltage and minimizes leakage current between junctions. Cancellation of emitter junction non-linearities results in higher suppression of intermodulation products. At 850 MHz and 75mA, the SGA-6489 typically provides +33.4 dBm output IP₃, 20.1 dB of gain, and +20.7 dBm of 1dB compressed power using a single positive voltage supply. Only 2 DC-blocking capacitors, a bias resistor and an optional RF choke are required for operation.

SGA-6489

DC-3500 MHz, Cascadable SiGe HBT MMIC Amplifier

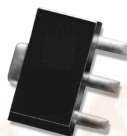

Product Features

- High Gain : 17.5 dB at 1950 MHz
- Cascadable 50 Ohm
- Patented SiGe Technology
- Operates From Single Supply
- Low Thermal Resistance Package

Applications

- Cellular, PCS, CDPD
- Wireless Data, SONET
- Satellite

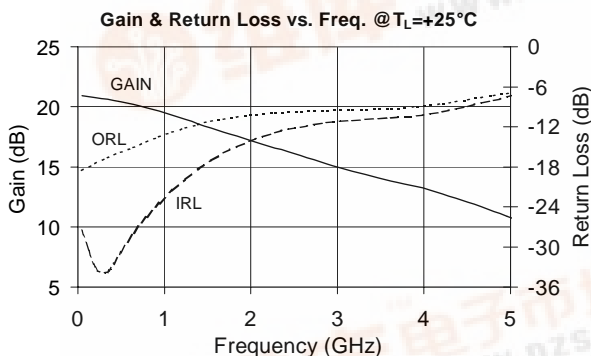

Symbol	Parameter	Units	Frequency	Min.	Typ.	Max.
G	Small Signal Gain	dB	850 MHz	18.4	20.1	22.4
		dB	1950 MHz		17.5	
		dB	2400 MHz		16.5	
P_{1dB}	Output Power at 1dB Compression	dBm	850 MHz		20.7	
		dBm	1950 MHz		18.7	
OIP_3	Output Third Order Intercept Point (Power out per tone = 0dBm)	dBm	850 MHz		33.4	
		dBm	1950 MHz		31.3	
Bandwidth	Determined by Return Loss (<-10dB)	MHz			3500	
IRL	Input Return Loss	dB	1950 MHz		14.4	
ORL	Output Return Loss	dB	1950 MHz		10.4	
NF	Noise Figure	dB	1950 MHz		3.0	
V_D	Device Voltage	V		4.7	5.1	5.5
R_{Th}	Thermal Resistance				97	

Test Conditions:

$V_S = 8\text{ V}$

$I_D = 75\text{ mA Typ.}$

OIP_3 Tone Spacing = 1 MHz, Pout per tone = 0 dBm

$R_{BIAS} = 39\text{ Ohms}$

$T_L = 25^\circ\text{C}$

$Z_S = Z_L = 50\text{ Ohms}$

Typical RF Performance at Key Operating Frequencies

Symbol	Parameter	Unit	Frequency (MHz)					
			100	500	850	1950	2400	3500
G	Small Signal Gain	dB		20.8	20.1	17.5	16.5	
OIP ₃	Output Third Order Intercept Point	dBm		33.5	33.4	31.3	30.1	
P _{1dB}	Output Power at 1dB Compression	dBm		20.9	20.7	18.7	17.4	
IRL	Input Return Loss	dB	29.4	30.8	24.7	14.4	12.5	10.8
ORL	Output Return Loss	dB	18.2	15.8	20.6	10.4	10.0	9.5
S ₁₂	Reverse Isolation	dB	23.9	23.8	23.9	22.2	21.4	19.3
NF	Noise Figure	dB		2.8	2.7	3.0	3.6	

Test Conditions: V_S = 8 V, I_D = 75 mA Typ., OIP₃ Tone Spacing = 1 MHz, P_{out} per tone = 0 dBm
R_{BIAS} = 39 Ohms, T_L = 25°C, Z_S = Z_L = 50 Ohms

Noise Figure vs. Frequency
V_D = 5.1 V, I_D = 75 mA

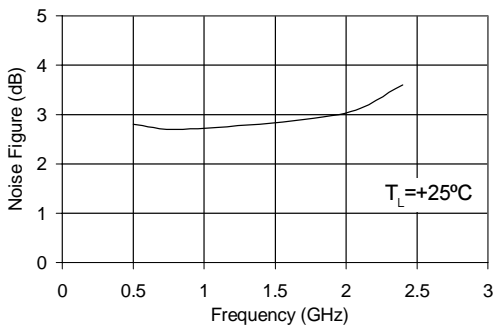

Absolute Maximum Ratings

Parameter	Absolute Limit
Max. Device Current (I _b)	150 mA
Max. Device Voltage (V _D)	7 V
Max. RF Input Power	+10 dBm
Max. Junction Temp. (T _J)	+150°C
Operating Temp. Range (T _L)	-40°C to +85°C
Max. Storage Temp.	+150°C

Operation of this device beyond any one of these limits may cause permanent damage.

Bias Conditions should also satisfy the following expression: I_DV_D (max) < (T_J - T_L)/R_{th}

OIP₃ vs. Frequency
V_D = 5.1 V, I_D = 75 mA

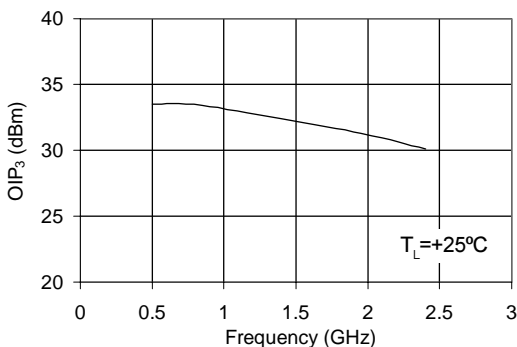

P_{1dB} vs. Frequency
V_D = 5.1 V, I_D = 75 mA

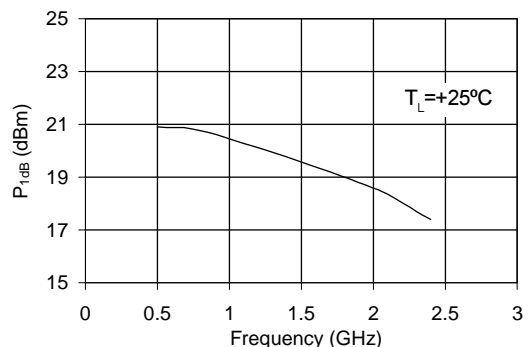

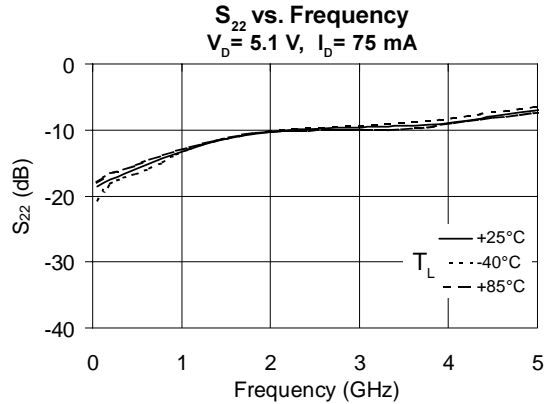
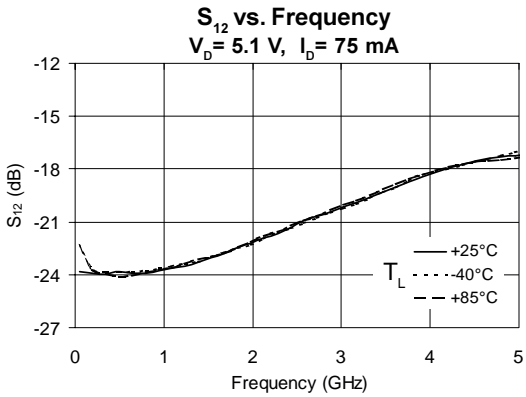
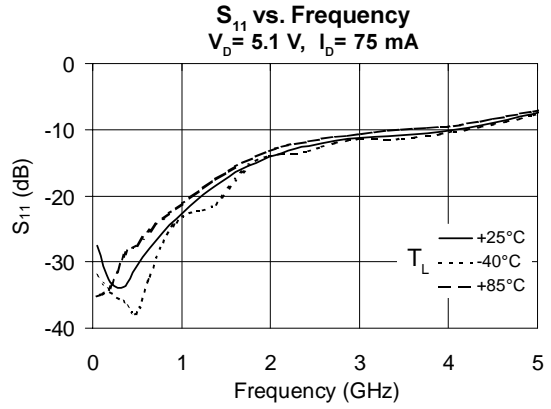
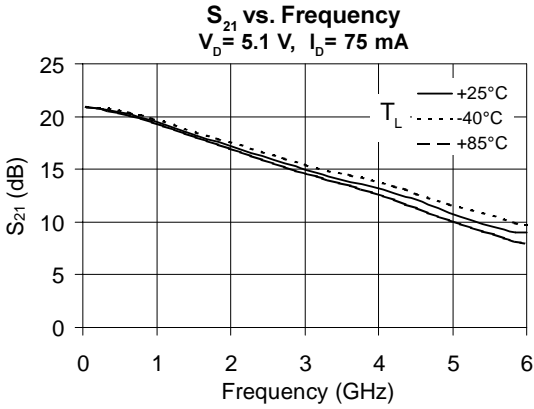

Basic Application Circuit

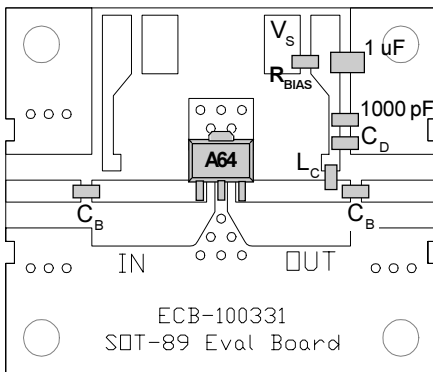
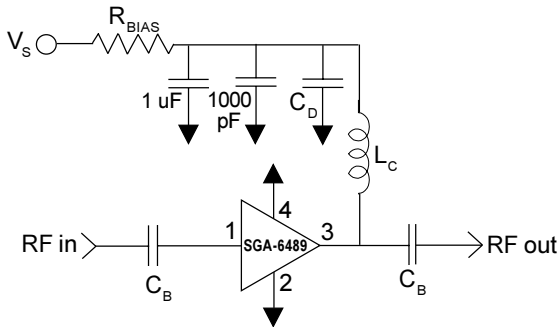

Part Identification Marking

The part will be marked with an "A64" designator on the top surface of the package.

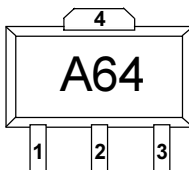

For package dimensions, refer to outline drawing at www.stanfordmicro.com

Application Circuit Element Values

Reference Designator	Frequency (Mhz)				
	500	850	1950	2400	3500
C _B	220 pF	100 pF	68 pF	56 pF	39 pF
C _D	100 pF	68 pF	22 pF	22 pF	15 pF
L _C	68 nH	33 nH	22 nH	18 nH	15 nH

Recommended Bias Resistor Values for Id=75mA

Supply Voltage(V _S)	7.5 V	8 V	10 V	12 V
R _{BIAS}	33 Ω	39 Ω	62 Ω	91 Ω

Note: R_{BIAS} provides DC bias stability over temperature.

Mounting Instructions

1. Solder the copper pad on the backside of the device package to the ground plane.
2. Use a large ground pad area with many plated through-holes as shown.
3. We recommend 1 or 2 ounce copper. Measurement for this data sheet were made on a 31 mil thick FR-4 board with 1 ounce copper on both sides.

Pin #	Function	Description
1	RF IN	RF input pin. This pin requires the use of an external DC blocking capacitor chosen for the frequency of operation.
2	GND	Connection to ground. Use via holes for best performance to reduce lead inductance as close to ground leads as possible.
3	RF OUT/BIAS	RF output and bias pin. DC voltage is present on this pin, therefore a DC blocking capacitor is necessary for proper operation.
4	GND	Same as Pin 2

Part Number Ordering Information

Part Number	Reel Size	Devices/Reel
SGA-6489	7"	1000



Caution: ESD sensitive

Appropriate precautions in handling, packaging and testing devices must be observed.