



TCRT1000/ TCRT1010

Vishay Telefunken

Reflective Optical Sensor with Transistor Output

Description

The TCRT1000/ TCRT1010 have a compact construction where the emitting-light source and the detector are arranged in the same direction to sense the presence of an object by using the reflective IR-beam from the object.

The operating wavelength is 950 nm. The detector consists of a phototransistor.

Applications

- Optoelectronic scanning and switching devices i.e., index sensing, coded disk scanning etc. (optoelectronic encoder assemblies for transmissive sensing).

Features

- Compact construction in spacing of 0.1
- No setting efforts
- High signal outputs
- Low temperature coefficient
- Detector provided with optical filter
- **Current Transfer Ratio (CTR)** of typical 2.5%

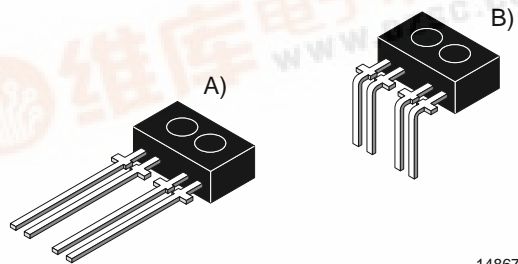

14867

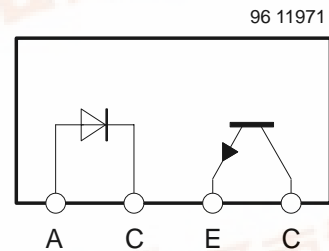

96 11971

Top view

Order Instruction

Ordering Code	Sensing Distance	Remarks
TCRT1000 ^{A)}	1 mm	
TCRT1010 ^{B)}	1 mm	



TCRT1000/ TCRT1010

Vishay Telefunken



Absolute Maximum Ratings

Input (Emitter)

Parameter	Test Conditions	Symbol	Value	Unit
Reverse voltage		V_R	5	V
Forward current		I_F	50	mA
Forward surge current	$t_p \leq 10 \mu\text{s}$	I_{FSM}	3	A
Power dissipation	$T_{amb} \leq 25^\circ\text{C}$	P_V	100	mW
Junction temperature		T_j	100	$^\circ\text{C}$

Output (Detector)

Parameter	Test Conditions	Symbol	Value	Unit
Collector emitter voltage		V_{CEO}	32	V
Emitter collector voltage		V_{ECO}	5	V
Collector current		I_C	50	mA
Power dissipation	$T_{amb} \leq 25^\circ\text{C}$	P_V	100	mW
Junction temperature		T_j	100	$^\circ\text{C}$

Coupler

Parameter	Test Conditions	Symbol	Value	Unit
Total power dissipation	$T_{amb} \leq 25^\circ\text{C}$	P_{tot}	200	mW
Ambient temperature range		T_{amb}	-55 to +85	$^\circ\text{C}$
Storage temperature range		T_{stg}	-55 to +100	$^\circ\text{C}$
Soldering temperature	2 mm from case, $t \leq 5 \text{ s}$	T_{sd}	260	$^\circ\text{C}$



Electrical Characteristics ($T_{amb} = 25^{\circ}\text{C}$)

Input (Emitter)

Parameter	Test Conditions	Symbol	Min.	Typ.	Max.	Unit
Forward voltage	$I_F = 50 \text{ mA}$	V_F		1.25	1.6	V

Output (Detector)

Parameter	Test Conditions	Symbol	Min.	Typ.	Max.	Unit
Collector emitter voltage	$I_C = 1 \text{ mA}$	V_{CEO}	32			V
Emitter collector voltage	$I_E = 100 \mu\text{A}$	V_{ECO}	5			V
Collector dark current	$V_{CE} = 20 \text{ V}, I_F = 0, E = 0$	I_{CEO}			200	nA

Coupler

Parameter	Test Conditions	Symbol	Min.	Typ.	Max.	Unit
Collector current	$V_{CE} = 5 \text{ V}, I_F = 20 \text{ mA}, d = 1 \text{ mm}$ (figure 1)	$I_C^{1)}$	0.3	0.5		mA
Cross talk current	$V_{CE} = 5 \text{ V}, I_F = 20 \text{ mA}$ (figure 1)	$I_{CX}^{2)}$			1	μA
Collector emitter saturation voltage	$I_F = 20 \text{ mA}, I_C = 0.1 \text{ mA}, d = 1 \text{ mm}$ (figure 1)	$V_{CEsat}^{1)}$			0.3	V

¹⁾ Measured with the 'Kodak neutral test card', white side with 90% diffuse reflectance

²⁾ Measured without reflecting medium

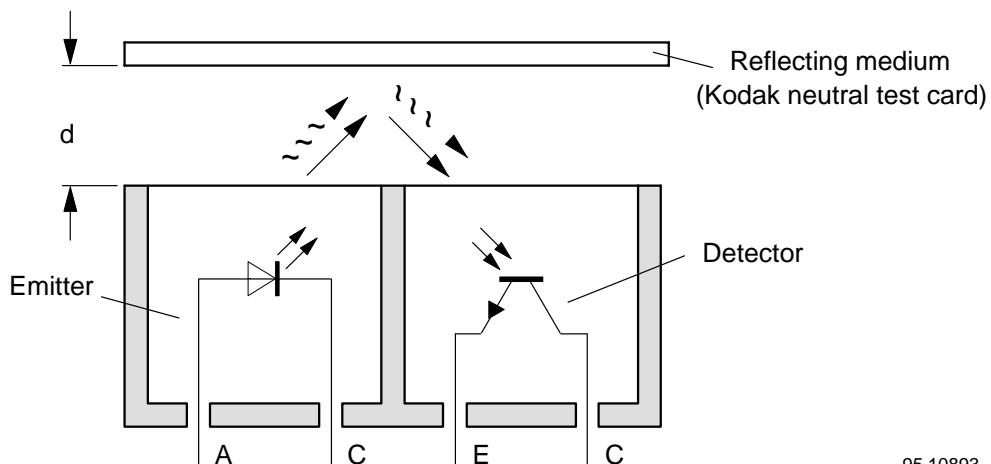

95 10893

Figure 1. Test circuit

TCRT1000/ TCRT1010

Vishay Telefunken



Typical Characteristics ($T_{amb} = 25^{\circ}\text{C}$, unless otherwise specified)

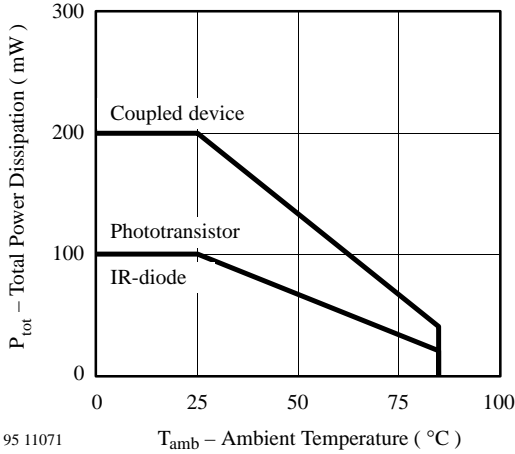

95 11071

Figure 2. Total Power Dissipation vs. Ambient Temperature

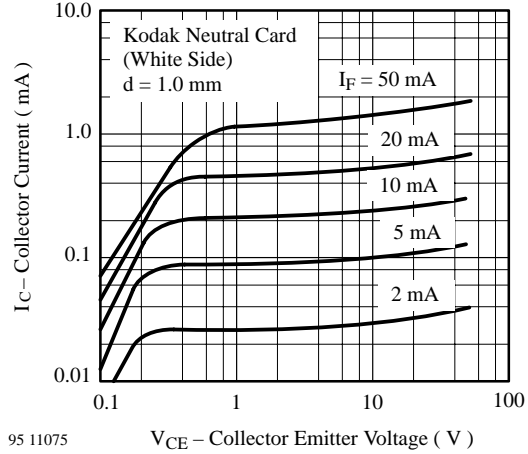

95 11075

Figure 5. Collector Current vs. Collector Emitter Voltage

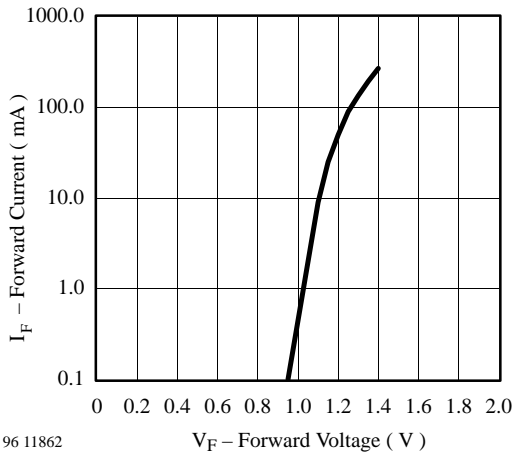

96 11862

Figure 3. Forward Current vs. Forward Voltage

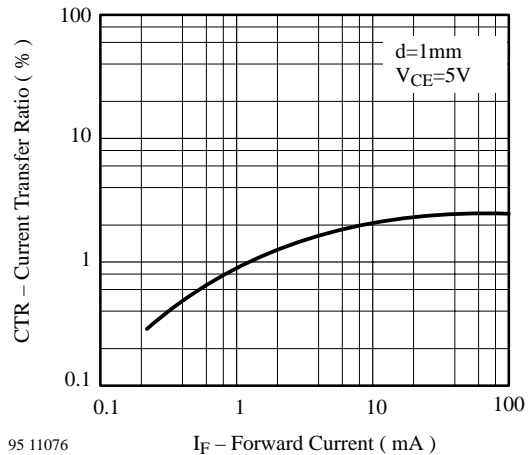

95 11076

Figure 6. Current Transfer Ratio vs. Forward Current

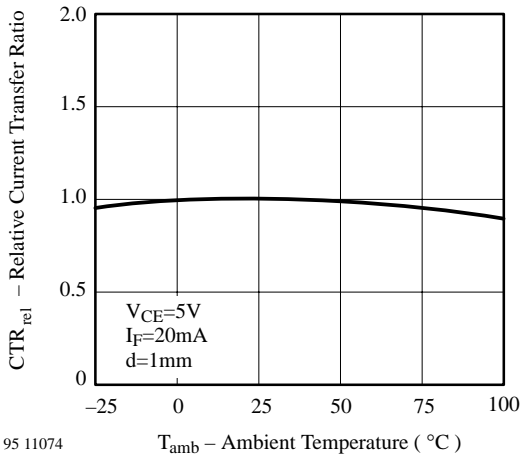

95 11074

Figure 4. Relative Current Transfer Ratio vs. Ambient Temperature

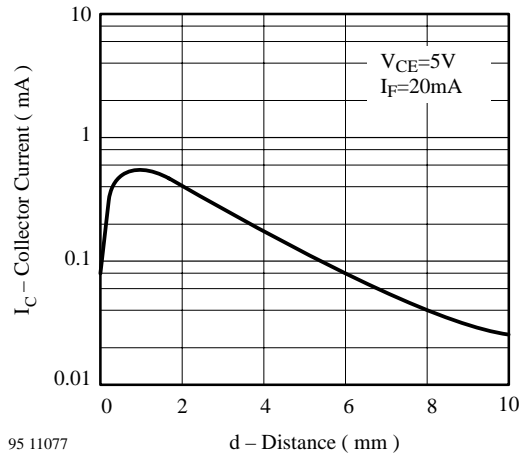

95 11077

Figure 7. Collector Current vs. Distance

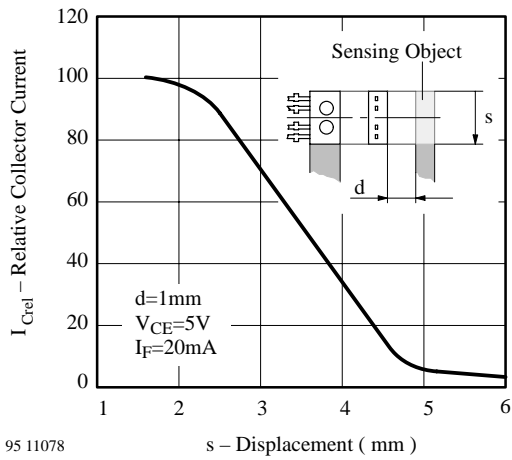
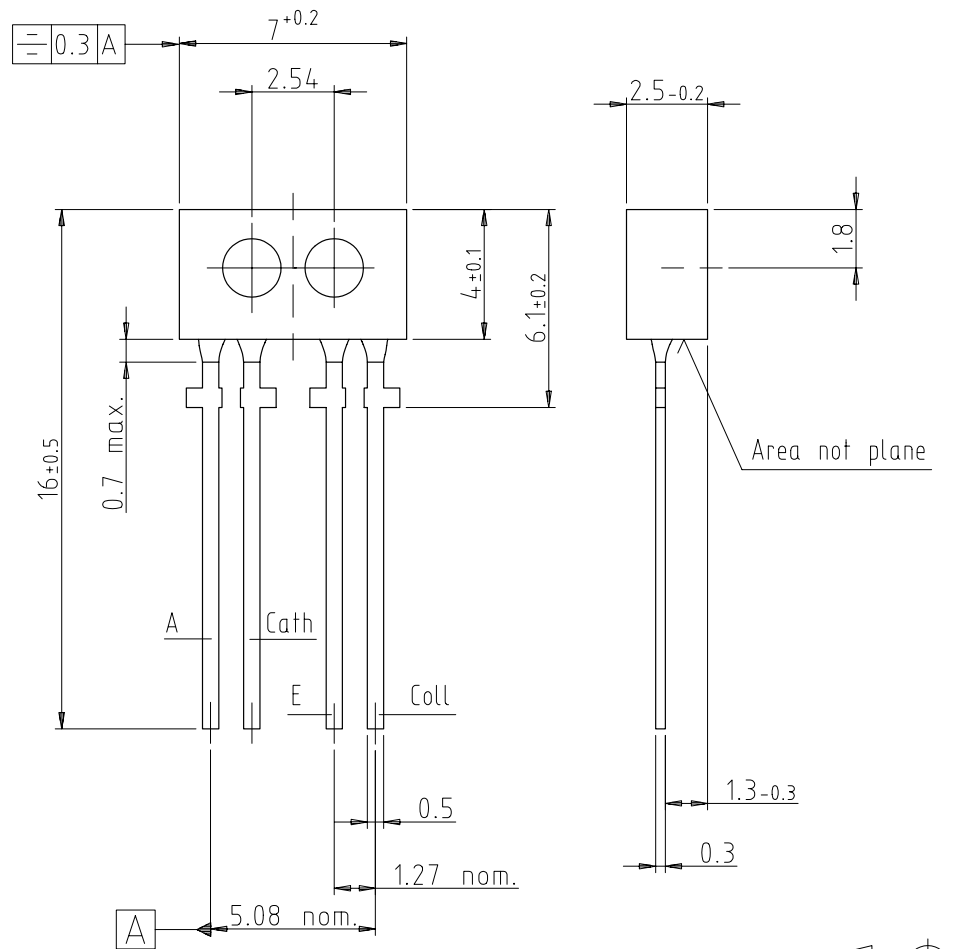

Figure 8. Relative Collector Current vs. Displacement

Dimensions of TCRT1000 in mm



Drawing-No.: 6.544-5162.01-4
 Issue: 2; 10.11.98

weight: ca. 0.15g

14768

technical drawings
 according to DIN
 specifications

TCRT1000/ TCRT1010

Vishay Telefunken



Dimensions of TCRT1010 in mm

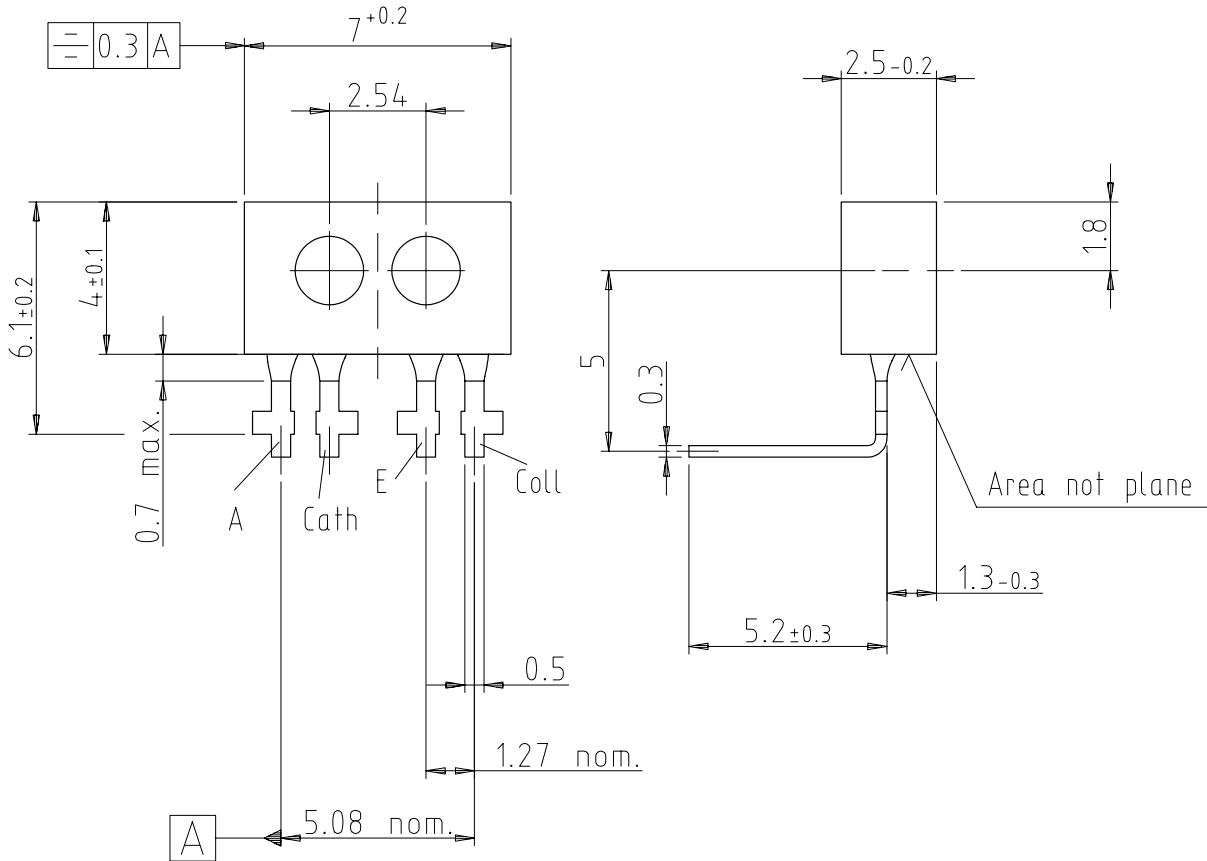

Drawing-No.: 6.544-5174.01-4
Issue: 2; 10.11.98

weight: ca. 0.15g

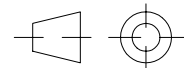

technical drawings
according to DIN
specifications

14769



Ozone Depleting Substances Policy Statement

It is the policy of **Vishay Semiconductor GmbH** to

1. Meet all present and future national and international statutory requirements.
2. Regularly and continuously improve the performance of our products, processes, distribution and operating systems with respect to their impact on the health and safety of our employees and the public, as well as their impact on the environment.

It is particular concern to control or eliminate releases of those substances into the atmosphere which are known as ozone depleting substances (ODSs).

The Montreal Protocol (1987) and its London Amendments (1990) intend to severely restrict the use of ODSs and forbid their use within the next ten years. Various national and international initiatives are pressing for an earlier ban on these substances.

Vishay Semiconductor GmbH has been able to use its policy of continuous improvements to eliminate the use of ODSs listed in the following documents.

1. Annex A, B and list of transitional substances of the Montreal Protocol and the London Amendments respectively
2. Class I and II ozone depleting substances in the Clean Air Act Amendments of 1990 by the Environmental Protection Agency (EPA) in the USA
3. Council Decision 88/540/EEC and 91/690/EEC Annex A, B and C (transitional substances) respectively.

Vishay Semiconductor GmbH can certify that our semiconductors are not manufactured with ozone depleting substances and do not contain such substances.

We reserve the right to make changes to improve technical design and may do so without further notice. Parameters can vary in different applications. All operating parameters must be validated for each customer application by the customer. Should the buyer use Vishay Telefunken products for any unintended or unauthorized application, the buyer shall indemnify Vishay Telefunken against all claims, costs, damages, and expenses, arising out of, directly or indirectly, any claim of personal damage, injury or death associated with such unintended or unauthorized use.

Vishay Semiconductor GmbH, P.O.B. 3535, D-74025 Heilbronn, Germany
Telephone: 49 (0) 7131 67 2831, Fax number: 49 (0) 7131 67 2423