



v01.1009



HMC874LC3C

20 Gbps CLOCKED COMPARATOR with RSPECL OUTPUT STAGE

Typical Applications

The HMC874LC3C is ideal for:

- ATE Applications
- High Speed Instrumentation
- Digital Receiver Systems
- Pulse Spectroscopy
- High Speed Trigger Circuits
- Clock & Data Restoration

Features

- Propagation Delay Clock to Output: 120 ps
- Overdrive & Slew Rate Dispersion: 10 ps
- Minimum Pulse Width: 60 ps
- Resistor Programmable Hysteresis
- Differential Clock Control
- Input Bandwidth: 10 GHz
- Power Dissipation: 150 mW
- RSCML and RSECL Versions Available
- 16 Lead 3x3mm SMT Package: 9mm²

Functional Diagram

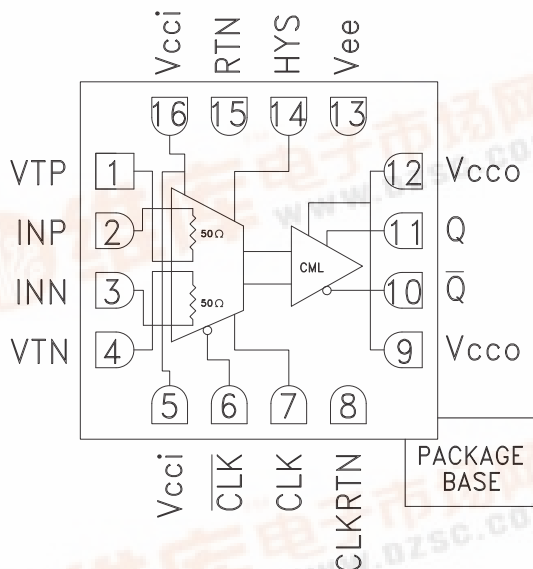

General Description

The HMC874LC3C is a SiGe monolithic, ultra fast comparator which features reduced swing PECL output drivers and clock inputs. The comparator supports 20 Gbps operation while providing 120 ps clock to data output delay and 60 ps minimum pulse width with 0.2 ps rms random jitter (RJ). 25 Gbps operation can be achieved with reduced output voltage swing. Overdrive and slew rate dispersion are typically 10 ps, making the device ideal for a wide range of applications from ATE to broadband communications. The reduced swing PECL output stages are designed to directly drive 400 mV into 50 Ohms terminated to +1.3V while maintaining compatibility with other PECL logic families. The HMC874LC3C features high speed latches with programmable hysteresis, and is configured to operate as a clocked comparator.

Electrical Specifications $T_A = +25C$,

$V_{cc} = +3.3V$, $V_{cc0} = +3.3V$, $CLK / \overline{CLK} = 1.6$ to $2.4V$, $V_{ee} = -3V$, $V_{TERM} = +1.3V$

| Parameter | Conditions | Min. | Typ. | Max. | Units |
|---|--------------------|-------|------|------|---------|
| Input Voltage Range | | -2 | | 2 | V |
| Input Differential Voltage | | -1.75 | | 1.75 | V |
| Input Offset Voltage | | | ±5 | | mV |
| Input Offset Voltage, Temperature Coefficient | | | 15 | | μV / °C |
| Input Bias Current | | | 15 | | μA |
| Input Bias Current Temperature Coefficient | | | 50 | | nA / °C |
| Input Offset Current | | | 4 | | μA |
| Input Impedance | | | 50 | | Ω |
| Common Mode Input Impedance | | | 350 | | KΩ |
| Differential Input Impedance | | | 15 | | KΩ |
| Hysteresis | $R_{hys} = \infty$ | | ±1 | | mV |

For price, delivery, and to place orders, please contact Hittite Microwave Corporation:
 20 Alpha Road, Chelmsford, MA 01824 Phone: 978-250-3343 Fax: 978-250-3373
 Order On-line at www.hittite.com





v01.1009

HMC874LC3C

20 Gbps CLOCKED COMPARATOR with RSPECL OUTPUT STAGE

Latch Enable Characteristics

| Parameter | Conditions | Min. | Typ. | Max | Units |
|---------------------------------|------------|------|------|-----|----------|
| Clock Enable Input Impedance | Each Pin | | 50 | | Ω |
| Clock to Data Output Delay, tdp | | | 120 | | ps |
| Clock Enable Input Range | | 1.6 | | 2.4 | V |
| Clock Max Frequency, fmax | | | 25 | | GHz |

DC Output Characteristics, $V_{CCO} = +3.3V$, $V_{TERM} = +1.3V$

| Parameter | Conditions | Min. | Typ. | Max | Units |
|-----------------------------------|------------|------|------|------|-------|
| Output Voltage High Level, Voh | | 2.30 | | 2.42 | V |
| Output Voltage Low Level, Vol | | 1.94 | | 2.10 | V |
| Output Voltage Differential Swing | | 320 | | 420 | mV |

AC Performance

| Parameter | Conditions | Min. | Typ. | Max | Units |
|--|--|------|------|------|--------|
| VOD Dispersion | 50mV < VOD < 1V | | 10 | | ps |
| Tpd vs. Common Mode Dispersion, -1.75V < Vcm < 1.75V | VOD = 50 mV | | 8 | | ps |
| Equivalent Input Bandwidth [1] | | 13.5 | | 16.2 | GHz |
| Deterministic Jitter (pp) | Deterministic Jitter at 10 Gbps with $\pm 100mV$ Overdrive | | < 3 | | ps |
| Random Jitter (rms) | Random Jitter at 10 Gbps with $\pm 100mV$ Overdrive | | 0.2 | | ps rms |
| Minimum Pulse Width | $V_{CM} = 0$; $\pm 100mV$ Overdrive | | 60 | | ps |
| Q / \bar{Q} Rise Time | From 20% to 80% | | 26 | | ps |
| Q / \bar{Q} Fall Time | From 20% to 80% | | 21 | | ps |

Power Supply Requirements

| Parameter | Conditions | Min. | Typ. | Max | Units |
|-----------------------------|------------|------|------|-----|-------|
| Input Supply Current, Icci | | | 11 | | mA |
| Output Supply Current, Icco | | | 40 | | mA |
| Vee Current, Iee | | | 21 | | mA |
| Power Dissipation, Pd | | | 150 | | mW |
| PSRR, Vcci | | | 38 | | dB |
| PSRR, Vee | | | 38 | | dB |

Note 1: Equivalent Input Bandwidth is calculated with the following formula: $B_{weq} = 0.22 / J$ (TRCOMP2-TRIN2) where TRIN is the 20%/80% transition time of a quasi-Gaussian signal applied to the comparator input, and TRCOMP is the effective transition time digitized by the comparator.



v01.1009



HMC874LC3C

20 Gbps CLOCKED COMPARATOR with RSPECL OUTPUT STAGE

6

COMPARATORS - SMT

Dispersion vs. Overdrive Voltage

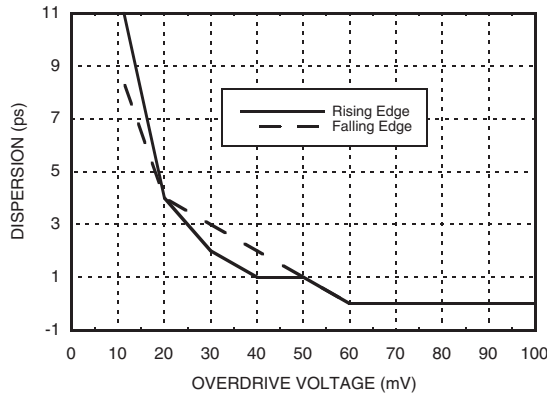

Propagation Delay vs. Input Common Mode Voltage^[1]

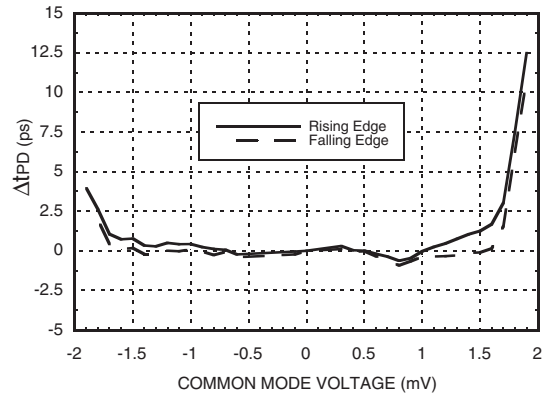

Output Voltage vs. Temperature

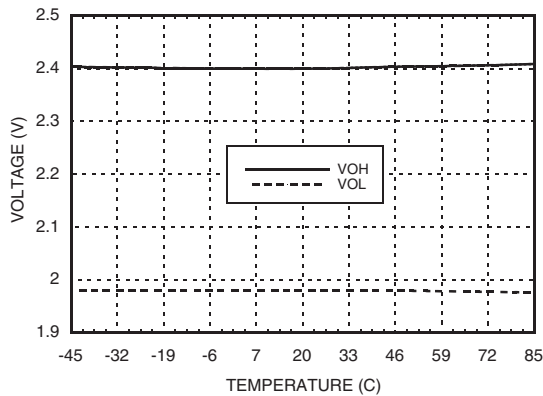

Voltage Swing vs. Temperature

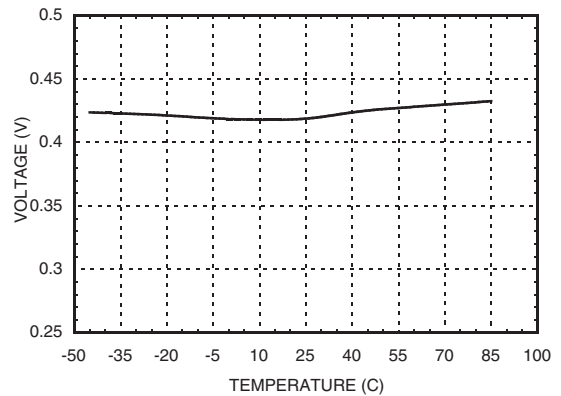

Delay vs. Temperature

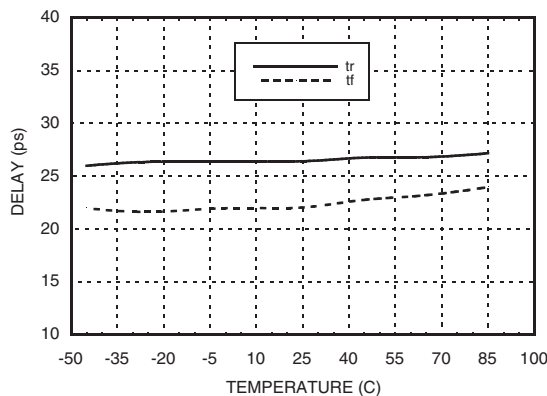

Power Dissipation vs. Temperature

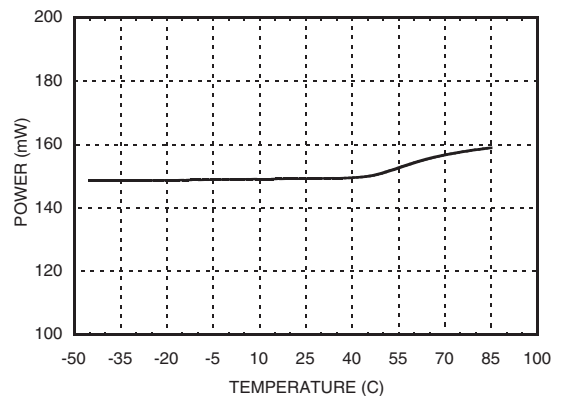

[1] V_{cci} = +3.3V, V_{cco} = +3.3V, V_{ee} = -3V, V_{TERM} = +1.3V



v01.1009



HMC874LC3C

20 Gbps CLOCKED COMPARATOR with RSPECL OUTPUT STAGE

Comparator Hysteresis vs. Rhys Control Resistor

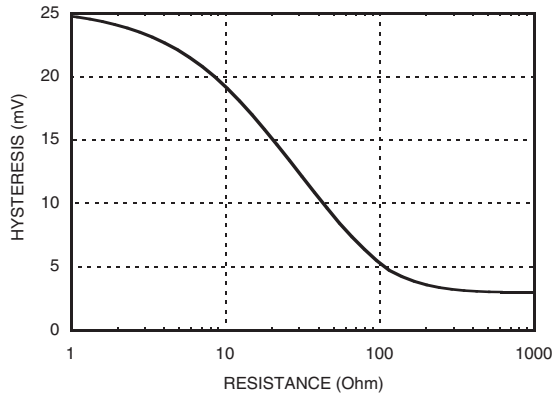

Comparator Hysteresis vs. Clock Frequency (Rhys = ∞)

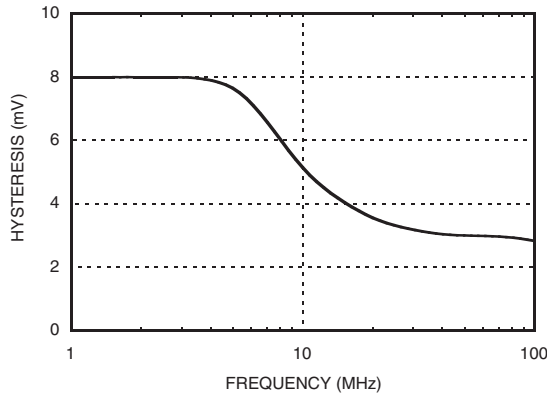

Currents vs. Temperature

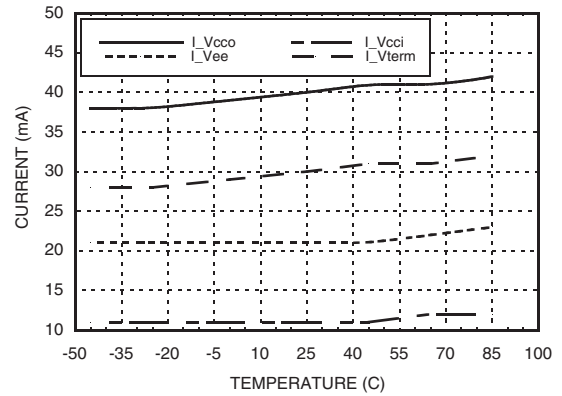

Eye Diagram

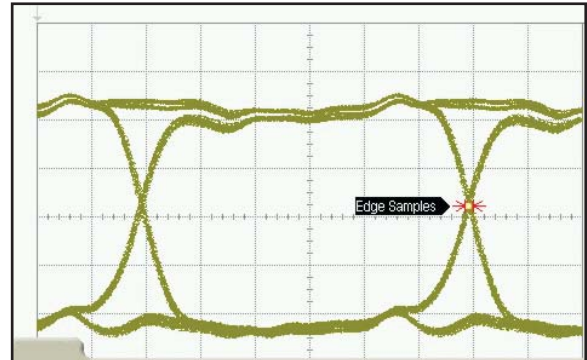

| | | | | | |
|------------|---------|-----------|---------|------------|---------|
| TJ(1E-12): | 6.71 ps | DJ(δ-δ): | 3.08 ps | RJ(rms): | 265 fs |
| RJ(δ-δ): | 310 fs | DDJ(p-p): | 3.24 ps | DCD: | ----- |
| PJ(rms) | 0.0 s | | | ISI J(p-p) | 3.24 ps |

Absolute Maximum Ratings

| | |
|---|---------------------|
| Input Supply Voltage (Vcci to GND) | -0.5V to +4V |
| Output Supply Voltage (Vcco to GND) | -0.5V to +4V |
| Positive Supply Differential (Vcci - Vcco) | -0.5V to +3.5V |
| Input Voltage | -2V to +2V |
| Differential Input Voltage | -2V to +2V |
| Input Voltage, Latch Enable | -0.5V to Vcci +0.5V |
| Applied Voltage (HYS) | Vee to GND |
| Maximum Input Current | ±1 mA |
| Output Current | 40 mA |
| Junction Temperature | 125°C |
| Continuous Pdiss (T = 85°C) (Derate 20.4 mW/°C above 85°C) | 0.816 W |
| Thermal Resistance (Rth) (Junction to Lead) | 49 °C/W |
| Storage Temperature | -65°C to +150°C |
| Operating Temperature | -40°C to +85°C |

| | |
|------------|--------------|
| Bit Rate | 5.00000 Gb/s |
| Pat Length | 127 Bits |
| Div. Ratio | 1:8 |



ELECTROSTATIC SENSITIVE DEVICE
OBSERVE HANDLING PRECAUTIONS



v01.1009



HMC874LC3C

20 Gbps Clocked Comparator with RSPECL OUTPUT STAGE

Timing Diagram

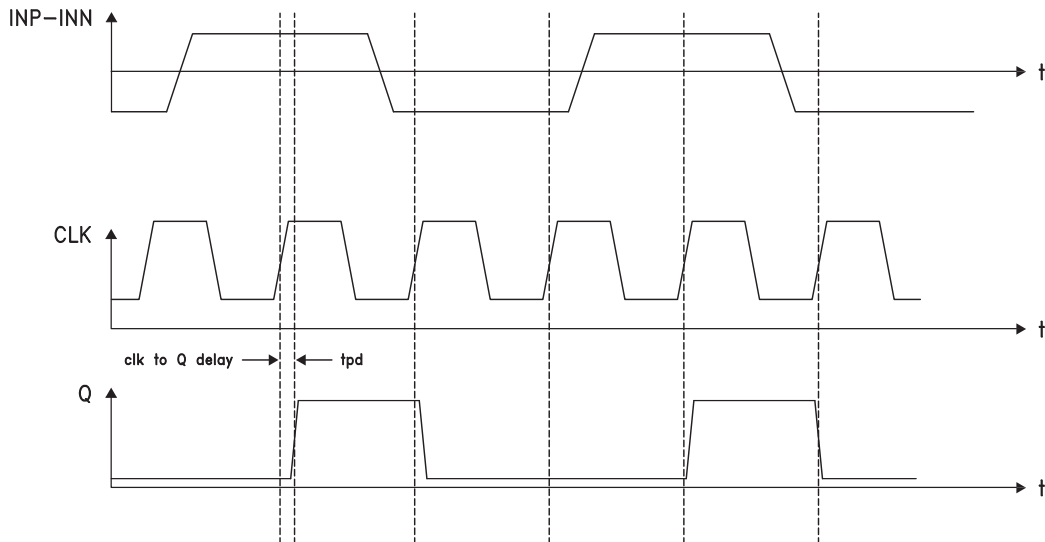

Outline Drawing

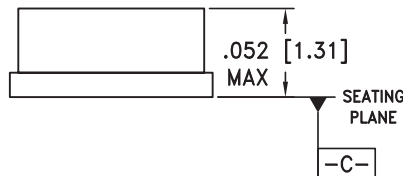
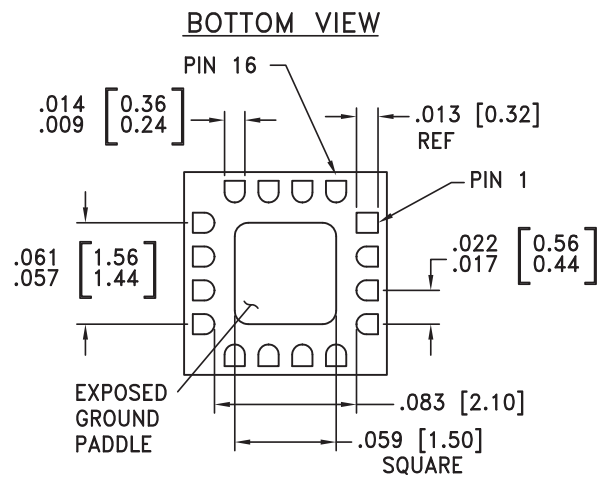
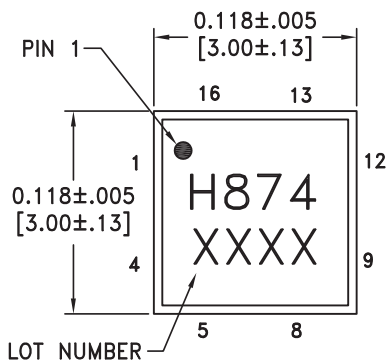

NOTES:

1. PACKAGE BODY MATERIAL: ALUMINA
2. LEAD AND GROUND PADDLE PLATING:
30-80 MICROINCHES GOLD OVER 50 MICROINCHES MINIMUM NICKEL.
3. DIMENSIONS ARE IN INCHES [MILLIMETERS].
4. LEAD SPACING TOLERANCE IS NON-CUMULATIVE.
5. PACKAGE WARP SHALL NOT EXCEED 0.05mm DATUM -C-
6. ALL GROUND LEADS MUST BE SOLDERED TO PCB RF GROUND.
7. PADDLE MUST NOT BE DC GND. THERMAL DISSIPATION PATH ONLY.

For price, delivery, and to place orders, please contact Hittite Microwave Corporation:
20 Alpha Road, Chelmsford, MA 01824 Phone: 978-250-3343 Fax: 978-250-3373
Order On-line at www.hittite.com



v01.1009



HMC874LC3C

20 Gbps CLOCKED COMPARATOR with RSPECL OUTPUT STAGE

Pin Descriptions

| Pin Number | Function | Description | Interface Schematic |
|------------|-------------------------|--|---------------------|
| 1 | VTP | Termination resistor return pin for INP Input. | |
| 2 | INP | Non-Inverting analog input | |
| 3 | INN | Inverting analog input | |
| 4 | VTN | Termination resistor return pin for INN input | |
| 5, 16 | Vcci | Positive supply voltage input stage. | |
| 6 | $\overline{\text{CLK}}$ | Clock input pin, inverting side. | |
| 7 | CLK | Clock input pin, non-inverting side. | |
| 8 | CLKRTN | Clock RTN pin, connect to GND. | |
| 9, 12 | Vcco | Positive supply voltage for the output stage. | |
| 10 | $\overline{\text{Q}}$ | Inverting output. Q bar is at logic low if the analog voltage at the non-inverting input, INP, is greater than the analog voltage at the inverting input, INN, after a positive transition on CLK and negative transition on $\overline{\text{CLK}}$. | |
| 11 | Q | Non-inverting output. Q is at logic high if the analog voltage at the non-inverting input, INP, is greater than the analog voltage at the inverting input, INN, after a positive transition on CLK and negative transition on CLK. | |
| 14 | HYS | Hysteresis Control pin. This pin should be left disconnected to minimize hysteresis. Connect to Vee with a resistor to add the desired amount of hysteresis. | |
| 13 | Vee | Negative power supply, -3V. | |
| 15 | RTN | Return for ESD protection, connect to GND. | |
| | Package Base | Do not DC GND. Thermal dissipation path only. | |

查询"HMC874LC3C_1"供应商



v01.1009



HMC874LC3C

20 Gbps CLOCKED COMPARATOR with RSPECL OUTPUT STAGE

Evaluation PCB

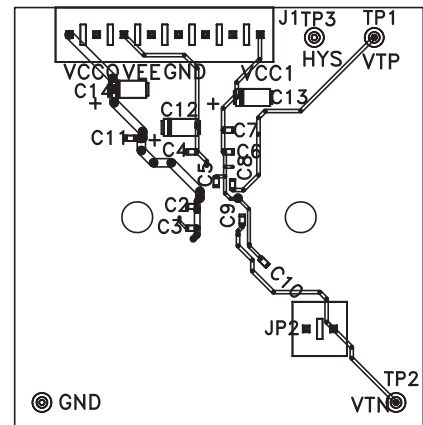
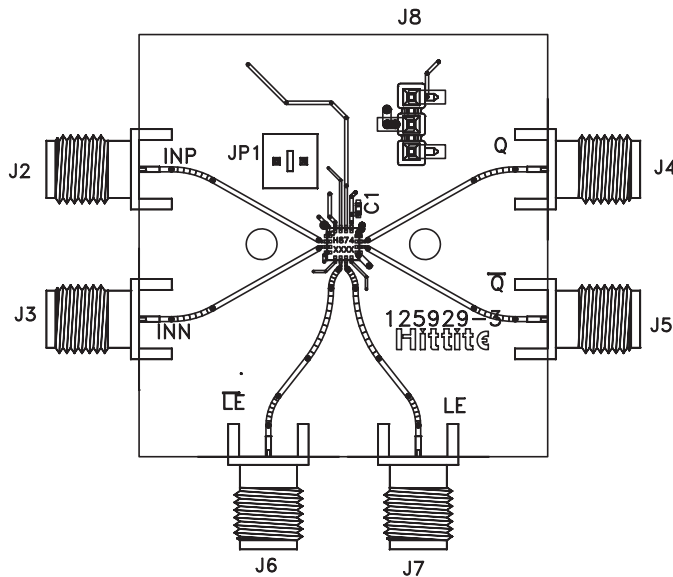

List of Materials for Evaluation PCB 125932 [1]

| Item | Description |
|---------------------------|--------------------------------------|
| J1 | 8 Pos. Vertical TIN |
| J2 - J7 | 2.92 mm 40 GHz Jack |
| J8 | Terminal Strip, Single Row 3 Pin SMT |
| JP1, JP2 | 2 Pos. Vertical TIN |
| C1 - C3, C5, C6, C8 - C10 | 100 pF Capacitor, 0402 Pkg. |
| C4, C7, C11 | 330 pF Capacitor, 0402 Pkg. |
| C11 - C13 | 4.7 uF Tantalum |
| TP1 - TP4 | DC Pin, Swage Mount |
| U1 | HMC874LC3C Comparator |
| PCB | 125929 Evaluation PCB |

[1] Reference this number when ordering complete evaluation PCB

[2] Circuit Board Material: Rogers 4350 or Arlon 25FR

The circuit board used in the final application should use RF circuit design techniques. Signal lines should have 50 ohm impedance while the package ground leads should be connected directly to the ground plane similar to that shown. The exposed paddle should not be electronically connected to DC GND, thermal dissipation path only. A sufficient number of via holes should be used to connect the top and bottom ground planes in order to provide good RF grounding to 25 GHz. The evaluation circuit board shown is available from Hittite upon request.



v01.1009



HMC874LC3C

20 Gbps CLOCKED COMPARATOR with RSPECL OUTPUT STAGE

Application Circuit

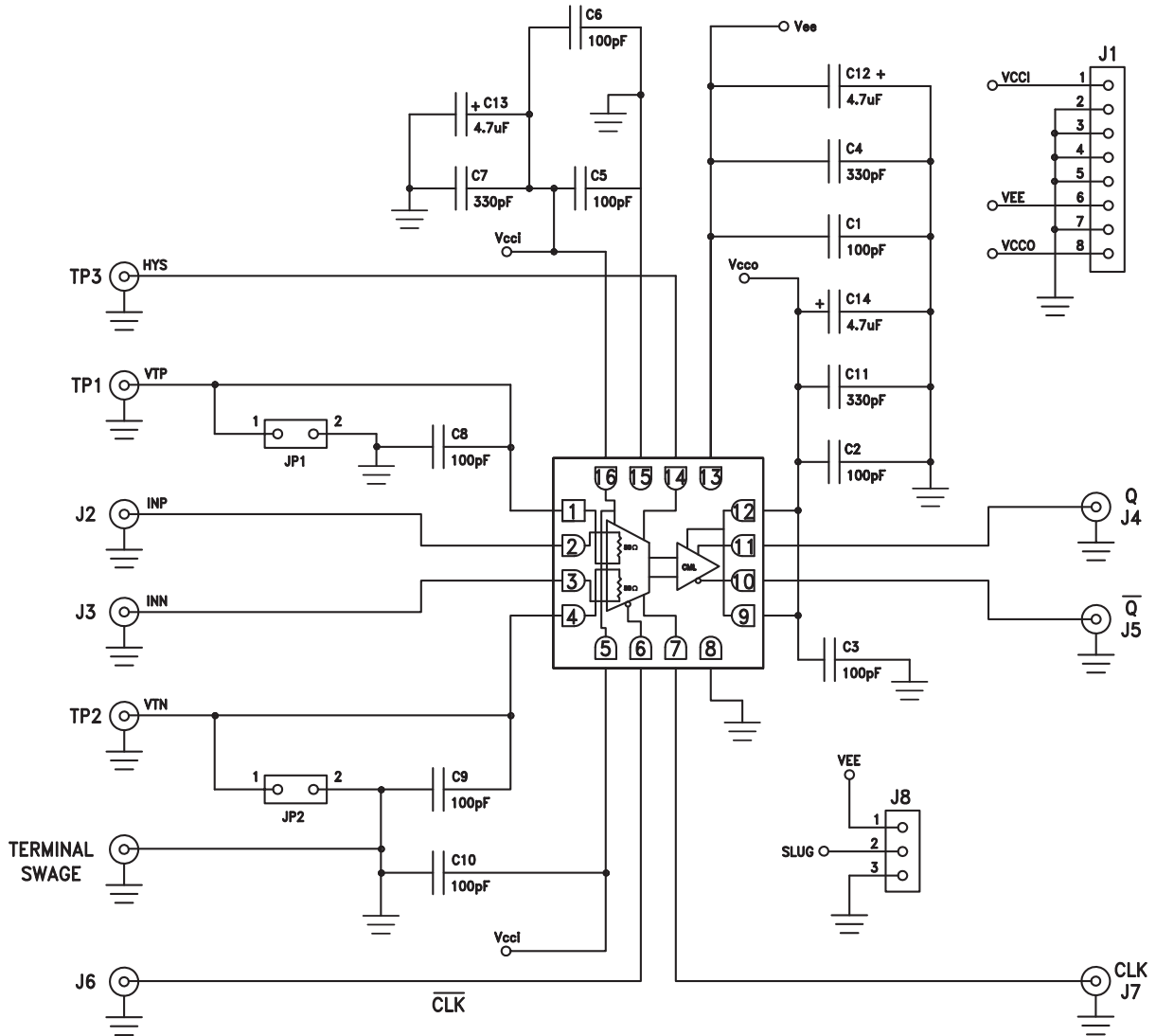

This datasheet has been downloaded from:

www.EEworld.com.cn

Free Download

Daily Updated Database

100% Free Datasheet Search Site

100% Free IC Replacement Search Site

Convenient Electronic Dictionary

Fast Search System

www.EEworld.com.cn