

General Description

The MIC2238 is dual output, High-efficiency synchronous step-down DC/DC converter. The MIC2238 is ideally suited for portable systems which demand high power conversion efficiencies while offered in a very small package. The MIC2238 offers an ultra-low quiescent current in light load mode assuring minimum current draw from battery powered applications in standby modes. The MIC2238 was designed for use of miniature 2.2 μ H inductors and 2.2 μ F ceramic capacitors.

The MIC2238 features a selectable mode that allows the user to trade-off lowest noise performance for low power efficiency. Trickle mode operation provides ultra-high efficiency at light loads, while PWM operation provides very low ripple noise performance. To maximize battery life in low-dropout conditions, MIC2238 can operate with a maximum duty cycle of 100%.

The MIC2238 is available in a space-saving 3mm x 3mm MLF[®]-12L package with a junction temperature range from -40°C to +125°C.

Data sheets and support documentation can be found on Micrel's web site at www.micrel.com.

Features

- High Efficiency: Up to 95%
- Ultra-low quiescent current: Only 28 μ A
- Ultra-low shutdown current less than 1 μ A
- 2.5MHz PWM operation
- High output current capability per channel: 800mA
- No Schottky Diodes Required
- Stable with 2.2 μ H inductor, 2.2 μ F ceramic capacitor
- Adjustable output voltage down to 0.8V
- Built-in soft-start circuitry
- Current limit protection
- Automatic switching into light load mode operation
- /FPWM pin allows low noise all-PWM mode operation
- Power good output with internal 5 μ A current source allows sequencing with programmable delay time
- Small Thermally Enhanced 3mm x 3mm MLF[®] package

Applications

- Cellular phones
- PDAs
- Digital Cameras
- MP3 Players
- PC Cards
- Wireless and DSL Modems

Typical Application

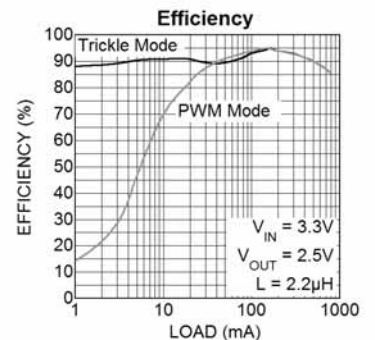
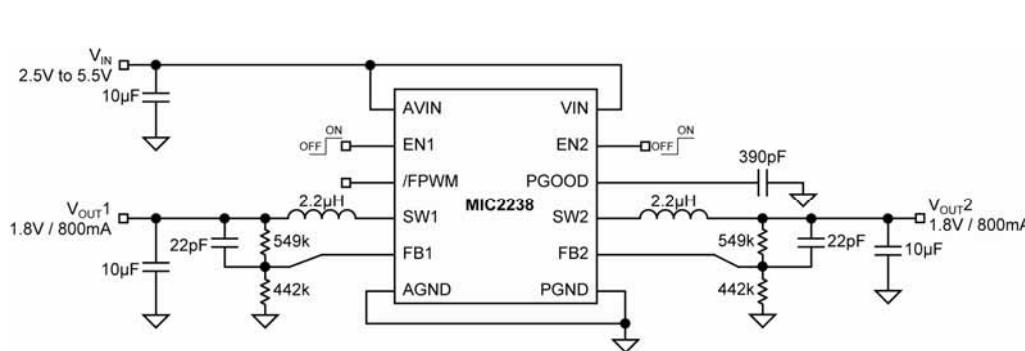

[查询"MIC2238"供应商](#)

Ordering Information

| Part Number | V _{OUT1} | V _{OUT2} | Lead Finish | Junction Temperature Range | Package |
|---------------|-------------------|-------------------|-------------|----------------------------|---------------|
| MIC2238-AAYML | Adjustable | Adjustable | Pb-Free | -40°C to +125°C | 3 × 3 MLF-12L |

Fixed output options available. Contact Micrel Marketing for further details.

Pin Configuration

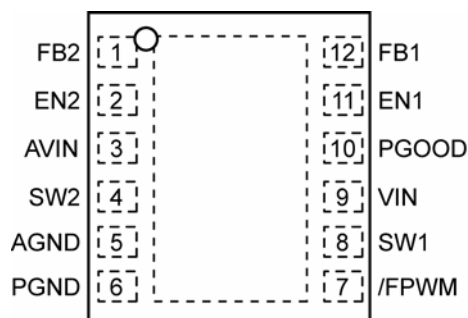

MIC2238-xxYML
12-Lead MLF[®] (ML)
(Top View)

Pin Description

| Pin Number Adjustable | Pin Number Fixed | Pin Name | Pin Name |
|-----------------------|------------------|----------|---|
| 1 | - | FB2 | Feedback 2: For adjustable voltage options connect the external resistor divider network to FB2 to set the output voltage of regulator 2. Nominal value is 0.8V. |
| 2 | 2 | EN2 | Enable 2 input. Logic low powers down regulator 2. Logic high powers up regulator 2. MIC2238 features built-in soft-start circuitry that reduces in-rush current and prevents the output voltage from overshooting at start up. |
| 3 | 3 | AVIN | Analog Supply Voltage: Supply voltage for the analog control circuitry. Requires bypass capacitor to GND. |
| 4 | 4 | SW2 | Switch node for regulator 2, connected to external inductor. |
| 5 | 5 | AGND | Analog (signal) ground. |
| 6 | 6 | PGND | Power ground. |
| 7 | 7 | /FPWM | Forced PWM Mode Bar. Grounding this pin forces the device to stay in constant frequency PWM mode only. Pulling this pin high enables automatic Trickle mode operation. |
| 8 | 8 | SW1 | Switch node for regulator 1, connected to external inductor. |
| 9 | 9 | VIN | Supply Voltage: Supply voltage for the internal switches and drivers. |
| 10 | 10 | PGOOD | Power Good Output. This output is pulled down unless the regulator 1 output voltage is within +6.25% and -8.5% of regulation. After the output voltage is in regulation, the output starts to go high with an internal 5µA current source. A delay time could be programmed by tying a capacitor to this pin. |

[查询"MIC2238"供应商](#)
Pin Out (cont.)

| Pin Number Adjustable | Pin Number Fixed | Pin Name | Pin Name |
|-----------------------|------------------|----------|---|
| 11 | 11 | EN1 | Enable 1 input. Logic low powers down regulator 1. Logic high powers up regulator 1. MIC2238 features built-in soft-start circuitry that reduces in-rush current and prevents the output voltage from overshooting at start up. |
| 12 | - | FB1 | Feedback 1: For adjustable voltage options connect to the external resistor divider network to FB1 to set the output voltage of regulator 1. Nominal value is 0.8V. |
| - | 1 | OUT2 | Output Voltage 2. For fixed output voltage options connect OUT2 to the output voltage of regulator 2. |
| - | 12 | OUT1 | Output Voltage 1. For fixed output voltage options connect OUT1 to the output voltage of regulator 1. |
| EP | EP | EP | Back-side pad. |

[查询"MIC2238"供应商](#)

Absolute Maximum Ratings⁽¹⁾

| | |
|---|-----------------|
| Supply Voltage (V_{IN}) | +6V |
| Enable 1 Voltage | +6V |
| Enable 2 Voltage | +6V |
| Logic Input Voltage (V_{EN} , V_{FPWM}) | V_{IN} to 0V |
| Storage Temperature (T_S) | -65°C to +150°C |
| ESD | 2KV |

Operating Ratings⁽²⁾

| | |
|--|-----------------|
| Supply Voltage (V_{IN}) | 2.5V to 5.5V |
| Junction Temperature (T_J) | -40°C to +125°C |
| Package Thermal Resistance (θ_{JA}) | 60°C/W |

Electrical Characteristics⁽⁴⁾

$T_A = 25^\circ\text{C}$ with $V_{IN} = V_{EN1} = V_{EN2} = 3.6\text{V}$, V_{OUT1} , V_{OUT2} , $L = 2.2\mu\text{H}$, $C = 2.2\mu\text{F}$, unless otherwise specified. **Bold** values indicate $-40^\circ\text{C} \leq T_J \leq +125^\circ\text{C}$.

| Parameter | Condition | Min | Typ | Max | Units |
|-----------------------------------|--|---------------------------------------|------|---------------------------------------|---------------|
| Supply Voltage and Current | | | | | |
| Supply Voltage Range | | 2.5 | | 5.5 | V |
| UVLO (rising) | | 2.3 | 2.4 | 2.5 | V |
| UVLO Hysteresis | | | 100 | | mV |
| PWM Mode Supply Current | /FPWM = Low, $I_{OUT} = 200\text{mA}$ | | 560 | 950 | μA |
| Trickle Mode Supply Current | /FPWM = High, $I_{OUT} = 100\mu\text{A}$ | | 28 | 50 | μA |
| Shutdown Quiescent Current | $V_{EN} = 0\text{V}$ | | 0.1 | 1 | μA |
| Output Voltage Accuracy | | | | | |
| Feedback voltage, V_{FB} | Adjustable | 0.780 | 0.8 | 0.820 | V |
| Output voltage, V_{OUT} | Fixed Output Options | -2.5 | | +2.5 | % |
| Feedback bias current | | | 10 | | nA |
| Output Voltage Line Regulation | $2.5\text{V} \leq V_{IN} \leq 5.5\text{V}$ | | 0.1 | 0.5 | % |
| Output Voltage Load Regulation | $V_{IN} = 5\text{V}$, $I_{OUT} = 10\text{mA}$ to 800mA , /FPWM = 0V $V_{IN} = 3\text{V}$; $I_{OUT} = 10\text{mA}$ to 800mA , /FPWM = 0V | | 0.5 | | % |
| Ripple in Trickle Mode | $V_{IN} = 3.6\text{V}$; $I_{OUT} = 1\text{mA}$; $C_{OUT} = 2.2\mu\text{F}$, $L = 2.2\mu\text{H}$. | | 40 | | mV |
| Logic Inputs | | | | | |
| EN Input Threshold | On | | 0.8 | 1.2 | V |
| | Off | 0.3 | 0.7 | | V |
| EN Input Current | | | 0.01 | 1 | μA |
| /FPWM Input Threshold | On | | | $0.6 \times V_{IN}$ | V |
| | Off | $0.3 \times V_{IN}$ | | | V |
| /FPWM Input Current | | | 0.01 | 1 | μA |

[查询"MIC2238"供应商](#)

Electrical Characteristics (cont.)⁽⁴⁾

| Parameter | Condition | Min | Typ | Max | Units |
|--------------------------------------|--|--------------|--------------|--------------|------------|
| Protection | | | | | |
| Current Limit | Peak Switch Current, $V_{OUT} = 0V$ | 0.9 | 1.2 | 1.8 | A |
| Over Temperature Shutdown Hysteresis | | | 20 | | °C |
| Control | | | | | |
| Maximum Duty Cycle | $V_{FB} = 0.7V$ | 100 | | | % |
| Oscillator | | | | | |
| PWM Mode Frequency | | 2.125 | 2.5 | 2.875 | MHz |
| Power Good | | | | | |
| Power Good Reset Threshold | Upper Threshold Lower Threshold | -14 | 6.25 -8.5 | 12 | % |
| PGOOD Series Resistance | | | 1 | 1.4 | k Ω |
| PGOOD Pull-Up Current | Output within 8.5% of regulation | | 5 | | μA |
| Power Switch | | | | | |
| Switch On-Resistance | $I_{SW} = 150mA$ (PFET) $I_{SW} = 150mA$ (NFET) | | 0.4 0.35 | | Ω |

Notes:

1. Exceeding the absolute maximum rating may damage the device.
2. The device is not guaranteed to function outside its operating rating.
3. Devices are ESD sensitive. Handling precautions recommended. Human body model, 1.5k Ω in series with 100pF.
4. Specification for packaged product only.

查询“MIC2238”供应商
Typical Characteristics

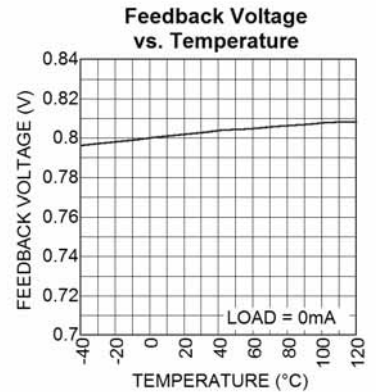
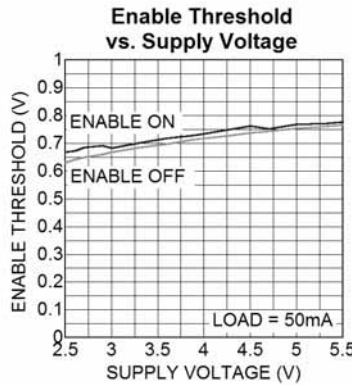
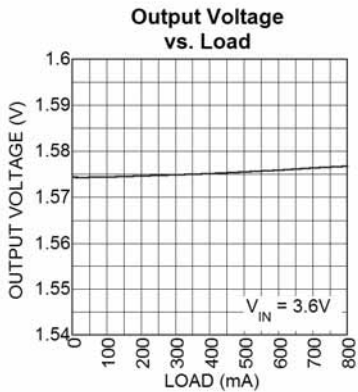
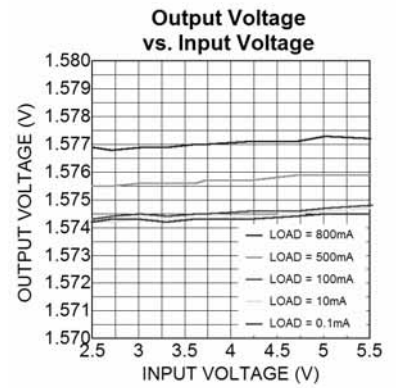
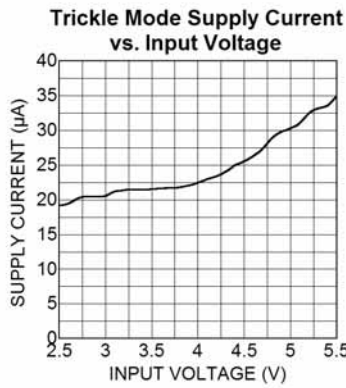
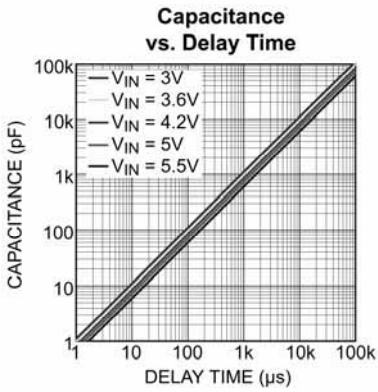
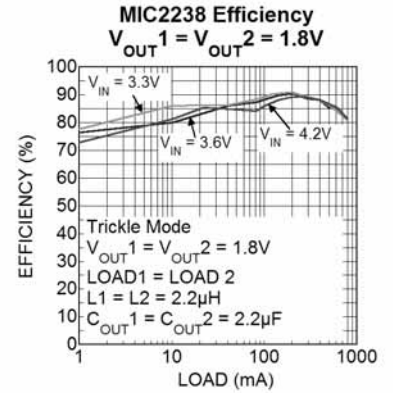
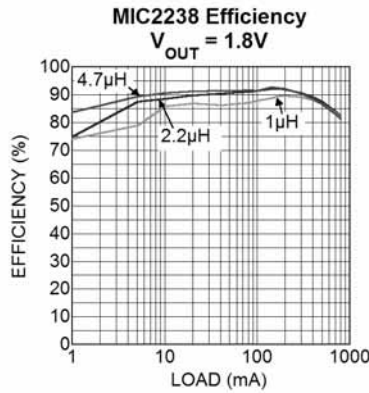
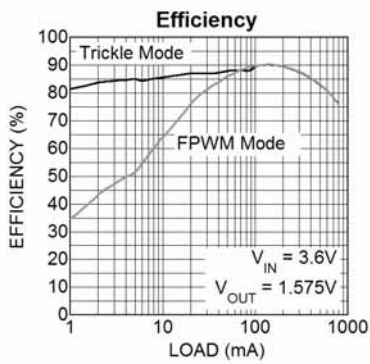
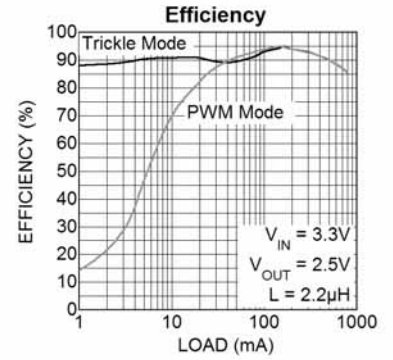
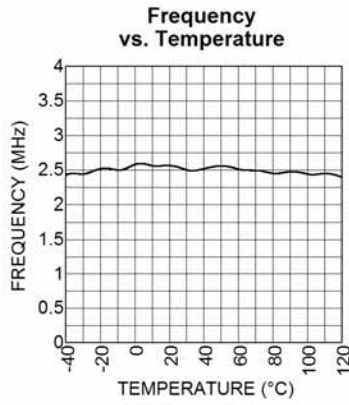
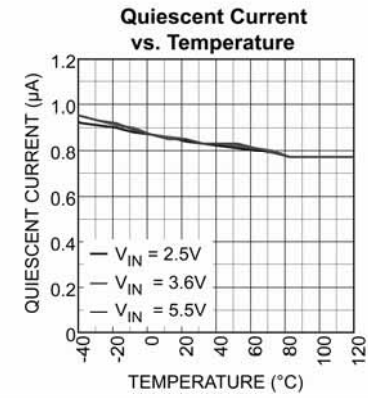

[查询"MIC2238"供应商](#)

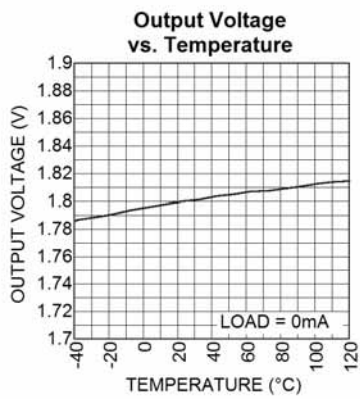

查询"MIC2238"供应商

Functional Characteristics

VIN = 3.6V, VOUT = 1.8V, L = 2.2μH, /FPWM = 0

Transient Response FPWM Mode

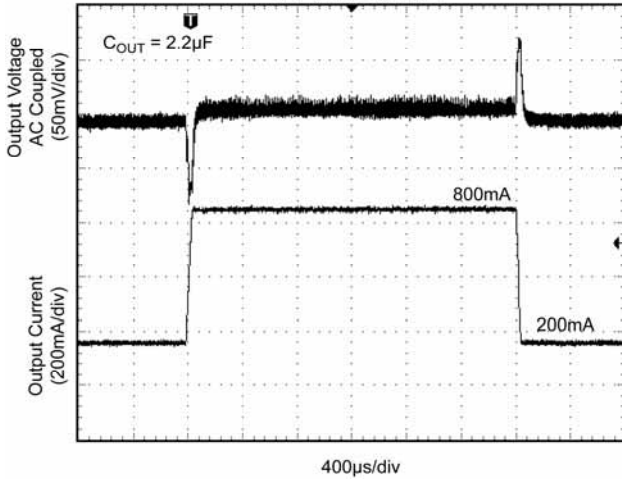

VIN = 3.6V, VOUT = 1.8V, L = 2.2μH, /FPWM = 3.6V

Transient Response Trickle Mode

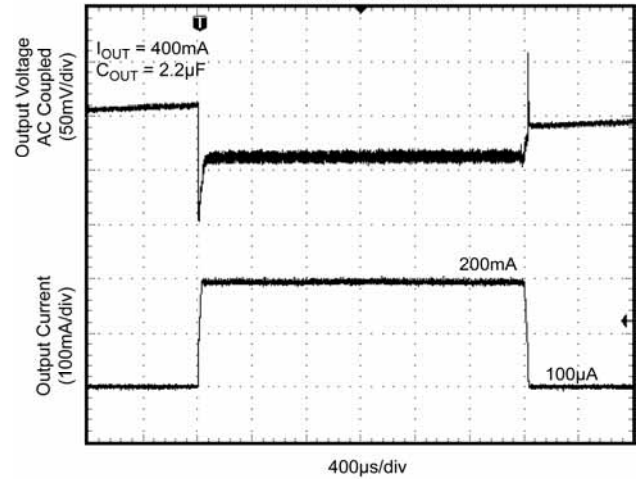

Switching Waveform FPWM Mode

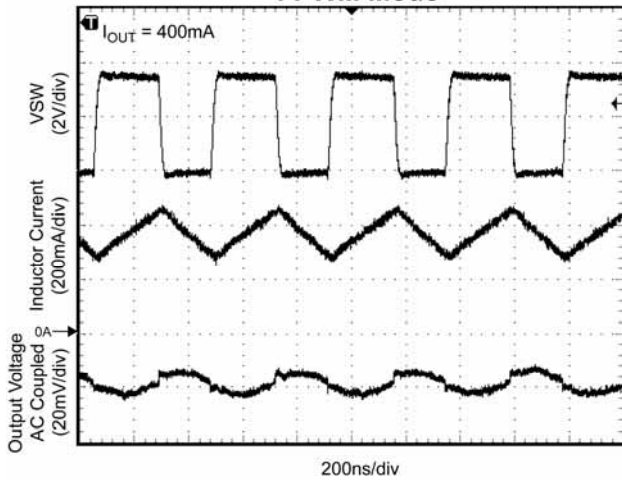

Switching Waveform Trickle Mode

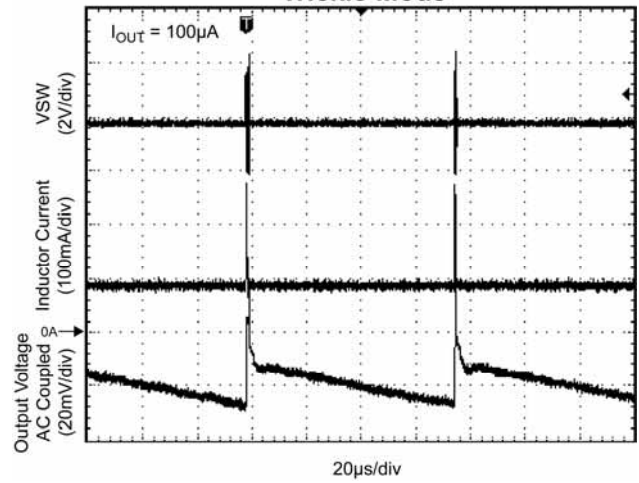

Enable Response

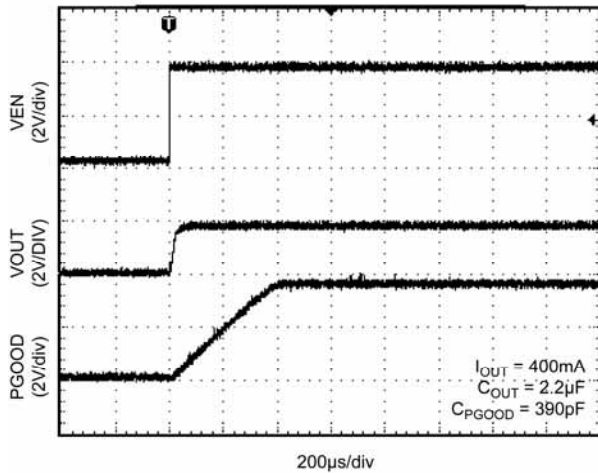

查询"MIC2238"供应商
Functional Characteristics

Transient Response

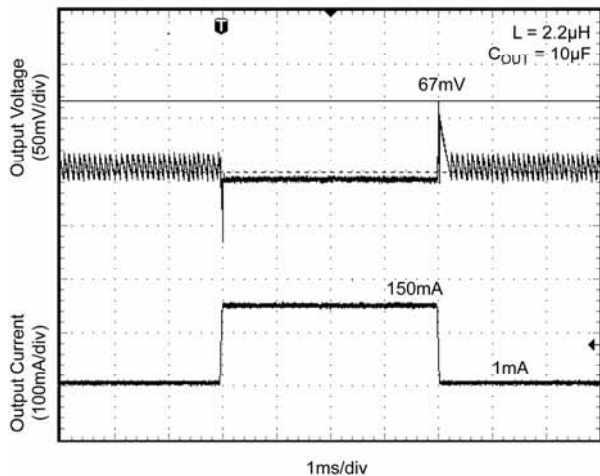

Transient Response

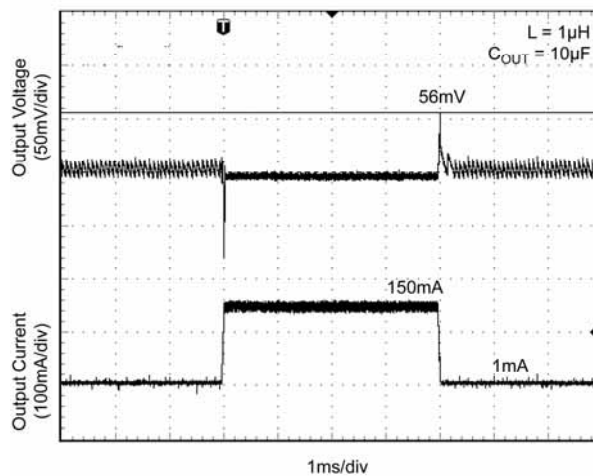

Transient Response

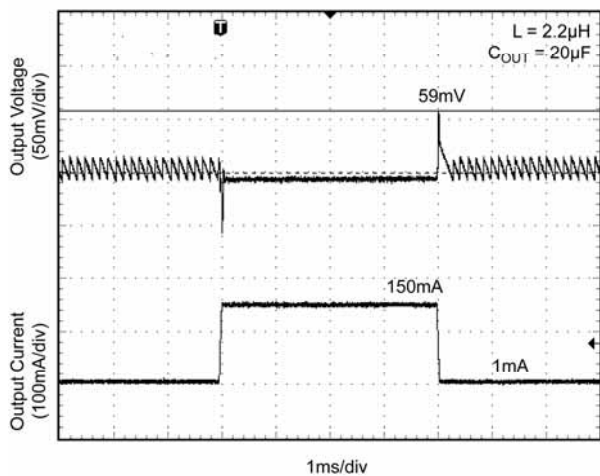

Transient Response

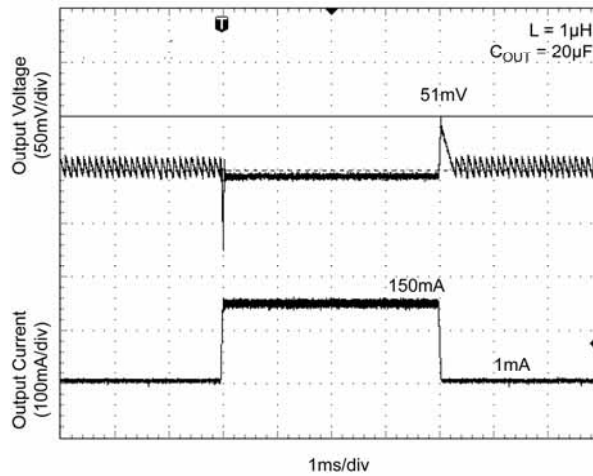

[查询"MIC2238"供应商](#)

Functional Block Diagram

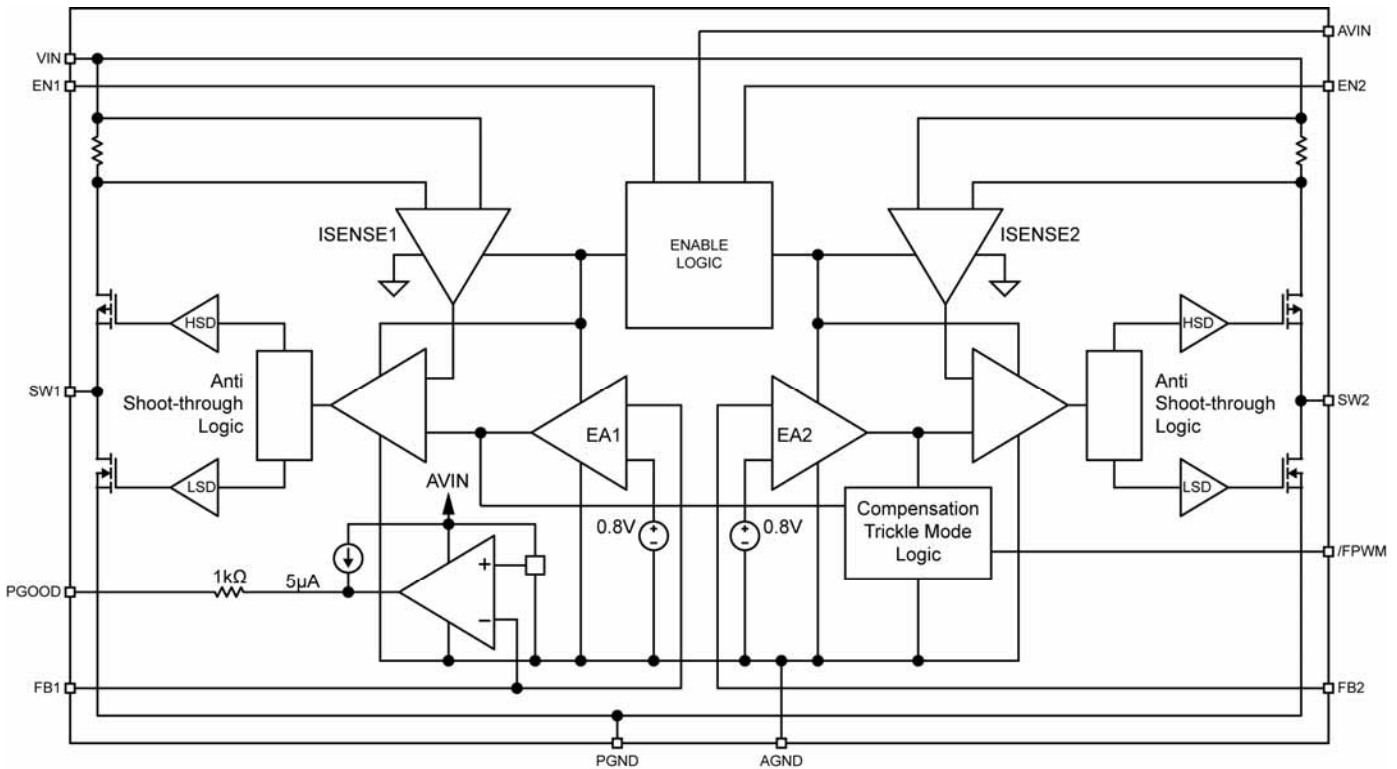

Functional Description

VIN

VIN provides power to the MOSFETs for the switch mode regulator section, along with the current limiting sensing. Due to the high switching speeds, a 10μF capacitor is recommended close to VIN and the power ground (PGND) pin for bypassing. Please refer to layout recommendations.

AVIN

Analog V_{IN} (AVIN) provides power to the analog supply circuitry. AVIN and VIN must be tied together. Careful layout should be considered to ensure high frequency switching noise caused by VIN is reduced before reaching AVIN. A 1μF capacitor as close to AVIN as possible is recommended. See layout recommendations for detail.

EN1

Enable 1 controls the on and off state of regulator 1. A high logic on Enable 1 (EN1) activates regulator 1 while a low logic deactivates regulator 1. MIC2238 features built-in soft-start circuitry that reduces in-rush current and prevents the output voltage from overshooting at start up.

EN2

Enable 2 controls the on and off state of regulator 2. A high logic on Enable 2 (EN2) activates regulator 2 while a low logic deactivates regulator 2. MIC2238 features built-in soft-start circuitry that reduces in-rush current and prevents the output voltage from overshooting at start up.

/FPWM

The Forced PWM Mode selects the mode of operation for this device. Grounding this pin forces the device to stay in constant frequency PWM mode only. Pulling this pin high enables automatic selection of Trickle or PWM mode operation, depending on the load. While /FPWM is high and the load is below 100mA, the device will go into Trickle mode. If the load is above 100mA, PWM mode will automatically be selected. Do not leave this pin floating.

PGOOD

The Power Good Output is pulled down unless the regulator 1 output voltage is within +6.25% or -8.5% of regulation. After the output voltage is in regulation, the output starts to go high with an internal 5μA current source. A delay time could be programmed by tying a capacitor to this pin. Using the circuit in Figure 1, if the NFET is off and the input voltage is at 5 volts, a 390pF

[查询"MIC2238"供应商](#)

external capacitor at the PGOOD pin will cause the PGOOD pin voltage to rise from low to high in around 390 μ s.

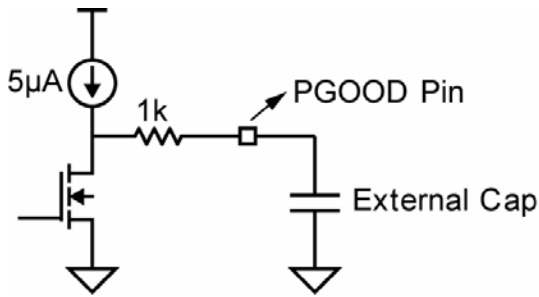

Figure 1. Power Good Circuit

FB1/FB2

The feedback pin (FB) provides the control path to control the output. For adjustable versions, a resistor divider connecting the feedback to the output is used to adjust the desired output voltage. The output voltage is calculated as follows:

$$V_{OUT} = V_{REF} \times \left(\frac{R1}{R2} + 1 \right)$$

where V_{REF} is equal to 0.8V.

A feedforward capacitor is recommended for most designs using the adjustable output voltage option. To reduce battery current draw, a 100k Ω feedback resistor is recommended for use from the output to the FB pin (R1). Also, a feedforward capacitor should be

connected between the output and feedback (across R1). The large resistor value and the parasitic capacitance of the FB pin can cause a high frequency pole that can reduce the overall system phase margin. By placing a feedforward capacitor, these effects can be significantly reduced. Typically, a 22pF small ceramic capacitor is recommended.

SW1/SW2

The switch (SW) pin connects directly to the inductor and provides the switching current necessary to operate in PWM mode. Due to the high speed switching on this pin, the switch node should be routed away from sensitive nodes.

PGND

Power ground (PGND) is the ground path for the high current PWM mode. The current loop for the power ground should be as small as possible and separate from the Analog ground (AGND) loop. Refer to the layout considerations for more details.

AGND

Signal ground (AGND) is the ground path for the biasing and control circuitry. The current loop for the signal ground should be separate from the Power ground (PGND) loop. Refer to the layout considerations for more details.

[查询"MIC2238"供应商](#)

Applications Information

Input Capacitor

A minimum 2.2μF ceramic is recommended on the VIN pin for bypassing. X5R or X7R dielectrics are recommended for the input capacitor. Y5V dielectrics, aside from losing most of their capacitance over temperature, they also become resistive at high frequencies. This reduces their ability to filter out high frequency noise.

Output Capacitor

The MIC2238 was designed specifically for use with a 2.2μF or greater ceramic output capacitor. The output capacitor requires either an X7R or X5R dielectric. Y5V and Z5U dielectric capacitors, aside from the undesirable effect of their wide variation in capacitance over temperature, become resistive at high frequencies.

Inductor Selection

Inductor selection will be determined by the following (not necessarily in the order of importance);

- Inductance
- Rated current value
- Size requirements
- DC resistance (DCR)

The MIC2238 was designed for use with a 1μH, 2.2μH, or 4.7μH inductor. For a better load transient response, a 1μH inductor is recommended. For better efficiency, a 4.7μH inductor is recommended.

Maximum current ratings of the inductor are generally given in two methods; permissible DC current and saturation current. Permissible DC current can be rated either for a 40°C temperature rise or a 10 to 20% loss in inductance. Ensure the inductor selected can handle the maximum operating current. When saturation current is specified, make sure that there is enough margin that the peak current will not saturate the inductor.

The size requirements refer to the area and height requirements that are necessary to fit a particular design. Please refer to the inductor dimensions on their datasheet.

DC resistance is also important. While DCR is inversely proportional to size, DCR can represent a significant efficiency loss. *Refer to the Efficiency Considerations.*

Compensation

The MIC2238 is an internally compensated, current mode buck regulator. Current mode is achieved by sampling the peak current and using the output of the error amplifier to pulse width modulate the switch node and maintain output voltage regulation.

The MIC2238 is designed to be stable with a 1μH, 2.2μH

or 4.7μH inductor with a 2.2μF ceramic (X5R) output capacitor.

Feedback

The MIC2238 provides a feedback pin to adjust the output voltage to the desired level. This pin connects internally to an error amplifier. The error amplifier then compares the voltage at the feedback to the internal 0.8V reference voltage and adjusts the output voltage to maintain regulation. Calculating the resistor divider network for the desired output is as follows;

$$R2 = \frac{R1}{\left(\frac{V_{OUT}}{V_{REF}} - 1\right)}$$

Where V_{REF} is 0.8V and V_{OUT} is the desired output voltage.

A 100kΩ from the output to the feedback is recommended for R1. Larger resistor values require an additional capacitor (feed-forward) from the output to the feedback. The large high-side resistor value and the parasitic capacitance on the feedback pin (~10pF) can cause an additional pole in the control loop. The additional pole can create a phase loss at high frequencies. This phase loss degrades transient response by reducing phase margin. Adding feed-forward capacitance negates the parasitic capacitive effects of the feedback pin. A minimum 100pF capacitor is recommended for feed forward capacitance.

Large feedback resistor values increase impedance, making the feedback node more susceptible to noise pick-up. A feed forward capacitor would also reduce noise pick-up by providing a low impedance path to the output.

Efficiency Considerations

Efficiency is defined as the amount of useful output power, divided by the amount of power supplied.

$$\text{Efficiency}_{\%} = \left(\frac{V_{OUT} \times I_{OUT}}{V_{IN} \times I_{IN}}\right) \times 100$$

Maintaining high efficiency serves two purposes. It reduces power dissipation in the power supply, reducing the need for heat sinks and thermal design considerations and it reduces consumption of current for battery powered applications. Reduced current draw from a battery increases the devices operating time and is critical in hand held devices.

There are two types of losses in switching converters; DC losses and switching losses. DC losses are simply the power dissipation of I^2R . Power is dissipated in the high-side switch during the on cycle. Power loss is equal to the high side MOSFET $R_{DS(on)}$ multiplied by the Switch

[查询"MIC2238"供应商](#)

Current. During the off cycle, the low side N-channel MOSFET conducts, also dissipating power. Device operating current also reduces efficiency. The product of the quiescent (operating) current and the supply voltage is another DC loss. The current required driving the gates on and off at a constant 2.5MHz frequency and the switching transitions make up the switching losses.

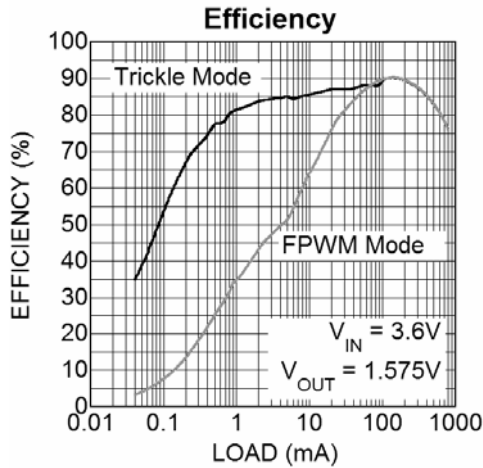

The figure above shows an efficiency curve. From no load to 100mA, efficiency losses are dominated by quiescent current losses, gate drive and transition losses. By forcing the MIC2238 into Trickle Mode (/FPWM=High), the buck regulator significantly reduces the required switching current by entering into a PFM (Pulse Frequency Modulation) mode. This significantly increases efficiency at low output currents.

Over 100mA, efficiency loss is dominated by MOSFET RDSON and inductor losses. Higher input supply voltages will increase the Gate to Source threshold on the internal MOSFETs, reducing the internal RDSON. This improves efficiency by reducing DC losses in the device. All but the inductor losses are inherent to the device. In which case, inductor selection becomes increasingly critical in efficiency calculations. As the inductors are reduced in size, the DC resistance (DCR)

can become quite significant. The DCR losses can be calculated as follows;

$$L_Pd = I_{out}^2 \times DCR$$

From that, the loss in efficiency due to inductor resistance can be calculated as follows;

$$Efficiency_Loss = \left[1 - \left(\frac{V_{OUT} \times I_{OUT}}{V_{OUT} \times I_{OUT} + L_Pd} \right) \right] \times 100$$

Efficiency loss due to DCR is minimal at light loads and gains significance as the load is increased. Inductor selection becomes a trade-off between efficiency and size in this case.

Trickle Mode Operation

Trickle Mode operation is achieved by clamping the minimum peak current to approximately 150mA. This forces a PFM mode by comparing the output voltage to the internal reference. If the voltage is less than 0.8V, the MIC2238 turns on the high side until the peak inductor current reaches approximately 150mA. A separate comparator then monitors the output voltage. If the feedback voltage is greater than 0.8V, the high side switch is then used as a 10µA current source, never turning off completely. This creates a highly efficient light load mode by increasing the time it takes for the output capacitor to discharge, delaying the amount of switching required and increasing light load efficiency. When the load current is greater than approximately 100mA, the MIC2238 automatically switches to PWM mode.

FPWM Operation

In forced PWM Mode (/FPWM=LOW) the MIC2238 is forced to provides constant switching at 2.5MHz with synchronous internal MOSFETs throughout the load current. In FPWM Mode, the output ripple can be as low as 7mV.

查询"MIC2238"供应商
MIC2238 Adjustable Option (1.8V, 1.8V)

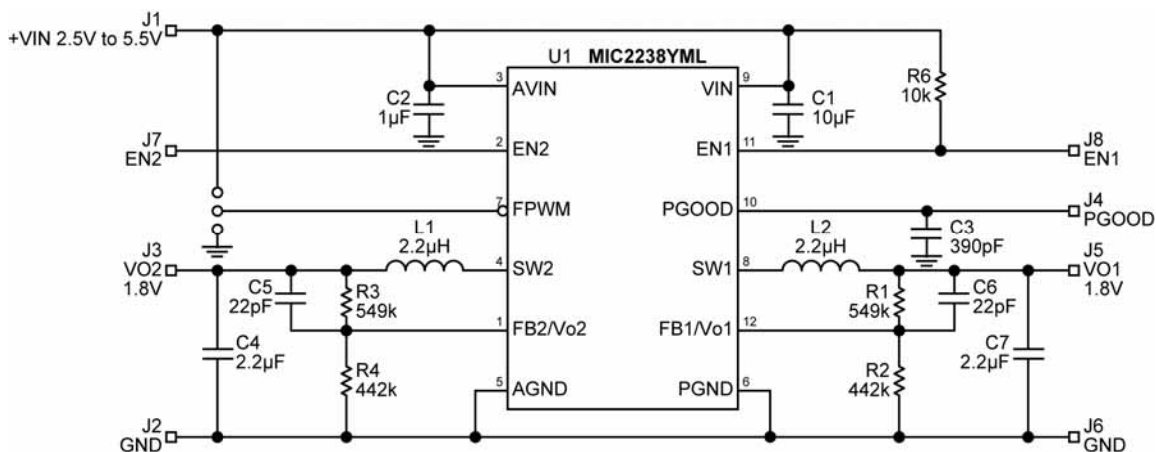

Bill of Materials

| Item | Part Number | Manufacturer | Description | Qty |
|--------|---------------------|--------------|---|-----|
| C1 | C1608X5R0J106K | TDK | 10µF Ceramic Capacitor, 6.3V, X5R, Size 0603 | 1 |
| C2 | C1005X5R0J105K | TDK | 1µF Ceramic Capacitor, 6.3V, X5R, Size 0402 | 1 |
| C3 | C0603Y391KXXA | Vishay | 390pF Ceramic Capacitor, 25V, X7R, Size 0603 | 1 |
| C4, C7 | 0603ZD225MAT | AVX | 2.2µF Ceramic Capacitor, 6.3V, X5R, Size 0603 | 2 |
| C5, C6 | VJ0603A220KXXAT | Vishay | 22pF Ceramic Capacitor, 25V, NPO, Size 0603 | 2 |
| L1, L2 | CDRH2D11/HPNP-2R2NC | Sumida | 2.2µH, 1.1A I _{SAT.} , 120mΩ, (1.2mm × 3.2mm × 3.2mm) | 2 |
| | LQH43CN2R2M03 | Murata | 2.2µH, 900mA I _{SAT.} , 110mΩ, (2.6mm × 3.2mm × 4.5mm) | |
| R2, R4 | CRCW06034423FT1 | Vishay | 442kΩ, 1%, Size 0603 | 2 |
| R1, R3 | CRCW06035493FT1 | Vishay | 549kΩ, 1%, Size 0603 | 2 |
| U1 | MIC2238-AAYML | Micrel | 2.5MHz Dual Phase PWM Buck Regulator | 1 |

1. TDK: www.tdk.com
2. Murata: www.murata.com
3. Sumida: www.sumida.com
4. Vishay-Dale: www.vishay.com
5. AVX: www.avx.com
6. **Micrel, Inc:** www.micrel.com

[查询"MIC2238"供应商](#)
Layout Recommendations

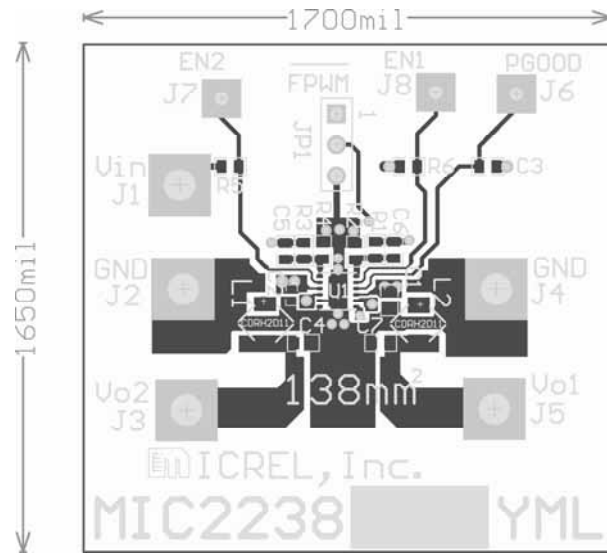

Top Layer

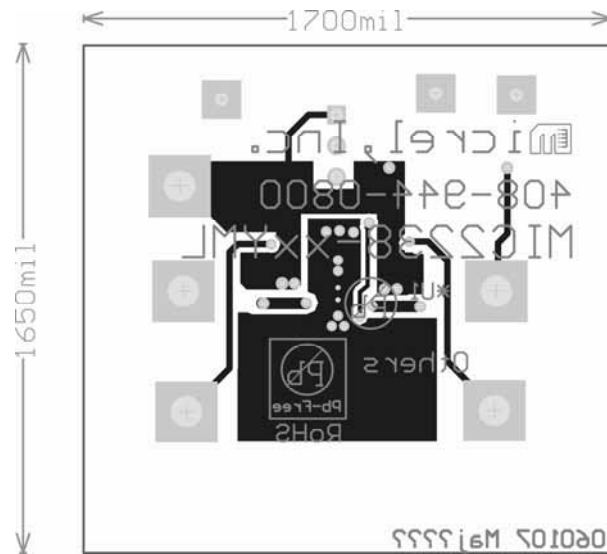

Bottom Layer

查询"MIC2238"供应商
Package Information

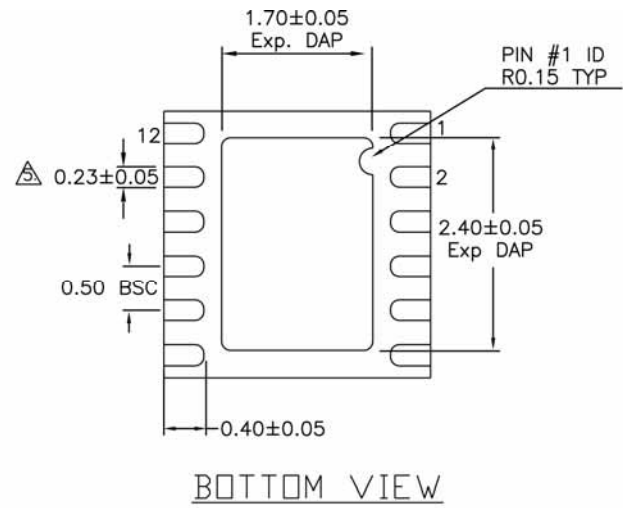
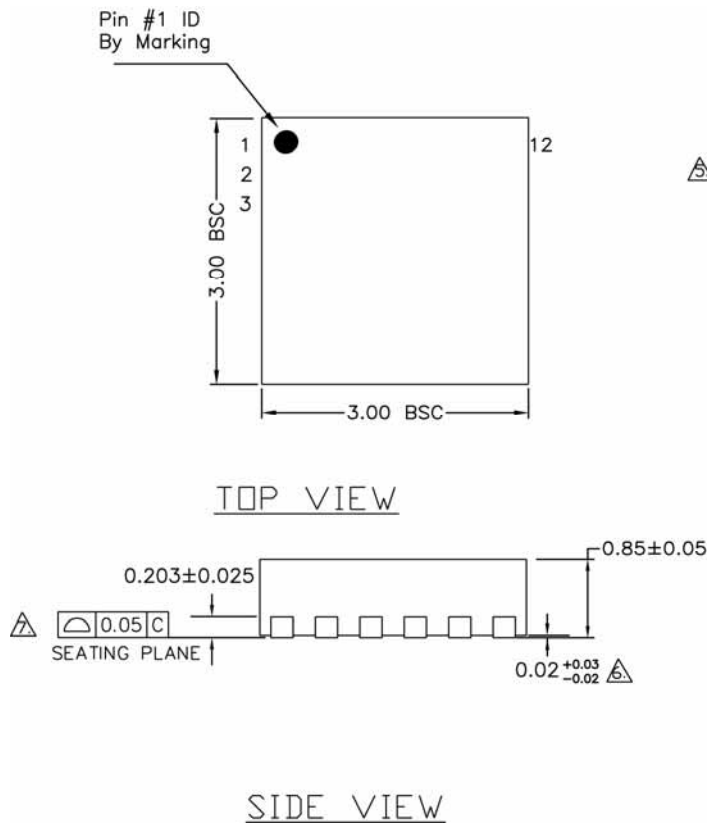

- NOTE:
1. ALL DIMENSIONS ARE IN MILLIMETERS.
 2. MAX. PACKAGE WARPAGE IS 0.05 mm.
 3. MAXIMUM ALLOWABLE BURRS IS 0.076 mm IN ALL DIRECTIONS.
 4. PIN #1 ID ON TOP WILL BE LASER/INK MARKED.
- △ DIMENSION APPLIES TO METALIZED TERMINAL AND IS MEASURED BETWEEN 0.20 AND 0.25 mm FROM TERMINAL TIP.
- △ APPLIED ONLY FOR TERMINALS.
- △ APPLIED FOR EXPOSED PAD AND TERMINALS.

12-Pin 3mm x 3mm MLF (ML)

MICREL, INC. 2180 FORTUNE DRIVE SAN JOSE, CA 95131 USA
 TEL +1 (408) 944-0800 FAX +1 (408) 474-1000 WEB <http://www.micrel.com>

The information furnished by Micrel in this data sheet is believed to be accurate and reliable. However, no responsibility is assumed by Micrel for its use. Micrel reserves the right to change circuitry and specifications at any time without notification to the customer.

Micrel Products are not designed or authorized for use as components in life support appliances, devices or systems where malfunction of a product can reasonably be expected to result in personal injury. Life support devices or systems are devices or systems that (a) are intended for surgical implant into the body or (b) support or sustain life, and whose failure to perform can be reasonably expected to result in a significant injury to the user. A Purchaser's use or sale of Micrel Products for use in life support appliances, devices or systems is a Purchaser's own risk and Purchaser agrees to fully indemnify Micrel for any damages resulting from such use or sale.

© 2007 Micrel, Incorporated.