

TLV277x, TLV277xA FAMILY OF 2.7-V HIGH-SLEW-RATE RAIL-TO-RAIL OUTPUT OPERATIONAL AMPLIFIERS WITH SHUTDOWN

SLOS209G – JANUARY 1998 – REVISED FEBRUARY 2004

查询"TLV2772"供应商

- High Slew Rate . . . 10.5 V/ μ s Typ
- High-Gain Bandwidth . . . 5.1 MHz Typ
- Supply Voltage Range 2.5 V to 5.5 V
- Rail-to-Rail Output
- 360 μ V Input Offset Voltage
- Low Distortion Driving 600- Ω 0.005% THD+N
- 1 mA Supply Current (Per Channel)
- 17 nV/ $\sqrt{\text{Hz}}$ Input Noise Voltage
- 2 pA Input Bias Current
- Characterized From $T_A = -55^\circ\text{C}$ to 125°C
- Available in MSOP and SOT-23 Packages
- Micropower Shutdown Mode . . . $I_{DD} < 1 \mu\text{A}$
- Available in Q-Temp Automotive High Reliability Automotive Applications Configuration Control / Print Support Qualification to Automotive Standards

description

The TLV277x CMOS operational amplifier family combines high slew rate and bandwidth, rail-to-rail output swing, high output drive, and excellent dc precision. The device provides 10.5 V/ μ s of slew rate and 5.1 MHz of bandwidth while only consuming 1 mA of supply current per channel. This ac performance is much higher than current competitive CMOS amplifiers. The rail-to-rail output swing and high output drive make these devices a good choice for driving the analog input or reference of analog-to-digital converters. These devices also have low distortion while driving a 600- Ω load for use in telecom systems.

These amplifiers have a 360- μ V input offset voltage, a 17 nV/ $\sqrt{\text{Hz}}$ input noise voltage, and a 2-pA input bias current for measurement, medical, and industrial applications. The TLV277x family is also specified across an extended temperature range (-40°C to 125°C), making it useful for automotive systems, and the military temperature range (-55°C to 125°C), for military systems.

These devices operate from a 2.5-V to 5.5-V single supply voltage and are characterized at 2.7 V and 5 V. The single-supply operation and low power consumption make these devices a good solution for portable applications. The following table lists the packages available.

FAMILY PACKAGE TABLE

DEVICE	NUMBER OF CHANNELS	PACKAGE TYPES								SHUTDOWN	UNIVERSAL EVM BOARD
		PDIP	CDIP	SOIC	SOT-23	TSSOP	MSOP	LCCC	CPAK		
TLV2770	1	8	—	8	—	—	8	—	—	Yes	Refer to the EVM Selection Guide (Lit# SLOU060)
TLV2771	1	—	—	8	5	—	—	—	—	—	
TLV2772	2	8	8	8	—	8	8	20	10	—	
TLV2773	2	14	—	14	—	—	10	—	—	Yes	
TLV2774	4	14	—	14	—	14	—	—	—	—	
TLV2775	4	16	—	16	—	16	—	—	—	Yes	

A SELECTION OF SINGLE-SUPPLY OPERATIONAL AMPLIFIER PRODUCTS†

DEVICE	V _{DD} (V)	BW (MHz)	SLEW RATE (V/ μ s)	I _{DD} (per channel) (μ A)	RAIL-TO-RAIL
TLV277X	2.5 – 6.0	5.1	10.5	1000	O
TLV247X	2.7 – 6.0	2.8	1.5	600	I/O
TLV245X	2.7 – 6.0	0.22	0.11	23	I/O
TLV246X	2.7 – 6.0	6.4	1.6	550	I/O

† All specifications measured at 5 V.



Please be aware that an important notice concerning availability, standard warranty, and use in critical applications of Texas Instruments semiconductor products and disclaimers thereto appears at the end of this data sheet.

This document contains information on products in more than one phase of development. The status of each device is indicated on the page(s) specifying its electrical characteristics.

 **TEXAS INSTRUMENTS**
WWW.TI.COM

Copyright © 1998–2004, Texas Instruments Incorporated
On products compliant to MIL-PRF-38535, all parameters are tested unless otherwise noted. On all other products, production processing does not necessarily include testing of all parameters.



TLV277x, TLV277xA

FAMILY OF 2.7-V HIGH-SLEW-RATE RAIL-TO-RAIL OUTPUT OPERATIONAL AMPLIFIERS WITH SHUTDOWN

SLOS096C JANUARY 1998 REVISION D FEBRUARY 2004

查看 TLV2772 样品

TLV2770 and TLV2771 AVAILABLE OPTIONS

T _A	V _{IOmax} AT 25°C (mV)	PACKAGED DEVICES			
		SMALL OUTLINE (D)	SOT-23 (DBV)	MSOP (DGK)	PLASTIC DIP (P)
0°C to 70°C	2.5	TLV2770CD TLV2771CD	— TLV2771CDBV	TLV2770CDGK† —	TLV2770CP —
-40°C to 125°C	2.5	TLV2770ID TLV2771ID	— TLV2771IDBV	TLV2770IDGK† —	TLV2770IP —
	1.6	TLV2770AID TLV2771AID	— —	— —	TLV2770AIP —

† This device is in the Product Preview stage of development. Please contact your local TI sales office for availability.

TLV2772 and TLV2773 AVAILABLE OPTIONS

T _A	V _{IOmax} AT 25°C (mV)	PACKAGED DEVICES				
		SMALL OUTLINE (D)	MSOP (DGK)	MSOP (DGS)	PLASTIC DIP (N)	PLASTIC DIP (P)
0°C to 70°C	2.5	TLV2772CD TLV2773CD	TLV2772CDGK —	— TLV2773CDGS	— TLV2773CN	TLV2772CP —
-40°C to 125°C	2.5	TLV2772ID TLV2773ID	TLV2772IDGK —	— TLV2773IDGS	— TLV2773IN	TLV2772IP —
	1.6	TLV2772AID TLV2773AID	— —	— —	— TLV2773AIN	TLV2772AIP —

TLV2774 and TLV2775 AVAILABLE OPTIONS

T _A	V _{IOmax} AT 25°C (mV)	PACKAGED DEVICES			
		SMALL OUTLINE (D)	PLASTIC DIP (N)	PLASTIC DIP (P)	TSSOP (PW)
0°C to 70°C	2.7	TLV2774CD TLV2775CD	— TLV2775CN	TLV2774CP —	TLV2774CPW TLV2775CPW
-40°C to 125°C	2.7	TLV2774ID TLV2775ID	— TLV2775IN	TLV2774IP —	TLV2774IPW TLV2775IPW
	2.1	TLV2774AID TLV2775AID	— TLV2775AIN	TLV2774AIP —	TLV2774AIPW TLV2775AIPW

TLV2772M/Q AND TLV2772AM/Q AVAILABLE OPTIONS

T _A	V _{IOmax} AT 25°C (mV)	PACKAGED DEVICES				
		SMALL OUTLINE (D)	CHIP CARRIER (FK)	CERAMIC DIP (JG)	CERAMIC FLATPACK (U)	TSSOP (PW)
-40°C to 125°C	2.5	TLV2772QD‡	—	—	—	TLV2772QPW‡
	1.6	TLV2772AQD‡	—	—	—	TLV2772AQPW‡
-55°C to 125°C	2.5	TLV2772MD	TLV2772MFK	TLV2772MJG	TLV2772MU	—
	1.6	TLV2772AMD	TLV2772AMFK	TLV2772AMJG	TLV2772AMU	—

‡ Available in tape and reel

TLV277x, TLV277xA

FAMILY OF 2.7-V HIGH-SLEW-RATE RAIL-TO-RAIL OUTPUT OPERATIONAL AMPLIFIERS WITH SHUTDOWN

SLOS209G – JANUARY 1998 – REVISED FEBRUARY 2004

[查询"TLV2772"供应商](#)

PACKAGE SYMBOLS

PACKAGE TYPE	PINS	PART NUMBER	SYMBOL†
SOT23	5 Pin	TLV2771CDBV	VAMC
		TLV2771IDBV	VAMI
MSOP	8 Pin	TLV2770CDGK	xxTIABO
		TLV2770IDGK	xxTIABP
		TLV2772CDGK	xxTIAAF
		TLV2772IDGK	xxTIAAG
	10 Pin	TLV2773CDGS	xxTIABQ
		TLV2773IDGS	xxTIABR

† xx represents the device date code.

TLV277x PACKAGE PINOUT

TLV2772M AND TLV2772AM FK PACKAGE (TOP VIEW)

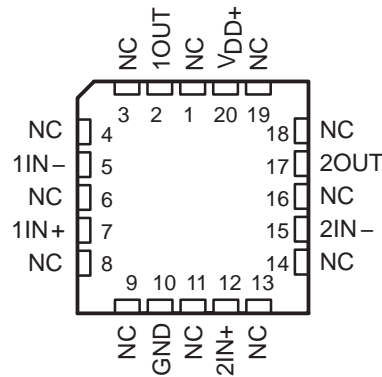

NC – No internal connection

TLV277x, TLV277xA FAMILY OF 2.7-V HIGH-SLEW-RATE RAIL-TO-RAIL OUTPUT OPERATIONAL AMPLIFIERS WITH SHUTDOWN

SLOS293G JANUARY 1998 REVISED FEBRUARY 2004

查看 TLV2772 样品商

TLV277x PACKAGE PINOUTS(1)

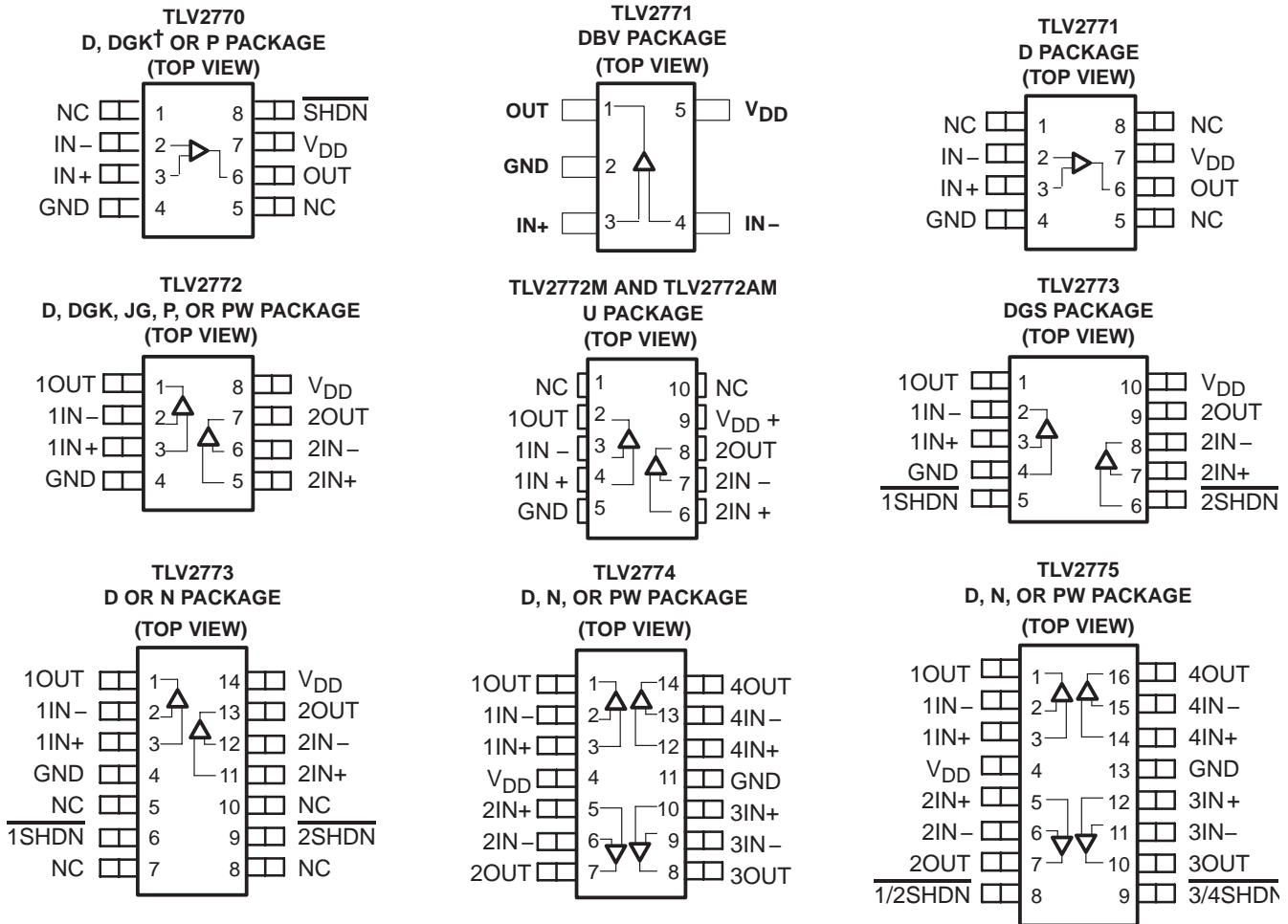

† This device is in the Product Preview stage of development. Please contact your local TI sales office for availability.

(1) SOT-23 may or may not be indicated

TYPICAL PIN 1 INDICATORS

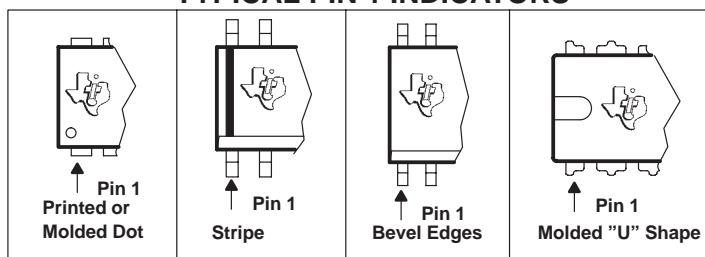

TLV277x, TLV277xA

FAMILY OF 2.7-V HIGH-SLEW-RATE RAIL-TO-RAIL OUTPUT OPERATIONAL AMPLIFIERS WITH SHUTDOWN

SLOS209G – JANUARY 1998 – REVISED FEBRUARY 2004

[查询"TLV2772"供应商](#)

absolute maximum ratings over operating free-air temperature range (unless otherwise noted)†

Supply voltage, V_{DD} (see Note 1)	7 V
Differential input voltage, V_{ID} (see Note 2)	$\pm V_{DD}$
Input voltage range, V_I (any input, see Note 1)	-0.3 V to V_{DD}
Input current, I_I (any input)	± 4 mA
Output current, I_O	± 50 mA
Total current into V_{DD+}	± 50 mA
Total current out of GND	± 50 mA
Duration of short-circuit current (at or below) 25°C (see Note 3)	unlimited
Continuous total power dissipation	See Dissipation Rating Table
Operating free-air temperature range, T_A : C suffix	0°C to 70°C
I suffix	-40°C to 125°C
Q suffix	-40°C to 125°C
M suffix	-55°C to 125°C
Storage temperature range, T_{stg}	-65°C to 150°C
Lead temperature 1,6 mm (1/16 inch) from case for 10 seconds	260°C

† Stresses beyond those listed under "absolute maximum ratings" may cause permanent damage to the device. These are stress ratings only, and functional operation of the device at these or any other conditions beyond those indicated under "recommended operating conditions" is not implied. Exposure to absolute-maximum-rated conditions for extended periods may affect device reliability.

- NOTES:
- All voltage values, except differential voltages, are with respect to GND.
 - Differential voltages are at the noninverting input with respect to the inverting input. Excessive current flows when input is brought below GND - 0.3 V.
 - The output may be shorted to either supply. Temperature and/or supply voltages must be limited to ensure that the maximum dissipation rating is not exceeded.

DISSIPATION RATING TABLE

PACKAGE	$T_A \leq 25^\circ\text{C}$ POWER RATING	DERATING FACTOR ABOVE $T_A = 25^\circ\text{C}$	$T_A = 70^\circ\text{C}$ POWER RATING	$T_A = 85^\circ\text{C}$ POWER RATING	$T_A = 125^\circ\text{C}$ POWER RATING
D	725 mW	5.8 mW/°C	464 mW	377 mW	145 mW
DBV	437 mW	3.5 mW/°C	280 mW	227 mW	87 mW
DGK	424 mW	3.4 mW/°C	271 mW	220 mW	85 mW
DGS	424 mW	3.4 mW/°C	271 mW	220 mW	85 mW
FK	1375 mW	11.0 mW/°C	672 mW	546 mW	210 mW
JG	1050 mW	8.4 mW/°C	880 mW	714 mW	275 mW
N	1150 mW	9.2 mW/°C	736 mW	598 mW	230 mW
P	1000 mW	8.0 mW/°C	640 mW	520 mW	200 mW
PW	700 mW	5.6 mW/°C	448 mW	364 mW	140 mW
U	675 mW	5.4 mW/°C	432 mW	350 mW	135 mW

recommended operating conditions

	C SUFFIX		I SUFFIX		Q SUFFIX		M SUFFIX		UNIT
	MIN	MAX	MIN	MAX	MIN	MAX	MIN	MAX	
Supply voltage, V_{DD}	2.5	6	2.5	6	2.5	6	2.5	6	V
Input voltage range, V_I	GND	$V_{DD+} - 1.3$	GND	$V_{DD+} - 1.3$	GND	$V_{DD+} - 1.3$	GND	$V_{DD+} - 1.3$	V
Common-mode input voltage, V_{IC}	GND	$V_{DD+} - 1.3$	GND	$V_{DD+} - 1.3$	GND	$V_{DD+} - 1.3$	GND	$V_{DD+} - 1.3$	V
Operating free-air temperature, T_A	0	70	-40	125	-40	125	-55	125	°C

TLV277x, TLV277xA

FAMILY OF 2.7-V HIGH-SLEW-RATE RAIL-TO-RAIL OUTPUT OPERATIONAL AMPLIFIERS WITH SHUTDOWN

SLOS296 "TLV277x" 1998 REVISED FEBRUARY 2004

electrical characteristics at specified free-air temperature, $V_{DD} = 2.7$ V (unless otherwise noted)

PARAMETER		TEST CONDITIONS	T_A †	TLV277xC			UNIT
				MIN	TYP	MAX	
V_{IO}	Input offset voltage	$V_{IC} = 0,$ $R_S = 50 \Omega,$ No load	$V_O = 0,$ $V_{DD} = \pm 1.35$ V,	25°C	0.48	2.5	mV
				Full range	0.53	2.7	
				25°C	0.8	2.7	
				Full range	0.86	2.9	
α_{VIO}	Temperature coefficient of input offset voltage			25°C to 125°C	2		$\mu\text{V}/^\circ\text{C}$
I_{IO}	Input offset current	$V_{IC} = 0,$ $R_S = 50 \Omega$	$V_O = 0,$ $V_{DD} = \pm 1.35$ V	25°C	1	60	pA
				Full range	2	100	
I_{IB}	Input bias current			25°C	2	60	pA
				Full range	6	100	
V_{OH}	High-level output voltage	$I_{OH} = -0.675$ mA		25°C	2.6		V
				Full range	2.5		
		$I_{OH} = -2.2$ mA		25°C	2.4		
				Full range	2.1		
V_{OL}	Low-level output voltage	$V_{IC} = 1.35$ V,	$I_{OL} = 0.675$ mA	25°C	0.1		V
				Full range	0.2		
		$V_{IC} = 1.35$ V,	$I_{OL} = 2.2$ mA	25°C	0.21		
				Full range	0.6		
A_{VD}	Large-signal differential voltage amplification	$V_{IC} = 1.35$ V, $V_O = 0.6$ V to 2.1 V	$R_L = 10$ k Ω ,	25°C	20	380	V/mV
				Full range	13		
$r_{i(d)}$	Differential input resistance			25°C	10 ¹²		Ω
$c_{i(c)}$	Common-mode input capacitance	$f = 10$ kHz		25°C	8		pF
z_o	Closed-loop output impedance	$f = 100$ kHz,	$A_V = 10$	25°C	25		Ω
CMRR	Common-mode rejection ratio	$V_{IC} = 0$ to 1.5 V, $R_S = 50 \Omega$	$V_O = V_{DD}/2,$	25°C	60	84	dB
				Full range	60	82	
k_{SVR}	Supply voltage rejection ratio ($\Delta V_{DD} / \Delta V_{IO}$)	$V_{DD} = 2.7$ V to 5 V, No load	$V_{IC} = V_{DD}/2,$	25°C	70	89	dB
				Full range	70	84	
I_{DD}	Supply current (per channel)	$V_O = V_{DD}/2,$	No load	25°C	1	2	mA
				Full range	2		
$I_{DD}(\text{SHDN})$	Supply current in shutdown (per channel)			25°C	0.8	1.5	μA
				Full range	1.3	2	
$V_{(ON)}$	Turnon voltage level	TLV2770	$A_V = 5$	25°C	1.47		V
		TLV2773			1.43		
		TLV2775			1.40		
$V_{(OFF)}$	Turnoff voltage level	TLV2770	$A_V = 5$	25°C	1.27		V
		TLV2773			1.21		
		TLV2775			1.20		

† Full range is 0°C to 70°C.

TLV277x, TLV277xA
FAMILY OF 2.7-V HIGH-SLEW-RATE RAIL-TO-RAIL OUTPUT
OPERATIONAL AMPLIFIERS WITH SHUTDOWN

SLOS209G – JANUARY 1998 – REVISED FEBRUARY 2004

[查询"TLV2772"供应商](#)

operating characteristics at specified free-air temperature, $V_{DD} = 2.7\text{ V}$ (unless otherwise noted)

PARAMETER		TEST CONDITIONS		T_A †	TLV277xC			UNIT
					MIN	TYP	MAX	
SR	Slew rate at unity gain	$V_{O(PP)} = 0.8\text{ V}$, $R_L = 10\text{ k}\Omega$	$C_L = 100\text{ pF}$	25°C	5	9	V/ μs	
				Full range	4.7	6		
V_n	Equivalent input noise voltage			25°C	21		nV/ $\sqrt{\text{Hz}}$	
				25°C	17			
$V_{N(PP)}$	Peak-to-peak equivalent input noise voltage			25°C	0.33		μV	
					0.86			
I_n	Equivalent input noise current		$f = 100\text{ Hz}$	25°C	0.6		fA/ $\sqrt{\text{Hz}}$	
THD + N	Total harmonic distortion plus noise	$R_L = 600\ \Omega$, $f = 1\text{ kHz}$		25°C	$A_V = 1$	0.0085%		
					$A_V = 10$	0.025%		
					$A_V = 100$	0.12%		
Gain-bandwidth product			$f = 10\text{ kHz}$, $C_L = 100\text{ pF}$	$R_L = 600\ \Omega$, 25°C	4.8		MHz	
t_s	Settling time	$A_V = -1$, Step = 1 V, $R_L = 600\ \Omega$, $C_L = 100\text{ pF}$		25°C	0.1%	0.186		μs
				25°C	0.01%	0.3		
ϕ_m	Phase margin at unity gain			25°C	46°			
	Gain margin	$R_L = 600\ \Omega$,	$C_L = 100\text{ pF}$	25°C	12		dB	

† Full range is 0°C to 70°C.

TLV277x, TLV277xA FAMILY OF 2.7-V HIGH-SLEW-RATE RAIL-TO-RAIL OUTPUT OPERATIONAL AMPLIFIERS WITH SHUTDOWN

SLOS296 "TLV277" (共) 2004 FEBRUARY 2004

electrical characteristics at specified free-air temperature, $V_{DD} = 5\text{ V}$ (unless otherwise noted)

PARAMETER		TEST CONDITIONS	T_A †	TLV277xC			UNIT
				MIN	TYP	MAX	
V_{IO}	Input offset voltage	$V_{IC} = 0,$ $R_S = 50\ \Omega,$ No load	$V_O = 0,$ $V_{DD} = \pm 2.5\text{ V},$	25°C	0.5	2.5	mV
				Full range	0.6	2.7	
				25°C	0.7	2.5	
				Full range	0.78	2.7	
α_{VIO}	Temperature coefficient of input offset voltage			25°C to 125°C	2		$\mu\text{V}/^\circ\text{C}$
I_{IO}	Input offset current	$V_{IC} = 0,$ $R_S = 50\ \Omega$	$V_O = 0,$ $V_{DD} = \pm 2.5\text{ V}$	25°C	1	60	pA
				Full range	2	100	
I_{IB}	Input bias current			25°C	2	60	pA
				Full range	6	100	
V_{OH}	High-level output voltage	$I_{OH} = -1.3\text{ mA}$		25°C	4.9	V	
				Full range	4.8		
		$I_{OH} = -4.2\text{ mA}$		25°C	4.7		
				Full range	4.4		
V_{OL}	Low-level output voltage	$V_{IC} = 2.5\text{ V},$	$I_{OL} = 1.3\text{ mA}$	25°C	0.1	V	
				Full range	0.2		
		$V_{IC} = 2.5\text{ V},$	$I_{OL} = 4.2\text{ mA}$	25°C	0.21		
				Full range	0.6		
A_{VD}	Large-signal differential voltage amplification	$V_{IC} = 2.5\text{ V},$ $V_O = 1\text{ V to }4\text{ V}$	$R_L = 10\text{ k}\Omega,$	25°C	20	450	V/mV
				Full range	13		
$r_{i(d)}$	Differential input resistance			25°C	10 ¹²	Ω	
$c_{i(c)}$	Common-mode input capacitance	$f = 10\text{ kHz}$		25°C	8	pF	
z_o	Closed-loop output impedance	$f = 100\text{ kHz},$	$A_V = 10$	25°C	20	Ω	
CMRR	Common-mode rejection ratio	$V_{IC} = 0\text{ to }3.7\text{ V},$ $R_S = 50\ \Omega$	$V_O = V_{DD}/2,$	25°C	70	96	dB
				Full range	70	93	
k_{SVR}	Supply voltage rejection ratio ($\Delta V_{DD} / \Delta V_{IO}$)	$V_{DD} = 2.7\text{ V to }5\text{ V},$ No load	$V_{IC} = V_{DD}/2,$	25°C	70	89	dB
				Full range	70	84	
I_{DD}	Supply current (per channel)	$V_O = V_{DD}/2,$	No load	25°C	1	2	mA
				Full range		2	
$I_{DD(SHDN)}$	Supply current in shutdown (per channel)			25°C	0.8	1.5	μA
				Full range	1.3	2	
$V_{(ON)}$	Turnon voltage level	TLV2770	$A_V = 5$	25°C	2.59	V	
		TLV2773			2.47		
		TLV2775			2.48		
$V_{(OFF)}$	Turnoff voltage level	TLV2770	$A_V = 5$	25°C	2.41	V	
		TLV2773			2.32		
		TLV2775			2.29		

† Full range is 0°C to 70°C.

TLV277x, TLV277xA
FAMILY OF 2.7-V HIGH-SLEW-RATE RAIL-TO-RAIL OUTPUT
OPERATIONAL AMPLIFIERS WITH SHUTDOWN

SLOS209G – JANUARY 1998 – REVISED FEBRUARY 2004

[查询"TLV2772"供应商](#)

operating characteristics at specified free-air temperature, $V_{DD} = 5\text{ V}$ (unless otherwise noted)

PARAMETER		TEST CONDITIONS		T_A †	TLV277xC			UNIT
					MIN	TYP	MAX	
SR	Slew rate at unity gain	$V_{O(PP)} = 2\text{ V}$, $R_L = 10\text{ k}\Omega$	$C_L = 100\text{ pF}$	25°C	5	10.5	V/ μs	
				Full range	4.7	6		
V_n	Equivalent input noise voltage	f = 1 kHz		25°C	17		nV/ $\sqrt{\text{Hz}}$	
		f = 10 kHz		25°C	12			
$V_{N(PP)}$	Peak-to-peak equivalent input noise voltage	f = 0.1 Hz to 1 Hz		25°C	0.33		μV	
		f = 0.1 Hz to 10 Hz			0.86			
I_n	Equivalent input noise current	f = 100 Hz		25°C	0.6		fA/ $\sqrt{\text{Hz}}$	
THD + N	Total harmonic distortion plus noise	$R_L = 600\ \Omega$, f = 1 kHz		$A_V = 1$	25°C	0.005%		
				$A_V = 10$		0.016%		
				$A_V = 100$		0.095%		
Gain-bandwidth product		f = 10 kHz, $C_L = 100\text{ pF}$	$R_L = 600\ \Omega$	25°C	5.1		MHz	
t_s	Settling time	$A_V = -1$, Step = 2 V, $R_L = 600\ \Omega$, $C_L = 100\text{ pF}$		0.1%	25°C	0.335		μs
				0.01%	25°C	0.6		
ϕ_m	Phase margin at unity gain	$R_L = 600\ \Omega$, $C_L = 100\text{ pF}$		25°C	46°			
	Gain margin			25°C	12		dB	
$t_{(ON)}$	Amplifier turnon time	$A_V = 5$, $R_L = \text{Open}$, Measured to 50% point		25°C	1.2		μs	
					2.4			
					1.9			
$t_{(OFF)}$	Amplifier turnoff time	$A_V = 5$, $R_L = \text{Open}$, Measured to 50% point		25°C	335		ns	
					444			
					345			

† Full range is 0°C to 70°C.

TLV277x, TLV277xA

FAMILY OF 2.7-V HIGH-SLEW-RATE RAIL-TO-RAIL OUTPUT OPERATIONAL AMPLIFIERS WITH SHUTDOWN

SLOS296C JANUARY 1998 REVISED FEBRUARY 2004

查看 TLV277 系列器件

electrical characteristics at specified free-air temperature, $V_{DD} = 2.7\text{ V}$ (unless otherwise noted)

PARAMETER		TEST CONDITIONS	T_A †	TLV277xI			TLV277xAI			UNIT
				MIN	TYP	MAX	MIN	TYP	MAX	
V_{IO}	Input offset voltage	$V_{IC} = 0, V_O = 0,$ $R_S = 50\ \Omega$ $V_{DD} = \pm 1.35\text{ V},$ No load	25°C	0.48	2.5		0.48	1.6	mV	
			Full range	0.53	2.7		0.53	1.9		
			25°C	0.8	2.7		0.8	2.1		
			Full range	0.86	2.9		0.86	2.2		
α_{VIO}	Temperature coefficient of input offset voltage		25°C to 125°C	2			2			$\mu\text{V}/^\circ\text{C}$
I_{IO}	Input offset current	$V_{IC} = 0, V_O = 0,$ $R_S = 50\ \Omega$	25°C	1	60		1	60	pA	
			Full range	2	125		2	125		
I_{IB}	Input bias current		25°C	2	60		2	60	pA	
			Full range	6	350		6	350		
V_{OH}	High-level output voltage	$I_{OH} = -0.675\text{ mA}$	25°C	2.6			2.6			V
			Full range	2.5			2.5			
		$I_{OH} = -2.2\text{ mA}$	25°C	2.4			2.4			
			Full range	2.1			2.1			
V_{OL}	Low-level output voltage	$V_{IC} = 1.35\text{ V},$ $I_{OL} = 0.675\text{ mA}$	25°C	0.1			0.1			V
			Full range	0.2			0.2			
		$V_{IC} = 1.35\text{ V},$ $I_{OL} = 2.2\text{ mA}$	25°C	0.21			0.21			
			Full range	0.6			0.6			
A_{VD}	Large-signal differential voltage amplification	$V_{IC} = 1.35\text{ V},$ $R_L = 10\text{ k}\Omega,$ $V_O = 0.6\text{ V to } 2.1\text{ V}$	25°C	20	380		20	380	V/mV	
			Full range	13			13			
$r_{i(d)}$	Differential input resistance		25°C	10^{12}			10^{12}			Ω
$c_{i(c)}$	Common-mode input capacitance	$f = 10\text{ kHz},$	25°C	8			8			pF
z_o	Closed-loop output impedance	$f = 100\text{ kHz},$ $A_V = 10$	25°C	25			25			Ω
CMRR	Common-mode rejection ratio	$V_{IC} = 0\text{ to } 1.5\text{ V},$ $V_O = V_{DD}/2,$ $R_S = 50\ \Omega$	25°C	60	84		60	84	dB	
			Full range	60	82		60	82		
k_{SVR}	Supply voltage rejection ratio ($\Delta V_{DD} / \Delta V_{IO}$)	$V_{DD} = 2.7\text{ V to } 5\text{ V},$ $V_{IC} = V_{DD}/2,$ No load	25°C	70	89		70	89	dB	
			Full range	70	84		70	84		
I_{DD}	Supply current (per channel)	$V_O = V_{DD}/2,$ No load	25°C	1	2		1	2	mA	
			Full range	2			2			
$I_{DD(SHDN)}$	Supply current in shutdown (per channel)		25°C	0.8	1.5		0.8	1.5	μA	
			Full range	1.3	2		1.3	2		

† Full range is -40°C to 125°C .

TLV277x, TLV277xA
FAMILY OF 2.7-V HIGH-SLEW-RATE RAIL-TO-RAIL OUTPUT
OPERATIONAL AMPLIFIERS WITH SHUTDOWN

SLOS209G – JANUARY 1998 – REVISED FEBRUARY 2004

[查询"TLV2772"供应商](#)

electrical characteristics at specified free-air temperature, $V_{DD} = 2.7\text{ V}$ (unless otherwise noted)
(continued)

PARAMETER		TEST CONDITIONS	T_A^\dagger	TLV277xI			TLV277xAI			UNIT	
				MIN	TYP	MAX	MIN	TYP	MAX		
$V_{(ON)}$	Turnon voltage level	TLV2770	$A_V = 5$	25°C	1.47			1.47			V
		TLV2773			1.43			1.43			
		TLV2775			1.40			1.4			
$V_{(OFF)}$	Turnoff voltage level	TLV2770	$A_V = 5$	25°C	1.27			1.27			V
		TLV2773			1.21			1.21			
		TLV2775			1.20			1.2			

† Full range is -40°C to 125°C .

operating characteristics at specified free-air temperature, $V_{DD} = 2.7\text{ V}$ (unless otherwise noted)

PARAMETER		TEST CONDITIONS		T_A^\dagger	TLV277xI			TLV277xAI			UNIT	
					MIN	TYP	MAX	MIN	TYP	MAX		
SR	Slew rate at unity gain	$V_{O(PP)} = 0.8\text{ V}$, $C_L = 100\text{ pF}$, $R_L = 10\text{ k}\Omega$		25°C	5	9		5	9		V/ μs	
				Full range	4.7	6		4.7	6			
V_n	Equivalent input noise voltage	f = 1 kHz		25°C	21			21			nV/ $\sqrt{\text{Hz}}$	
		f = 10 kHz		25°C	17			17				
$V_{N(PP)}$	Peak-to-peak equivalent input noise voltage	f = 0.1 Hz to 1 Hz		25°C	0.33			0.33			μV	
		f = 0.1 Hz to 10 Hz		25°C	0.86			0.86			μV	
I_n	Equivalent input noise current	f = 100 Hz		25°C	0.6			0.6			fA/ $\sqrt{\text{Hz}}$	
THD + N	Total harmonic distortion plus noise	$R_L = 600\ \Omega$, f = 1 kHz		$A_V = 1$	25°C	0.0085%			0.0085%			
				$A_V = 10$		0.025%			0.025%			
				$A_V = 100$		0.12%			0.12%			
	Gain-bandwidth product	f = 10 kHz, $C_L = 100\text{ pF}$	$R_L = 600\ \Omega$	25°C	4.8			4.8			MHz	
t_s	Settling time	$A_V = -1$, Step = 0.85 V to 1.85 V, $R_L = 600\ \Omega$, $C_L = 100\text{ pF}$		0.1%	25°C	0.186			0.186			μs
				0.01%	25°C	3.92			3.92			
ϕ_m	Phase margin at unity gain	$R_L = 600\ \Omega$, $C_L = 100\text{ pF}$		25°C	46°			46°				
	Gain margin			25°C	12			12				dB

† Full range is -40°C to 125°C .

TLV277x, TLV277xA FAMILY OF 2.7-V HIGH-SLEW-RATE RAIL-TO-RAIL OUTPUT OPERATIONAL AMPLIFIERS WITH SHUTDOWN

SLOS296C JANUARY 1998 REVISED FEBRUARY 2004

查询TLV2772(共4页)

electrical characteristics at specified free-air temperature, $V_{DD} = 5\text{ V}$ (unless otherwise noted)

PARAMETER		TEST CONDITIONS	T_A †	TLV277xI			TLV277xAI			UNIT
				MIN	TYP	MAX	MIN	TYP	MAX	
V_{IO}	Input offset voltage	$V_{IC} = 0$, No load $V_O = 0$, $R_S = 50\ \Omega$, $V_{DD} = \pm 2.5\text{ V}$	25°C	0.5	2.5		0.5	1.6	mV	
			Full range	0.6	2.7		0.6	1.9		
			25°C	0.7	2.5		0.7	2.1		
			Full range	0.78	2.7		0.78	2.2		
α_{VIO}	Temperature coefficient of input offset voltage		25°C to 125°C	2		2		$\mu\text{V}/^\circ\text{C}$		
I_{IO}	Input offset current	$V_{IC} = 0$, $V_O = 0$, $R_S = 50\ \Omega$, $V_{DD} = \pm 2.5\text{ V}$	25°C	1	60		1	60	pA	
			Full range	2	125		2	125		
I_{IB}	Input bias current	$V_{IC} = 0$, $V_O = 0$, $R_S = 50\ \Omega$, $V_{DD} = \pm 2.5\text{ V}$	25°C	2	60		2	60	pA	
			Full range	6	350		6	350		
V_{OH}	High-level output voltage	$I_{OH} = -1.3\text{ mA}$	25°C	4.9		4.9		V		
			Full range	4.8		4.8				
			25°C	4.7		4.7				
			Full range	4.4		4.4				
V_{OL}	Low-level output voltage	$V_{IC} = 2.5\text{ V}$, $I_{OL} = 1.3\text{ mA}$	25°C	0.1		0.1		V		
			Full range	0.2		0.2				
			25°C	0.21		0.21				
			Full range	0.6		0.6				
A_{VD}	Large-signal differential voltage amplification	$V_{IC} = 2.5\text{ V}$, $R_L = 10\text{ k}\Omega$, $V_O = 1\text{ V to }4\text{ V}$	25°C	20	450		20	450	V/mV	
			Full range	13		13				
$r_{i(d)}$	Differential input resistance		25°C	10^{12}		10^{12}		Ω		
$C_{i(c)}$	Common-mode input capacitance	$f = 10\text{ kHz}$	25°C	8		8		pF		
z_o	Closed-loop output impedance	$f = 100\text{ kHz}$, $A_V = 10$	25°C	20		20		Ω		
CMRR	Common-mode rejection ratio	$V_{IC} = 0\text{ to }3.7\text{ V}$, $V_O = V_{DD}/2$, $R_S = 50\ \Omega$	25°C	60	96		70	96	dB	
			Full range	60	93		70	93		
k_{SVR}	Supply voltage rejection ratio ($\Delta V_{DD} / \Delta V_{IO}$)	$V_{DD} = 2.7\text{ V to }5\text{ V}$, $V_{IC} = V_{DD}/2$, No load	25°C	70	89		70	89	dB	
			Full range	70	84		70	84		
I_{DD}	Supply current (per channel)	$V_O = V_{DD}/2$, No load	25°C	1	2		1	2	mA	
			Full range	2		2				
$I_{DD(SHDN)}$	Supply current shutdown (per channel)		25°C	0.8	1.5		0.8	1.5	μA	
			Full range	1.3	2		1.3	2		

† Full range is -40°C to 125°C .

TLV277x, TLV277xA
FAMILY OF 2.7-V HIGH-SLEW-RATE RAIL-TO-RAIL OUTPUT
OPERATIONAL AMPLIFIERS WITH SHUTDOWN

SLOS209G – JANUARY 1998 – REVISED FEBRUARY 2004

[查询"TLV2772"供应商](#)

electrical characteristics at specified free-air temperature, $V_{DD} = 5\text{ V}$ (unless otherwise noted)
(continued)

PARAMETER		TEST CONDITIONS	T_A^\dagger	TLV277xI			TLV277xAI			UNIT	
				MIN	TYP	MAX	MIN	TYP	MAX		
$V_{(ON)}$	Turnon voltage level	TLV2770	$A_V = 5$	25°C	2.59			2.59			V
		TLV2773			2.47			2.47			
		TLV2775			2.48			2.48			
$V_{(OFF)}$	Turnoff voltage level	TLV2770	$A_V = 5$	25°C	2.41			2.41			V
		TLV2773			2.32			2.32			
		TLV2775			2.29			2.29			

† Full range is -40°C to 125°C .

operating characteristics at specified free-air temperature, $V_{DD} = 5\text{ V}$ (unless otherwise noted)

PARAMETER		TEST CONDITIONS		T_A^\dagger	TLV277xI			TLV277xAI			UNIT	
					MIN	TYP	MAX	MIN	TYP	MAX		
SR	Slew rate at unity gain	$V_{O(PP)} = 1.5\text{ V}$, $C_L = 100\text{ pF}$, $R_L = 10\text{ k}\Omega$		25°C	5	10.5		5	10.5		V/ μs	
				Full range	4.7	6		4.7	6			
V_n	Equivalent input noise voltage	$f = 1\text{ kHz}$		25°C	17			17			nV/ $\sqrt{\text{Hz}}$	
				25°C	12			12				
$V_{N(PP)}$	Peak-to-peak equivalent input noise voltage	$f = 0.1\text{ Hz to }1\text{ Hz}$		25°C	0.33			0.33			μV	
		$f = 0.1\text{ Hz to }10\text{ Hz}$		25°C	0.86			0.86			μV	
I_n	Equivalent input noise current	$f = 100\text{ Hz}$		25°C	0.6			0.6			fA/ $\sqrt{\text{Hz}}$	
THD + N	Total harmonic distortion plus noise	$R_L = 600\ \Omega$, $f = 1\text{ kHz}$		25°C	$A_V = 1$			0.005%				
					$A_V = 10$			0.016%				
					$A_V = 100$			0.095%				
Gain-bandwidth product		$f = 10\text{ kHz}$, $C_L = 100\text{ pF}$	$R_L = 600\ \Omega$	25°C	5.1			5.1			MHz	
t_s	Settling time	$A_V = -1$, Step = 1.5 V to 3.5 V, $R_L = 600\ \Omega$, $C_L = 100\text{ pF}$		0.1%	25°C	0.134			0.134			μs
				0.01%	25°C	1.97			1.97			
ϕ_m	Phase margin at unity gain	$R_L = 600\ \Omega$, $C_L = 100\text{ pF}$		25°C	46°			46°				
	Gain margin			25°C	12			12			dB	
$t_{(ON)}$	Amplifier turnon time	TLV2770	$A_V = 5$, $R_L = \text{Open}$, Measured to 50% point	25°C	1.2			1.2			μs	
		TLV2773			2.4			2.4				
		TLV2775			1.9			1.9				
$t_{(OFF)}$	Amplifier turnoff time	TLV2770	$A_V = 5$, $R_L = \text{Open}$, Measured to 50% point	25°C	335			335			ns	
		TLV2773			444			444				
		TLV2775			345			345				

† Full range is -40°C to 125°C .

TLV277x, TLV277xA

FAMILY OF 2.7-V HIGH-SLEW-RATE RAIL-TO-RAIL OUTPUT OPERATIONAL AMPLIFIERS WITH SHUTDOWN

SLOS096 " TLV277x 1998 REVISED FEBRUARY 2004

electrical characteristics at specified free-air temperature, $V_{DD} = 2.7\text{ V}$ (unless otherwise noted)

PARAMETER	TEST CONDITIONS	T_A †	TLV2772Q TLV2772M			TLV2772AQ TLV2772AM			UNIT
			MIN	TYP	MAX	MIN	TYP	MAX	
V_{IO} Input offset voltage		25°C	0.44	2.5		0.44	1.6	mV	
		Full range	0.47	2.7		0.47	1.9		
α_{VIO} Temperature coefficient of input offset voltage	$V_{DD} = \pm 1.35\text{ V}$, $V_{IC} = 0$, $R_S = 50\ \Omega$	$V_O = 0$, 25°C to 125°C	2			2			$\mu\text{V}/^\circ\text{C}$
I_{IO} Input offset current		25°C	1	60		1	60	pA	
	Full range	2	125		2	125			
I_{IB} Input bias current		25°C	2	60		2	60	pA	
		Full range	6	350		6	350		
V_{ICR} Common-mode input voltage range	CMRR > 60 dB, $R_S = 50\ \Omega$	25°C	0 to 1.4	-0.3 to 1.7		0 to 1.4	-0.3 to 1.7	V	
		Full range	0 to 1.4	-0.3 to 1.7		0 to 1.4	-0.3 to 1.7		
V_{OH} High-level output voltage	$I_{OH} = -0.675\text{ mA}$	25°C	2.6			2.6			V
		Full range	2.45			2.45			
	$I_{OH} = -2.2\text{ mA}$	25°C	2.4			2.4			
		Full range	2.1			2.1			
V_{OL} Low-level output voltage	$V_{IC} = 1.35\text{ V}$, $I_{OL} = 0.675\text{ mA}$	25°C	0.1			0.1			V
		Full range	0.2			0.2			
	$V_{IC} = 1.35\text{ V}$, $I_{OL} = 2.2\text{ mA}$	25°C	0.21			0.21			
		Full range	0.6			0.6			
A_{VD} Large-signal differential voltage amplification	$V_{IC} = 1.35\text{ V}$, $V_O = 0.6\text{ V to } 2.1\text{ V}$	$R_L = 10\text{ k}\Omega, \ddagger$	25°C	20	380		20	380	V/mV
			Full range	13			13		
$r_{i(d)}$ Differential input resistance		25°C	10^{12}			10^{12}			Ω
$C_{i(c)}$ Common-mode input capacitance	$f = 10\text{ kHz}$,	25°C	8			8			pF
z_o Closed-loop output impedance	$f = 100\text{ kHz}$, $A_V = 10$	25°C	25			25			Ω
CMRR Common-mode rejection ratio	$V_{IC} = V_{ICR}(\text{min})$, $R_S = 50\ \Omega$	$V_O = 1.5\text{ V}$,	25°C	60	84		60	84	dB
			Full range	60	82		60	82	
k_{SVR} Supply voltage rejection ratio ($\Delta V_{DD} / \Delta V_{IO}$)	$V_{DD} = 2.7\text{ V to } 5\text{ V}$, No load	$V_{IC} = V_{DD}/2$,	25°C	70	89		70	89	dB
			Full range	70	84		70	84	
I_{DD} Supply current (per channel)	$V_O = 1.5\text{ V}$, No load	25°C	1	2		1	2	mA	
		Full range		2			2		

† Full range is -40°C to 125°C for Q level part, -55°C to 125°C for M level part.

‡ Referenced to 1.35 V

TLV277x, TLV277xA
FAMILY OF 2.7-V HIGH-SLEW-RATE RAIL-TO-RAIL OUTPUT
OPERATIONAL AMPLIFIERS WITH SHUTDOWN

SLOS209G – JANUARY 1998 – REVISED FEBRUARY 2004

[查询"TLV2772"供应商](#)

operating characteristics at specified free-air temperature, $V_{DD} = 2.7\text{ V}$ (unless otherwise noted)

PARAMETER	TEST CONDITIONS	T_A †	TLV2772Q TLV2772M			TLV2772AQ TLV2772AM			UNIT	
			MIN	TYP	MAX	MIN	TYP	MAX		
SR	Slew rate at unity gain	$V_{O(PP)} = 0.8\text{ V}$, $C_L = 100\text{ pF}$, $R_L = 10\text{ k}\Omega$	25°C	5	9		5	9	V/ μs	
			Full range	4.7	6		4.7	6		
V_n	Equivalent input noise voltage	$f = 1\text{ kHz}$	25°C	21			21			nV/ $\sqrt{\text{Hz}}$
			$f = 10\text{ kHz}$	17			17			
$V_{N(PP)}$	Peak-to-peak equivalent input noise voltage	$f = 0.1\text{ Hz to }1\text{ Hz}$	25°C	0.33			0.33			μV
			$f = 0.1\text{ Hz to }10\text{ Hz}$	0.86			0.86			μV
I_n	Equivalent input noise current	$f = 100\text{ Hz}$	25°C	0.6			0.6			fA/ $\sqrt{\text{Hz}}$
THD + N	Total harmonic distortion plus noise	$R_L = 600\ \Omega$, $f = 1\text{ kHz}$	25°C	$A_V = 1$			0.0085%			
				$A_V = 10$			0.025%			
				$A_V = 100$			0.12%			
Gain-bandwidth product		$f = 10\text{ kHz}$, $C_L = 100\text{ pF}$	$R_L = 600\ \Omega$, 25°C	4.8			4.8			MHz
t_s	Settling time	$A_V = -1$, Step = 0.85 V to 1.85 V, $R_L = 600\ \Omega$, $C_L = 100\text{ pF}$	25°C	0.1%			0.186			μs
			25°C	0.01%			3.92			
ϕ_m	Phase margin at unity gain	$R_L = 600\ \Omega$, $C_L = 100\text{ pF}$	25°C	46°			46°			
	Gain margin		25°C	12			12			

† Full range is -40°C to 125°C for Q level part, -55°C to 125°C for M level part.

TLV277x, TLV277xA FAMILY OF 2.7-V HIGH-SLEW-RATE RAIL-TO-RAIL OUTPUT OPERATIONAL AMPLIFIERS WITH SHUTDOWN

SLOS296C JANUARY 1998 REVISED FEBRUARY 2004

查询 TLV277 系列器件

electrical characteristics at specified free-air temperature, $V_{DD} = 5\text{ V}$ (unless otherwise noted)

PARAMETER	TEST CONDITIONS	T_A †	TLV2772Q TLV2772M			TLV2772AQ TLV2772AM			UNIT
			MIN	TYP	MAX	MIN	TYP	MAX	
V_{IO} Input offset voltage	$V_{DD} = \pm 2.5\text{ V}$, $V_{IC} = 0$, $V_O = 0$, $R_S = 50\ \Omega$	25°C	0.36	2.5		0.36	1.6	mV	
		Full range	0.4	2.7		0.4	1.9		
$\alpha_{V_{IO}}$ Temperature coefficient of input offset voltage		25°C to 125°C	2			2			$\mu\text{V}/^\circ\text{C}$
I_{IO} Input offset current		25°C	1	60		1	60	pA	
		Full range	2	125		2	125		
I_{IB} Input bias current		25°C	2	60		2	60	pA	
	Full range	6	350		6	350			
V_{ICR} Common-mode input voltage range	CMRR > 60 dB, $R_S = 50\ \Omega$	25°C	0 to 3.7	-0.3 to 3.8		0 to 3.7	-0.3 to 3.8	V	
		Full range	0 to 3.7	-0.3 to 3.8		0 to 3.7	-0.3 to 3.8		
V_{OH} High-level output voltage	$I_{OH} = -1.3\text{ mA}$	25°C	4.9			4.9			V
		Full range	4.8			4.8			
	$I_{OH} = -4.2\text{ mA}$	25°C	4.7			4.7			
		Full range	4.4			4.4			
V_{OL} Low-level output voltage	$V_{IC} = 2.5\text{ V}$, $I_{OL} = 1.3\text{ mA}$	25°C	0.1			0.1			V
		Full range	0.2			0.2			
	$V_{IC} = 2.5\text{ V}$, $I_{OL} = 4.2\text{ mA}$	25°C	0.21			0.21			
		Full range	0.6			0.6			
A_{VD} Large-signal differential voltage amplification	$V_{IC} = 2.5\text{ V}$, $V_O = 1\text{ V to }4\text{ V}$	$R_L = 10\text{ k}\Omega, \ddagger$	25°C	20	450		20	450	V/mV
			Full range	13			13		
$r_{i(d)}$ Differential input resistance		25°C	10^{12}			10^{12}			Ω
$C_{i(c)}$ Common-mode input capacitance	$f = 10\text{ kHz}$,	25°C	8			8			pF
z_o Closed-loop output impedance	$f = 100\text{ kHz}$, $A_V = 10$	25°C	20			20			Ω
CMRR Common-mode rejection ratio	$V_{IC} = V_{ICR}(\text{min})$, $R_S = 50\ \Omega$	$V_O = 3.7\text{ V}$,	25°C	60	96		60	96	dB
			Full range	60	93		60	93	
k_{SVR} Supply voltage rejection ratio ($\Delta V_{DD} / \Delta V_{IO}$)	$V_{DD} = 2.7\text{ V to }5\text{ V}$, No load	$V_{IC} = V_{DD}/2$,	25°C	70	89		70	89	dB
			Full range	70	84		70	84	
I_{DD} Supply current (per channel)	$V_O = 1.5\text{ V}$, No load	25°C	1	2		1	2	mA	
		Full range		2			2		

† Full range is -40°C to 125°C for Q level part, -55°C to 125°C for M level part.

‡ Referenced to 2.5 V

TLV277x, TLV277xA
FAMILY OF 2.7-V HIGH-SLEW-RATE RAIL-TO-RAIL OUTPUT
OPERATIONAL AMPLIFIERS WITH SHUTDOWN

SLOS209G – JANUARY 1998 – REVISED FEBRUARY 2004

[查询"TLV2772"供应商](#)

operating characteristics at specified free-air temperature, $V_{DD} = 5\text{ V}$ (unless otherwise noted)

PARAMETER	TEST CONDITIONS	T_A^\dagger	TLV2772Q TLV2772M			TLV2772AQ TLV2772AM			UNIT	
			MIN	TYP	MAX	MIN	TYP	MAX		
SR	Slew rate at unity gain	$V_{O(PP)} = 1.5\text{ V}$, $C_L = 100\text{ pF}$, $R_L = 10\text{ k}\Omega$	25°C	5	10.5		5	10.5	V/ μs	
			Full range	4.7	6		4.7	6		
V_n	Equivalent input noise voltage	$f = 1\text{ kHz}$	25°C	17			17			nV/ $\sqrt{\text{Hz}}$
			$f = 10\text{ kHz}$	12			12			
$V_{N(PP)}$	Peak-to-peak equivalent input noise voltage	$f = 0.1\text{ Hz to }1\text{ Hz}$	25°C	0.33			0.33			μV
			$f = 0.1\text{ Hz to }10\text{ Hz}$	0.86			0.86			μV
I_n	Equivalent input noise current	$f = 100\text{ Hz}$	25°C	0.6			0.6			fA/ $\sqrt{\text{Hz}}$
THD + N	Total harmonic distortion plus noise	$R_L = 600\ \Omega$, $f = 1\text{ kHz}$	25°C	$A_V = 1$			0.005%			
				$A_V = 10$			0.016%			
				$A_V = 100$			0.095%			
Gain-bandwidth product		$f = 10\text{ kHz}$, $C_L = 100\text{ pF}$	$R_L = 600\ \Omega$, 25°C	5.1			5.1			MHz
t_s	Settling time	$A_V = -1$, Step = 1.5 V to 3.5 V, $R_L = 600\ \Omega$, $C_L = 100\text{ pF}$	25°C	0.134			0.134			μs
			25°C	1.97			1.97			
ϕ_m	Phase margin at unity gain	$R_L = 600\ \Omega$, $C_L = 100\text{ pF}$	25°C	46°			46°			
	Gain margin		25°C	12			12			

† Full range is -40°C to 125°C for Q level part, -55°C to 125°C for M level part.

TLV277x, TLV277xA
FAMILY OF 2.7-V HIGH-SLEW-RATE RAIL-TO-RAIL OUTPUT
OPERATIONAL AMPLIFIERS WITH SHUTDOWN

SLOS096 "JANUARY 1998 REVISED FEBRUARY 2004" 查閱 TLV2772 中文說明

TYPICAL CHARACTERISTICS

Table of Graphs

			FIGURE
V_{IO}	Input offset voltage	Distribution	1,2
		vs Common-mode input voltage	3,4
		Distribution	5,6
I_{IB}/I_{IO}	Input bias and input offset currents	vs Free-air temperature	7
V_{OH}	High-level output voltage	vs High-level output current	8,9
V_{OL}	Low-level output voltage	vs Low-level output current	10,11
$V_{O(PP)}$	Maximum peak-to-peak output voltage	vs Frequency	12,13
I_{OS}	Short-circuit output current	vs Supply voltage	14
		vs Free-air temperature	15
V_O	Output voltage	vs Differential input voltage	16
A_{VD}	Large-signal differential voltage amplification and phase margin	vs Frequency	17,18
A_{VD}	Differential voltage amplification	vs Load resistance	19
		vs Free-air temperature	20,21
z_o	Output impedance	vs Frequency	22,23
CMRR	Common-mode rejection ratio	vs Frequency	24
		vs Free-air temperature	25
k_{SVR}	Supply-voltage rejection ratio	vs Frequency	26,27
I_{DD}	Supply current (per channel)	vs Supply voltage	28
SR	Slew rate	vs Load capacitance	29
		vs Free-air temperature	30
V_O	Voltage-follower small-signal pulse response		31,32
V_O	Voltage-follower large-signal pulse response		33,34
V_O	Inverting small-signal pulse response		35,36
V_O	Inverting large-signal pulse response		37,38
V_n	Equivalent input noise voltage	vs Frequency	39,40
		Noise voltage (referred to input)	Over a 10-second period
THD + N	Total harmonic distortion plus noise	vs Frequency	42,43
		Gain-bandwidth product	vs Supply voltage
B_1	Unity-gain bandwidth	vs Load capacitance	45
ϕ_m	Phase margin	vs Load capacitance	46
		Gain margin	vs Load capacitance
	Amplifier with shutdown pulse turnon/off characteristics		48 – 50
	Supply current with shutdown pulse turnon/off characteristics		51 – 53
	Shutdown supply current	vs Free-air temperature	54
	Shutdown forward/reverse isolation	vs Frequency	55, 56

TYPICAL CHARACTERISTICS

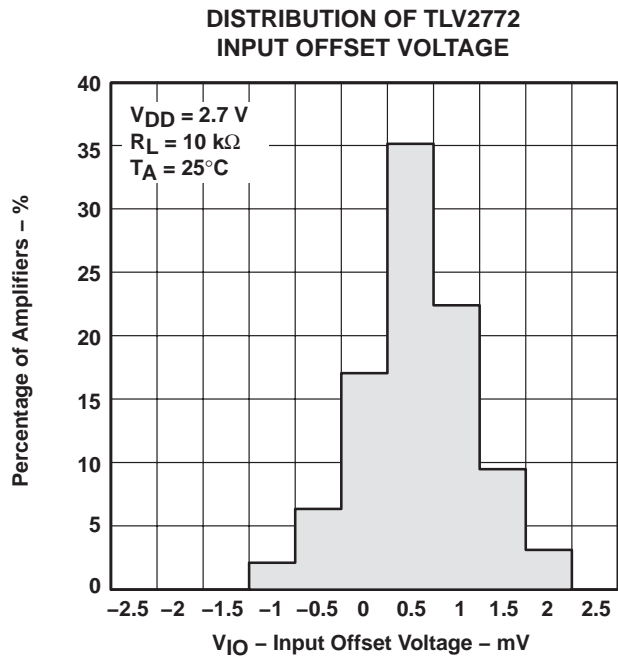

Figure 1

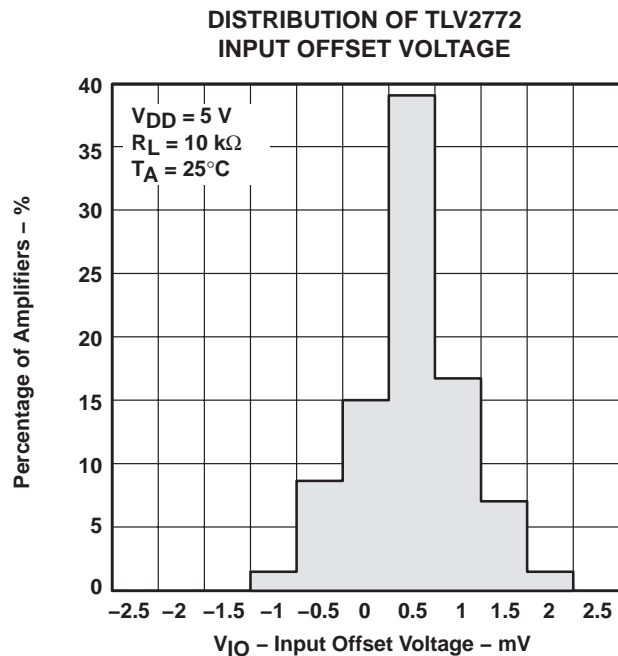

Figure 2

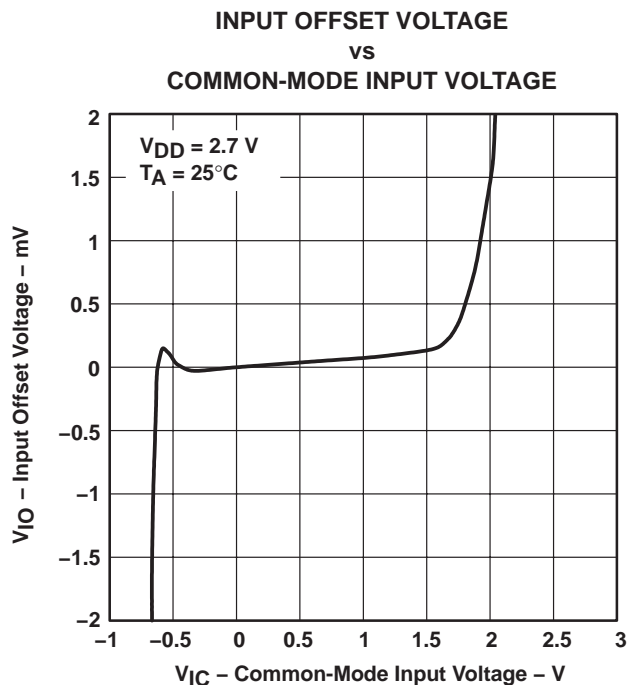

Figure 3

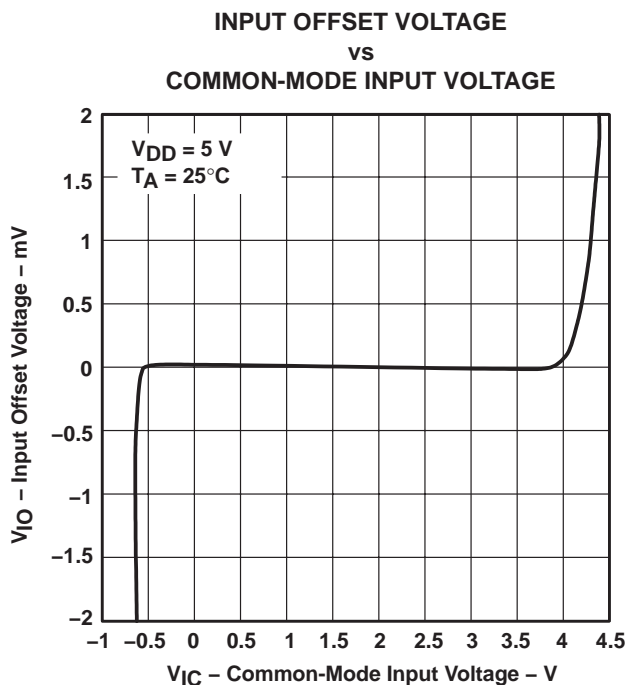

Figure 4

TLV277x, TLV277xA
FAMILY OF 2.7-V HIGH-SLEW-RATE RAIL-TO-RAIL OUTPUT
OPERATIONAL AMPLIFIERS WITH SHUTDOWN

SLOS099C JANUARY 1998 REVISED FEBRUARY 2004
 查询 TLV2772 样品

TYPICAL CHARACTERISTICS

DISTRIBUTION OF TLV2772
INPUT OFFSET VOLTAGE

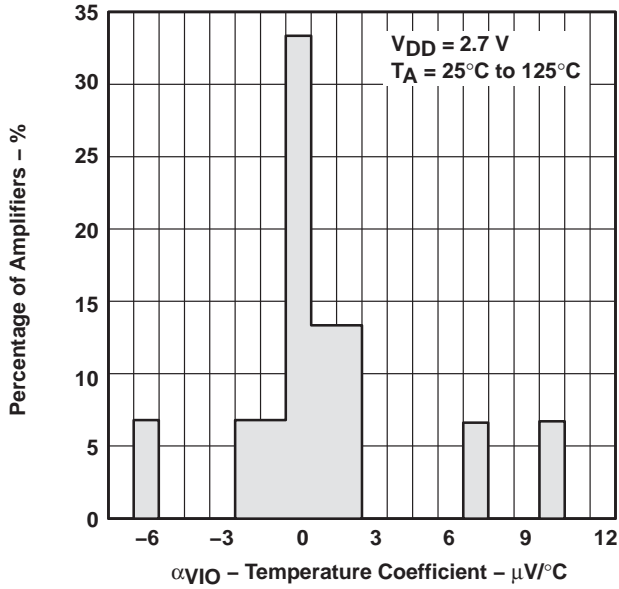

Figure 5

DISTRIBUTION OF TLV2772
INPUT OFFSET VOLTAGE

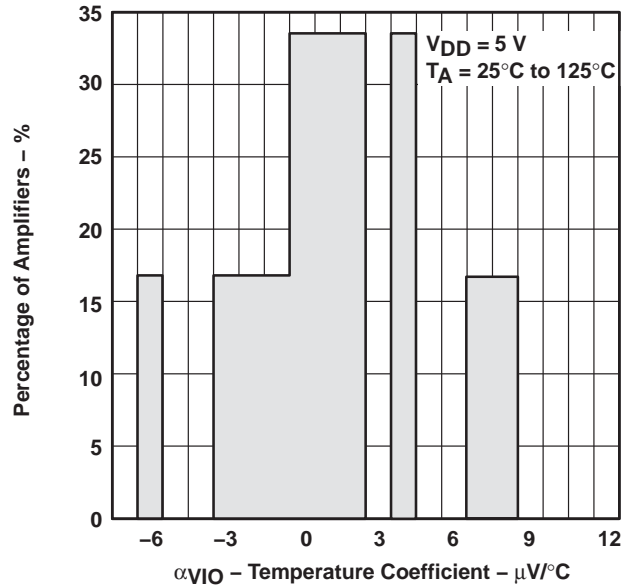

Figure 6

INPUT BIAS AND OFFSET CURRENT
vs
FREE-AIR TEMPERATURE

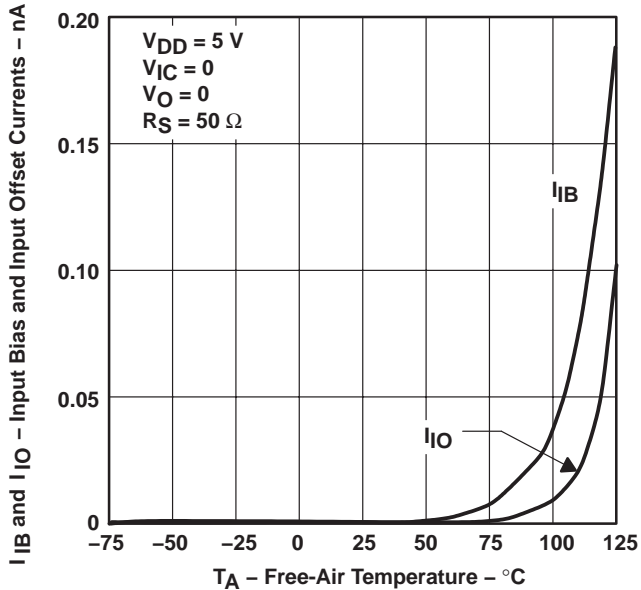

Figure 7

HIGH-LEVEL OUTPUT VOLTAGE
vs
HIGH-LEVEL OUTPUT CURRENT

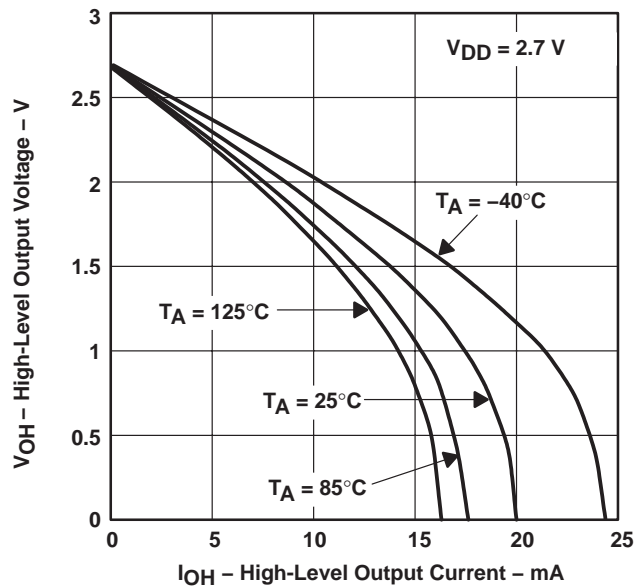

Figure 8

TLV277x, TLV277xA

FAMILY OF 2.7-V HIGH-SLEW-RATE RAIL-TO-RAIL OUTPUT OPERATIONAL AMPLIFIERS WITH SHUTDOWN

SLOS209G – JANUARY 1998 – REVISED FEBRUARY 2004

[查询"TLV2772"供应商](#)

TYPICAL CHARACTERISTICS

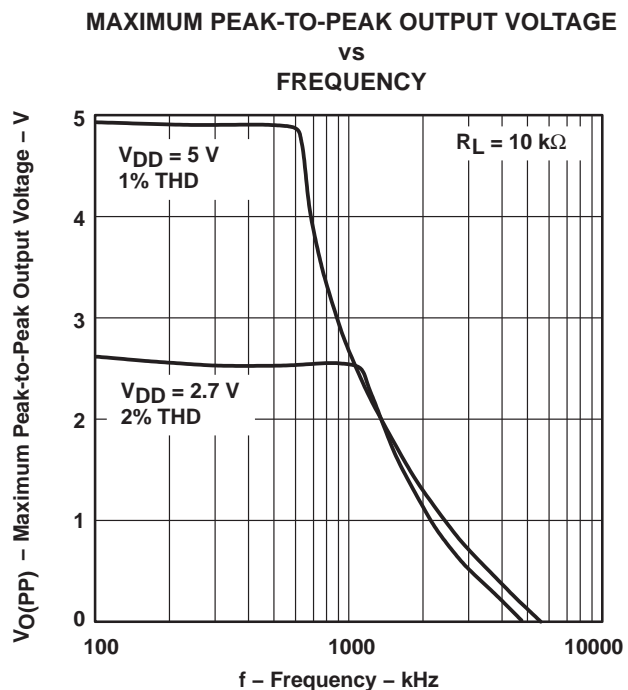
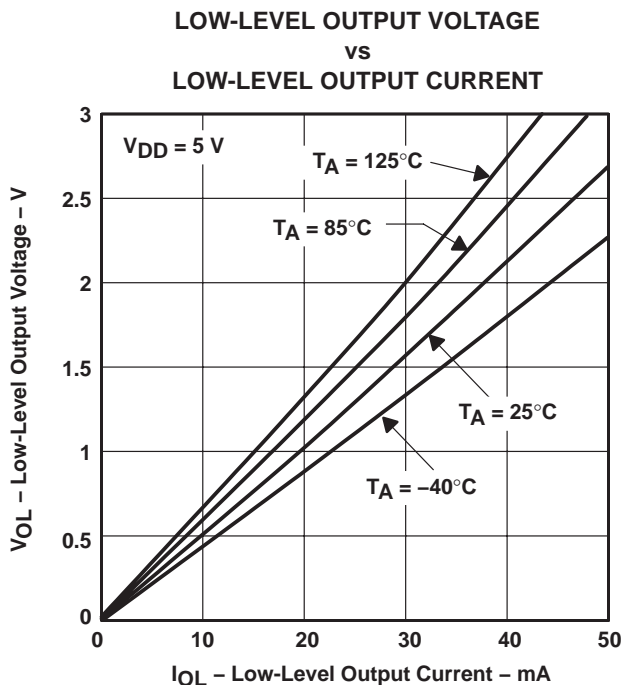
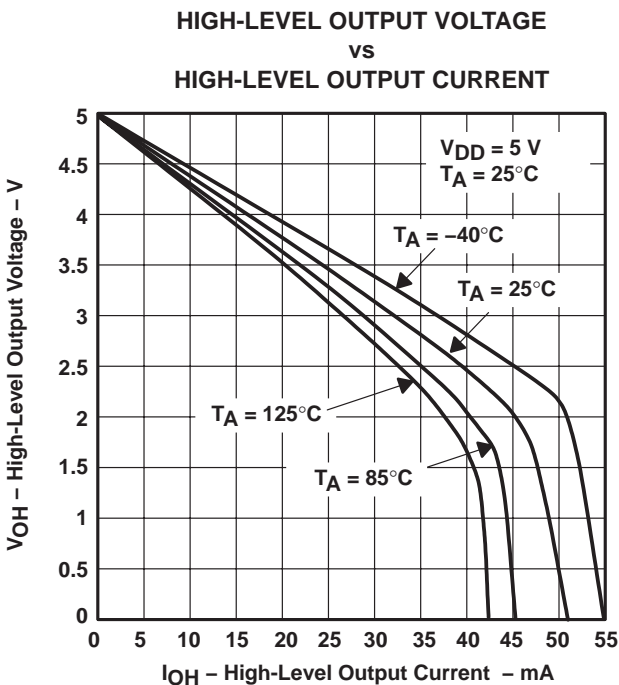

TLV277x, TLV277xA

FAMILY OF 2.7-V HIGH-SLEW-RATE RAIL-TO-RAIL OUTPUT OPERATIONAL AMPLIFIERS WITH SHUTDOWN

SLOA096 JANUARY 1998 REVISED FEBRUARY 2004

查询 TLV277 系列器件

TYPICAL CHARACTERISTICS

MAXIMUM PEAK-TO-PEAK OUTPUT VOLTAGE
vs
FREQUENCY

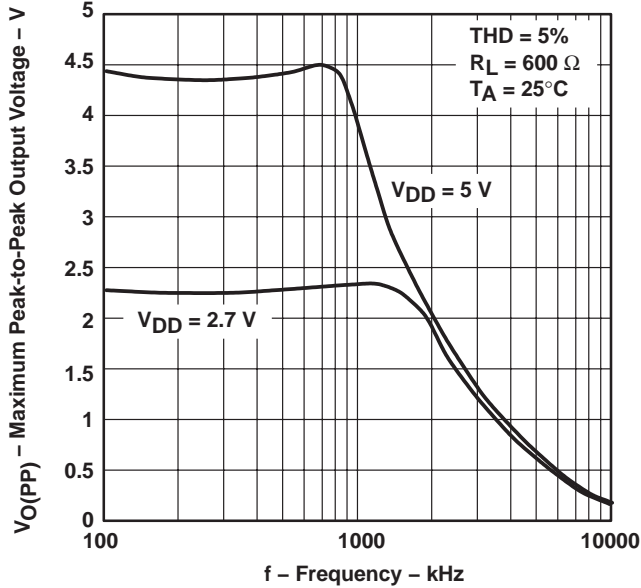

Figure 13

SHORT-CIRCUIT OUTPUT CURRENT
vs
SUPPLY VOLTAGE

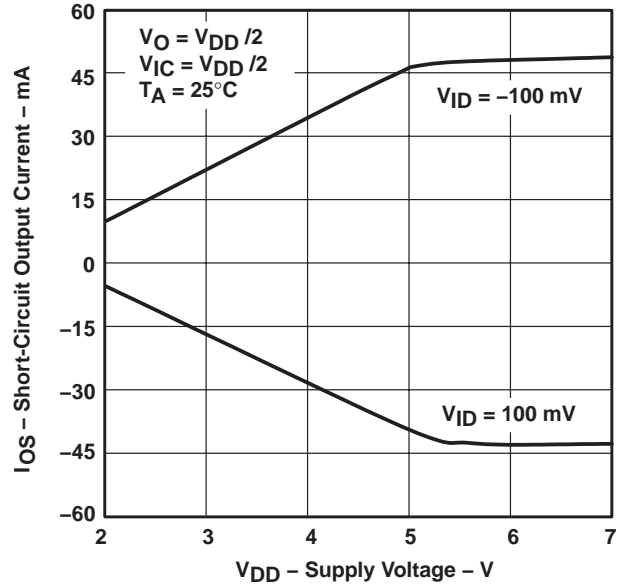

Figure 14

SHORT-CIRCUIT OUTPUT CURRENT
vs
FREE-AIR TEMPERATURE

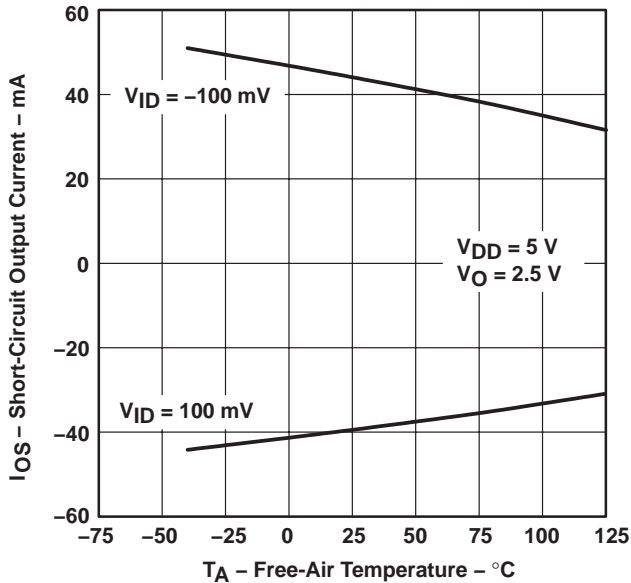

Figure 15

OUTPUT VOLTAGE
vs
DIFFERENTIAL INPUT VOLTAGE

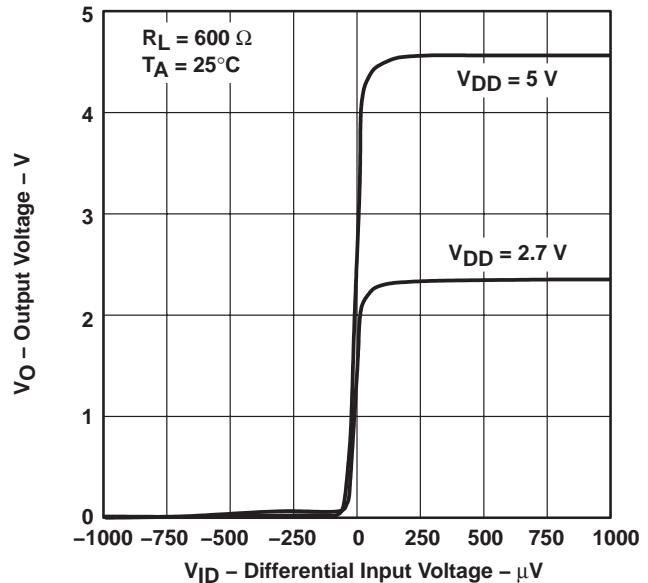

Figure 16

TLV277x, TLV277xA
FAMILY OF 2.7-V HIGH-SLEW-RATE RAIL-TO-RAIL OUTPUT
OPERATIONAL AMPLIFIERS WITH SHUTDOWN

SLOS209G – JANUARY 1998 – REVISED FEBRUARY 2004

[查询"TLV2772"供应商](#)

TYPICAL CHARACTERISTICS

**LARGE-SIGNAL DIFFERENTIAL VOLTAGE AMPLIFICATION
AND PHASE MARGIN
VS
FREQUENCY**

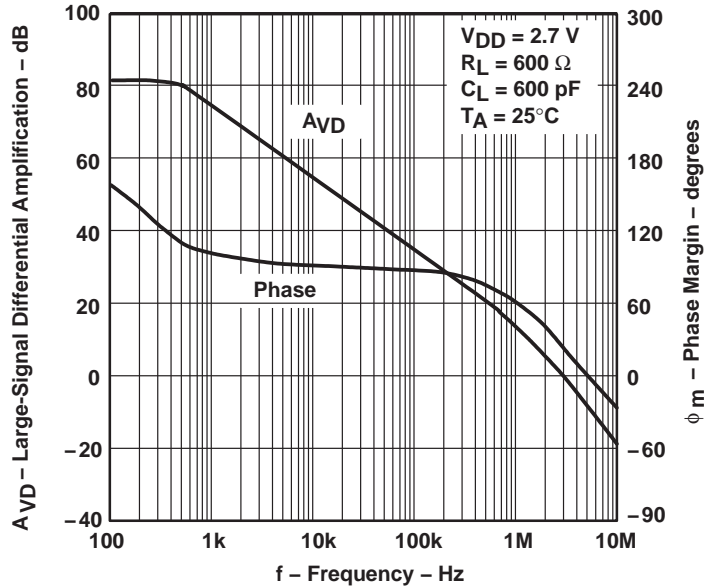

Figure 17

**LARGE-SIGNAL DIFFERENTIAL VOLTAGE AMPLIFICATION
AND PHASE MARGIN
VS
FREQUENCY**

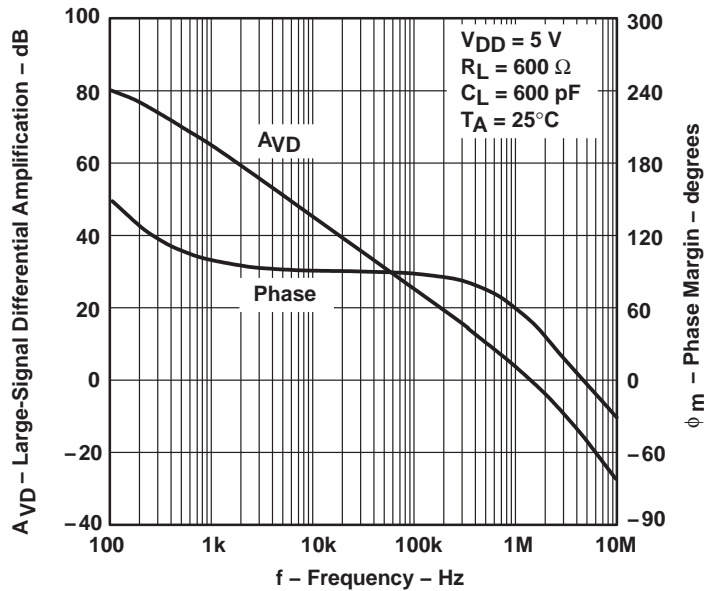

Figure 18

TLV277x, TLV277xA
FAMILY OF 2.7-V HIGH-SLEW-RATE RAIL-TO-RAIL OUTPUT
OPERATIONAL AMPLIFIERS WITH SHUTDOWN

SLOS0961 JANUARY 1998 REVISED FEBRUARY 2004

查询 TLV277 代理商

TYPICAL CHARACTERISTICS

DIFFERENTIAL VOLTAGE AMPLIFICATION
vs
LOAD RESISTANCE

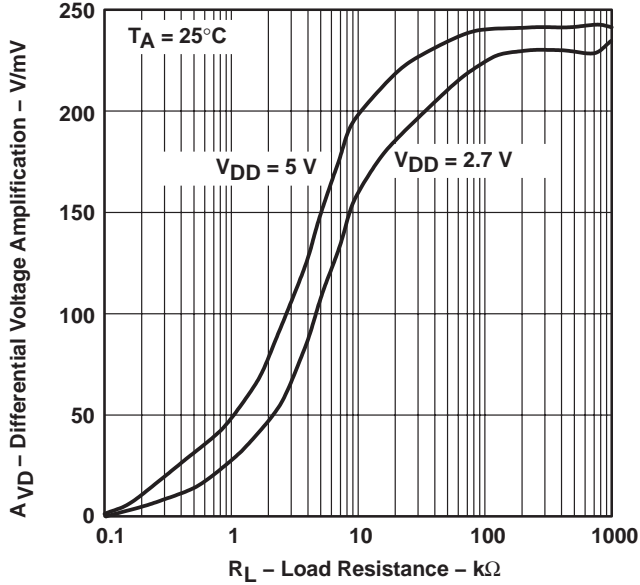

Figure 19

DIFFERENTIAL VOLTAGE AMPLIFICATION
vs
FREE-AIR TEMPERATURE

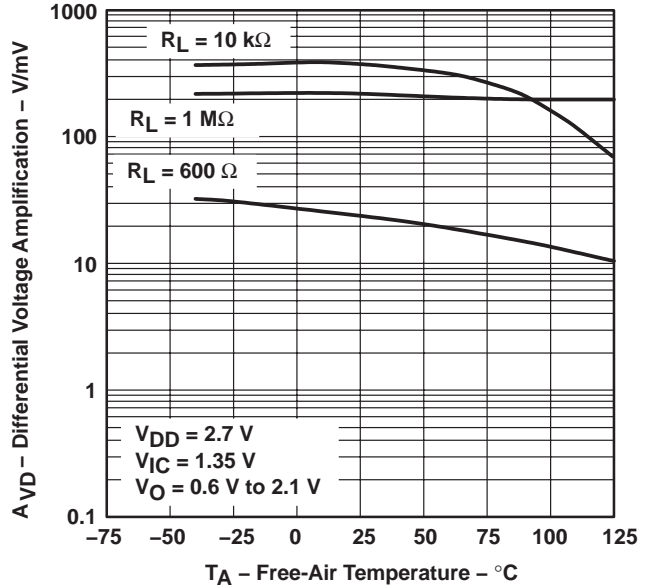

Figure 20

DIFFERENTIAL VOLTAGE AMPLIFICATION
vs
FREE-AIR TEMPERATURE

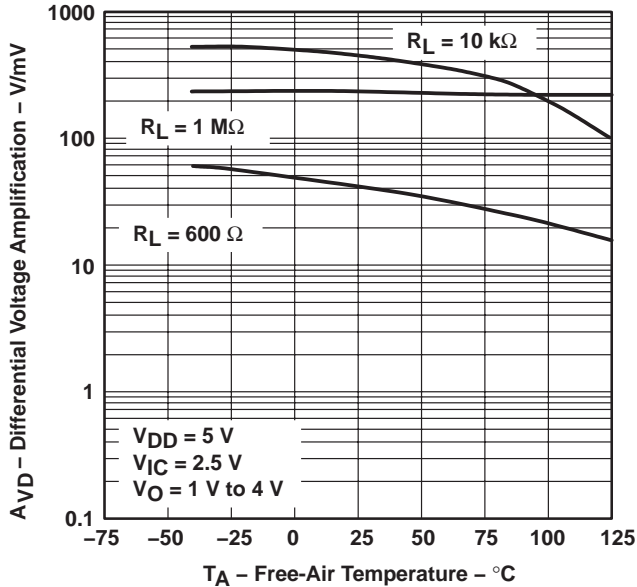

Figure 21

OUTPUT IMPEDANCE
vs
FREQUENCY

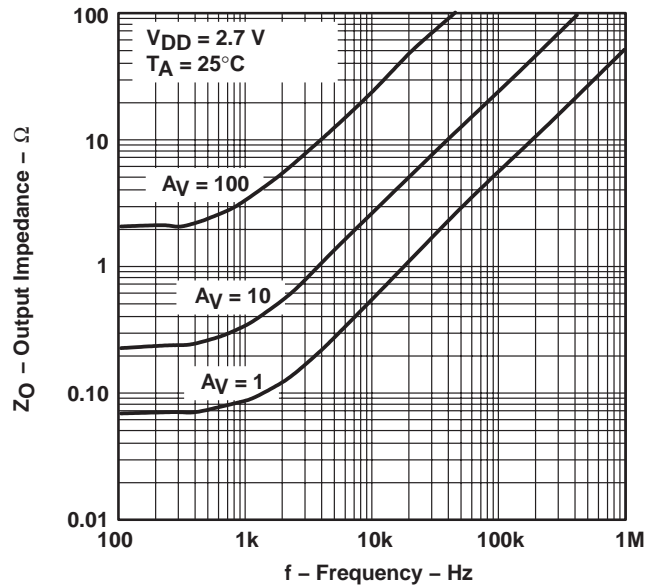

Figure 22

TLV277x, TLV277xA
FAMILY OF 2.7-V HIGH-SLEW-RATE RAIL-TO-RAIL OUTPUT
OPERATIONAL AMPLIFIERS WITH SHUTDOWN

SLOS209G – JANUARY 1998 – REVISED FEBRUARY 2004

[查询"TLV2772"供应商](#)

TYPICAL CHARACTERISTICS

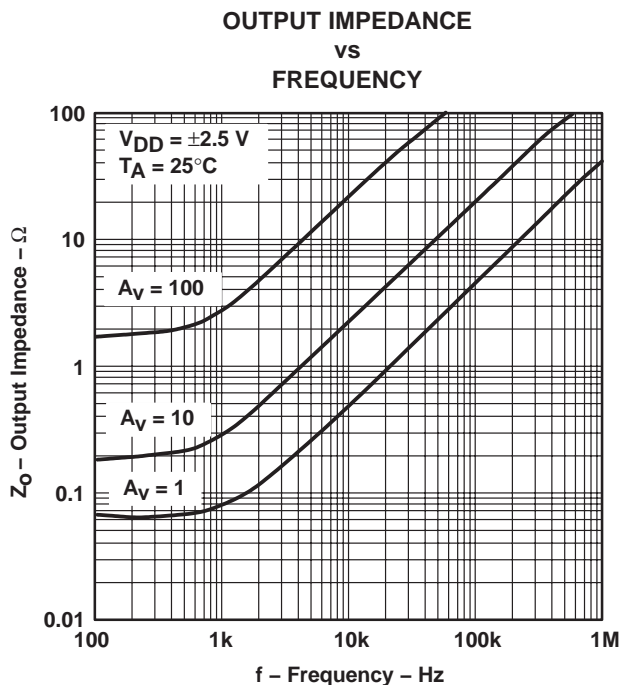

Figure 23

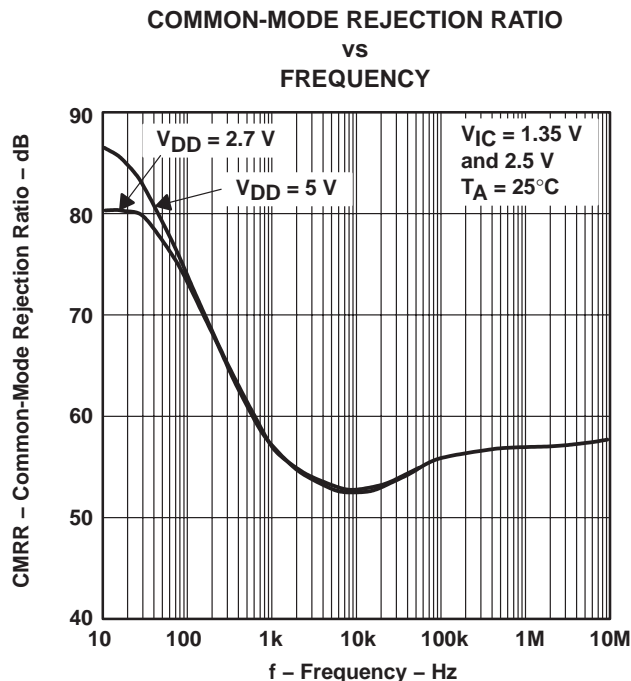

Figure 24

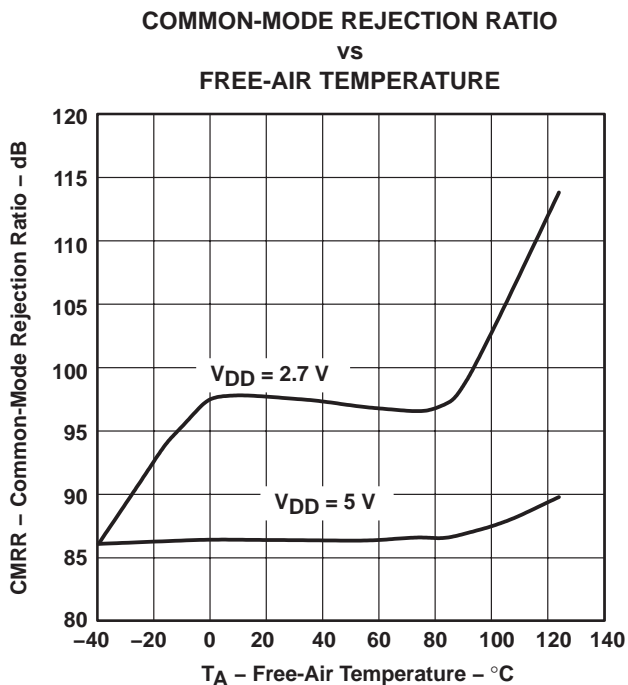

Figure 25

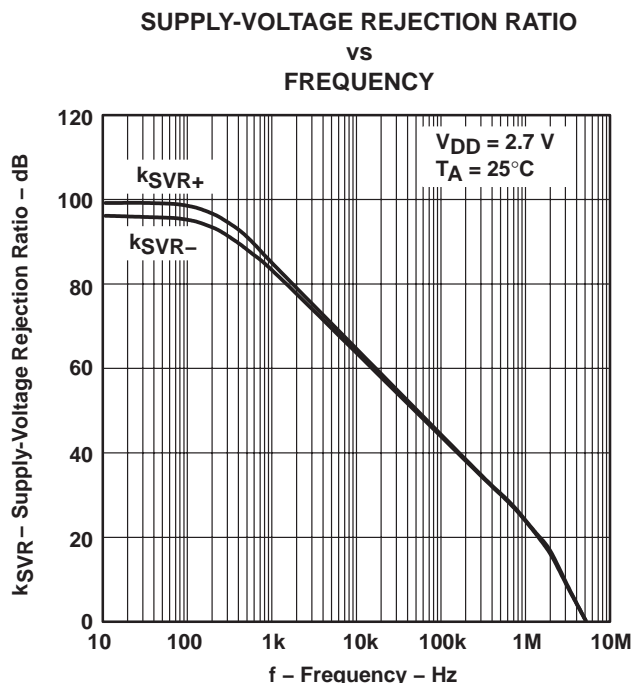

Figure 26

TLV277x, TLV277xA FAMILY OF 2.7-V HIGH-SLEW-RATE RAIL-TO-RAIL OUTPUT OPERATIONAL AMPLIFIERS WITH SHUTDOWN

SLOS096 JANUARY 1998 REVISED FEBRUARY 2004
查看 TLV277 的应用

TYPICAL CHARACTERISTICS

SUPPLY VOLTAGE REJECTION RATIO
vs
FREQUENCY

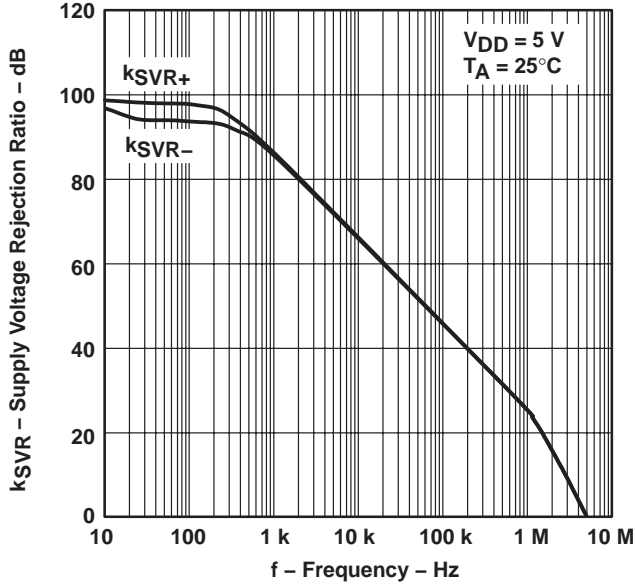

Figure 27

SUPPLY CURRENT (PER CHANNEL)
vs
SUPPLY VOLTAGE

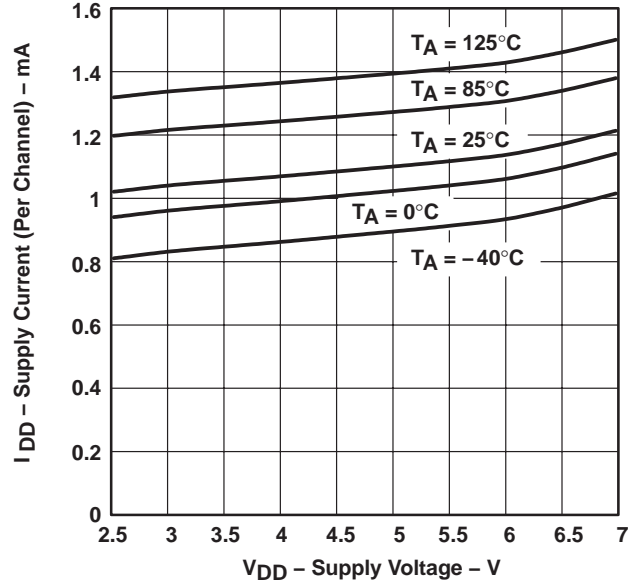

Figure 28

SLEW RATE
vs
LOAD CAPACITANCE

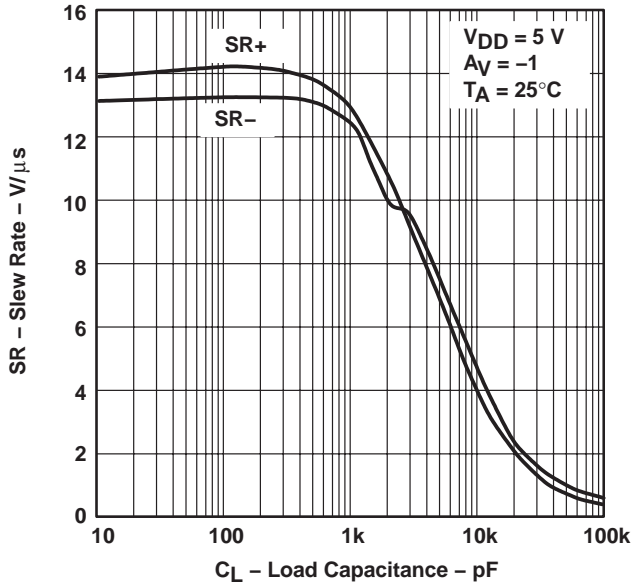

Figure 29

SLEW RATE
vs
FREE-AIR TEMPERATURE

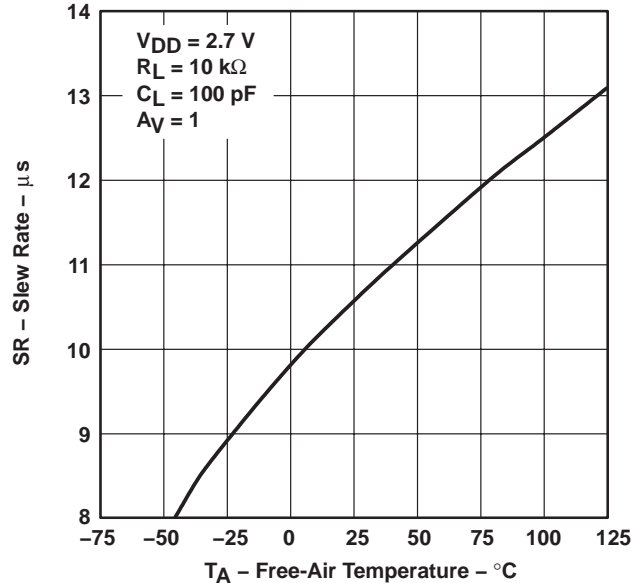
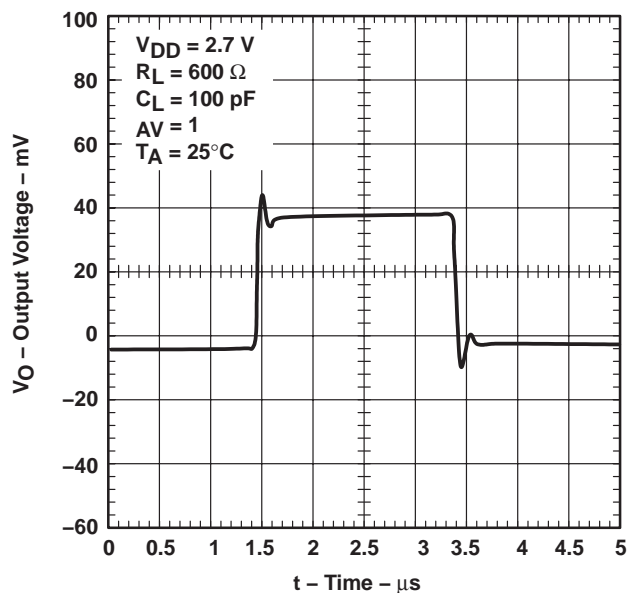

Figure 30

TYPICAL CHARACTERISTICS

**VOLTAGE-FOLLOWER
SMALL-SIGNAL PULSE RESPONSE**



**VOLTAGE-FOLLOWER
SMALL-SIGNAL PULSE RESPONSE**

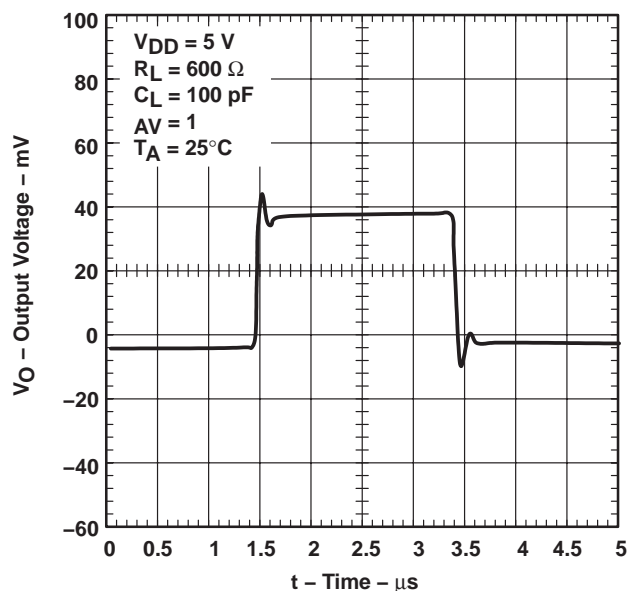

**VOLTAGE-FOLLOWER
LARGE-SIGNAL PULSE RESPONSE**

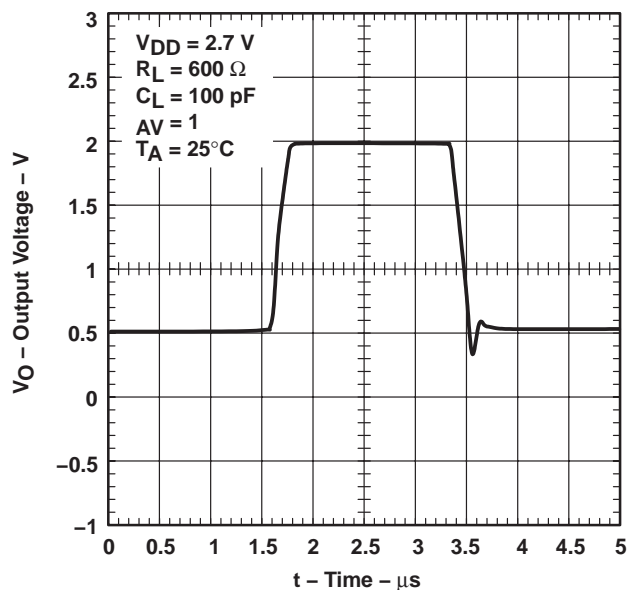

**VOLTAGE-FOLLOWER
LARGE-SIGNAL PULSE RESPONSE**

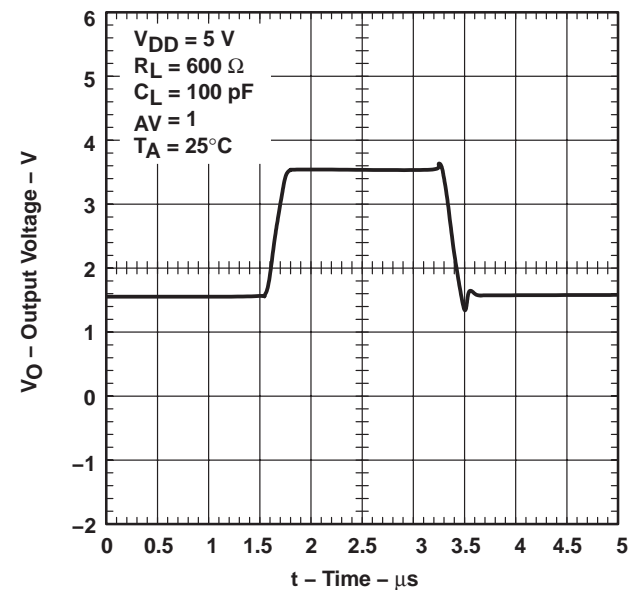

TLV277x, TLV277xA FAMILY OF 2.7-V HIGH-SLEW-RATE RAIL-TO-RAIL OUTPUT OPERATIONAL AMPLIFIERS WITH SHUTDOWN

SLOS096C JANUARY 1998 REVISION D FEBRUARY 2004

查询TLV2772 请应用

TYPICAL CHARACTERISTICS

**INVERTING SMALL-SIGNAL
PULSE RESPONSE**

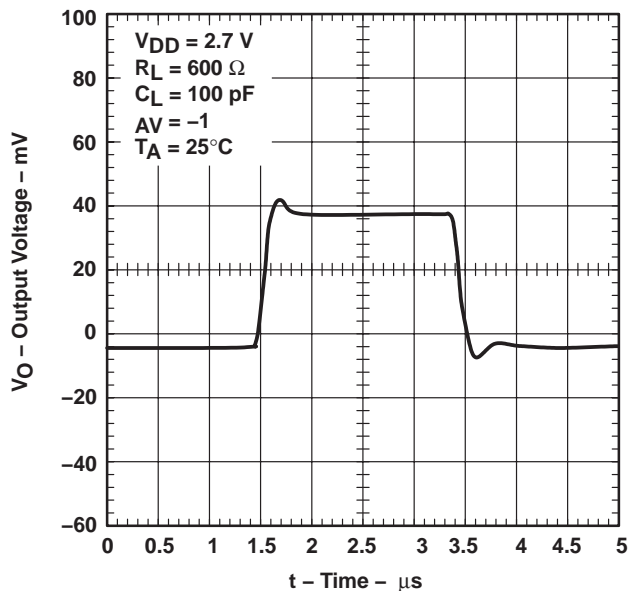

Figure 35

**INVERTING SMALL-SIGNAL
PULSE RESPONSE**

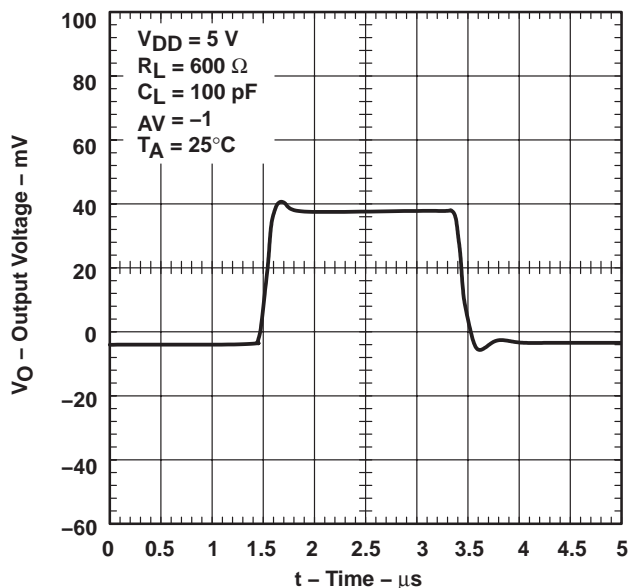

Figure 36

**INVERTING LARGE-SIGNAL
PULSE RESPONSE**

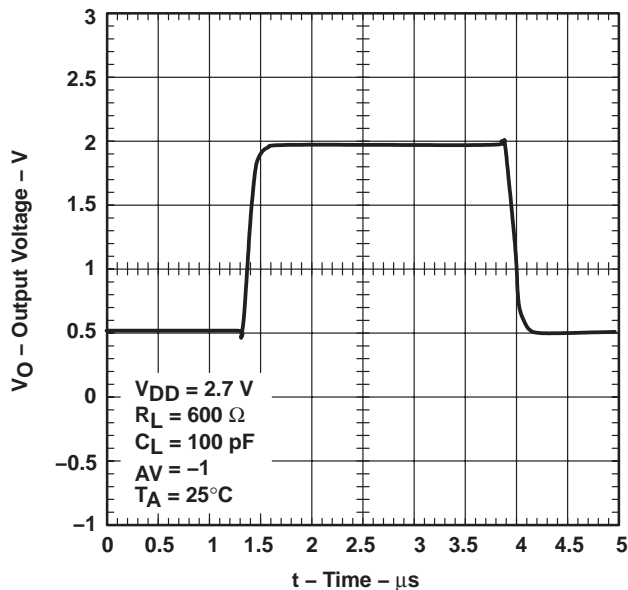

Figure 37

**INVERTING LARGE-SIGNAL
PULSE RESPONSE**

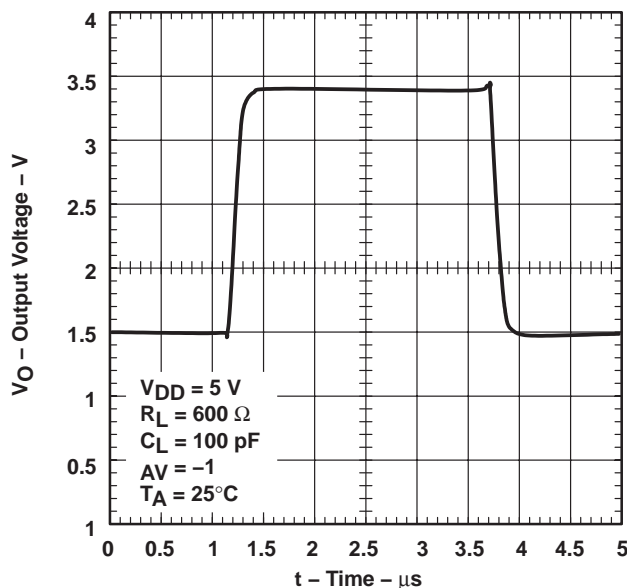

Figure 38

TYPICAL CHARACTERISTICS

EQUIVALENT INPUT NOISE VOLTAGE
 vs
 FREQUENCY

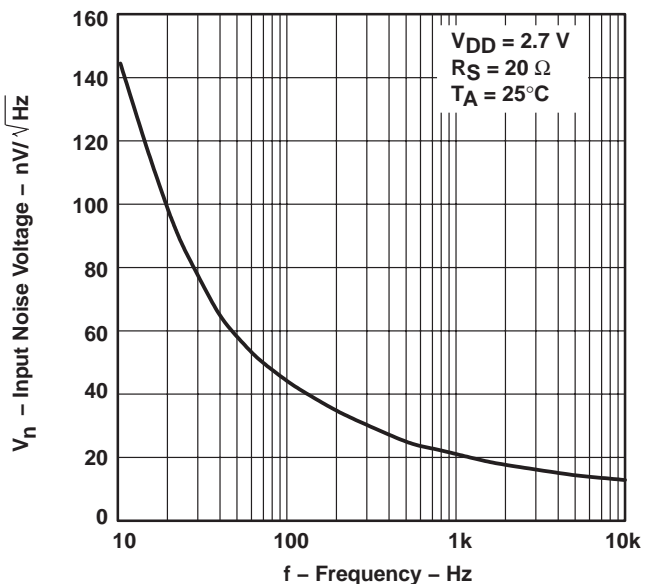

Figure 39

EQUIVALENT INPUT NOISE VOLTAGE
 vs
 FREQUENCY

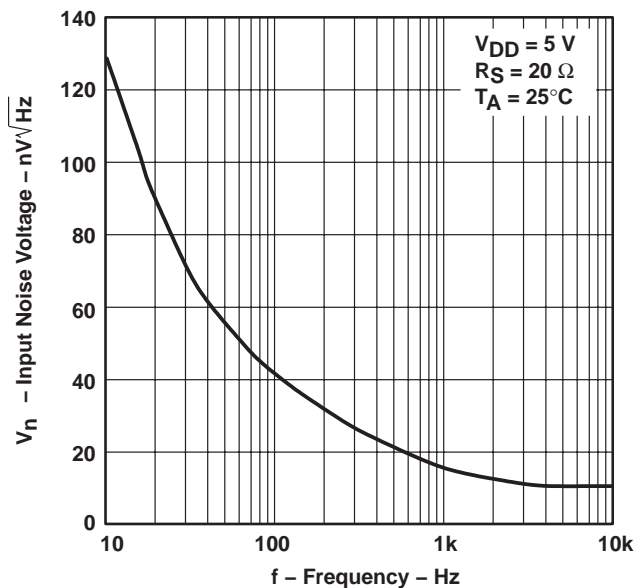

Figure 40

NOISE VOLTAGE
 OVER A 10 SECOND PERIOD

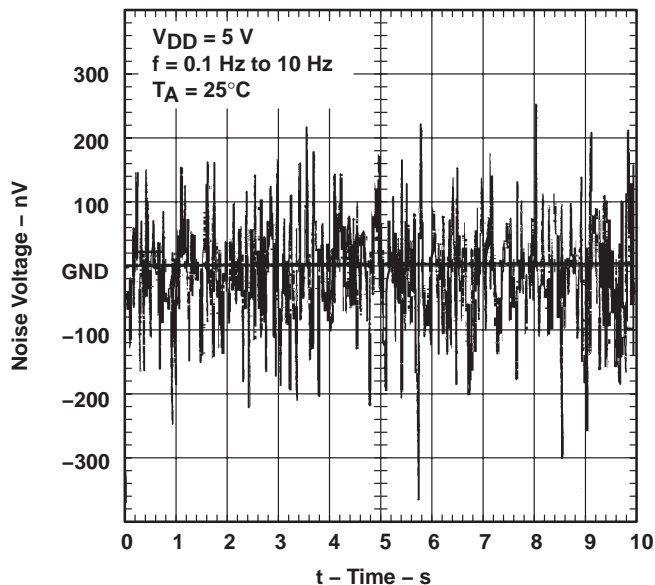

Figure 41

TLV277x, TLV277xA
FAMILY OF 2.7-V HIGH-SLEW-RATE RAIL-TO-RAIL OUTPUT
OPERATIONAL AMPLIFIERS WITH SHUTDOWN

SLOS096C JANUARY 1998 REVISION D FEBRUARY 2004

TYPICAL CHARACTERISTICS

TOTAL HARMONIC DISTORTION PLUS NOISE
vs
FREQUENCY

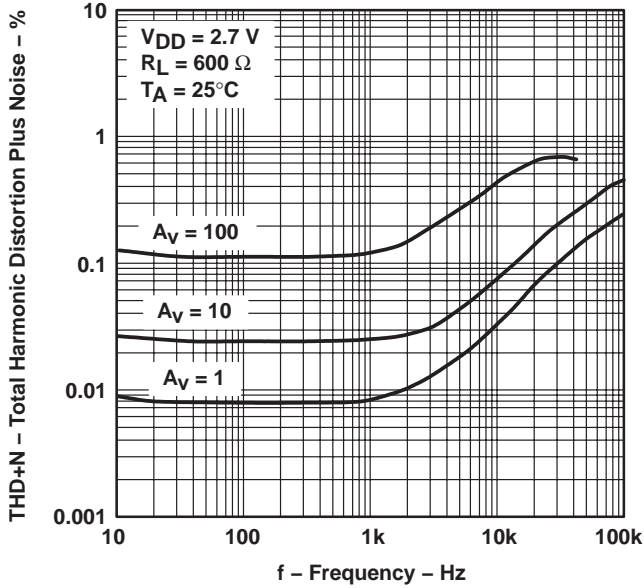

Figure 42

TOTAL HARMONIC DISTORTION PLUS NOISE
vs
FREQUENCY

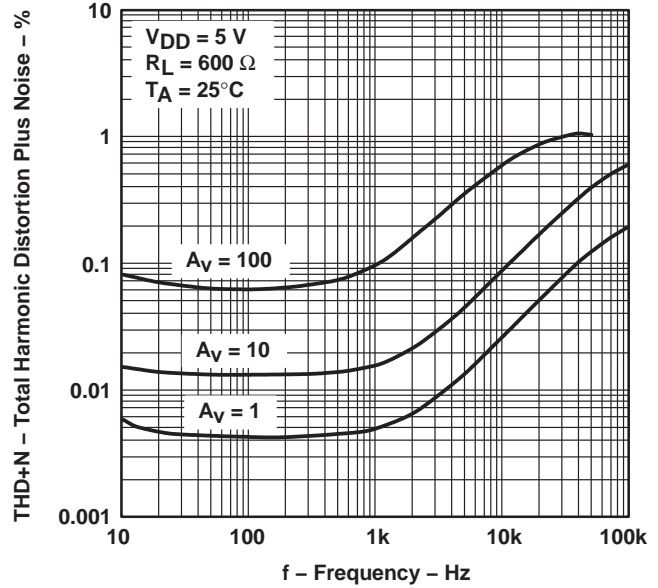

Figure 43

GAIN-BANDWIDTH PRODUCT
vs
SUPPLY VOLTAGE

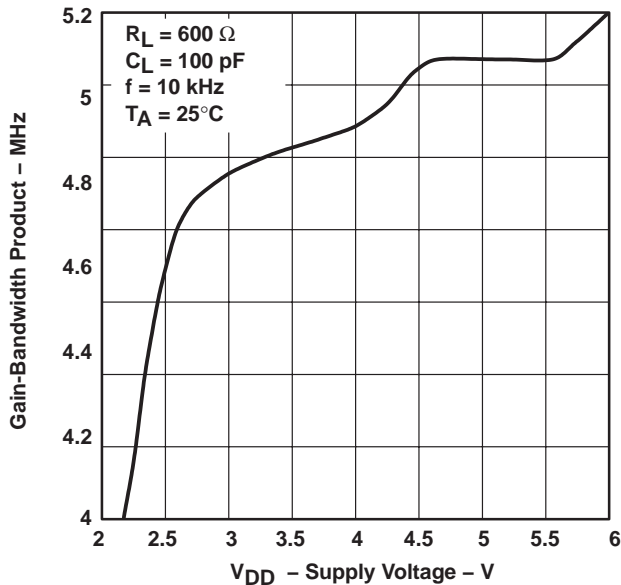

Figure 44

UNITY-GAIN BANDWIDTH
vs
LOAD CAPACITANCE

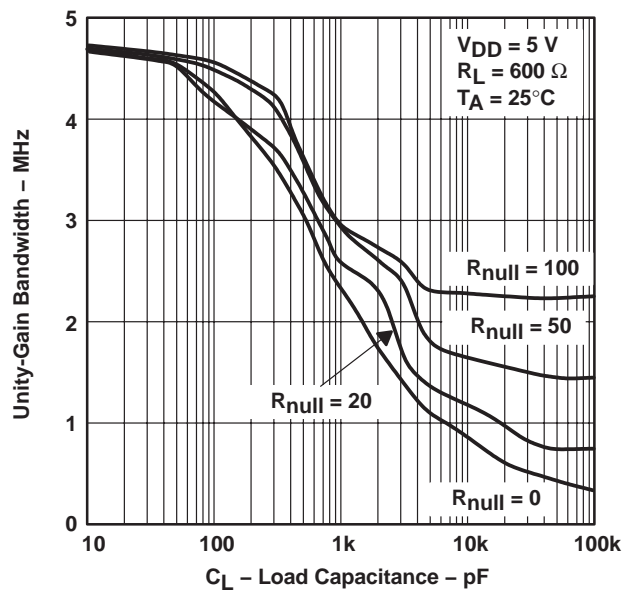

Figure 45

TLV277x, TLV277xA

FAMILY OF 2.7-V HIGH-SLEW-RATE RAIL-TO-RAIL OUTPUT OPERATIONAL AMPLIFIERS WITH SHUTDOWN

SLOS209G – JANUARY 1998 – REVISED FEBRUARY 2004

[查询"TLV2772"供应商](#)

TYPICAL CHARACTERISTICS

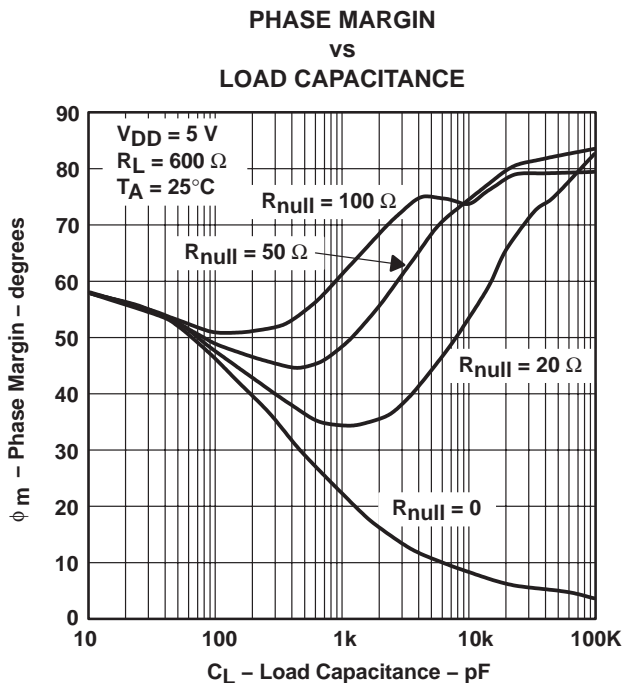

Figure 46

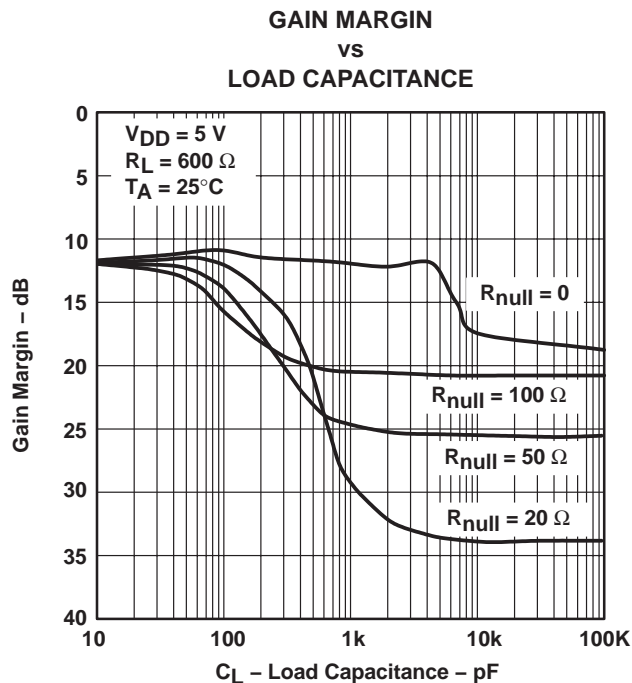

Figure 47

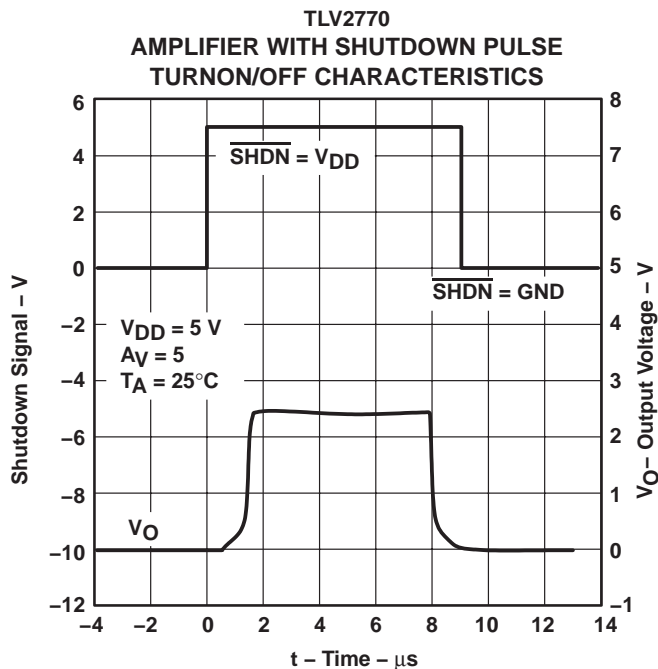

Figure 48

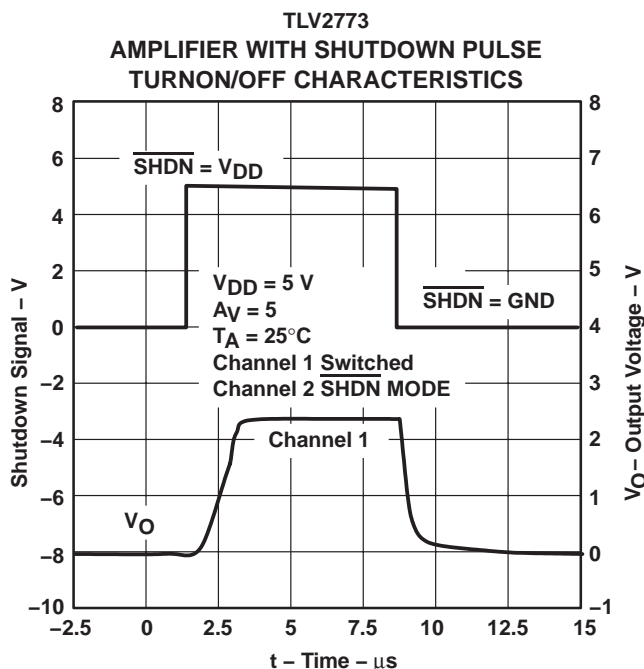

Figure 49

TLV277x, TLV277xA FAMILY OF 2.7-V HIGH-SLEW-RATE RAIL-TO-RAIL OUTPUT OPERATIONAL AMPLIFIERS WITH SHUTDOWN

SLOS096 "JANUARY 1998 REVISION D FEBRUARY 2004
查看 TLV2772 供应链

TYPICAL CHARACTERISTICS

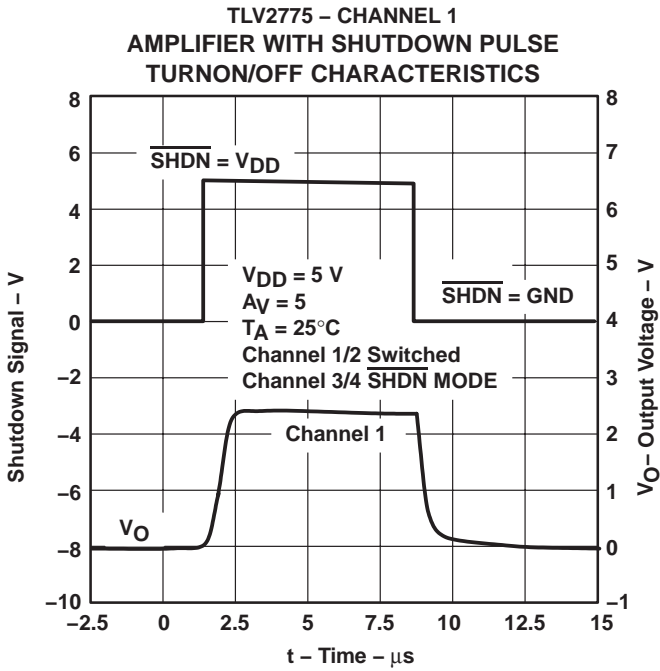

Figure 50

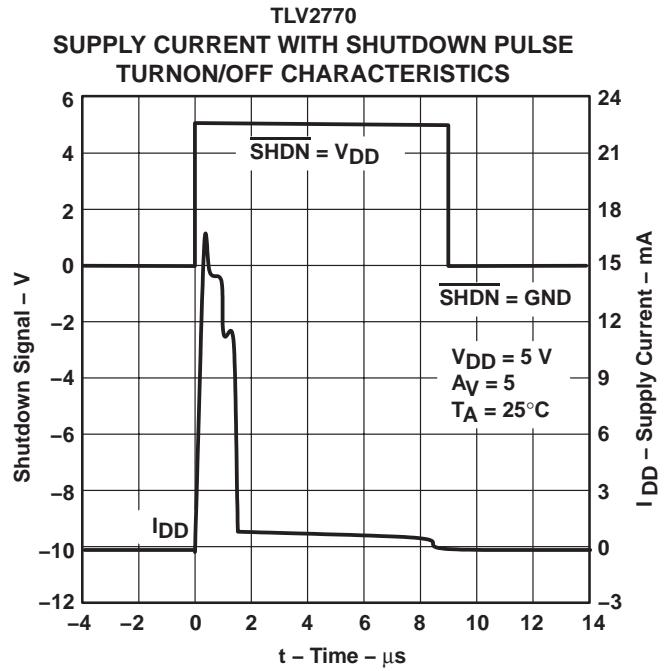

Figure 51

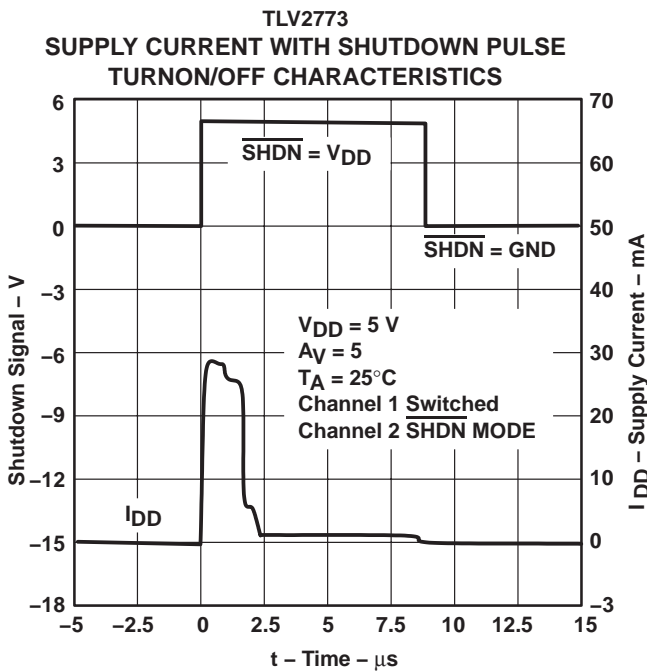

Figure 52

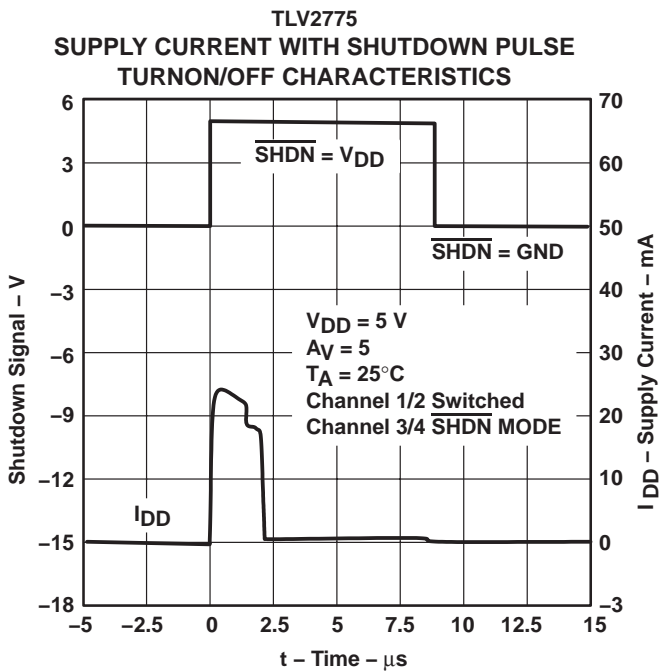

Figure 53

TLV277x, TLV277xA
FAMILY OF 2.7-V HIGH-SLEW-RATE RAIL-TO-RAIL OUTPUT
OPERATIONAL AMPLIFIERS WITH SHUTDOWN

SLOS209G – JANUARY 1998 – REVISED FEBRUARY 2004

[查询"TLV2772"供应商](#)

TYPICAL CHARACTERISTICS

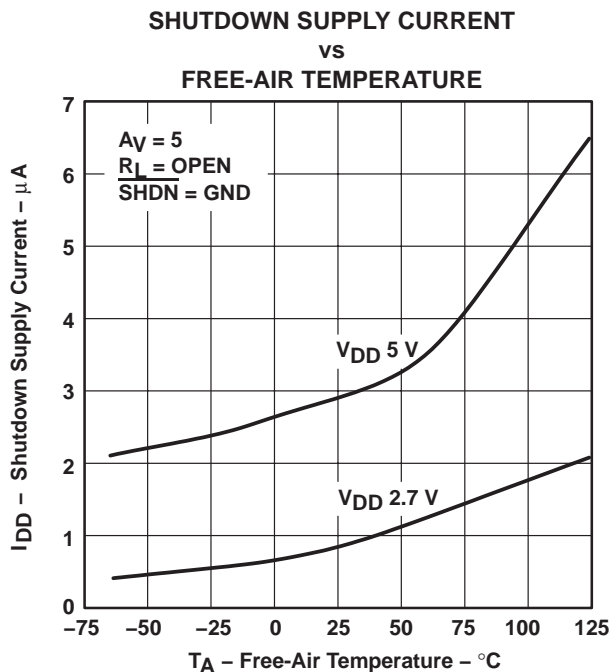

Figure 54

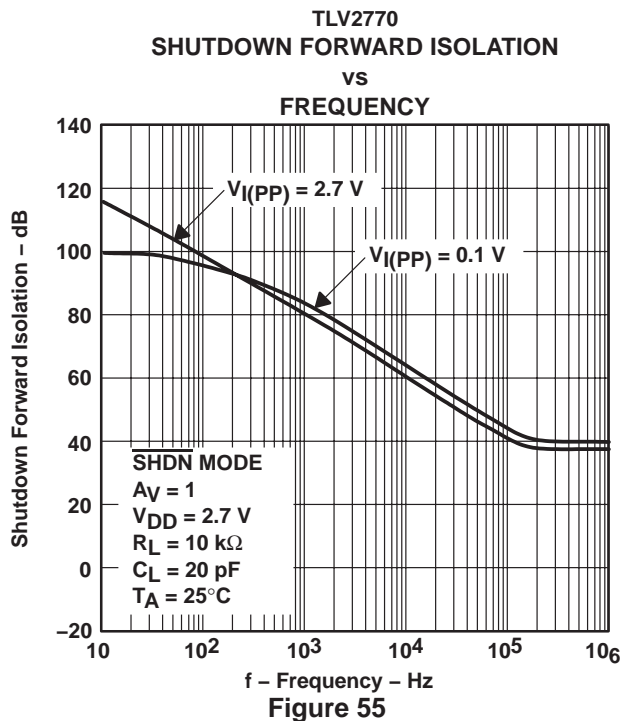

Figure 55

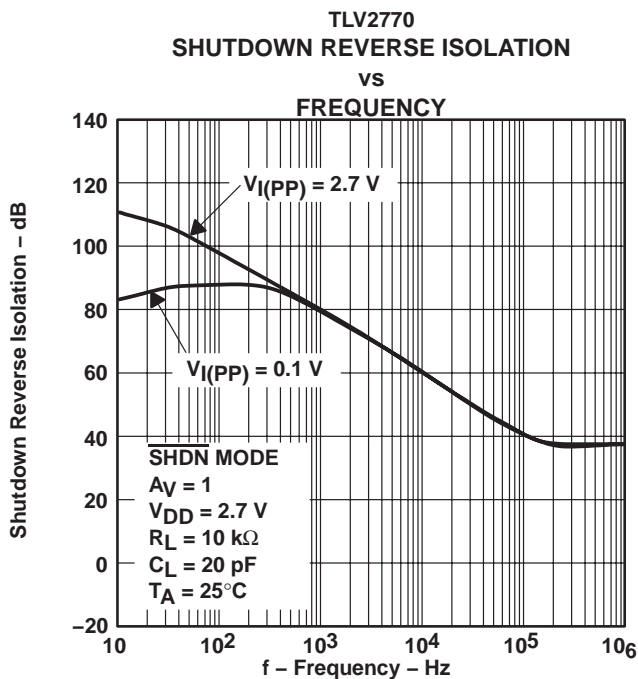

Figure 56

TLV277x, TLV277xA FAMILY OF 2.7-V HIGH-SLEW-RATE RAIL-TO-RAIL OUTPUT OPERATIONAL AMPLIFIERS WITH SHUTDOWN

SLOS096 "JANUARY 1998 REVISED FEBRUARY 2004" [查询 TLV277 供应链](#)

PARAMETER MEASUREMENT INFORMATION

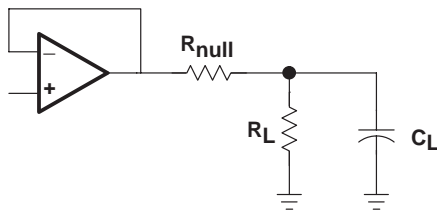

Figure 57

driving a capacitive load

When the amplifier is configured in this manner, capacitive loading directly on the output will decrease the device's phase margin leading to high frequency ringing or oscillations. Therefore, for capacitive loads of greater than 10 pF, it is recommended that a resistor be placed in series (R_{NULL}) with the output of the amplifier, as shown in Figure 58. A minimum value of 20 Ω should work well for most applications.

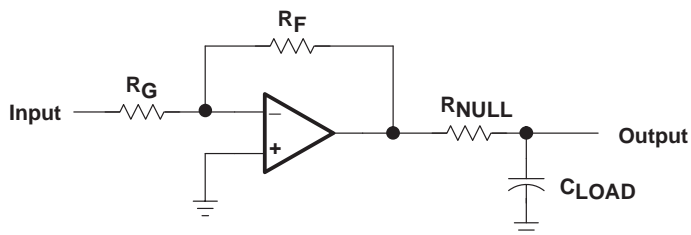

Figure 58. Driving a Capacitive Load

APPLICATION INFORMATION

offset voltage

The output offset voltage, (V_{OO}) is the sum of the input offset voltage (V_{IO}) and both input bias currents (I_{IB}) times the corresponding gains. The following schematic and formula can be used to calculate the output offset voltage:

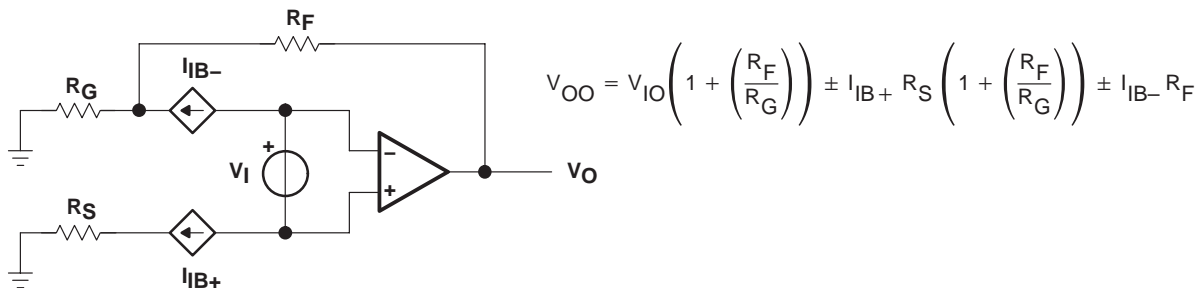

Figure 59. Output Offset Voltage Model

general configurations

When receiving low-level signals, limiting the bandwidth of the incoming signals into the system is often required. The simplest way to accomplish this is to place an RC filter at the noninverting terminal of the amplifier (see Figure 60).

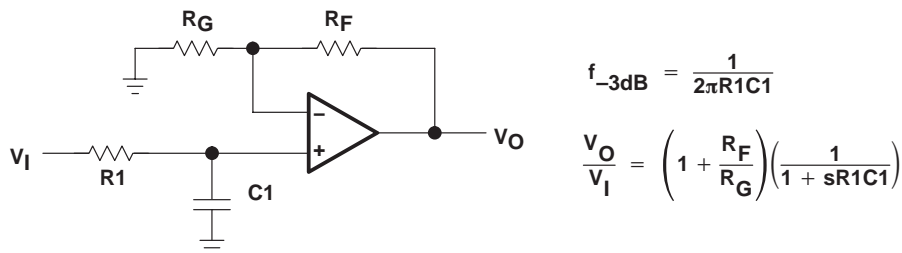

Figure 60. Single-Pole Low-Pass Filter

If even more attenuation is needed, a multiple pole filter is required. The Sallen-Key filter can be used for this task. For best results, the amplifier should have a bandwidth that is 8 to 10 times the filter frequency bandwidth. Failure to do this can result in phase shift of the amplifier.

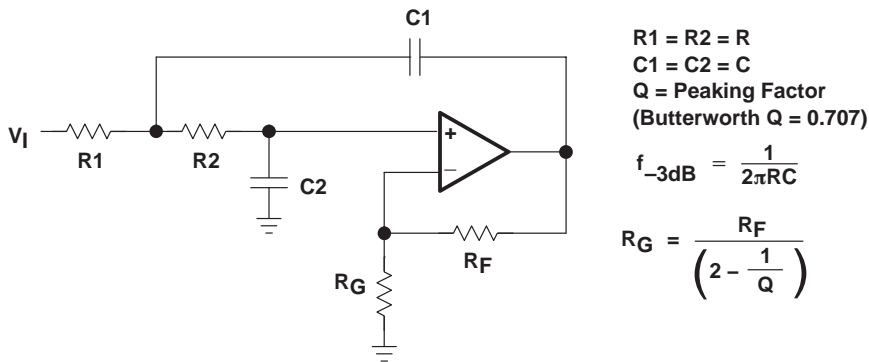

Figure 61. 2-Pole Low-Pass Sallen-Key Filter

TLV277x, TLV277xA FAMILY OF 2.7-V HIGH-SLEW-RATE RAIL-TO-RAIL OUTPUT OPERATIONAL AMPLIFIERS WITH SHUTDOWN

SLOS099C "TLV277" (REVISED) FEBRUARY 2004

APPLICATION INFORMATION

using the TLV2772 as an accelerometer interface

The schematic, shown in Figure 62, shows the ACH04-08-05 interfaced to the TLV1544 10-bit analog-to-digital converter (ADC).

The ACH04-08-05 is a shock sensor designed to convert mechanical acceleration into electrical signals. The sensor contains three piezoelectric sensing elements oriented to simultaneously measure acceleration in three orthogonal, linear axes (x, y, z). The operating frequency is 0.5 Hz to 5 kHz. The output is buffered with an internal JFET and has a typical output voltage of 1.80 mV/g for the x and y axis and 1.35 mV/g for the z axis.

Amplification and frequency shaping of the shock sensor output is done by the TLV2772 rail-to-rail operational amplifier. The TLV2772 is ideal for this application as it offers high input impedance, good slew rate, and excellent dc precision. The rail-to-rail output swing and high output drive are perfect for driving the analog input of the TLV1544 ADC.



Figure 62. Accelerometer Interface Schematic

The sensor signal must be amplified and frequency-shaped to provide a signal the ADC can properly convert into the digital domain. Figure 62 shows the topology used in this application for one axis of the sensor. This system is powered from a single 3-V supply. Configuring the TLV431 with a 2.2-kΩ resistor produces a reference voltage of 1.23 V. This voltage is used to bias the operational amplifier and the internal JFETs in the shock sensor.

APPLICATION INFORMATION

gain calculation

Since the TLV2772 is capable of rail-to-rail output using a 3-V supply, $V_O = 0$ (min) to 3 V (max). With no signal from the sensor, nominal $V_O =$ reference voltage = 1.23 V. Therefore, the maximum negative swing from nominal is $0\text{ V} - 1.23\text{ V} = -1.23\text{ V}$ and the maximum positive swing is $3\text{ V} - 1.23\text{ V} = 1.77\text{ V}$. By modeling the shock sensor as a low impedance voltage source with output of 2.25 mV/g (max) in the x and y axis and 1.70 mV/g (max) in the z axis, the gain of the circuit is calculated by equation 1.

$$\text{Gain} = \frac{\text{Output Swing}}{\text{Sensor Signal} \times \text{Acceleration}} \quad (1)$$

To avoid saturation of the operational amplifier, the gain calculations are based on the maximum negative swing of -1.23 V and the maximum sensor output of 2.25 mV/g (x and y axis) and 1.70 mV/g (z axis).

$$\text{Gain (x, y)} = \frac{-1.23\text{ V}}{2.25\text{ mV/g} \times -50\text{ g}} = 10.9 \quad (2)$$

and

$$\text{Gain (z)} = \frac{-1.23\text{ V}}{1.70\text{ mV/g} \times -50\text{ g}} = 14.5 \quad (3)$$

By selecting $R_3 = 10\text{ k}\Omega$ and $R_4 = 100\text{ k}\Omega$, in the x and y channels, a gain of 11 is realized. By selecting $R_3 = 7.5\text{ k}\Omega$ and $R_4 = 100\text{ k}\Omega$, in the z channel, a gain of 14.3 is realized. The schematic shows the configuration for either the x- or y-axis.

bandwidth calculation

To calculate the component values for the frequency shaping characteristics of the signal conditioning circuit, 1 Hz and 500 Hz are selected as the minimum required 3-dB bandwidth.

To minimize the value of the input capacitor (C1) required to set the lower cutoff frequency requires a large value resistor for R2 is required. A 1-M Ω resistor is used in this example. To set the lower cutoff frequency, the required capacitor value for C1 is:

$$C1 = \frac{1}{2\pi f_{\text{LOW}} R_2} = 0.159\text{ }\mu\text{F} \quad (4)$$

Using a value of 0.22 μF , a more common value of capacitor, the lower cutoff frequency is 0.724 Hz.

To minimize the phase shift in the feedback loop caused by the input capacitance of the TLV2772, it is best to minimize the value of the feedback resistor R4. However, to reduce the required capacitance in the feedback loop a large value for R4 is required. Therefore, a compromise for the value of R4 must be made. In this circuit, a value of 100 k Ω has been selected. To set the upper cutoff frequency, the required capacitor value for C2 is:

$$C2 = \frac{1}{2\pi f_{\text{HIGH}} R_4} = 3.18\text{ }\mu\text{F} \quad (5)$$

Using a 2.2-nF capacitor, the upper cutoff frequency is 724 Hz.

R5 and C3 also cause the signal response to roll off. Therefore, it is beneficial to design this roll-off point to begin at the upper cutoff frequency. Assuming a value of 1 k Ω for R5, the value for C3 is calculated to be 0.22 μF .

TLV277x, TLV277xA FAMILY OF 2.7-V HIGH-SLEW-RATE RAIL-TO-RAIL OUTPUT OPERATIONAL AMPLIFIERS WITH SHUTDOWN

SLOS099C "JANUARY 1998 REVISION D FEBRUARY 2004
查询 TLV2772 供应链

APPLICATION INFORMATION

circuit layout considerations

To achieve the levels of high performance of the TLV277x, follow proper printed-circuit board design techniques. A general set of guidelines is given in the following.

- Ground planes—It is highly recommended that a ground plane be used on the board to provide all components with a low inductive ground connection. However, in the areas of the amplifier inputs and output, the ground plane can be removed to minimize the stray capacitance.
- Proper power supply decoupling—Use a 6.8- μ F tantalum capacitor in parallel with a 0.1- μ F ceramic capacitor on each supply terminal. It may be possible to share the tantalum among several amplifiers depending on the application, but a 0.1- μ F ceramic capacitor should always be used on the supply terminal of every amplifier. In addition, the 0.1- μ F capacitor should be placed as close as possible to the supply terminal. As this distance increases, the inductance in the connecting trace makes the capacitor less effective. The designer should strive for distances of less than 0.1 inches between the device power terminals and the ceramic capacitors.
- Sockets—Sockets can be used but are not recommended. The additional lead inductance in the socket pins will often lead to stability problems. Surface-mount packages soldered directly to the printed-circuit board is the best implementation.
- Short trace runs/compact part placements—Optimum high performance is achieved when stray series inductance has been minimized. To realize this, the circuit layout should be made as compact as possible, thereby minimizing the length of all trace runs. Particular attention should be paid to the inverting input of the amplifier. Its length should be kept as short as possible. This will help to minimize stray capacitance at the input of the amplifier.
- Surface-mount passive components—Using surface-mount passive components is recommended for high performance amplifier circuits for several reasons. First, because of the extremely low lead inductance of surface-mount components, the problem with stray series inductance is greatly reduced. Second, the small size of surface-mount components naturally leads to a more compact layout thereby minimizing both stray inductance and capacitance. If leaded components are used, it is recommended that the lead lengths be kept as short as possible.

APPLICATION INFORMATION

general power dissipation considerations

For a given θ_{JA} , the maximum power dissipation is shown in Figure 63 and is calculated by the following formula:

$$P_D = \left(\frac{T_{MAX} - T_A}{\theta_{JA}} \right)$$

Where:

- P_D = Maximum power dissipation of TLV277x IC (watts)
- T_{MAX} = Absolute maximum junction temperature (150°C)
- T_A = Free-ambient air temperature (°C)
- $\theta_{JA} = \theta_{JC} + \theta_{CA}$
- θ_{JC} = Thermal coefficient from junction to case
- θ_{CA} = Thermal coefficient from case to ambient air (°C/W)

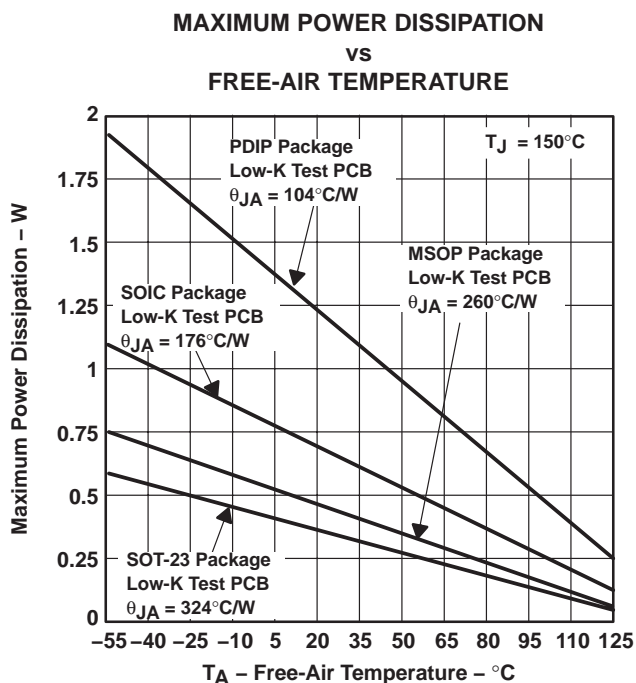

NOTE A: Results are with no air flow and using JEDEC Standard Low-K test PCB.

Figure 63. Maximum Power Dissipation vs Free-Air Temperature

TLV277x, TLV277xA FAMILY OF 2.7-V HIGH-SLEW-RATE RAIL-TO-RAIL OUTPUT OPERATIONAL AMPLIFIERS WITH SHUTDOWN

SLOS096 "ANNA" 1998 REVISED FEBRUARY 2004
查询 TLV277 供应信息

APPLICATION INFORMATION

shutdown function

Three members of the TLV277x family (TLV2770/3/5) have a shutdown terminal for conserving battery life in portable applications. When the shutdown terminal is tied low, the supply current is reduced to $0.8 \mu\text{A}/\text{channel}$, the amplifier is disabled, and the outputs are placed in a high impedance mode. To enable the amplifier, the shutdown terminal can either be left floating or pulled high. When the shutdown terminal is left floating, care needs to be taken to ensure that parasitic leakage current at the shutdown terminal does not inadvertently place the operational amplifier into shutdown. The shutdown terminal threshold is always referenced to $V_{DD}/2$. Therefore, when operating the device with split supply voltages (e.g. $\pm 2.5 \text{ V}$), the shutdown terminal needs to be pulled to V_{DD-} (not GND) to disable the operational amplifier.

The amplifier's output with a shutdown pulse is shown in Figures 48, 49, and 50. The amplifier is powered with a single 5-V supply and configured as a noninverting configuration with a gain of 5. The amplifier turnon and turnoff times are measured from the 50% point of the shutdown pulse to the 50% point of the output waveform. The times for the single, dual, and quad are listed in the data tables. The *bump* on the rising edge of the TLV2770 output waveform is due to the start-up circuit on the bias generator. For the dual and quad (TLV2773/5), this *bump* is attributed to the bias generator's start-up circuit as well as the crosstalk between the other channel(s), which are in shutdown.

Figures 55 and 56 show the amplifier's forward and reverse isolation in shutdown. The operational amplifier is powered by $\pm 1.35\text{-V}$ supplies and configured as a voltage follower ($A_V = 1$). The isolation performance is plotted across frequency for both 0.1 V_{PP} and 2.7 V_{PP} input signals. During normal operation, the amplifier would not be able to handle a 2.7-V_{PP} input signal with a supply voltage of $\pm 1.35 \text{ V}$ since it exceeds the common-mode input voltage range (V_{ICR}). However, this curve illustrates that the amplifier remains in shutdown even under a worst case scenario.

TLV277x, TLV277xA FAMILY OF 2.7-V HIGH-SLEW-RATE RAIL-TO-RAIL OUTPUT OPERATIONAL AMPLIFIERS WITH SHUTDOWN

SLOS209G – JANUARY 1998 – REVISED FEBRUARY 2004

查询"TLV2772"供应商

APPLICATION INFORMATION

macromodel information

Macromodel information provided was derived using Microsim *Parts*™ Release 8, the model generation software used with Microsim *PSpice*™. The Boyle macromodel (see Note 4) and subcircuit in Figure 64 are generated using the TLV2772 typical electrical and operating characteristics at $T_A = 25^\circ\text{C}$. Using this information, output simulations of the following key parameters can be generated to a tolerance of 20% (in most cases):

- | | |
|---|--------------------------------------|
| ● Maximum positive output voltage swing | ● Unity-gain frequency |
| ● Maximum negative output voltage swing | ● Common-mode rejection ratio |
| ● Slew rate | ● Phase margin |
| ● Quiescent power dissipation | ● DC output resistance |
| ● Input bias current | ● AC output resistance |
| ● Open-loop voltage amplification | ● Short-circuit output current limit |

NOTE 4: G. R. Boyle, B. M. Cohn, D. O. Pederson, and J. E. Solomon, "Macromodeling of Integrated Circuit Operational Amplifiers", *IEEE Journal of Solid-State Circuits*, SC-9, 353 (1974).

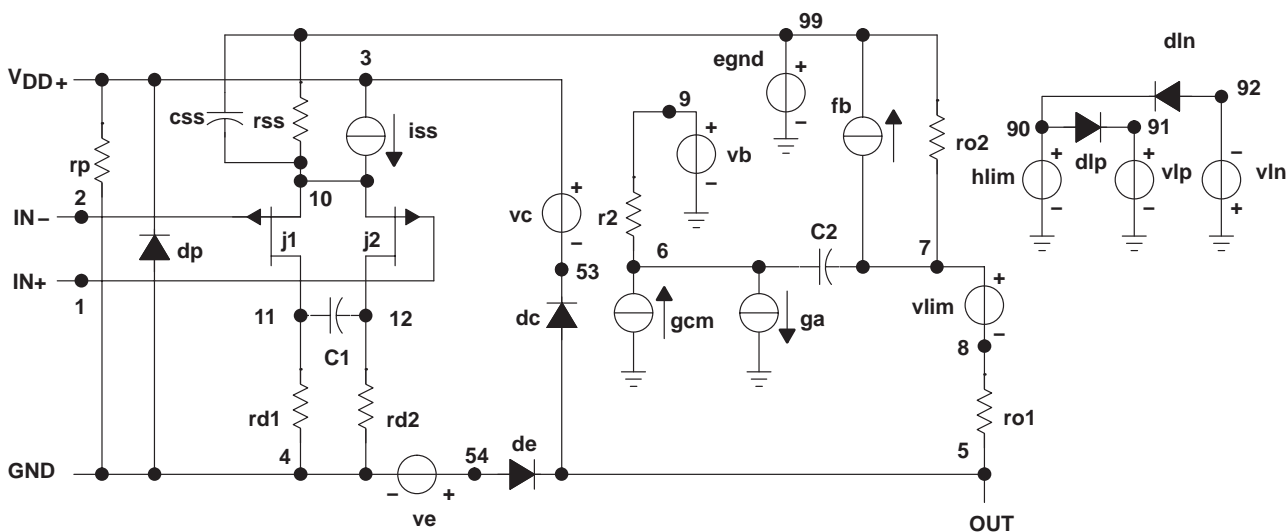

```

* TLV2772 operational amplifier macromodel subcircuit
* created using Parts release 8.0 on 12/12/97 at 10:08
* Parts is a MicroSim product.
*
* connections: noninverting input
*              |
*              | inverting input
*              | positive power supply
*              | negative power supply
*              | output
*
*.subckt TLV2772      1 2 3 4 5
c1      11      12      2.8868E-12
c2      6       7       10.000E-12
css     10      99      2.6302E-12
dc      5       53      dy
de      54      5       dy
dlp     90      91      dx
dln     92      90      dx
dp      4       3       dx
egnd    99      0       poly(2) (3,0) (4,0) 0 .5 .5
fb      7       99      poly(5) vb vc ve vlp vln 0
                        15.513E6 -1E3 1E3 16E6 -16E6
ga      6       0       11 12 188.50E-6
gcm     0       6       10 99 9.4472E-9
iss     3       10      dc 145.50E-6
hlim    90      0       vlim 1K
j1      11      2       10 jx1
j2      12      1       10 jx2
r2      6       9       100.00E3
rd1     4       11      5.3052E3
rd2     4       12      5.3052E3
ro1     8       5       17.140
ro2     7       99      17.140
rp      3       4       4.5455E3
r2      10     99      1.3746E6
vb      9       0       dc 0
vc      3       53      dc .82001
ve      54      4       dc .82001
vlim    7       8       dc 0
vlp     91      0       dc 47
vln     0       92      dc 47
.model  dx      D(Is=800.00E-18)
.model  dy      D(Is=800.00E-18 Rs=1m Cjo=10p)
.model  jx1     PjF(Is=2.2500E-12 Beta=244.20E-6
                  + Vto=-.99765)
.model  jx2     PjF(Is=1.7500E-12 Beta=244.20E-6
                  + Vto=-1.002350)
.ends
*$
    
```

Figure 64. Boyle Macromodel and Subcircuit

PSpice and *Parts* are trademarks of MicroSim Corporation.



www.ti.com

PACKAG

PACKAGING INFORMATION

Orderable Device	Status ⁽¹⁾	Package Type	Package Drawing	Pins	Package Qty	Eco Plan ⁽²⁾	Lead/Ball Finish	MSL Pe
5962-9858801Q2A	ACTIVE	LCCC	FK	20	1	TBD	POST-PLATE	N / A for Pkg
5962-9858801QHA	ACTIVE	CFP	U	10	1	TBD	A42	N / A for Pkg
5962-9858801QPA	ACTIVE	CDIP	JG	8	1	TBD	A42	N / A for Pkg
5962-9858802Q2A	ACTIVE	LCCC	FK	20	1	TBD	POST-PLATE	N / A for Pkg
5962-9858802QHA	ACTIVE	CFP	U	10	1	TBD	A42	N / A for Pkg
5962-9858802QPA	ACTIVE	CDIP	JG	8	1	TBD	A42	N / A for Pkg
TLV2770AID	ACTIVE	SOIC	D	8	75	Green (RoHS & no Sb/Br)	CU NIPDAU	Level-1-2600
TLV2770AIDG4	ACTIVE	SOIC	D	8	75	Green (RoHS & no Sb/Br)	CU NIPDAU	Level-1-2600
TLV2770AIP	ACTIVE	PDIP	P	8	50	Pb-Free (RoHS)	CU NIPDAU	N / A for Pkg
TLV2770AIPe4	ACTIVE	PDIP	P	8	50	Pb-Free (RoHS)	CU NIPDAU	N / A for Pkg
TLV2770CD	ACTIVE	SOIC	D	8	75	Green (RoHS & no Sb/Br)	CU NIPDAU	Level-1-2600
TLV2770CDG4	ACTIVE	SOIC	D	8	75	Green (RoHS & no Sb/Br)	CU NIPDAU	Level-1-2600
TLV2770CDR	ACTIVE	SOIC	D	8	2500	Green (RoHS & no Sb/Br)	CU NIPDAU	Level-1-2600
TLV2770CDRG4	ACTIVE	SOIC	D	8	2500	Green (RoHS & no Sb/Br)	CU NIPDAU	Level-1-2600
TLV2770CP	ACTIVE	PDIP	P	8	50	Pb-Free (RoHS)	CU NIPDAU	N / A for Pkg
TLV2770CPE4	ACTIVE	PDIP	P	8	50	Pb-Free (RoHS)	CU NIPDAU	N / A for Pkg
TLV2770IDGKR	ACTIVE	MSOP	DGK	8	2500	Green (RoHS & no Sb/Br)	CU NIPDAU	Level-1-2600
TLV2770IDGKRG4	ACTIVE	MSOP	DGK	8	2500	Green (RoHS & no Sb/Br)	CU NIPDAU	Level-1-2600
TLV2770IDR	ACTIVE	SOIC	D	8	2500	Green (RoHS & no Sb/Br)	CU NIPDAU	Level-1-2600
TLV2770IDRG4	ACTIVE	SOIC	D	8	2500	Green (RoHS & no Sb/Br)	CU NIPDAU	Level-1-2600
TLV2770IP	ACTIVE	PDIP	P	8	50	Pb-Free (RoHS)	CU NIPDAU	N / A for Pkg
TLV2770IPE4	ACTIVE	PDIP	P	8	50	Pb-Free (RoHS)	CU NIPDAU	N / A for Pkg



www.ti.com

PACKAG

Orderable Device	Status ⁽¹⁾	Package Type	Package Drawing	Pins	Package Qty	Eco Plan ⁽²⁾	Lead/ Ball Finish	MSL Pea
TLV2771AIDR	ACTIVE	SOIC	D	8	2500	Green (RoHS & no Sb/Br)	CU NIPDAU	Level-1-2600
TLV2771AIDRG4	ACTIVE	SOIC	D	8	2500	Green (RoHS & no Sb/Br)	CU NIPDAU	Level-1-2600
TLV2771CD	ACTIVE	SOIC	D	8	75	Green (RoHS & no Sb/Br)	CU NIPDAU	Level-1-2600
TLV2771CDBVR	ACTIVE	SOT-23	DBV	5	3000	Green (RoHS & no Sb/Br)	CU NIPDAU	Level-1-2600
TLV2771CDBVRG4	ACTIVE	SOT-23	DBV	5	3000	Green (RoHS & no Sb/Br)	CU NIPDAU	Level-1-2600
TLV2771CDBVT	ACTIVE	SOT-23	DBV	5	250	Green (RoHS & no Sb/Br)	CU NIPDAU	Level-1-2600
TLV2771CDBVTG4	ACTIVE	SOT-23	DBV	5	250	Green (RoHS & no Sb/Br)	CU NIPDAU	Level-1-2600
TLV2771CDG4	ACTIVE	SOIC	D	8	75	Green (RoHS & no Sb/Br)	CU NIPDAU	Level-1-2600
TLV2771CDR	ACTIVE	SOIC	D	8	2500	Green (RoHS & no Sb/Br)	CU NIPDAU	Level-1-2600
TLV2771CDRG4	ACTIVE	SOIC	D	8	2500	Green (RoHS & no Sb/Br)	CU NIPDAU	Level-1-2600
TLV2771ID	ACTIVE	SOIC	D	8	75	Green (RoHS & no Sb/Br)	CU NIPDAU	Level-1-2600
TLV2771IDBVR	ACTIVE	SOT-23	DBV	5	3000	Green (RoHS & no Sb/Br)	CU NIPDAU	Level-1-2600
TLV2771IDBVRG4	ACTIVE	SOT-23	DBV	5	3000	Green (RoHS & no Sb/Br)	CU NIPDAU	Level-1-2600
TLV2771IDBVT	ACTIVE	SOT-23	DBV	5	250	Green (RoHS & no Sb/Br)	CU NIPDAU	Level-1-2600
TLV2771IDBVTG4	ACTIVE	SOT-23	DBV	5	250	Green (RoHS & no Sb/Br)	CU NIPDAU	Level-1-2600
TLV2771IDG4	ACTIVE	SOIC	D	8	75	Green (RoHS & no Sb/Br)	CU NIPDAU	Level-1-2600
TLV2771IDR	ACTIVE	SOIC	D	8	2500	Green (RoHS & no Sb/Br)	CU NIPDAU	Level-1-2600
TLV2771IDRG4	ACTIVE	SOIC	D	8	2500	Green (RoHS & no Sb/Br)	CU NIPDAU	Level-1-2600



www.ti.com

PACKAG

Orderable Device	Status ⁽¹⁾	Package Type	Package Drawing	Pins	Package Qty	Eco Plan ⁽²⁾	Lead/ Ball Finish	MSL Pea
TLV2772AID	ACTIVE	SOIC	D	8	75	Green (RoHS & no Sb/Br)	CU NIPDAU	Level-1-2600
TLV2772AIDG4	ACTIVE	SOIC	D	8	75	Green (RoHS & no Sb/Br)	CU NIPDAU	Level-1-2600
TLV2772AIDR	ACTIVE	SOIC	D	8	2500	Green (RoHS & no Sb/Br)	CU NIPDAU	Level-1-2600
TLV2772AIDRG4	ACTIVE	SOIC	D	8	2500	Green (RoHS & no Sb/Br)	CU NIPDAU	Level-1-2600
TLV2772AIP	ACTIVE	PDIP	P	8	50	Pb-Free (RoHS)	CU NIPDAU	N / A for Pkg
TLV2772AIPE4	ACTIVE	PDIP	P	8	50	Pb-Free (RoHS)	CU NIPDAU	N / A for Pkg
TLV2772AMD	ACTIVE	SOIC	D	8	75	TBD	CU NIPDAU	Level-1-2200
TLV2772AMDG4	ACTIVE	SOIC	D	8	75	Green (RoHS & no Sb/Br)	CU NIPDAU	Level-1-2600
TLV2772AMDR	ACTIVE	SOIC	D	8	2500	TBD	CU NIPDAU	Level-1-2200
TLV2772AMDRG4	ACTIVE	SOIC	D	8	2500	Green (RoHS & no Sb/Br)	CU NIPDAU	Level-1-2600
TLV2772AMFKB	ACTIVE	LCCC	FK	20	1	TBD	POST-PLATE	N / A for Pkg
TLV2772AMJGB	ACTIVE	CDIP	JG	8	1	TBD	A42	N / A for Pkg
TLV2772AMUB	ACTIVE	CFP	U	10	1	TBD	A42	N / A for Pkg
TLV2772AQD	ACTIVE	SOIC	D	8	75	Green (RoHS & no Sb/Br)	CU NIPDAU	Level-1-2600
TLV2772AQDG4	ACTIVE	SOIC	D	8	75	Green (RoHS & no Sb/Br)	CU NIPDAU	Level-1-2600
TLV2772AQDR	ACTIVE	SOIC	D	8	2500	Green (RoHS & no Sb/Br)	CU NIPDAU	Level-1-2600
TLV2772AQDRG4	ACTIVE	SOIC	D	8	2500	Green (RoHS & no Sb/Br)	CU NIPDAU	Level-1-2600
TLV2772AQPW	ACTIVE	TSSOP	PW	8	150	TBD	CU NIPDAU	Level-1-2200
TLV2772AQPWG4	ACTIVE	TSSOP	PW	8	150	Green (RoHS & no Sb/Br)	CU NIPDAU	Level-1-2600
TLV2772AQPWR	ACTIVE	TSSOP	PW	8	2000	TBD	CU NIPDAU	Level-1-2200



www.ti.com

PACKAG

Orderable Device	Status ⁽¹⁾	Package Type	Package Drawing	Pins	Package Qty	Eco Plan ⁽²⁾	Lead/ Ball Finish	MSL Pea
TLV2772AQPWRG4	ACTIVE	TSSOP	PW	8	2000	Green (RoHS & no Sb/Br)	CU NIPDAU	Level-1-2600
TLV2772CD	ACTIVE	SOIC	D	8	75	Green (RoHS & no Sb/Br)	CU NIPDAU	Level-1-2600
TLV2772CDG4	ACTIVE	SOIC	D	8	75	Green (RoHS & no Sb/Br)	CU NIPDAU	Level-1-2600
TLV2772CDGK	ACTIVE	MSOP	DGK	8	80	Green (RoHS & no Sb/Br)	CU NIPDAU	Level-1-2600
TLV2772CDGKG4	ACTIVE	MSOP	DGK	8	80	Green (RoHS & no Sb/Br)	CU NIPDAU	Level-1-2600
TLV2772CDGKR	ACTIVE	MSOP	DGK	8	2500	Green (RoHS & no Sb/Br)	CU NIPDAU	Level-1-2600
TLV2772CDGKRG4	ACTIVE	MSOP	DGK	8	2500	Green (RoHS & no Sb/Br)	CU NIPDAU	Level-1-2600
TLV2772CDR	ACTIVE	SOIC	D	8	2500	Green (RoHS & no Sb/Br)	CU NIPDAU	Level-1-2600
TLV2772CDRG4	ACTIVE	SOIC	D	8	2500	Green (RoHS & no Sb/Br)	CU NIPDAU	Level-1-2600
TLV2772CP	ACTIVE	PDIP	P	8	50	Pb-Free (RoHS)	CU NIPDAU	N / A for Pkg
TLV2772CPE4	ACTIVE	PDIP	P	8	50	Pb-Free (RoHS)	CU NIPDAU	N / A for Pkg
TLV2772ID	ACTIVE	SOIC	D	8	75	Green (RoHS & no Sb/Br)	CU NIPDAU	Level-1-2600
TLV2772IDG4	ACTIVE	SOIC	D	8	75	Green (RoHS & no Sb/Br)	CU NIPDAU	Level-1-2600
TLV2772IDGK	ACTIVE	MSOP	DGK	8	80	Green (RoHS & no Sb/Br)	CU NIPDAU	Level-1-2600
TLV2772IDGKG4	ACTIVE	MSOP	DGK	8	80	Green (RoHS & no Sb/Br)	CU NIPDAU	Level-1-2600
TLV2772IDGKR	ACTIVE	MSOP	DGK	8	2500	Green (RoHS & no Sb/Br)	CU NIPDAU	Level-1-2600
TLV2772IDGKRG4	ACTIVE	MSOP	DGK	8	2500	Green (RoHS & no Sb/Br)	CU NIPDAU	Level-1-2600
TLV2772IDR	ACTIVE	SOIC	D	8	2500	Green (RoHS & no Sb/Br)	CU NIPDAU	Level-1-2600
TLV2772IDRG4	ACTIVE	SOIC	D	8	2500	Green (RoHS & no Sb/Br)	CU NIPDAU	Level-1-2600



www.ti.com

PACKAG

Orderable Device	Status ⁽¹⁾	Package Type	Package Drawing	Pins	Package Qty	Eco Plan ⁽²⁾	Lead/ Ball Finish	MSL Pea
TLV2772IP	ACTIVE	PDIP	P	8	50	Pb-Free (RoHS)	CU NIPDAU	N / A for Pkg
TLV2772IPE4	ACTIVE	PDIP	P	8	50	Pb-Free (RoHS)	CU NIPDAU	N / A for Pkg
TLV2772MD	ACTIVE	SOIC	D	8	75	TBD	CU NIPDAU	Level-1-2200
TLV2772MDG4	ACTIVE	SOIC	D	8	75	Green (RoHS & no Sb/Br)	CU NIPDAU	Level-1-2600
TLV2772MDR	ACTIVE	SOIC	D	8	2500	TBD	CU NIPDAU	Level-1-2200
TLV2772MDRG4	ACTIVE	SOIC	D	8	2500	Green (RoHS & no Sb/Br)	CU NIPDAU	Level-1-2600
TLV2772MFKB	ACTIVE	LCCC	FK	20	1	TBD	POST-PLATE	N / A for Pkg
TLV2772MJGB	ACTIVE	CDIP	JG	8	1	TBD	A42	N / A for Pkg
TLV2772MUB	ACTIVE	CFP	U	10	1	TBD	A42	N / A for Pkg
TLV2772QD	ACTIVE	SOIC	D	8	75	Green (RoHS & no Sb/Br)	CU NIPDAU	Level-1-2600
TLV2772QDG4	ACTIVE	SOIC	D	8	75	Green (RoHS & no Sb/Br)	CU NIPDAU	Level-1-2600
TLV2772QDR	ACTIVE	SOIC	D	8	1500	Green (RoHS & no Sb/Br)	CU NIPDAU	Level-1-2600
TLV2772QDRG4	ACTIVE	SOIC	D	8	2500	Green (RoHS & no Sb/Br)	CU NIPDAU	Level-1-2600
TLV2772QPW	ACTIVE	TSSOP	PW	8	150	TBD	CU NIPDAU	Level-1-2200
TLV2772QPWG4	ACTIVE	TSSOP	PW	8	150	Green (RoHS & no Sb/Br)	CU NIPDAU	Level-1-2600
TLV2772QPWR	ACTIVE	TSSOP	PW	8	2000	TBD	CU NIPDAU	Level-1-2200
TLV2772QPWRG4	ACTIVE	TSSOP	PW	8	2000	Green (RoHS & no Sb/Br)	CU NIPDAU	Level-1-2600
TLV2773AIN	ACTIVE	PDIP	N	14	25	Pb-Free (RoHS)	CU NIPDAU	N / A for Pkg
TLV2773AINE4	ACTIVE	PDIP	N	14	25	Pb-Free (RoHS)	CU NIPDAU	N / A for Pkg
TLV2773CDGS	ACTIVE	MSOP	DGS	10	80	Green (RoHS & no Sb/Br)	CU NIPDAU	Level-1-2600
TLV2773CDGSG4	ACTIVE	MSOP	DGS	10	80	Green (RoHS & no Sb/Br)	CU NIPDAU	Level-1-2600

[查询"TLV2772"供应商](#)



www.ti.com

PACKAG

Orderable Device	Status ⁽¹⁾	Package Type	Package Drawing	Pins	Package Qty	Eco Plan ⁽²⁾	Lead/ Ball Finish	MSL Pea
TLV2773CDGSR	ACTIVE	MSOP	DGS	10	2500	Green (RoHS & no Sb/Br)	CU NIPDAU	Level-1-2600
TLV2773CDGSRG4	ACTIVE	MSOP	DGS	10	2500	Green (RoHS & no Sb/Br)	CU NIPDAU	Level-1-2600
TLV2773CDR	ACTIVE	SOIC	D	14	2500	Green (RoHS & no Sb/Br)	CU NIPDAU	Level-1-2600
TLV2773CDRG4	ACTIVE	SOIC	D	14	2500	Green (RoHS & no Sb/Br)	CU NIPDAU	Level-1-2600
TLV2773IDGS	ACTIVE	MSOP	DGS	10	80	Green (RoHS & no Sb/Br)	CU NIPDAU	Level-1-2600
TLV2773IDGSG4	ACTIVE	MSOP	DGS	10	80	Green (RoHS & no Sb/Br)	CU NIPDAU	Level-1-2600
TLV2773IDGSR	ACTIVE	MSOP	DGS	10	2500	Green (RoHS & no Sb/Br)	CU NIPDAU	Level-1-2600
TLV2773IDGSRG4	ACTIVE	MSOP	DGS	10	2500	Green (RoHS & no Sb/Br)	CU NIPDAU	Level-1-2600
TLV2773IDR	ACTIVE	SOIC	D	14	2500	Green (RoHS & no Sb/Br)	CU NIPDAU	Level-1-2600
TLV2773IDRG4	ACTIVE	SOIC	D	14	2500	Green (RoHS & no Sb/Br)	CU NIPDAU	Level-1-2600
TLV2773IN	ACTIVE	PDIP	N	14	25	Pb-Free (RoHS)	CU NIPDAU	N / A for Pkg
TLV2773INE4	ACTIVE	PDIP	N	14	25	Pb-Free (RoHS)	CU NIPDAU	N / A for Pkg
TLV2774AID	ACTIVE	SOIC	D	14	50	Green (RoHS & no Sb/Br)	CU NIPDAU	Level-1-2600
TLV2774AIDG4	ACTIVE	SOIC	D	14	50	Green (RoHS & no Sb/Br)	CU NIPDAU	Level-1-2600
TLV2774AIDR	ACTIVE	SOIC	D	14	2500	Green (RoHS & no Sb/Br)	CU NIPDAU	Level-1-2600
TLV2774AIDRG4	ACTIVE	SOIC	D	14	2500	Green (RoHS & no Sb/Br)	CU NIPDAU	Level-1-2600
TLV2774AIN	ACTIVE	PDIP	N	14	25	Pb-Free (RoHS)	CU NIPDAU	N / A for Pkg
TLV2774AINE4	ACTIVE	PDIP	N	14	25	Pb-Free (RoHS)	CU NIPDAU	N / A for Pkg
TLV2774AIPW	ACTIVE	TSSOP	PW	14	90	Green (RoHS & no Sb/Br)	CU NIPDAU	Level-1-2600



www.ti.com

PACKAG

Orderable Device	Status ⁽¹⁾	Package Type	Package Drawing	Pins	Package Qty	Eco Plan ⁽²⁾	Lead/ Ball Finish	MSL Peak
TLV2774AIPWG4	ACTIVE	TSSOP	PW	14	90	Green (RoHS & no Sb/Br)	CU NIPDAU	Level-1-2600
TLV2774CD	ACTIVE	SOIC	D	14	50	Green (RoHS & no Sb/Br)	CU NIPDAU	Level-1-2600
TLV2774CDG4	ACTIVE	SOIC	D	14	50	Green (RoHS & no Sb/Br)	CU NIPDAU	Level-1-2600
TLV2774CDR	ACTIVE	SOIC	D	14	2500	Green (RoHS & no Sb/Br)	CU NIPDAU	Level-1-2600
TLV2774CDRG4	ACTIVE	SOIC	D	14	2500	Green (RoHS & no Sb/Br)	CU NIPDAU	Level-1-2600
TLV2774CN	ACTIVE	PDIP	N	14	25	Pb-Free (RoHS)	CU NIPDAU	N / A for Pkg
TLV2774CNE4	ACTIVE	PDIP	N	14	25	Pb-Free (RoHS)	CU NIPDAU	N / A for Pkg
TLV2774CPW	ACTIVE	TSSOP	PW	14	90	Green (RoHS & no Sb/Br)	CU NIPDAU	Level-1-2600
TLV2774CPWG4	ACTIVE	TSSOP	PW	14	90	Green (RoHS & no Sb/Br)	CU NIPDAU	Level-1-2600
TLV2774CPWR	ACTIVE	TSSOP	PW	14	2000	Green (RoHS & no Sb/Br)	CU NIPDAU	Level-1-2600
TLV2774CPWRG4	ACTIVE	TSSOP	PW	14	2000	Green (RoHS & no Sb/Br)	CU NIPDAU	Level-1-2600
TLV2774ID	ACTIVE	SOIC	D	14	50	Green (RoHS & no Sb/Br)	CU NIPDAU	Level-1-2600
TLV2774IDG4	ACTIVE	SOIC	D	14	50	Green (RoHS & no Sb/Br)	CU NIPDAU	Level-1-2600
TLV2774IDR	ACTIVE	SOIC	D	14	2500	Green (RoHS & no Sb/Br)	CU NIPDAU	Level-1-2600
TLV2774IDRG4	ACTIVE	SOIC	D	14	2500	Green (RoHS & no Sb/Br)	CU NIPDAU	Level-1-2600
TLV2774IN	ACTIVE	PDIP	N	14	25	Pb-Free (RoHS)	CU NIPDAU	N / A for Pkg
TLV2774INE4	ACTIVE	PDIP	N	14	25	Pb-Free (RoHS)	CU NIPDAU	N / A for Pkg
TLV2774IPW	ACTIVE	TSSOP	PW	14	90	Green (RoHS & no Sb/Br)	CU NIPDAU	Level-1-2600
TLV2774IPWG4	ACTIVE	TSSOP	PW	14	90	Green (RoHS & no Sb/Br)	CU NIPDAU	Level-1-2600



www.ti.com

PACKAG

Orderable Device	Status ⁽¹⁾	Package Type	Package Drawing	Pins	Package Qty	Eco Plan ⁽²⁾	Lead/ Ball Finish	MSL Peak
TLV2774IPWR	ACTIVE	TSSOP	PW	14	2000	Green (RoHS & no Sb/Br)	CU NIPDAU	Level-1-2600
TLV2774IPWRG4	ACTIVE	TSSOP	PW	14	2000	Green (RoHS & no Sb/Br)	CU NIPDAU	Level-1-2600
TLV2775AIDR	ACTIVE	SOIC	D	16	2500	Green (RoHS & no Sb/Br)	CU NIPDAU	Level-1-2600
TLV2775AIDRG4	ACTIVE	SOIC	D	16	2500	Green (RoHS & no Sb/Br)	CU NIPDAU	Level-1-2600
TLV2775AIN	ACTIVE	PDIP	N	16	25	Pb-Free (RoHS)	CU NIPDAU	N / A for Pkg
TLV2775AINE4	ACTIVE	PDIP	N	16	25	Pb-Free (RoHS)	CU NIPDAU	N / A for Pkg
TLV2775AIPW	ACTIVE	TSSOP	PW	16	90	Green (RoHS & no Sb/Br)	CU NIPDAU	Level-1-2600
TLV2775AIPWG4	ACTIVE	TSSOP	PW	16	90	Green (RoHS & no Sb/Br)	CU NIPDAU	Level-1-2600
TLV2775CD	ACTIVE	SOIC	D	16	40	Green (RoHS & no Sb/Br)	CU NIPDAU	Level-1-2600
TLV2775CDG4	ACTIVE	SOIC	D	16	40	Green (RoHS & no Sb/Br)	CU NIPDAU	Level-1-2600
TLV2775CN	ACTIVE	PDIP	N	16	25	Pb-Free (RoHS)	CU NIPDAU	N / A for Pkg
TLV2775CNE4	ACTIVE	PDIP	N	16	25	Pb-Free (RoHS)	CU NIPDAU	N / A for Pkg
TLV2775ID	ACTIVE	SOIC	D	16	40	Green (RoHS & no Sb/Br)	CU NIPDAU	Level-1-2600
TLV2775IDG4	ACTIVE	SOIC	D	16	40	Green (RoHS & no Sb/Br)	CU NIPDAU	Level-1-2600
TLV2775IDR	ACTIVE	SOIC	D	16	2500	Green (RoHS & no Sb/Br)	CU NIPDAU	Level-1-2600
TLV2775IDRG4	ACTIVE	SOIC	D	16	2500	Green (RoHS & no Sb/Br)	CU NIPDAU	Level-1-2600
TLV2775IN	ACTIVE	PDIP	N	16	25	Pb-Free (RoHS)	CU NIPDAU	N / A for Pkg
TLV2775INE4	ACTIVE	PDIP	N	16	25	Pb-Free (RoHS)	CU NIPDAU	N / A for Pkg
TLV2775IPWR	ACTIVE	TSSOP	PW	16	2000	Green (RoHS & no Sb/Br)	CU NIPDAU	Level-1-2600
TLV2775IPWRG4	ACTIVE	TSSOP	PW	16	2000	Green (RoHS & no Sb/Br)	CU NIPDAU	Level-1-2600



www.ti.com

PACKAG

(1) The marketing status values are defined as follows:

ACTIVE: Product device recommended for new designs.

LIFEBUY: TI has announced that the device will be discontinued, and a lifetime-buy period is in effect.

NRND: Not recommended for new designs. Device is in production to support existing customers, but TI does not recommend using this part in a new design.

PREVIEW: Device has been announced but is not in production. Samples may or may not be available.

OBSOLETE: TI has discontinued the production of the device.

(2) Eco Plan - The planned eco-friendly classification: Pb-Free (RoHS), Pb-Free (RoHS Exempt), or Green (RoHS & no Sb/Br) - please check <http://www.ti.com> for more information and additional product content details.

TBD: The Pb-Free/Green conversion plan has not been defined.

Pb-Free (RoHS): TI's terms "Lead-Free" or "Pb-Free" mean semiconductor products that are compatible with the current RoHS requirements for all lead-based materials. Where designed to be soldered at high temperatures, TI Pb-Free products are suitable for use in applications that require high-temperature soldering.

Pb-Free (RoHS Exempt): This component has a RoHS exemption for either 1) lead-based flip-chip solder bumps used between the die and package, or 2) lead-based leadframe materials used in the die and leadframe. The component is otherwise considered Pb-Free (RoHS compatible) as defined above.

Green (RoHS & no Sb/Br): TI defines "Green" to mean Pb-Free (RoHS compatible), and free of Bromine (Br) and Antimony (Sb) based flame retardants (unless otherwise designated in TI literature). This qualification covers both the semiconductor device and the normal manufacturing process used to assemble the device into a final product (in homogeneous material).

(3) MSL, Peak Temp. -- The Moisture Sensitivity Level rating according to the JEDEC industry standard classifications, and peak solder temperature.

Important Information and Disclaimer: The information provided on this page represents TI's knowledge and belief as of the date that it is provided. TI does not warrant, represent, or guarantee the accuracy, reliability, or completeness of the information. TI and TI suppliers consider certain information to be proprietary, and thus CAS numbers and other limited information may not be available for release. Efforts are underway to better integrate information into TI's online tools and applications. TI is not responsible for the content of any third party, and makes no representation or warranty as to the accuracy of such information. Efforts are underway to better integrate information into TI's online tools and applications. TI continues to take reasonable steps to provide representative and accurate information but may not have conducted destructive testing or chemical analysis on all TI and TI suppliers consider certain information to be proprietary, and thus CAS numbers and other limited information may not be available for release.

In no event shall TI's liability arising out of such information exceed the total purchase price of the TI part(s) at issue in this document sold by TI to Customer.

OTHER QUALIFIED VERSIONS OF TLV2771, TLV2772, TLV2772A, TLV2772AM, TLV2772M, TLV2774, TLV2774A :

- Catalog: [TLV2772A](#), [TLV2772](#)
- Automotive: [TLV2771-Q1](#), [TLV2772-Q1](#), [TLV2772A-Q1](#), [TLV2772A-Q1](#), [TLV2772-Q1](#)
- Enhanced Product: [TLV2772A-EP](#), [TLV2772A-EP](#), [TLV2774-EP](#), [TLV2774A-EP](#)
- Military: [TLV2772M](#), [TLV2772AM](#)

NOTE: Qualified Version Definitions:

- Catalog - TI's standard catalog product

[查询"TLV2772"供应商](#)



www.ti.com

PACKAG

-
- Automotive - Q100 devices qualified for high-reliability automotive applications targeting zero defects
 - Enhanced Product - Supports Defense, Aerospace and Medical Applications
 - Military - QML certified for Military and Defense Applications

TAPE AND REEL INFORMATION



QUADRANT ASSIGNMENTS FOR PIN 1 ORIENTATION IN TAPE



*All dimensions are nominal

Device	Package Type	Package Drawing	Pins	SPQ	Reel Diameter (mm)	Reel Width W1 (mm)	A0 (mm)	B0 (mm)	K0 (mm)	P1 (mm)	W (mm)	Pin1 Quadrant
TLV2770CDR	SOIC	D	8	2500	330.0	12.4	6.4	5.2	2.1	8.0	12.0	Q1
TLV2770IDGKR	MSOP	DGK	8	2500	330.0	12.4	5.3	3.4	1.4	8.0	12.0	Q1
TLV2770IDR	SOIC	D	8	2500	330.0	12.4	6.4	5.2	2.1	8.0	12.0	Q1
TLV2771AIDR	SOIC	D	8	2500	330.0	12.4	6.4	5.2	2.1	8.0	12.0	Q1
TLV2771CDBVR	SOT-23	DBV	5	3000	180.0	9.0	3.15	3.2	1.4	4.0	8.0	Q3
TLV2771CDBVT	SOT-23	DBV	5	250	180.0	9.0	3.15	3.2	1.4	4.0	8.0	Q3
TLV2771CDR	SOIC	D	8	2500	330.0	12.4	6.4	5.2	2.1	8.0	12.0	Q1
TLV2771IDBVR	SOT-23	DBV	5	3000	180.0	9.2	3.23	3.17	1.37	4.0	8.0	Q3
TLV2771IDBVT	SOT-23	DBV	5	250	180.0	9.2	3.23	3.17	1.37	4.0	8.0	Q3
TLV2771IDR	SOIC	D	8	2500	330.0	12.4	6.4	5.2	2.1	8.0	12.0	Q1
TLV2772AIDR	SOIC	D	8	2500	330.0	12.4	6.4	5.2	2.1	8.0	12.0	Q1
TLV2772AQPWR	TSSOP	PW	8	2000	330.0	12.4	7.0	3.6	1.6	8.0	12.0	Q1
TLV2772CDGKR	MSOP	DGK	8	2500	330.0	12.4	5.3	3.4	1.4	8.0	12.0	Q1
TLV2772CDR	SOIC	D	8	2500	330.0	12.4	6.4	5.2	2.1	8.0	12.0	Q1
TLV2772IDGKR	MSOP	DGK	8	2500	330.0	12.4	5.3	3.4	1.4	8.0	12.0	Q1
TLV2772IDR	SOIC	D	8	2500	330.0	12.4	6.4	5.2	2.1	8.0	12.0	Q1
TLV2772QPWR	TSSOP	PW	8	2000	330.0	12.4	7.0	3.6	1.6	8.0	12.0	Q1
TLV2773CDGSR	MSOP	DGS	10	2500	330.0	12.4	5.3	3.4	1.4	8.0	12.0	Q1

Device	Package Type	Package Drawing	Pins	SPQ	Reel Diameter (mm)	Reel Width W1 (mm)	A0 (mm)	B0 (mm)	K0 (mm)	P1 (mm)	W (mm)	Pin1 Quadrant
TLV2773CDR	SOIC	D	14	2500	330.0	16.4	6.5	9.0	2.1	8.0	16.0	Q1
TLV2773IDGSR	MSOP	DGS	10	2500	330.0	12.4	5.3	3.4	1.4	8.0	12.0	Q1
TLV2773IDR	SOIC	D	14	2500	330.0	16.4	6.5	9.0	2.1	8.0	16.0	Q1
TLV2774AIDR	SOIC	D	14	2500	330.0	16.4	6.5	9.0	2.1	8.0	16.0	Q1
TLV2774CDR	SOIC	D	14	2500	330.0	16.4	6.5	9.0	2.1	8.0	16.0	Q1
TLV2774CPWR	TSSOP	PW	14	2000	330.0	12.4	6.9	5.6	1.6	8.0	12.0	Q1
TLV2774IDR	SOIC	D	14	2500	330.0	16.4	6.5	9.0	2.1	8.0	16.0	Q1
TLV2774IPWR	TSSOP	PW	14	2000	330.0	12.4	6.9	5.6	1.6	8.0	12.0	Q1
TLV2775AIDR	SOIC	D	16	2500	330.0	16.4	6.5	10.3	2.1	8.0	16.0	Q1
TLV2775IDR	SOIC	D	16	2500	330.0	16.4	6.5	10.3	2.1	8.0	16.0	Q1
TLV2775IPWR	TSSOP	PW	16	2000	330.0	12.4	6.9	5.6	1.6	8.0	12.0	Q1
TLV2775IPWRG4	TSSOP	PW	16	2000	330.0	12.4	6.9	5.6	1.6	8.0	12.0	Q1

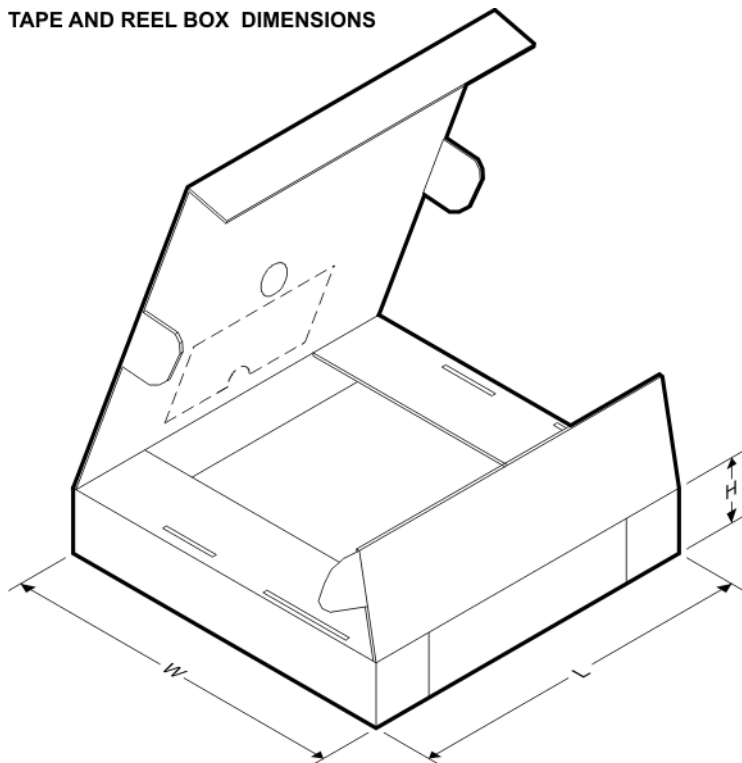
TAPE AND REEL BOX DIMENSIONS

*All dimensions are nominal

Device	Package Type	Package Drawing	Pins	SPQ	Length (mm)	Width (mm)	Height (mm)
TLV2770CDR	SOIC	D	8	2500	340.5	338.1	20.6
TLV2770IDGKR	MSOP	DGK	8	2500	358.0	335.0	35.0
TLV2770IDR	SOIC	D	8	2500	340.5	338.1	20.6
TLV2771AIDR	SOIC	D	8	2500	340.5	338.1	20.6
TLV2771CDBVR	SOT-23	DBV	5	3000	182.0	182.0	20.0

Device	Package Type	Package Drawing	Pins	SPQ	Length (mm)	Width (mm)	Height (mm)
TLV2771CDBVT	SOT-23	DBV	5	250	182.0	182.0	20.0
TLV2771CDR	SOIC	D	8	2500	340.5	338.1	20.6
TLV2771IDBVR	SOT-23	DBV	5	3000	202.0	201.0	28.0
TLV2771IDBVT	SOT-23	DBV	5	250	202.0	201.0	28.0
TLV2771IDR	SOIC	D	8	2500	340.5	338.1	20.6
TLV2772AIDR	SOIC	D	8	2500	340.5	338.1	20.6
TLV2772AQPWR	TSSOP	PW	8	2000	346.0	346.0	29.0
TLV2772CDGKR	MSOP	DGK	8	2500	358.0	335.0	35.0
TLV2772CDR	SOIC	D	8	2500	340.5	338.1	20.6
TLV2772IDGKR	MSOP	DGK	8	2500	358.0	335.0	35.0
TLV2772IDR	SOIC	D	8	2500	340.5	338.1	20.6
TLV2772QPWR	TSSOP	PW	8	2000	346.0	346.0	29.0
TLV2773CDGSR	MSOP	DGS	10	2500	358.0	335.0	35.0
TLV2773CDR	SOIC	D	14	2500	346.0	346.0	33.0
TLV2773IDGSR	MSOP	DGS	10	2500	358.0	335.0	35.0
TLV2773IDR	SOIC	D	14	2500	346.0	346.0	33.0
TLV2774AIDR	SOIC	D	14	2500	346.0	346.0	33.0
TLV2774CDR	SOIC	D	14	2500	346.0	346.0	33.0
TLV2774CPWR	TSSOP	PW	14	2000	346.0	346.0	29.0
TLV2774IDR	SOIC	D	14	2500	346.0	346.0	33.0
TLV2774IPWR	TSSOP	PW	14	2000	346.0	346.0	29.0
TLV2775AIDR	SOIC	D	16	2500	346.0	346.0	33.0
TLV2775IDR	SOIC	D	16	2500	346.0	346.0	33.0
TLV2775IPWR	TSSOP	PW	16	2000	346.0	346.0	29.0
TLV2775IPWRG4	TSSOP	PW	16	2000	346.0	346.0	29.0

JG (R-GDIP-T8)

CERAMIC DUAL-IN-LINE

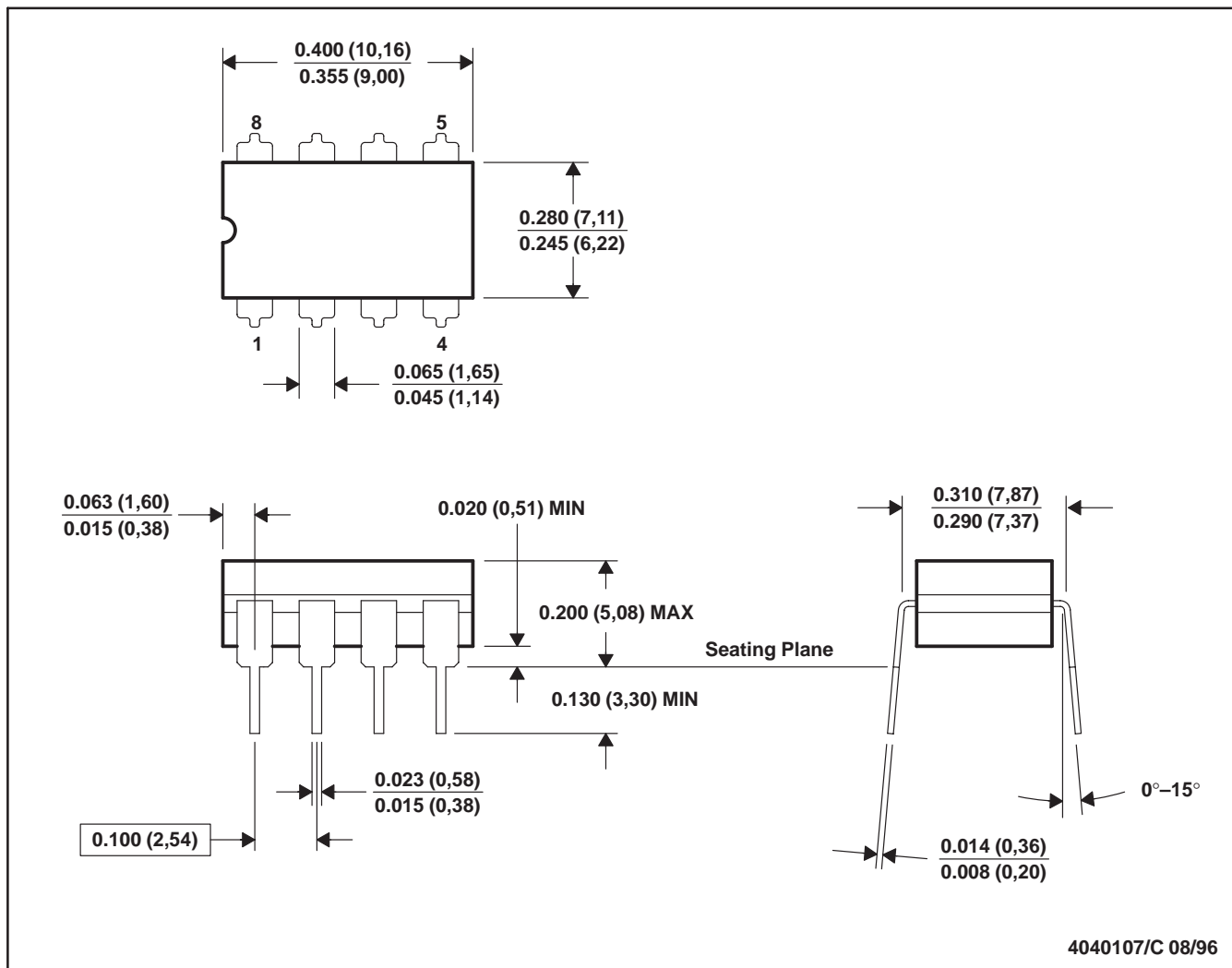

- NOTES: A. All linear dimensions are in inches (millimeters).
 B. This drawing is subject to change without notice.
 C. This package can be hermetically sealed with a ceramic lid using glass frit.
 D. Index point is provided on cap for terminal identification.
 E. Falls within MIL STD 1835 GDIP1-T8

[查询"TLV2772"供应商](#)

U (S-GDFP-F10)

CERAMIC DUAL FLATPACK

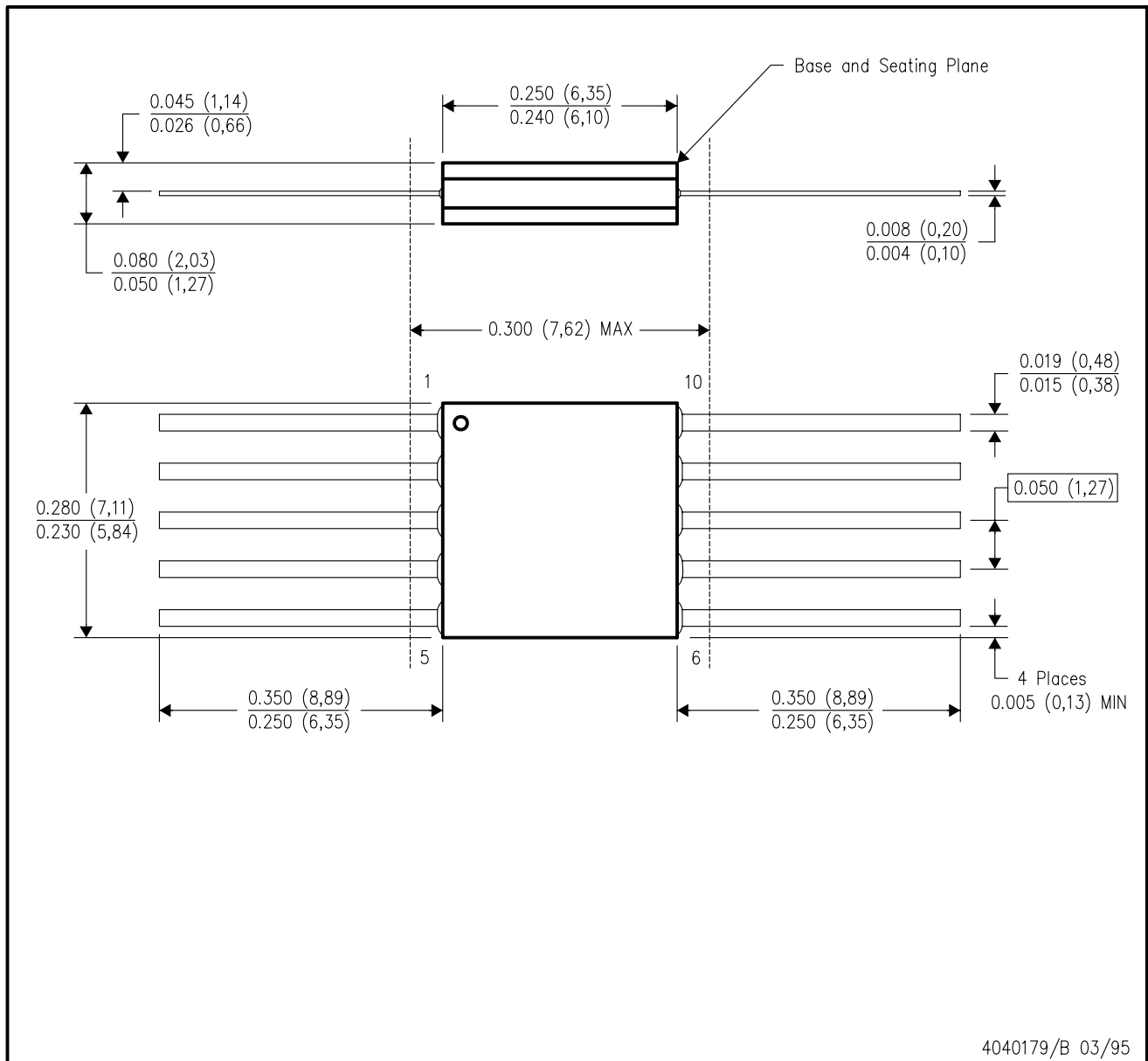

- NOTES:
- All linear dimensions are in inches (millimeters).
 - This drawing is subject to change without notice.
 - This package can be hermetically sealed with a ceramic lid using glass frit.
 - Index point is provided on cap for terminal identification only.
 - Falls within MIL STD 1835 GDFP1-F10 and JEDEC MO-092AA

FK (S-CQCC-N**)

LEADLESS CERAMIC CHIP CARRIER

28 TERMINAL SHOWN

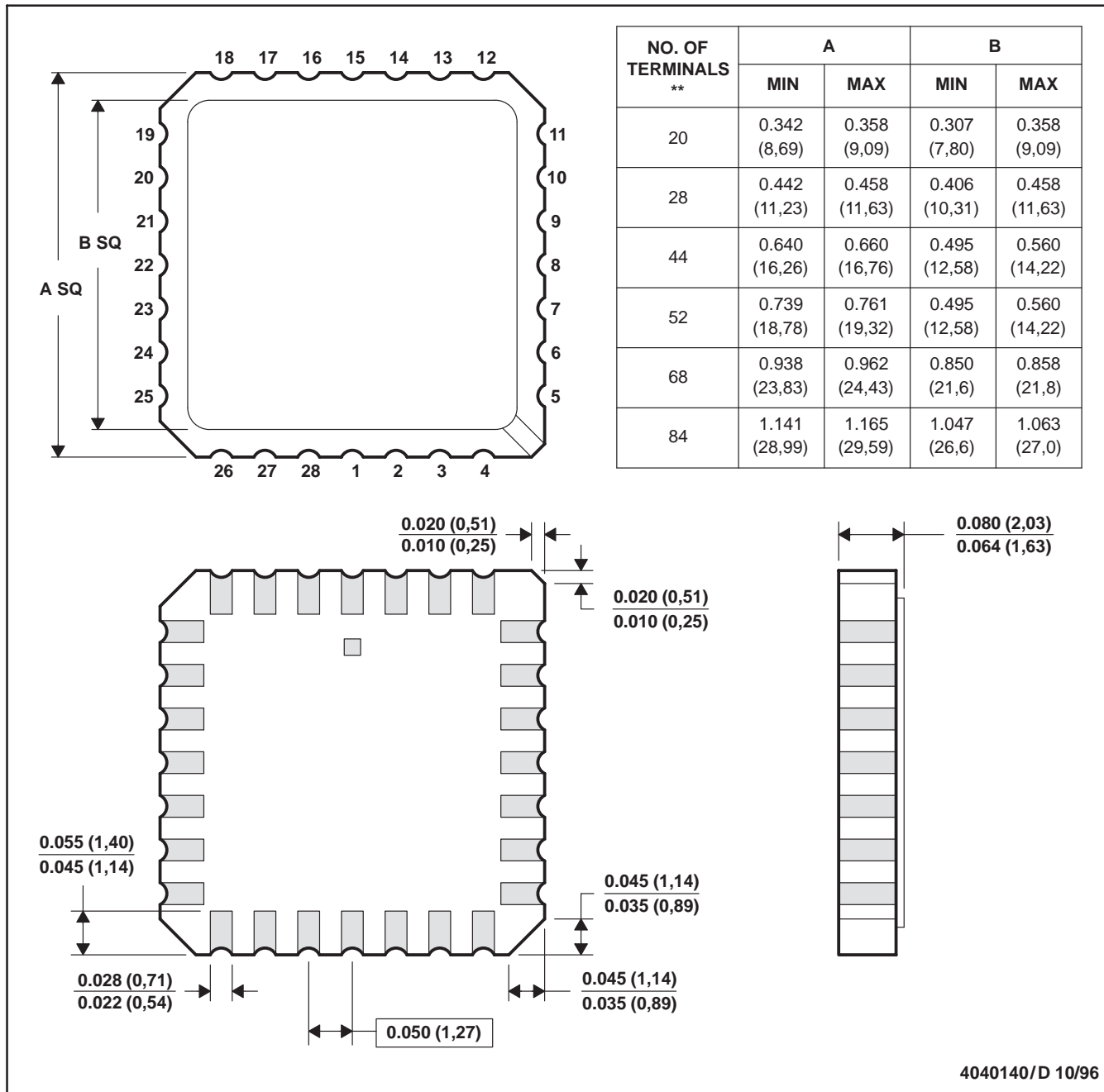

- NOTES:
- A. All linear dimensions are in inches (millimeters).
 - B. This drawing is subject to change without notice.
 - C. This package can be hermetically sealed with a metal lid.
 - D. The terminals are gold plated.
 - E. Falls within JEDEC MS-004

[查询"TLV2772"供应商](#)

P (R-PDIP-T8)

PLASTIC DUAL-IN-LINE PACKAGE

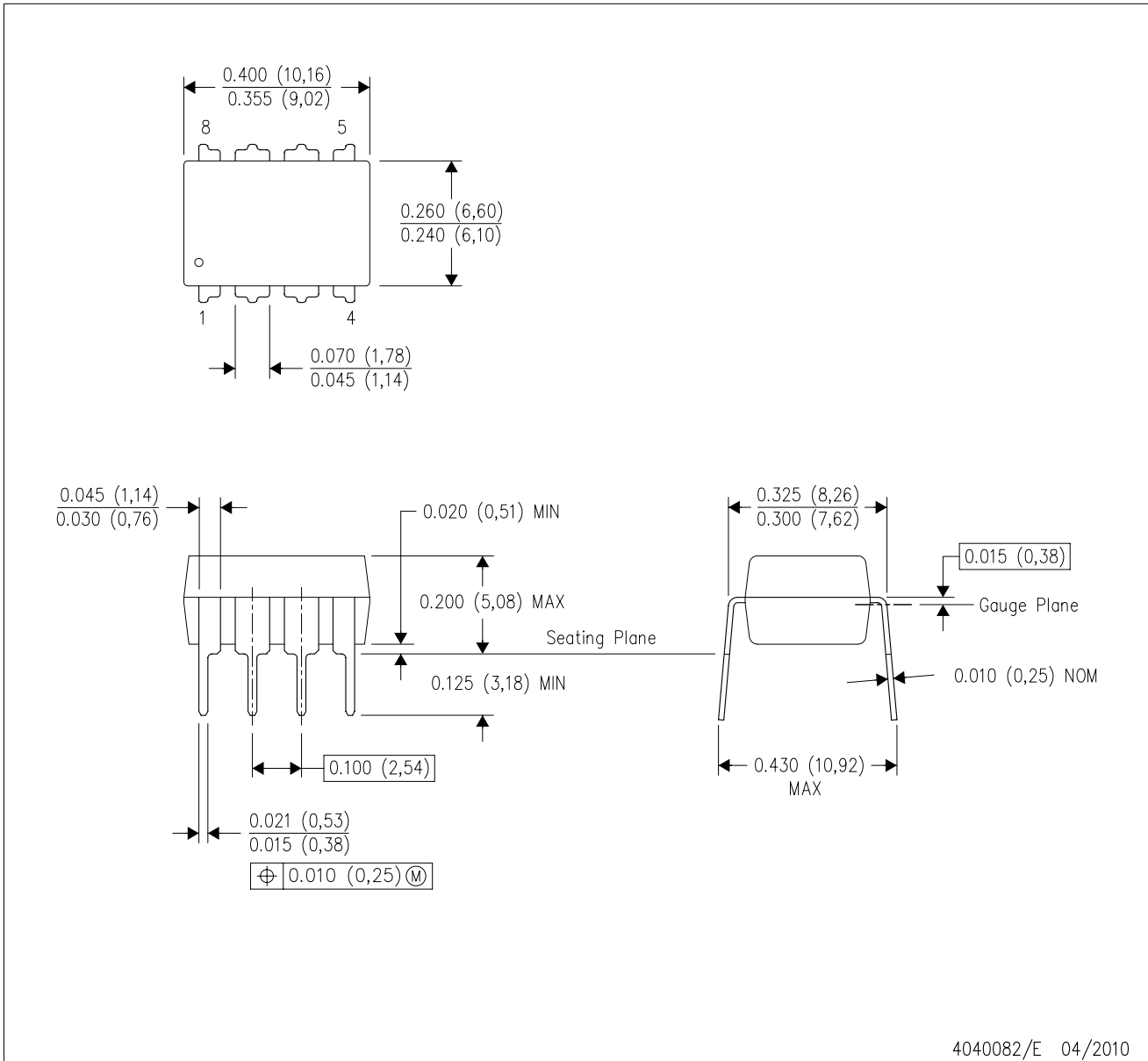

[查询"TLV2772"供应商](#)

N (R-PDIP-T**)

PLASTIC DUAL-IN-LINE PACKAGE

16 PINS SHOWN

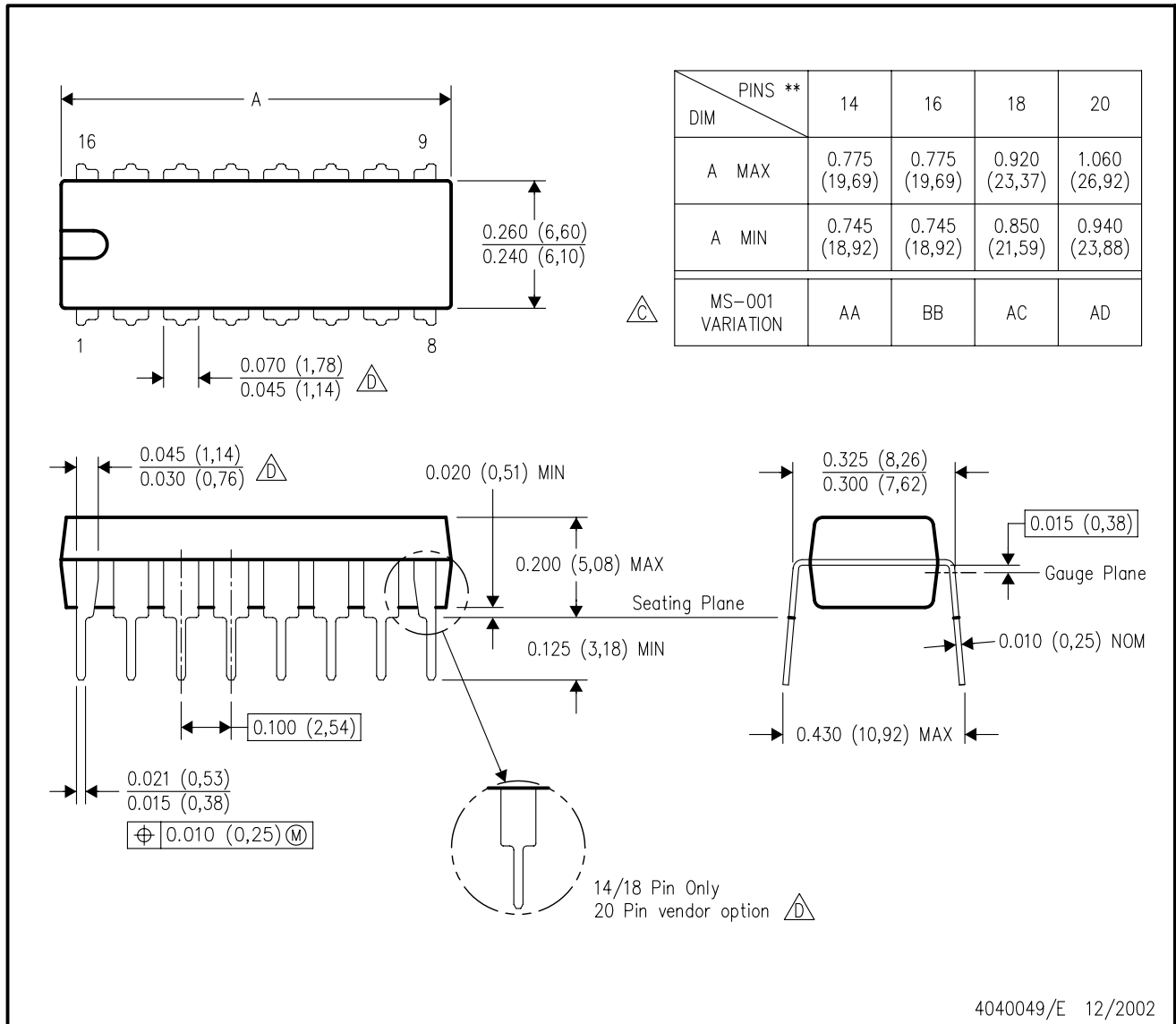

- NOTES:
- A. All linear dimensions are in inches (millimeters).
 - B. This drawing is subject to change without notice.
 - Falls within JEDEC MS-001, except 18 and 20 pin minimum body length (Dim A).
 - The 20 pin end lead shoulder width is a vendor option, either half or full width.

[查询"TLV2772"供应商](#)

DBV (R-PDSO-G5)

PLASTIC SMALL-OUTLINE PACKAGE

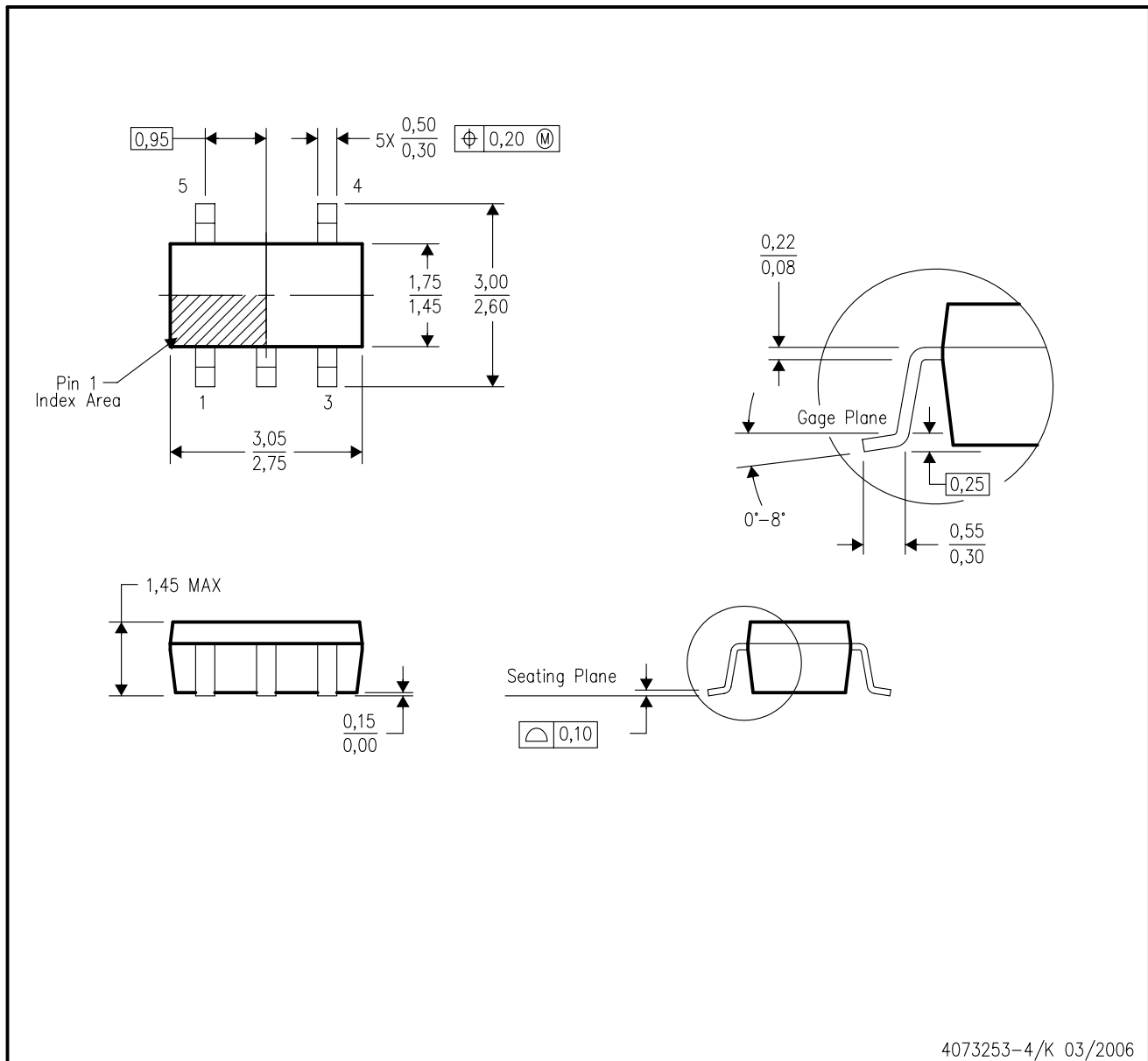

- NOTES:
- All linear dimensions are in millimeters.
 - This drawing is subject to change without notice.
 - Body dimensions do not include mold flash or protrusion. Mold flash and protrusion shall not exceed 0.15 per side.
 - Falls within JEDEC MO-178 Variation AA.

[查询"TLV2772"供应商](#)

DGK (S-PDSO-G8)

PLASTIC SMALL-OUTLINE PACKAGE

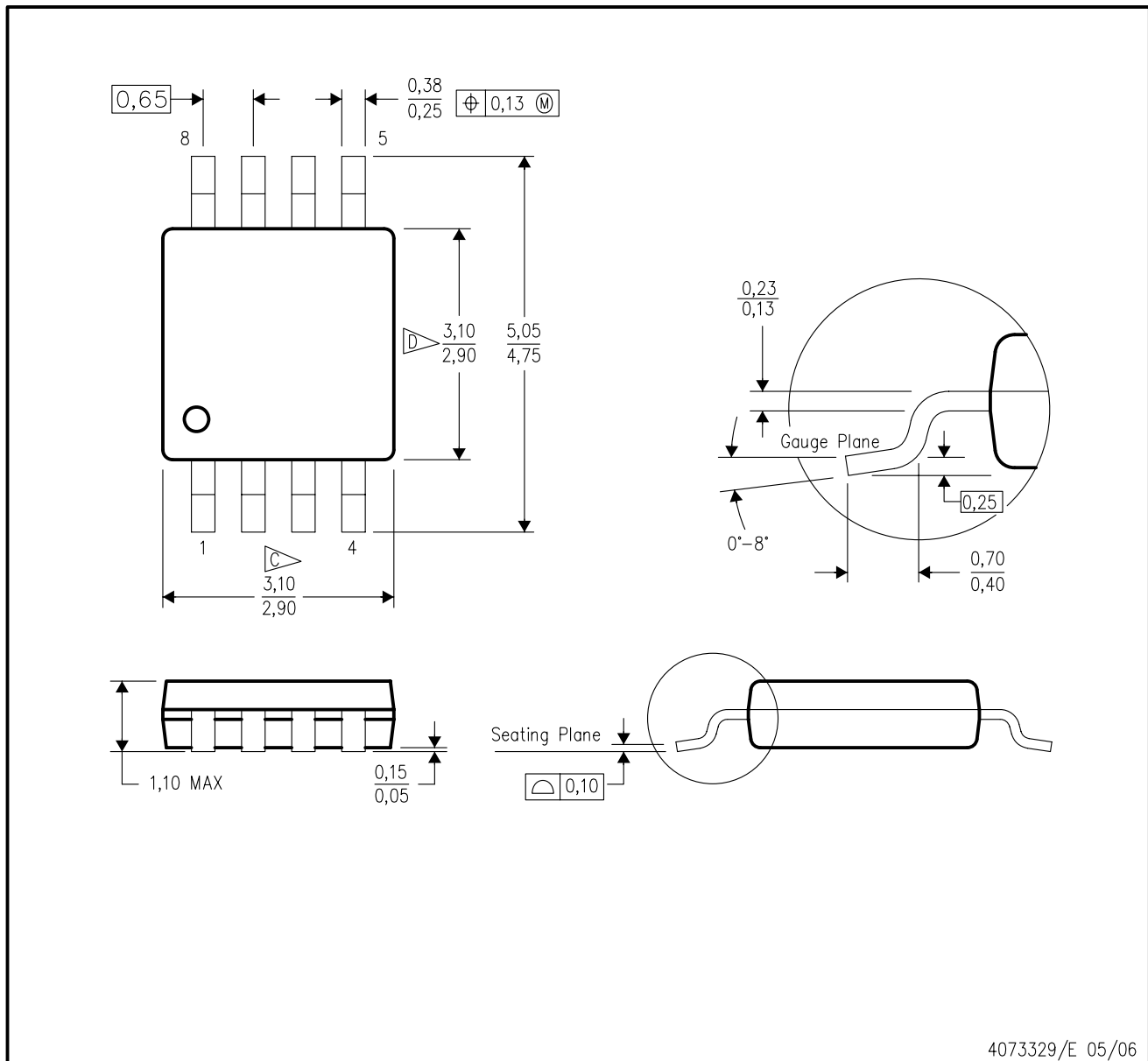

- NOTES:
- All linear dimensions are in millimeters.
 - This drawing is subject to change without notice.
 - Body length does not include mold flash, protrusions, or gate burrs. Mold flash, protrusions, or gate burrs shall not exceed 0.15 per end.
 - Body width does not include interlead flash. Interlead flash shall not exceed 0.50 per side.
 - Falls within JEDEC MO-187 variation AA, except interlead flash.

[查询"TLV2772"供应商](#)

DGS (S-PDSO-G10)

PLASTIC SMALL-OUTLINE PACKAGE

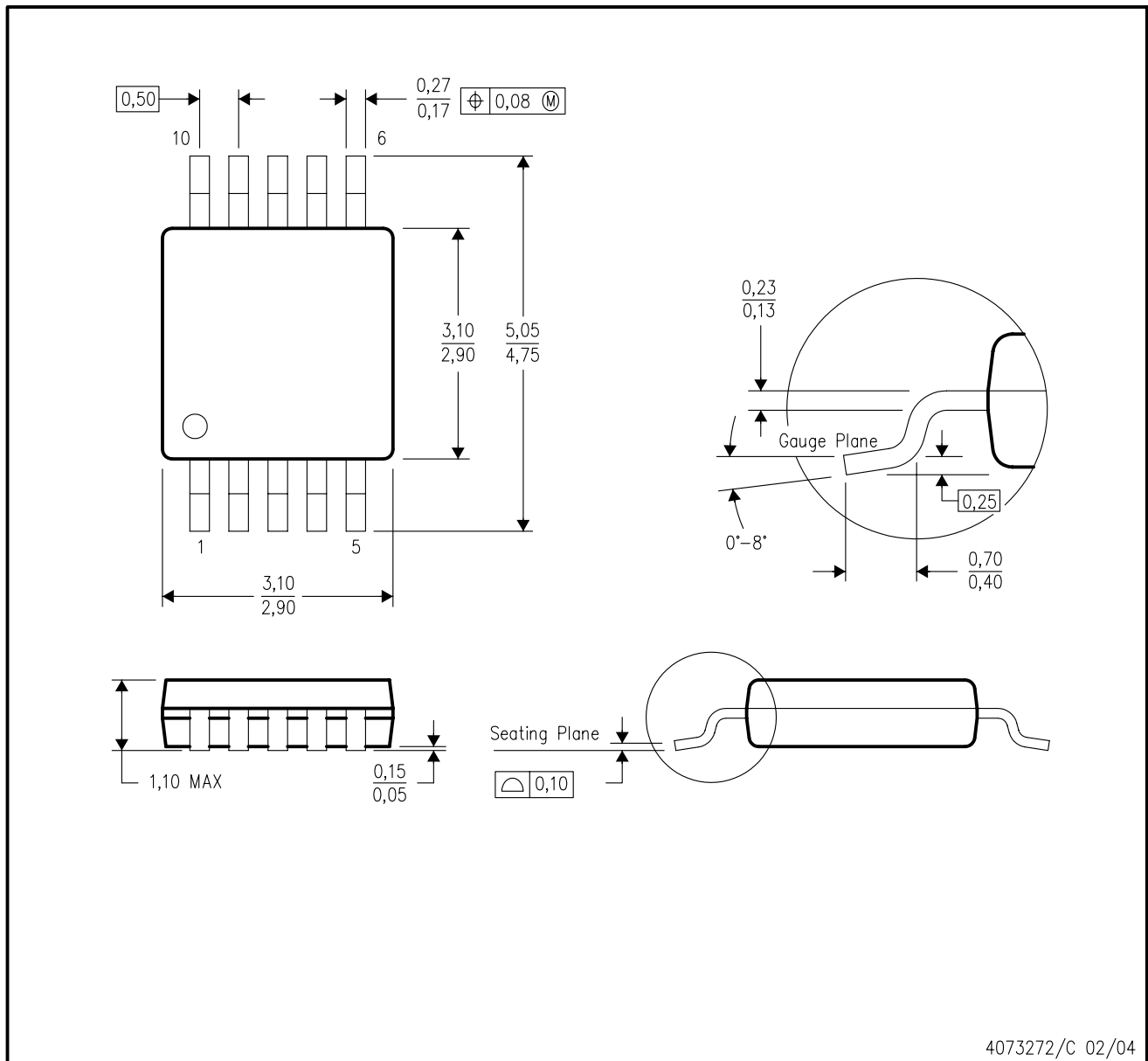

- NOTES:
- All linear dimensions are in millimeters.
 - This drawing is subject to change without notice.
 - Body dimensions do not include mold flash or protrusion.
 - Falls within JEDEC MO-187 variation BA.

[查询"TLV2772"供应商](#)

D (R-PDSO-G14)

PLASTIC SMALL-OUTLINE PACKAGE

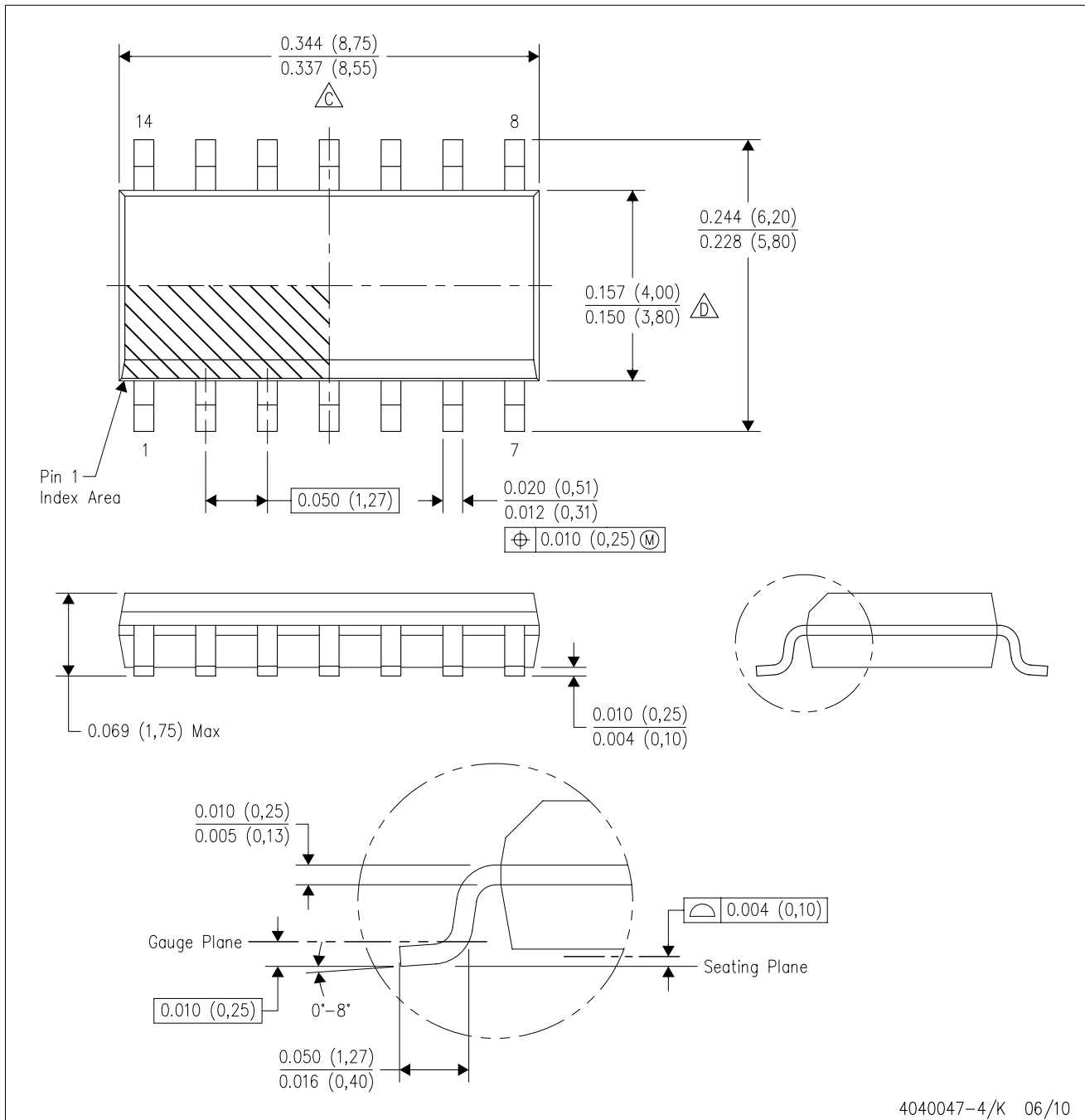

- NOTES:
- A. All linear dimensions are in inches (millimeters).
 - B. This drawing is subject to change without notice.
 - C. Body length does not include mold flash, protrusions, or gate burrs. Mold flash, protrusions, or gate burrs shall not exceed .006 (0,15) per end.
 - D. Body width does not include interlead flash. Interlead flash shall not exceed .017 (0,43) per side.
 - E. Reference JEDEC MS-012 variation AB.

D (R-PDSO-G14)

PLASTIC SMALL OUTLINE

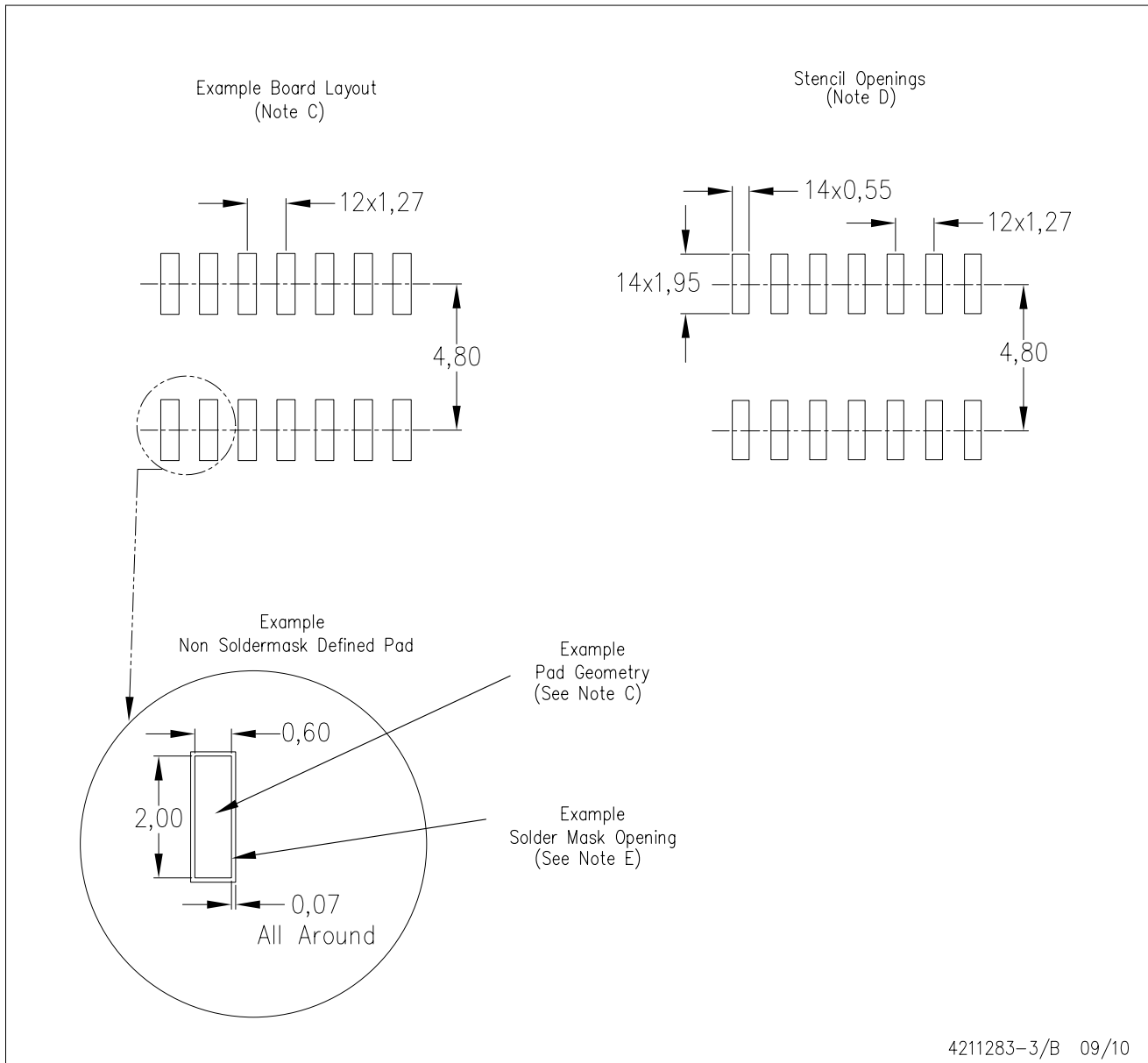

- NOTES:
- All linear dimensions are in millimeters.
 - This drawing is subject to change without notice.
 - Publication IPC-7351 is recommended for alternate designs.
 - Laser cutting apertures with trapezoidal walls and also rounding corners will offer better paste release. Customers should contact their board assembly site for stencil design recommendations. Refer to IPC-7525 for other stencil recommendations.
 - Customers should contact their board fabrication site for solder mask tolerances between and around signal pads.

[查询"TLV2772"供应商](#)

D (R-PDSO-G16)

PLASTIC SMALL-OUTLINE PACKAGE

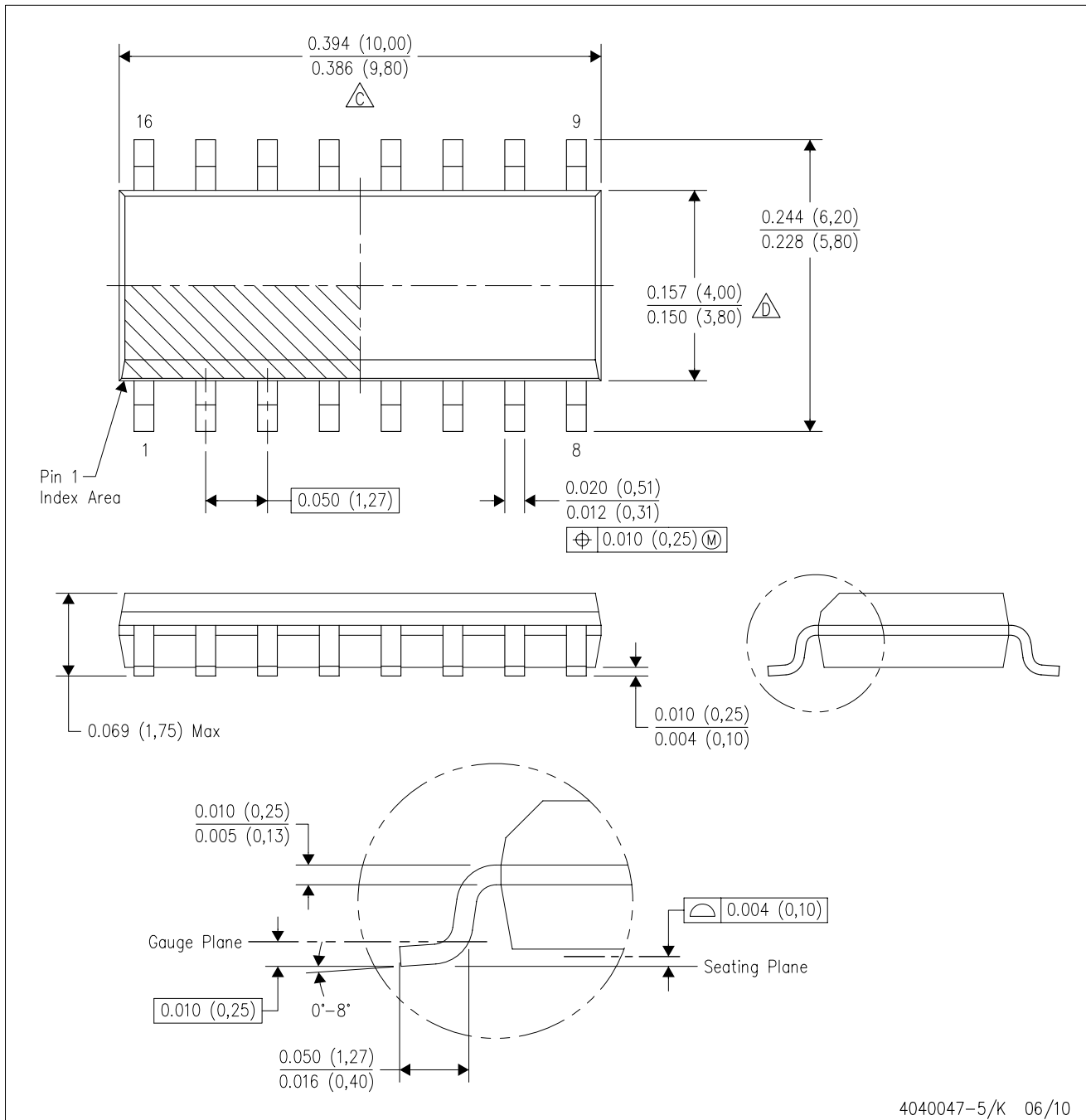

- NOTES:
- A. All linear dimensions are in inches (millimeters).
 - B. This drawing is subject to change without notice.
 - C. Body length does not include mold flash, protrusions, or gate burrs. Mold flash, protrusions, or gate burrs shall not exceed .006 (0,15) per end.
 - D. Body width does not include interlead flash. Interlead flash shall not exceed .017 (0,43) per side.
 - E. Reference JEDEC MS-012 variation AC.

D (R-PDSO-G16)

PLASTIC SMALL OUTLINE

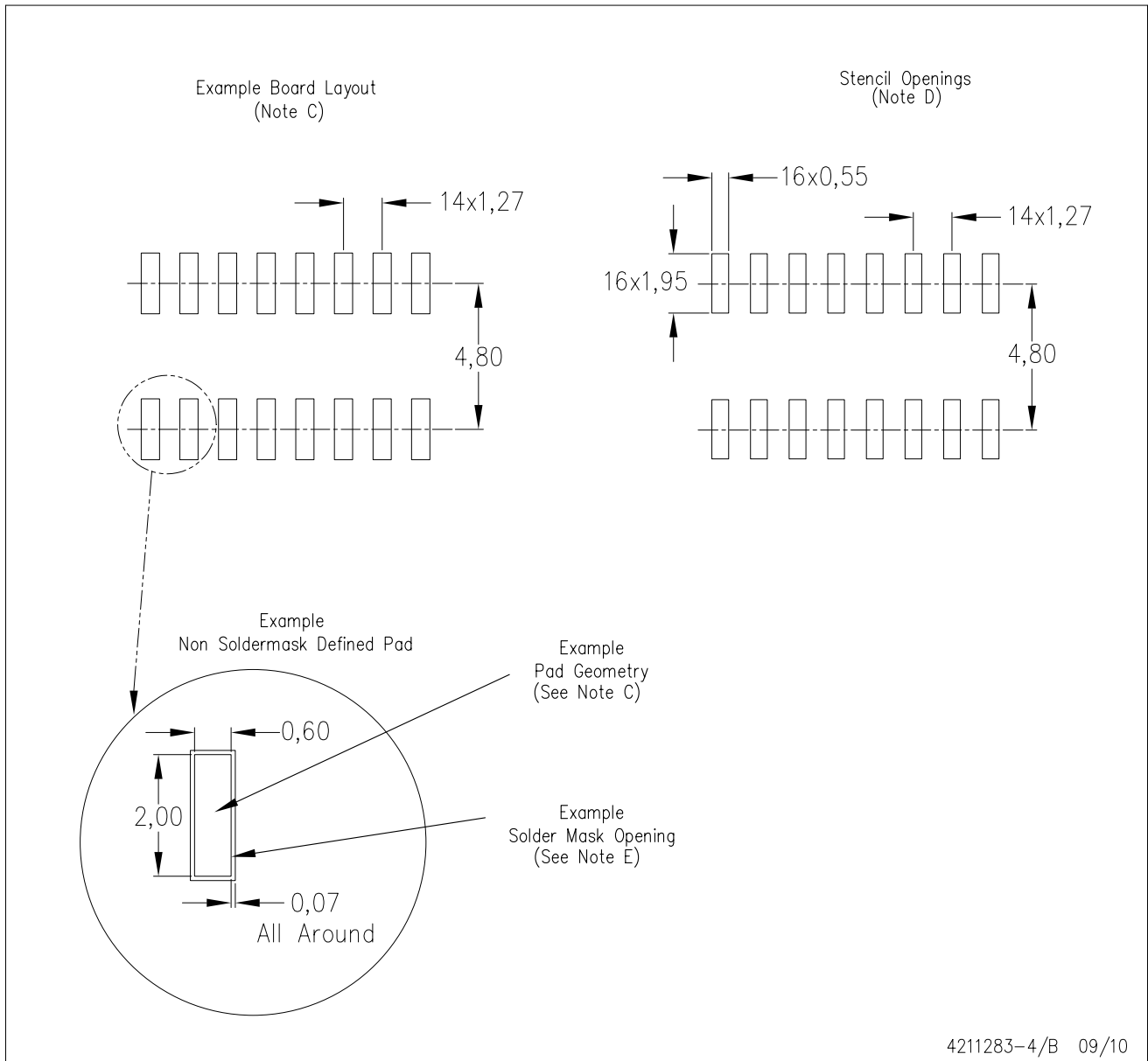

- NOTES:
- All linear dimensions are in millimeters.
 - This drawing is subject to change without notice.
 - Publication IPC-7351 is recommended for alternate designs.
 - Laser cutting apertures with trapezoidal walls and also rounding corners will offer better paste release. Customers should contact their board assembly site for stencil design recommendations. Refer to IPC-7525 for other stencil recommendations.
 - Customers should contact their board fabrication site for solder mask tolerances between and around signal pads.

D (R-PDSO-G8)

PLASTIC SMALL-OUTLINE PACKAGE

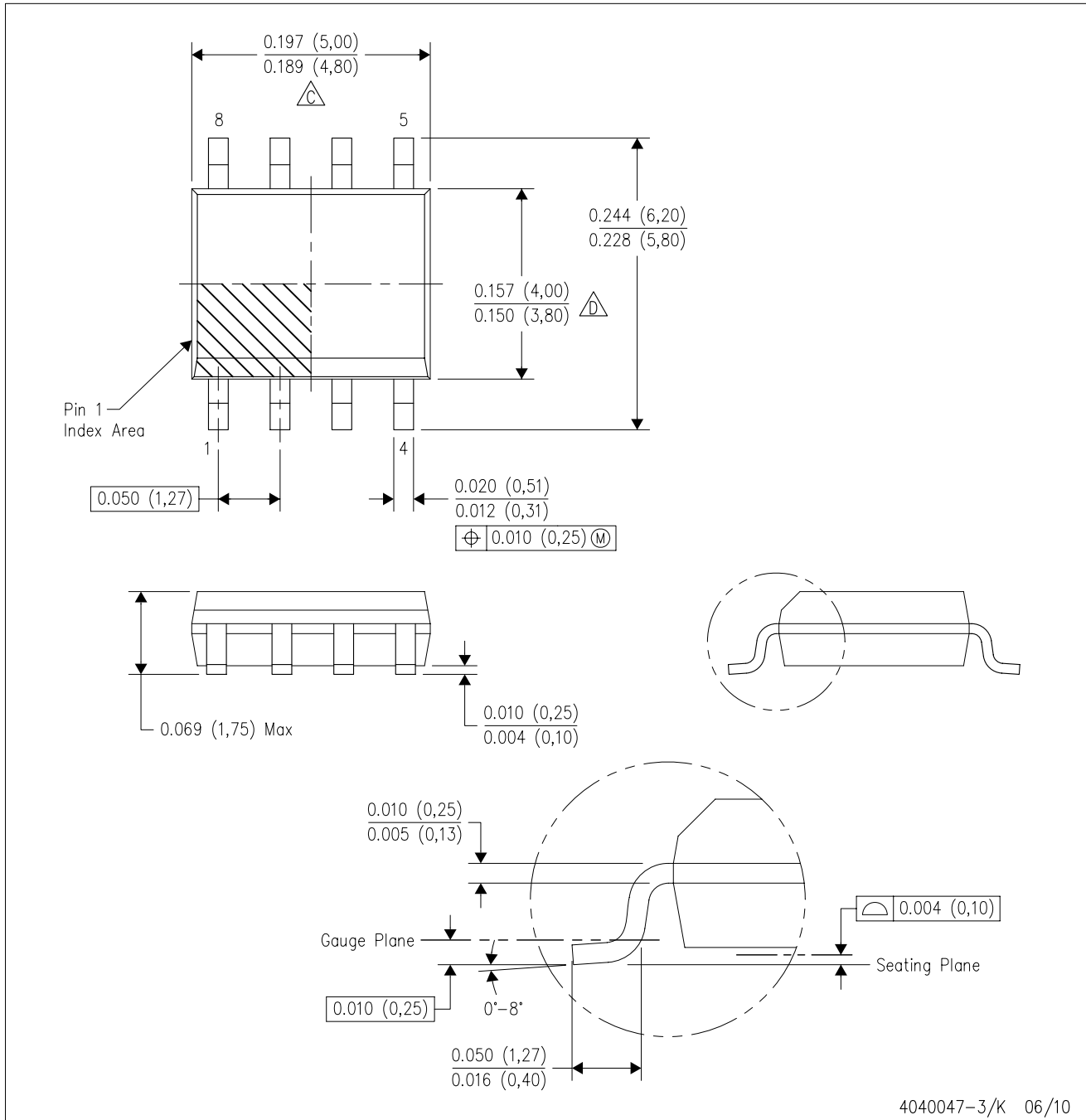

NOTES: A. All linear dimensions are in inches (millimeters).
 B. This drawing is subject to change without notice.
 C. Body length does not include mold flash, protrusions, or gate burrs. Mold flash, protrusions, or gate burrs shall not exceed .006 (0,15) per end.
 D. Body width does not include interlead flash. Interlead flash shall not exceed .017 (0,43) per side.
 E. Reference JEDEC MS-012 variation AA.

D (R-PDSO-G8)

PLASTIC SMALL OUTLINE

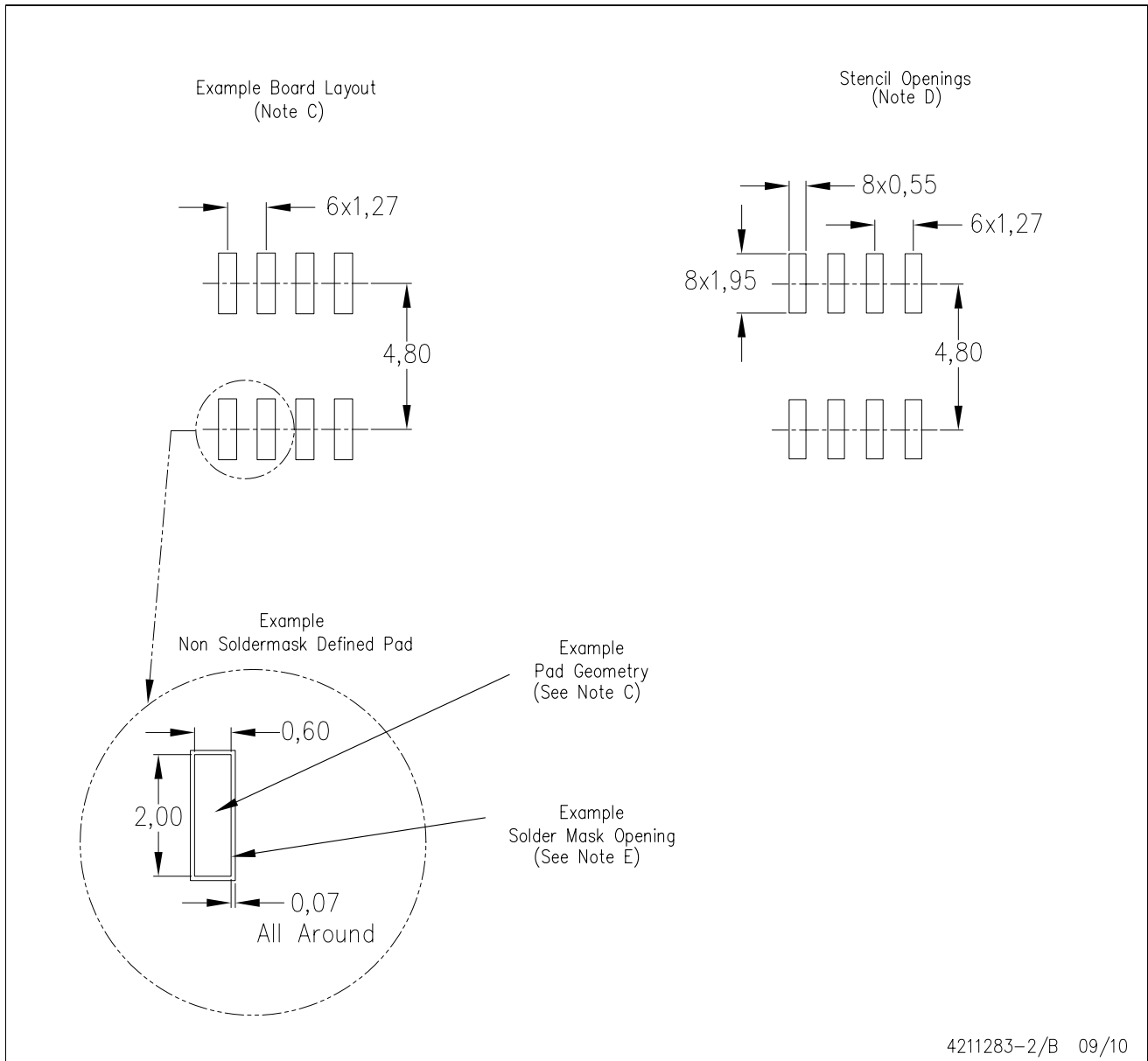

- NOTES:
- All linear dimensions are in millimeters.
 - This drawing is subject to change without notice.
 - Publication IPC-7351 is recommended for alternate designs.
 - Laser cutting apertures with trapezoidal walls and also rounding corners will offer better paste release. Customers should contact their board assembly site for stencil design recommendations. Refer to IPC-7525 for other stencil recommendations.
 - Customers should contact their board fabrication site for solder mask tolerances between and around signal pads.

PW (R-PDSO-G**)

PLASTIC SMALL-OUTLINE PACKAGE

14 PINS SHOWN

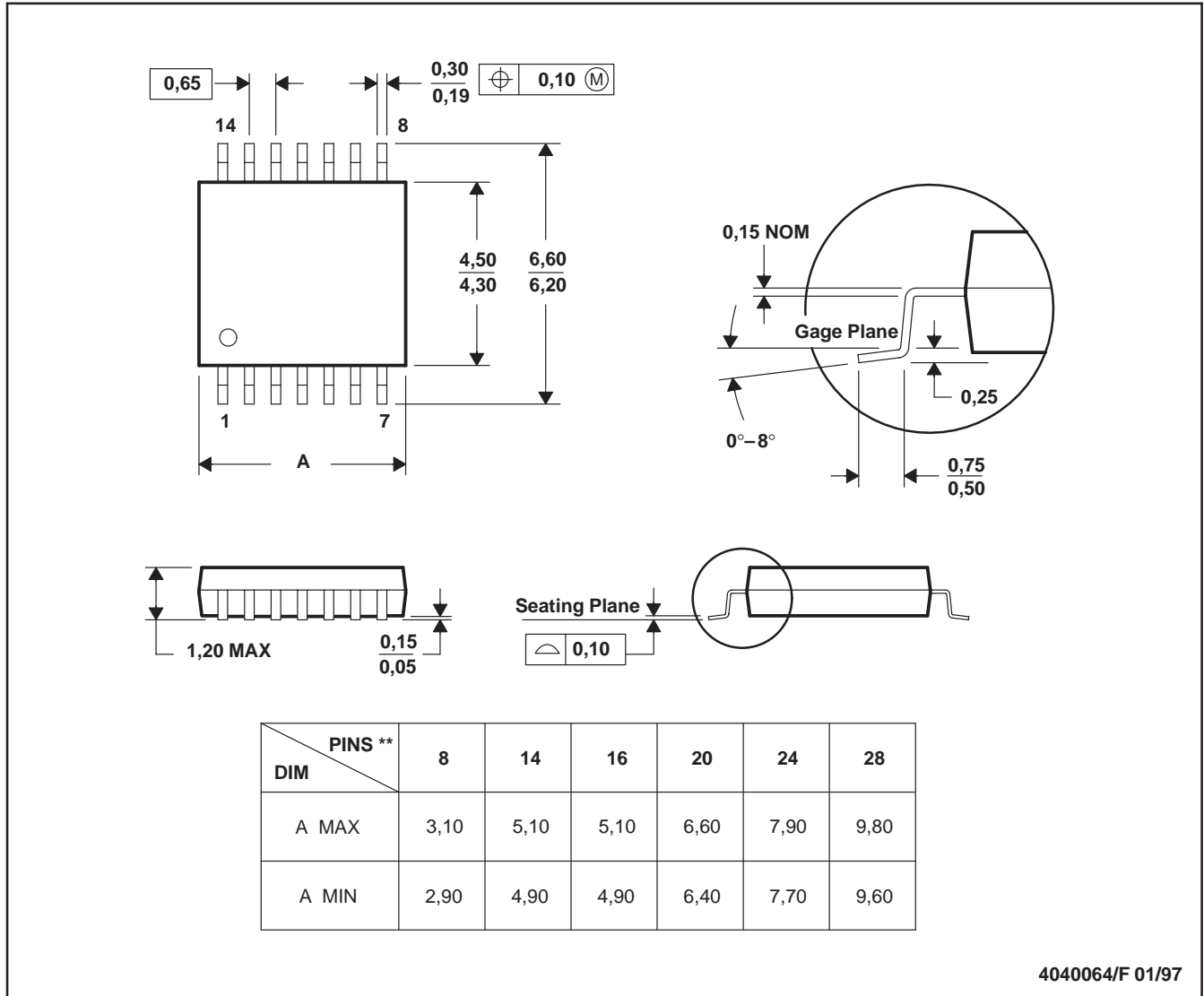

4040064/F 01/97

- NOTES: A. All linear dimensions are in millimeters.
 B. This drawing is subject to change without notice.
 C. Body dimensions do not include mold flash or protrusion not to exceed 0,15.
 D. Falls within JEDEC MO-153

PW (R-PDSO-G14)

PLASTIC SMALL OUTLINE

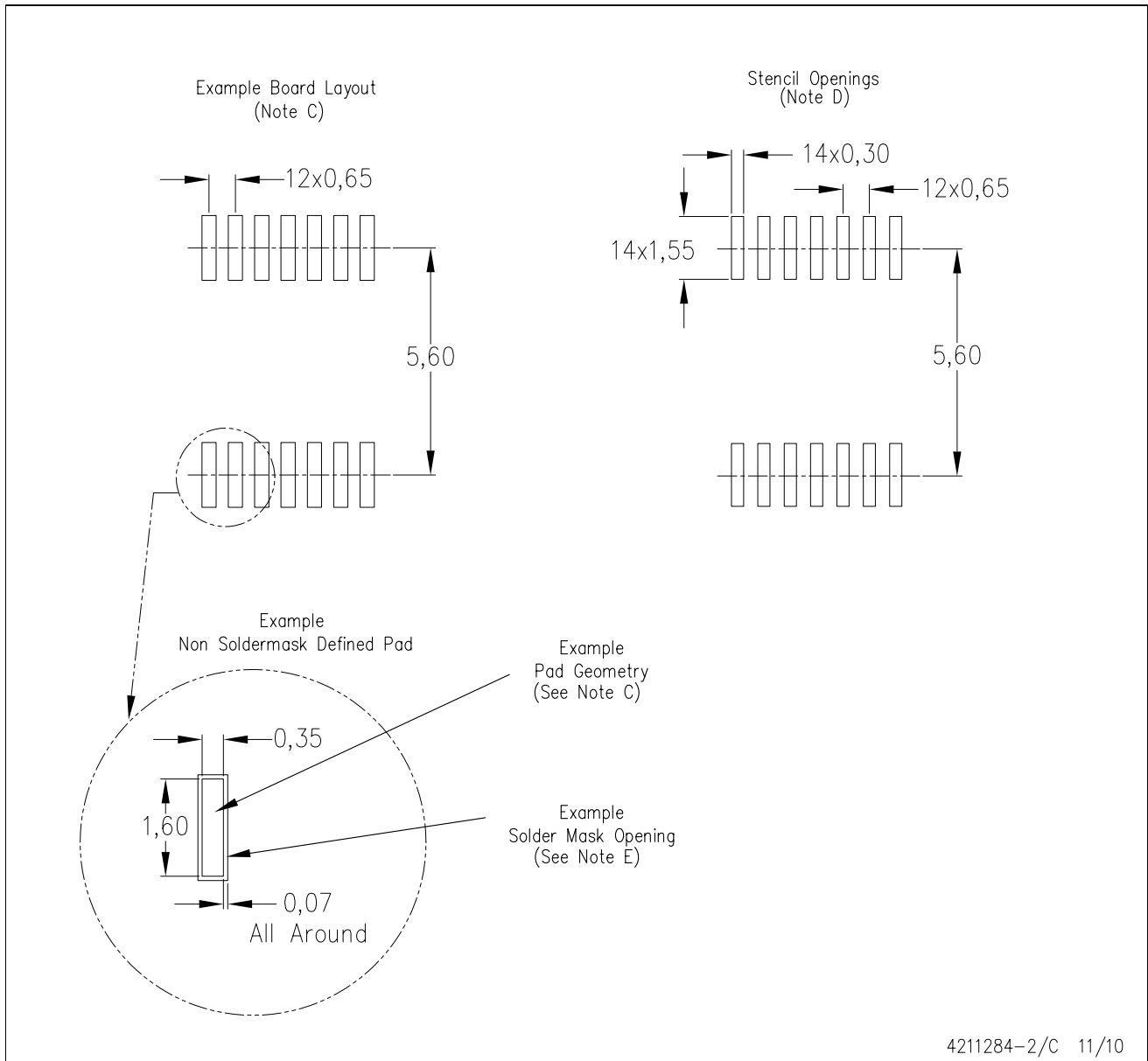

- NOTES:
- All linear dimensions are in millimeters.
 - This drawing is subject to change without notice.
 - Publication IPC-7351 is recommended for alternate designs.
 - Laser cutting apertures with trapezoidal walls and also rounding corners will offer better paste release. Customers should contact their board assembly site for stencil design recommendations. Refer to IPC-7525 for other stencil recommendations.
 - Customers should contact their board fabrication site for solder mask tolerances between and around signal pads.

PW (R-PDSO-G16)

PLASTIC SMALL OUTLINE

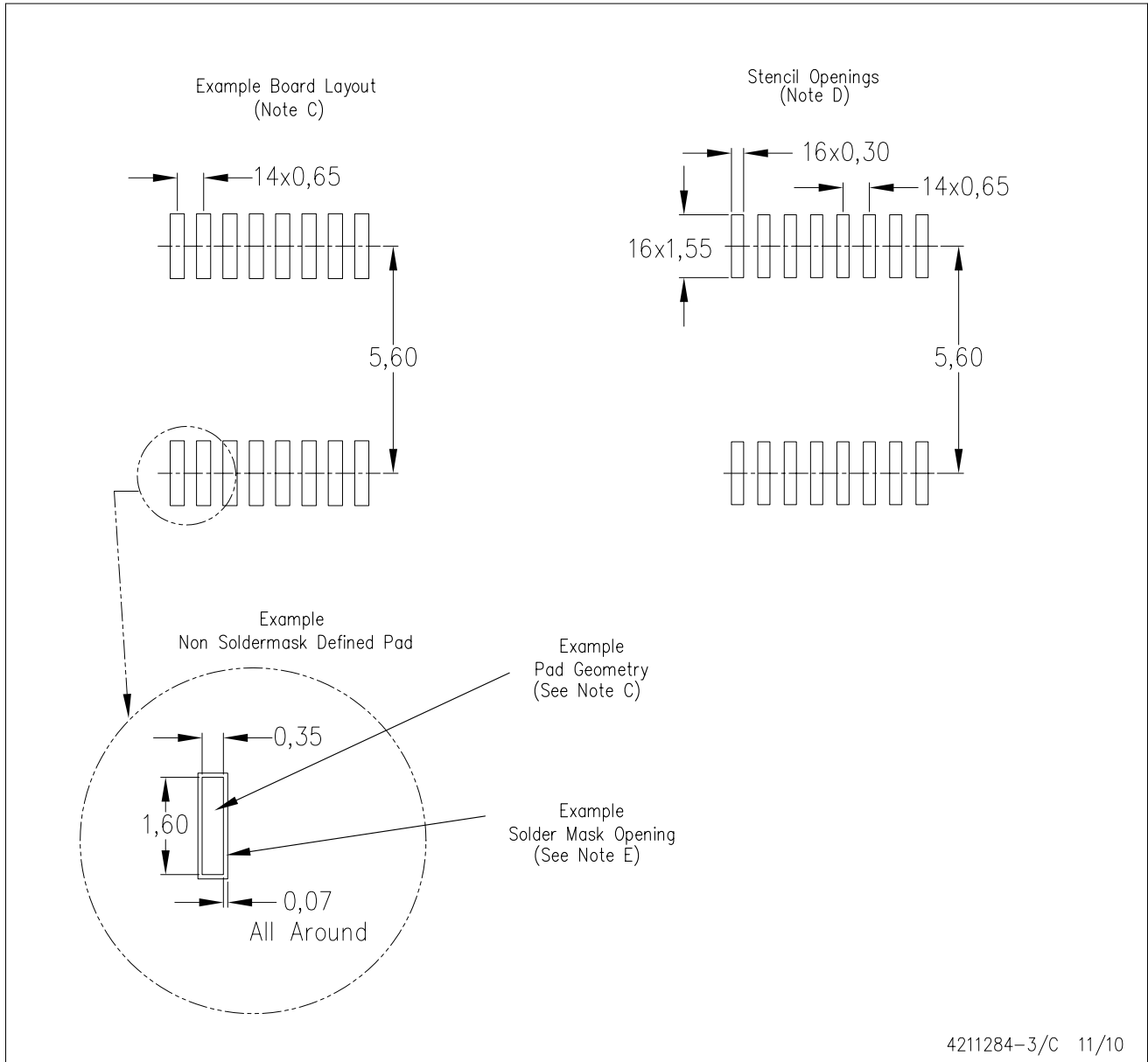

- NOTES:
- All linear dimensions are in millimeters.
 - This drawing is subject to change without notice.
 - Publication IPC-7351 is recommended for alternate designs.
 - Laser cutting apertures with trapezoidal walls and also rounding corners will offer better paste release. Customers should contact their board assembly site for stencil design recommendations. Refer to IPC-7525 for other stencil recommendations.
 - Customers should contact their board fabrication site for solder mask tolerances between and around signal pads.

IMPORTANT NOTICE

Texas Instruments Incorporated and its subsidiaries (TI) reserve the right to make corrections, modifications, enhancements, improvements, and other changes to its products and services at any time and to discontinue any product or service without notice. Customers should obtain the latest relevant information before placing orders and should verify that such information is current and complete. All products are sold subject to TI's terms and conditions of sale supplied at the time of order acknowledgment.

TI warrants performance of its hardware products to the specifications applicable at the time of sale in accordance with TI's standard warranty. Testing and other quality control techniques are used to the extent TI deems necessary to support this warranty. Except where mandated by government requirements, testing of all parameters of each product is not necessarily performed.

TI assumes no liability for applications assistance or customer product design. Customers are responsible for their products and applications using TI components. To minimize the risks associated with customer products and applications, customers should provide adequate design and operating safeguards.

TI does not warrant or represent that any license, either express or implied, is granted under any TI patent right, copyright, mask work right, or other TI intellectual property right relating to any combination, machine, or process in which TI products or services are used. Information published by TI regarding third-party products or services does not constitute a license from TI to use such products or services or a warranty or endorsement thereof. Use of such information may require a license from a third party under the patents or other intellectual property of the third party, or a license from TI under the patents or other intellectual property of TI.

Reproduction of TI information in TI data books or data sheets is permissible only if reproduction is without alteration and is accompanied by all associated warranties, conditions, limitations, and notices. Reproduction of this information with alteration is an unfair and deceptive business practice. TI is not responsible or liable for such altered documentation. Information of third parties may be subject to additional restrictions.

Resale of TI products or services with statements different from or beyond the parameters stated by TI for that product or service voids all express and any implied warranties for the associated TI product or service and is an unfair and deceptive business practice. TI is not responsible or liable for any such statements.

TI products are not authorized for use in safety-critical applications (such as life support) where a failure of the TI product would reasonably be expected to cause severe personal injury or death, unless officers of the parties have executed an agreement specifically governing such use. Buyers represent that they have all necessary expertise in the safety and regulatory ramifications of their applications, and acknowledge and agree that they are solely responsible for all legal, regulatory and safety-related requirements concerning their products and any use of TI products in such safety-critical applications, notwithstanding any applications-related information or support that may be provided by TI. Further, Buyers must fully indemnify TI and its representatives against any damages arising out of the use of TI products in such safety-critical applications.

TI products are neither designed nor intended for use in military/aerospace applications or environments unless the TI products are specifically designated by TI as military-grade or "enhanced plastic." Only products designated by TI as military-grade meet military specifications. Buyers acknowledge and agree that any such use of TI products which TI has not designated as military-grade is solely at the Buyer's risk, and that they are solely responsible for compliance with all legal and regulatory requirements in connection with such use.

TI products are neither designed nor intended for use in automotive applications or environments unless the specific TI products are designated by TI as compliant with ISO/TS 16949 requirements. Buyers acknowledge and agree that, if they use any non-designated products in automotive applications, TI will not be responsible for any failure to meet such requirements.

Following are URLs where you can obtain information on other Texas Instruments products and application solutions:

Products		Applications	
Amplifiers	amplifier.ti.com	Audio	www.ti.com/audio
Data Converters	dataconverter.ti.com	Automotive	www.ti.com/automotive
DLP® Products	www.dlp.com	Communications and Telecom	www.ti.com/communications
DSP	dsp.ti.com	Computers and Peripherals	www.ti.com/computers
Clocks and Timers	www.ti.com/clocks	Consumer Electronics	www.ti.com/consumer-apps
Interface	interface.ti.com	Energy	www.ti.com/energy
Logic	logic.ti.com	Industrial	www.ti.com/industrial
Power Mgmt	power.ti.com	Medical	www.ti.com/medical
Microcontrollers	microcontroller.ti.com	Security	www.ti.com/security
RFID	www.ti-rfid.com	Space, Avionics & Defense	www.ti.com/space-avionics-defense
RF/IF and ZigBee® Solutions	www.ti.com/lprf	Video and Imaging	www.ti.com/video
		Wireless	www.ti.com/wireless-apps