

VOLTAGE-CONTROLLED CRYSTAL OSCILLATOR (VCXO) 10 MHz TO 1.4 GHz

Features

- Available with any-rate output frequencies from 10 MHz to 945 MHz and selected frequencies to 1.4 GHz
- 3rd generation DSPLL[®] with superior jitter performance
- 3x better frequency stability than SAW based oscillators
- Internal fixed crystal frequency ensures high reliability and low aging
- Available CMOS, LVPECL, LVDS, & CML outputs
- 3.3, 2.5, and 1.8 V supply options
- Industry-standard 5 x 7 mm package and pinout
- Lead-free/RoHS-compliant

Applications

- SONET / SDH
- xDSL
- 10 GbE LAN / WAN
- Low-jitter clock generation
- Optical modules
- Clock and data recovery

Description

The Si550 VCXO utilizes Silicon Laboratories' advanced DSPLL[®] circuitry to provide a low-jitter clock at high frequencies. The Si550 is available with any-rate output frequency from 10 to 945 MHz and selected frequencies to 1400 MHz. Unlike traditional VCXO's where a different crystal is required for each output frequency, the Si550 uses one fixed crystal to provide a wide range of output frequencies. This IC based approach allows the crystal resonator to provide exceptional frequency stability and reliability. In addition, DSPLL clock synthesis provides superior supply noise rejection, simplifying the task of generating low-jitter clocks in noisy environments typically found in communication systems. The Si550 IC-based VCXO is factory configurable for a wide variety of user specifications, including frequency, supply voltage, output format, tuning slope, and temperature stability. Specific configurations are factory programmed at time of shipment, thereby eliminating long lead times associated with custom oscillators.

Functional Block Diagram

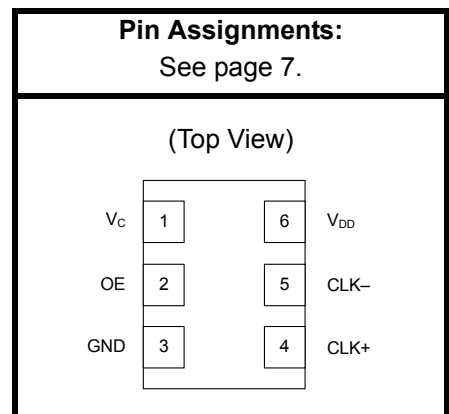
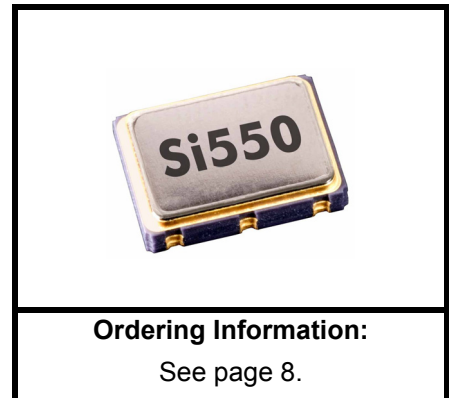
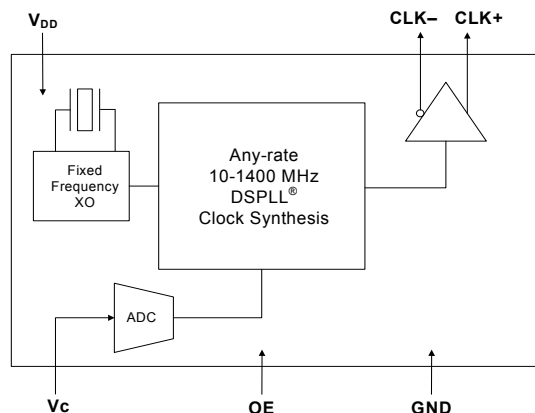

Si550

[查询"Si550"供应商](#)

1. Electrical Specifications

Table 1. Recommended Operating Conditions

Parameter	Symbol	Test Condition	Min	Typ	Max	Units
Supply Voltage ¹	V _{DD}	3.3 V option	2.97	3.3	3.63	V
		2.5 V option	2.25	2.5	2.75	
		1.8 V option	1.71	1.8	1.89	
Supply Current	I _{DD}	Output enabled	—	90	—	mA
		TriState mode	—	60	—	
Output Enable (OE) ²		V _{IH} ²	0.75 x V _{DD}	—	—	V
		V _{IL}	—	—	0.5	
Operating Temperature Range	T _A		−40	—	85	°C

Notes:

1. Selectable parameter specified by part number. See Section 3. "Ordering Information" on page 8 for further details.
2. OE pin includes a 17 kΩ pullup resistor to VDD. Pulling OE to ground causes outputs to tristate.

Table 2. V_C Control Voltage Input

Parameter	Symbol	Test Condition	Min	Typ	Max	Units
Control Voltage Tuning Slope ^{1,2,3}	K _V	10 to 90% of V _{DD}	—	45 90 135 180	—	ppm/V
Control Voltage Linearity ⁴	L _{VC}	BSL	−5	±1	+5	%
		Incremental	−10	±5	+10	
Modulation Bandwidth	BW		9.3	10.0	10.7	kHz
V _C Input Impedance	Z _{VC}		500	—	—	kΩ
Nominal Control Voltage	V _{CNOM}	@ f _O	—	3/8 x V _{DD}	—	V
Control Voltage Tuning Range	V _C		0		V _{DD}	V

Notes:

1. Positive slope; selectable option by part number. See Section 3. "Ordering Information" on page 8.
2. For best jitter and phase noise performance, always choose the smallest K_V that meets the application's minimum APR requirements. See "AN266: VCXO Tuning Slope (K_V), Stability, and Absolute Pull Range (APR)" for more information.
3. K_V variation is ±28% of typical values.
4. BSL determined from deviation from best straight line fit with V_C ranging from 10 to 90% of V_{DD}. Incremental slope determined with V_C ranging from 10 to 90% of V_{DD}.

[查询"Si550"供应商](#)

Table 3. CLK± Output Frequency Characteristics

Parameter	Symbol	Test Condition	Min	Typ	Max	Units
Nominal Frequency ^{1,2,3}	f_O	LVDS/CML/LVPECL	10	—	945	MHz
		CMOS	10	—	160	
Temperature Stability ^{1,4}	$\Delta f/f_O$	$T_A = -40$ to $+85$ °C	-20 -50 -100	— — —	+20 +50 +100	ppm
Absolute Pull Range ^{1,4}	APR		±25	—	±150	ppm
Aging		Frequency drift over 15 year life.	—	—	±10	ppm
Power up Time ⁵	t_{OSC}		—	—	10	ms

Notes:

1. See Section 3. "Ordering Information" on page 8 for further details.
2. Specified at time of order by part number. Also available in frequencies from 970 to 1134 MHz and 1213 to 1417 MHz.
3. Nominal output frequency set by $V_{CNOM} = 3/8 \times V_{DD}$.
4. Selectable parameter specified by part number.
5. Time from power up or tristate mode to f_O .

Table 4. CLK± Output Levels and Symmetry

Parameter	Symbol	Test Condition	Min	Typ	Max	Units
LVPECL Output Option ¹	V_O	mid-level	$V_{DD} - 1.42$	—	$V_{DD} - 1.25$	V
	V_{OD}	swing (diff)	1.1	—	1.9	V_{PP}
	V_{SE}	swing (single-ended)	0.5	—	0.93	V_{PP}
LVDS Output Option ²	V_O	mid-level	1.125	1.20	1.275	V
	V_{OD}	swing (diff)	0.32	0.40	0.50	V_{PP}
CML Output Option ²	V_O	mid-level	—	$V_{DD} - 0.75$	—	V
	V_{OD}	swing (diff)	0.70	0.95	1.20	V_{PP}
CMOS Output Option ³	V_{OH}	$I_{OH} = 32$ mA	$0.8 \times V_{DD}$	—	V_{DD}	V
	V_{OL}	$I_{OL} = 32$ mA	—	—	0.4	
Rise/Fall time (20/80%)	t_R, t_F	LVPECL/LVDS/CML	—	—	350	ps
		CMOS with CL = 15 pF	—	1	—	ns

Si550

[查询"Si550"供应商](#)

Table 4. CLK± Output Levels and Symmetry (Continued)

Parameter	Symbol	Test Condition	Min	Typ	Max	Units
Symmetry (duty cycle)	SYM	LVPECL: $V_{DD} - 1.3$ V (diff) LVDS: 1.25 V (diff) CMOS: $V_{DD}/2$	45	—	55	%

Notes:

1. 50Ω to $V_{DD} - 2.0$ V.
2. $R_{term} = 100 \Omega$ (differential).
3. $C_L = 15$ pF

Table 5. CLK± Output Phase Jitter

Parameter	Symbol	Test Condition	Min	Typ	Max	Units
Phase Jitter (RMS) ^{1,2,3} for $F_{OUT} \geq 500$ MHz	ϕ_J	Kv = 45 ppm/V 12 kHz to 20 MHz (OC-48) 50 kHz to 80 MHz (OC-192)	—	0.35	—	ps
		Kv = 90 ppm/V 12 kHz to 20 MHz (OC-48) 50 kHz to 80 MHz (OC-192)	—	0.41	—	
		Kv = 135 ppm/V 12 kHz to 20 MHz (OC-48) 50 kHz to 80 MHz (OC-192)	—	0.46	—	
		Kv = 180 ppm/V 12 kHz to 20 MHz (OC-48) 50 kHz to 80 MHz (OC-192)	—	0.52	—	
Phase Jitter (RMS) ^{1,2,3} for F_{OUT} of 125 to 500 MHz	ϕ_J	Kv = 45 ppm/V 12 kHz to 20 MHz (OC-48) 50 kHz to 80 MHz (OC-192)	—	0.42	—	ps
		Kv = 90 ppm/V 12 kHz to 20 MHz (OC-48) 50 kHz to 80 MHz (OC-192)	—	0.60	—	
		Kv = 135 ppm/V 12 kHz to 20 MHz (OC-48) 50 kHz to 80 MHz (OC-192)	—	0.64	—	
		Kv = 180 ppm/V 12 kHz to 20 MHz (OC-48) 50 kHz to 80 MHz (OC-192)	—	0.68	—	

Notes:

1. Differential Modes: LVPECL/LVDS/CML. Refer to AN255, AN256, and AN266 for further information.
2. For best jitter and phase noise performance, always choose the smallest K_V that meets the application's minimum APR requirements. See "AN266: VCXO Tuning Slope (K_V), Stability, and Absolute Pull Range (APR)" for more information.
3. See "AN255: Replacing 622 MHz VCXO devices with the Si550 VCXO" for comparison highlighting power supply rejection (PSR) advantage of Si55x versus SAW-based solutions.

[查询"Si550"供应商](#)

Table 6. CLK± Output Period Jitter

Parameter	Symbol	Test Condition	Min	Typ	Max	Units
Period Jitter* for $F_{OUT} \leq 160$ MHz	J_{PER}	RMS	—	2	—	ps
		Peak-to-Peak	—	14	—	

***Note:** Any output mode, including CMOS, LVPECL, LVDS, CML. N = 1000 cycles.

Table 7. CLK± Output Phase Noise (Typical)

Configuration	f_C K_V Output	74.25 MHz 45 ppm/V CMOS	300 MHz 90 ppm/V LVPECL	622.08 MHz 45 ppm/V LVPECL	Units
Offset Frequency (f)	$\mathcal{L}(f)$				dBc/Hz
100 Hz		-94	-74	-77	
1 kHz		-117	-98	-101	
10 kHz		-128	-112	-114	
100 kHz		-135	-122	-118	
1 MHz		-138	-134	-128	
10 MHz		-143	-144	-144	
100 MHz		n/a	-147	-147	

Si550

[查询"Si550"供应商](#)

Table 8. Absolute Maximum Ratings

Parameter	Symbol	Rating	Units
Supply Voltage	V_{DD}	-0.5 to +3.8	Volts
Input Voltage	V_I	-0.5 to $V_{DD} + 0.3$	Volts
Storage Temperature	T_S	-55 to +125	°C
ESD Sensitivity (HBM, per JESD22-A114)	ESD	>2500	Volts
Soldering Temperature (lead-free profile)	T_{PEAK}	260	°C
Soldering Temperature Time @ T_{PEAK} (lead-free profile)	t_p	10	seconds

Note: Stresses beyond those listed in Absolute Maximum Ratings may cause permanent damage to the device. Functional operation or specification compliance is not implied at these conditions.

Table 9. Environmental Compliance

The Si550 meets the following qualification test requirements.

Parameter	Conditions/ Test Method
Mechanical Shock	MIL-STD-883F, Method 2002.3 B
Mechanical Vibration	MIL-STD-883F, Method 2007.3 A
Solderability	MIL-STD-883F, Method 203.8
Gross & Fine Leak	MIL-STD-883F, Method 1014.7
Resistance to Solvents	MIL-STD-883F, Method 2016

[查询"Si550"供应商](#)

2. Pin Descriptions

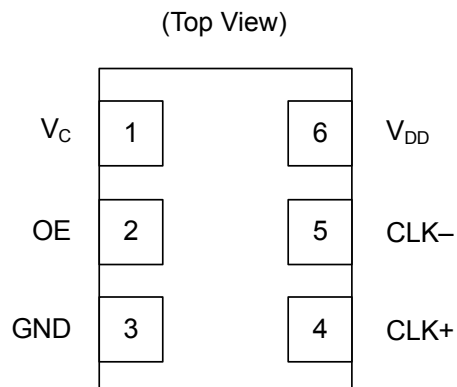

Table 10. Si550 Pin Descriptions

Pin	Name	Type	Function
1	V_C	Analog Input	Control Voltage
2	OE*	Input	Output Enable: 0 = clock output disabled (outputs tri-stated) 1 = clock output enabled
3	GND	Ground	Electrical and Case Ground
4	CLK+	Output	Oscillator Output
5	CLK– (N/A for CMOS)	Output	Complementary Output (N/C for CMOS)
6	V_{DD}	Power	Power Supply Voltage

***Note:** OE includes 17 k Ω pullup resistor to V_{DD} .

Si550

[查询"Si550"供应商](#)

3. Ordering Information

The Si550 was designed to support a variety of options including frequency, temperature stability, tuning slope, output format, and V_{DD} . Specific device configurations are programmed into the Si550 at time of shipment. Configurations are specified using the Part Number Configuration chart shown below. Silicon Labs provides a web browser-based part number configuration utility to simplify this process. Refer to www.silabs.com/VCXOPartNumber to access this tool and for further ordering instructions. The Si550 VCXO series is supplied in an industry-standard, RoHS compliant, lead-free, 6-pad, 5 x 7 mm package. Tape and reel packaging is an ordering option.

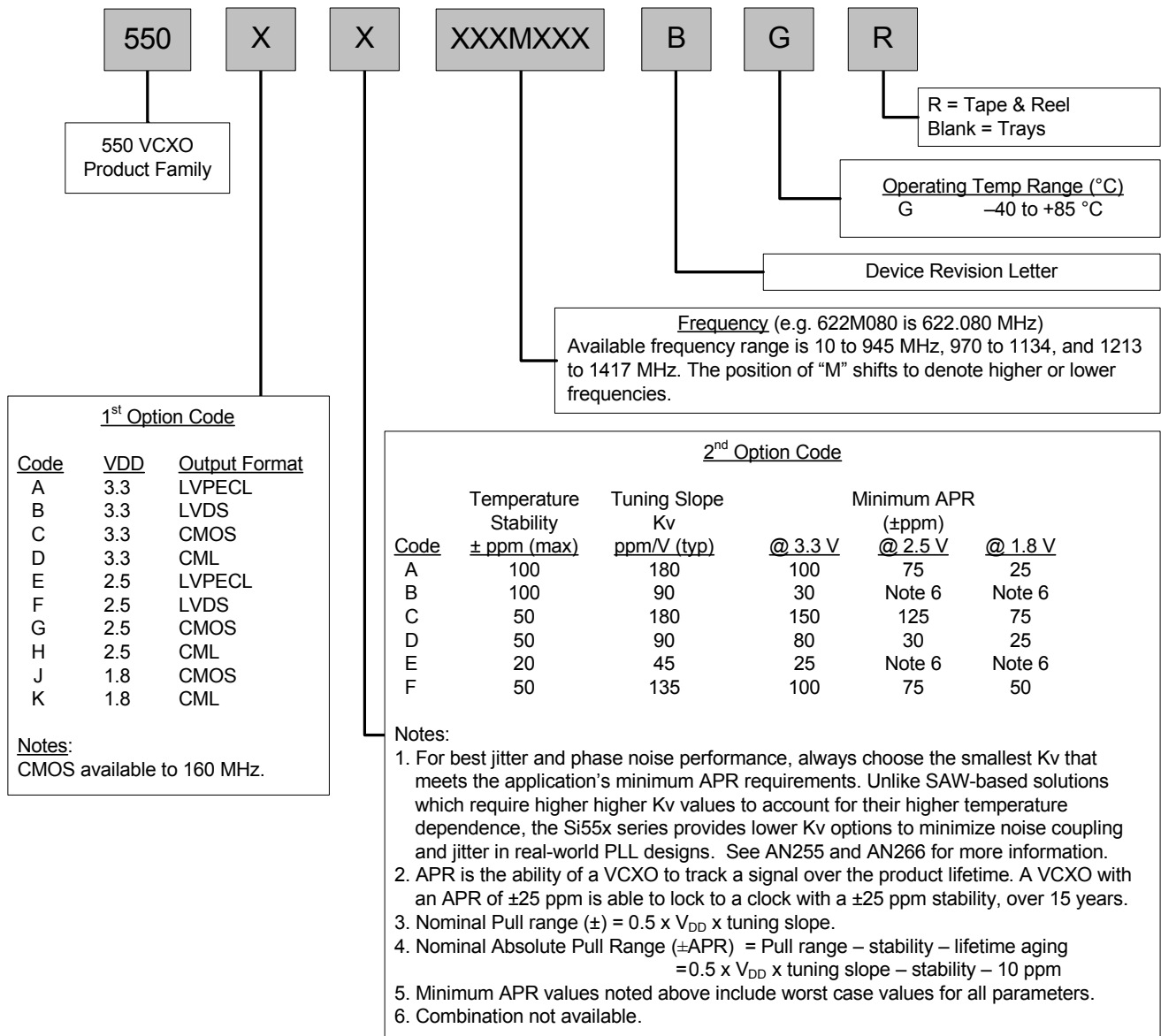

Example Part Number: 550AF622M080BGR is a 5 x 7 mm VCXO in a 6 pad package. The nominal frequency is 622.080 MHz, with a 3.3 V supply and LVPECL output. Temperature stability is specified as ±50 ppm and the tuning slope is 135 ppm/V. The part is specified for a -40 to +85 °C ambient temperature range operation and is shipped in tape and reel format.

[查询"Si550"供应商](#)

4. Outline Diagram and Suggested Pad Layout

Figure 1 illustrates the package details for the Si550. Table 11 lists the values for the dimensions shown in the illustration.

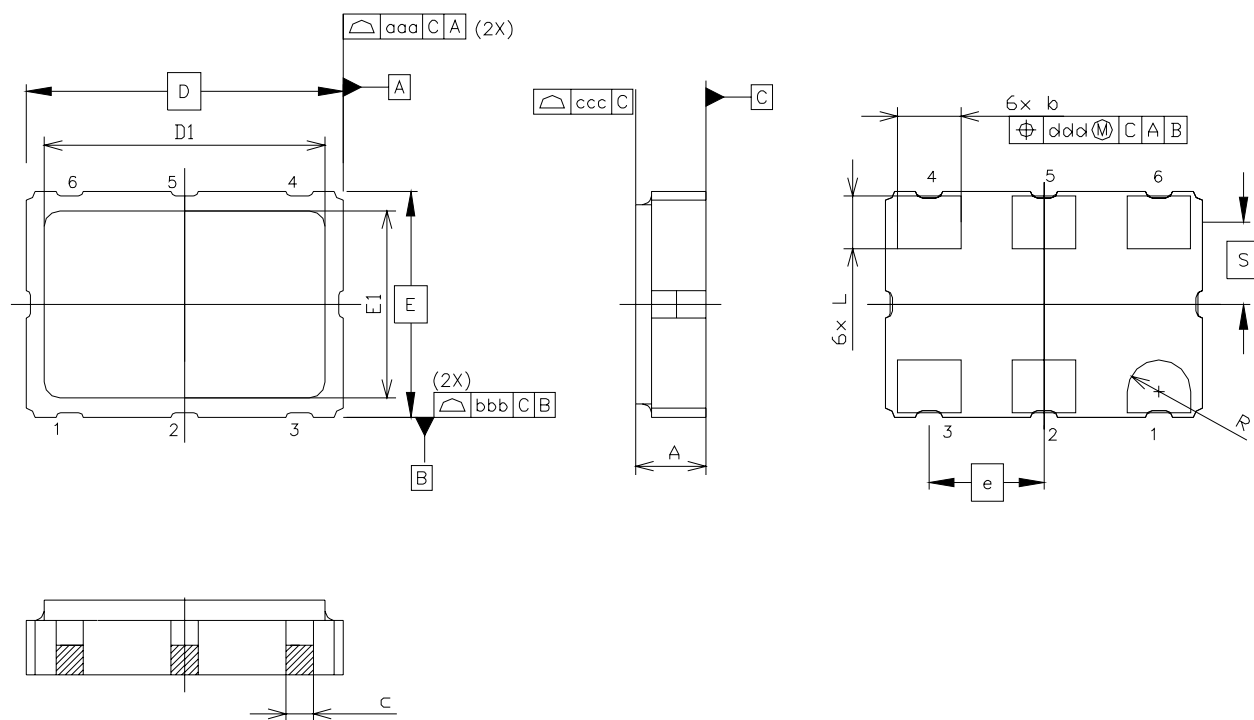

Figure 1. Si550 Outline Diagram

Table 11. Package Diagram Dimensions (mm)

Dimension	Min	Nom	Max
A	1.45	1.65	1.85
b	1.2	1.4	1.6
c	0.60 TYP.		
D	7.00 BSC.		
D1	6.10	6.2	6.30
e	2.54 BSC.		
E	5.00 BSC.		
E1	4.30	4.40	4.50
L	1.07	1.27	1.47
S	1.815 BSC.		
R	0.7 REF.		
aaa	—	—	0.15
bbb	—	—	0.15
ccc	—	—	0.10
ddd	—	—	0.10

5. 6-Pin PCB Land Pattern

Figure 2 illustrates the 6-pin PCB land pattern for the Si550. Table 12 lists the values for the dimensions shown in the illustration.

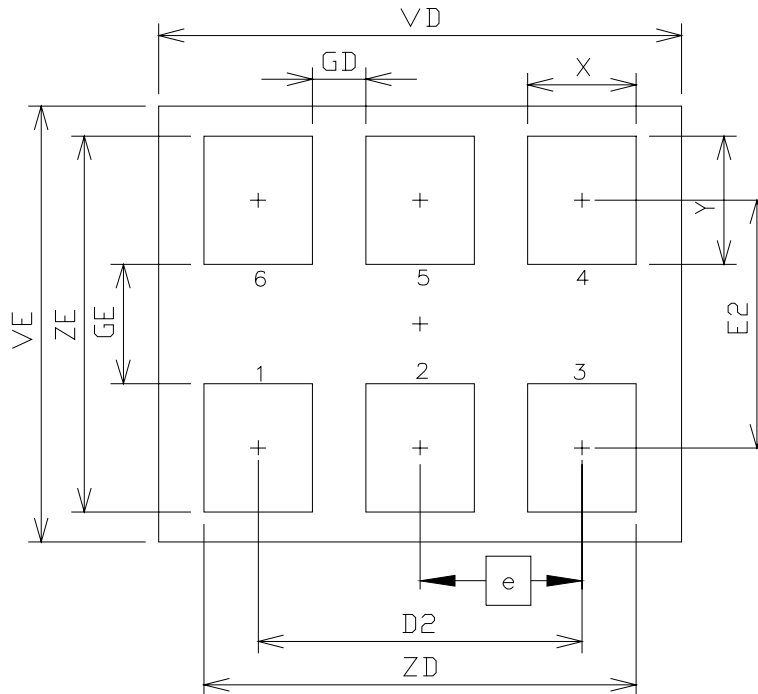

Figure 2. Si550 PCB Land Pattern

Table 12. PCB Land Pattern Dimensions (mm)

Dimension	Min	Max
D2		5.08 REF
e		2.54 BSC
E2		4.15 REF
GD	0.84	—
GE	2.00	—
VD		8.20 REF
VE		7.30 REF
X		1.70 TYP
Y		2.15 REF
ZD	—	6.78
ZE	—	6.30

Notes:

1. Dimensioning and tolerancing per the ANSI Y14.5M-1994 specification.
2. Land pattern design based on IPC-7351 guidelines.
3. All dimensions shown are at maximum material condition (MMC).
4. Controlling dimension is in millimeters (mm).

[查询"SI550"供应商](#)

DOCUMENT CHANGE LIST

Revision 0.2 to Revision 0.3

- Updated 1. "Electrical Specifications" on page 2.
 - Updated ordering and format of Table 1 through Table 9.
 - Updated LVDS and CML in Table 4, "CLK± Output Levels and Symmetry," on page 3.
 - Updated RMS jitter values in Table 5, "CLK± Output Phase Jitter," on page 4.
 - Added Typical Phase Noise performance data in Table 5, "CLK± Output Phase Jitter," on page 4.
- Updated 3. "Ordering Information" on page 8.
 - Removed ordering option E at $V_{DD} = 2.5\text{ V}$ in table for the 2nd Option Code.
 - Typical APRs replaced with minimum APR values.
 - New 135 ppm/V K_V option included.



Si550

[查询"SI550"供应商](#)

CONTACT INFORMATION

Silicon Laboratories Inc.

4635 Boston Lane
Austin, TX 78735
Tel: 1+(512) 416-8500
Fax: 1+(512) 416-9669
Toll Free: 1+(877) 444-3032
Email: VCXOinfo@silabs.com
Internet: www.silabs.com

The information in this document is believed to be accurate in all respects at the time of publication but is subject to change without notice. Silicon Laboratories assumes no responsibility for errors and omissions, and disclaims responsibility for any consequences resulting from the use of information included herein. Additionally, Silicon Laboratories assumes no responsibility for the functioning of undescribed features or parameters. Silicon Laboratories reserves the right to make changes without further notice. Silicon Laboratories makes no warranty, representation or guarantee regarding the suitability of its products for any particular purpose, nor does Silicon Laboratories assume any liability arising out of the application or use of any product or circuit, and specifically disclaims any and all liability, including without limitation consequential or incidental damages. Silicon Laboratories products are not designed, intended, or authorized for use in applications intended to support or sustain life, or for any other application in which the failure of the Silicon Laboratories product could create a situation where personal injury or death may occur. Should Buyer purchase or use Silicon Laboratories products for any such unintended or unauthorized application, Buyer shall indemnify and hold Silicon Laboratories harmless against all claims and damages.

Silicon Laboratories, Silicon Labs, and DSPLL are trademarks of Silicon Laboratories Inc.
Other products or brandnames mentioned herein are trademarks or registered trademarks of their respective holders.