

**390-002**  
**Submersible EMI/RFI Cable Sealing Backshell**  
 with Strain Relief  
 Type A - Direct Coupling - Low Profile

**CONNECTOR DESIGNATORS**  
**A-B\*-C-D-E-F**  
**G-H-J-K-L-S**

\* Conn. Desig. B See Note 5  
**DIRECT COUPLING**

**TYPE A OVERALL SHIELD TERMINATION**

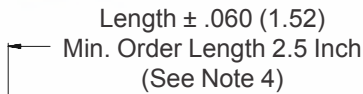
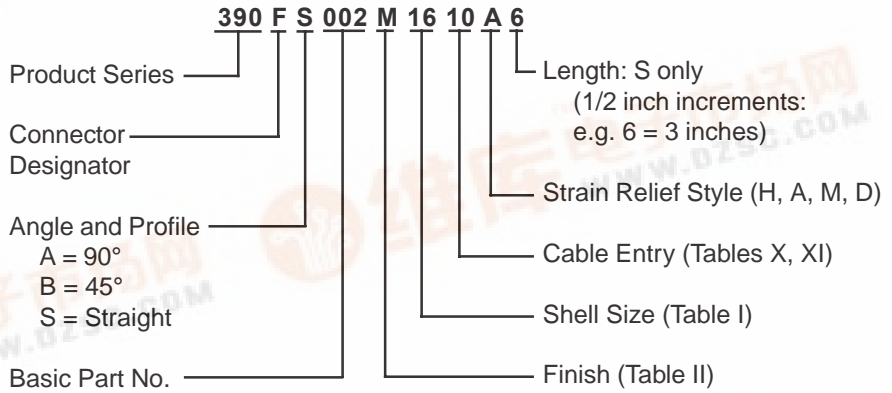

**STYLE 2**  
 (STRAIGHT  
 See Note 1)

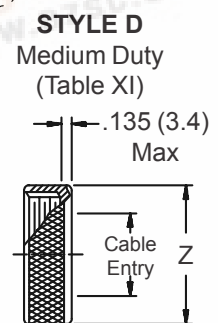
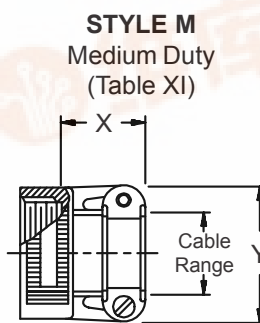
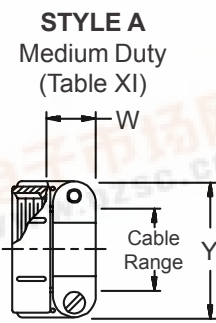
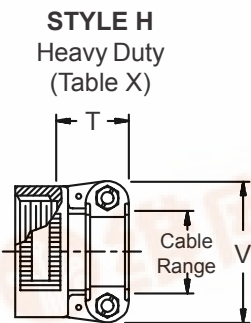
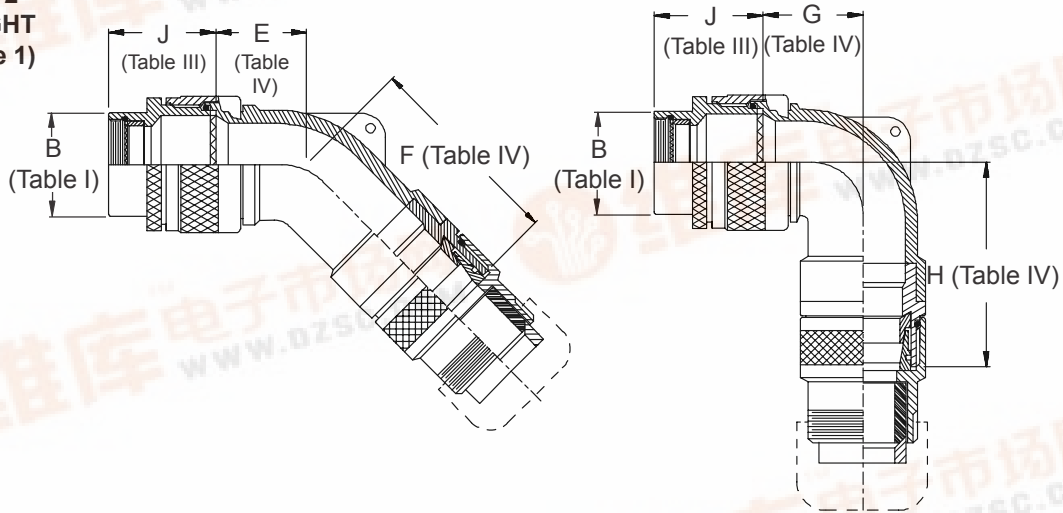
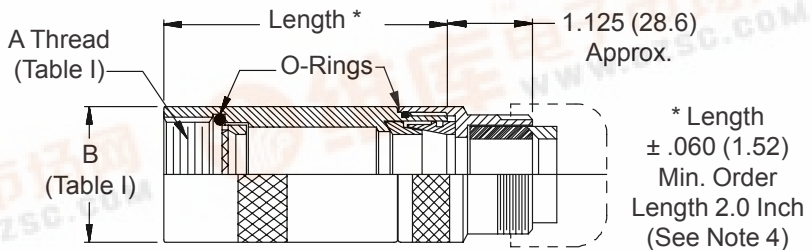

**Submersible EMI/RFI Cable Sealing Backshell**  
with Strain Relief  
Type A - Direct Coupling - Low Profile



See inside back cover fold-out or pages 13 and 14 for Tables I and II.

TABLE III: FRONT ADAPTER			
Shell Size	J Max - Conn. Designator		
	A-E-F		
	J-H-L-S	D-B-G-K	C
08/09	1.180(30.0)	1.250(31.8)	
10/11	1.180(30.0)	1.250(31.8)	
12/13	1.180(30.0)	1.250(31.8)	1.735(44.1)
14/15	1.180(30.0)	1.250(31.8)	1.915(48.6)
16/17	1.380(35.0)	1.560(39.6)	1.915(48.6)
18/19	1.380(35.0)	1.560(39.6)	1.915(48.6)
20/21	1.380(35.0)	1.560(39.6)	1.915(48.6)
22/23	1.380(35.0)	1.560(39.6)	1.915(48.6)
24/25	1.380(35.0)	1.560(39.6)	1.915(48.6)
28/29	1.610(40.9)	1.560(39.6)	1.915(48.6)
32/33	1.610(40.9)	1.750(44.5)	1.915(48.6)
36	1.610(40.9)	1.750(44.5)	1.915(48.6)
40	1.610(40.9)	2.190(55.6)	1.915(48.6)

TABLE IV: ELBOW DIMENSIONS								
Dash No.	E		F		G		H	
	Max		Max		Max		Max	
04	.630	(16.0)	2.117	(53.8)	.636	(16.2)	2.067	(52.5)
06	.630	(16.0)	2.117	(53.8)	.710	(18.0)	2.187	(55.5)
08	.692	(17.6)	2.179	(55.3)	.731	(18.6)	2.207	(56.1)
10	.755	(19.2)	2.862	(72.7)	.825	(21.0)	2.867	(72.8)
12	.848	(21.5)	2.972	(75.5)	.988	(25.1)	2.957	(75.1)
16	1.036	(26.3)	3.159	(80.2)	1.087	(27.6)	3.132	(79.6)
20	1.130	(28.7)	3.368	(85.5)	1.325	(33.7)	3.303	(83.9)
24	1.255	(31.9)	3.408	(86.6)	1.337	(34.0)	3.453	(87.7)
28	1.317	(33.5)	3.553	(90.2)	1.827	(46.4)	3.703	(94.1)
32	1.348	(34.2)	3.646	(92.6)	2.027	(51.5)	3.753	(95.3)

TABLE X: CABLE ENTRY						
Dash No.	T Max	V Max	Cable Range			
			Min		Max	
04	.780 (19.8)	.957 (24.3)	.125 (3.2)	.312 (7.9)		
06	.780 (19.8)	1.145 (29.1)	.250 (6.4)	.437 (11.1)		
08	.780 (19.8)	1.332 (33.8)	.387 (9.8)	.562 (14.3)		
10	.780 (19.8)	1.332 (33.8)	.350 (8.9)	.625 (15.9)		
12	.811 (20.6)	1.551 (39.4)	.500 (12.7)	.750 (19.1)		
16	.905 (23.0)	1.770 (45.0)	.625 (15.9)	.937 (23.8)		
20	1.092 (27.7)	2.113 (53.7)	.875 (22.2)	1.250 (31.8)		
24	1.124 (28.5)	2.363 (60.0)	1.000 (25.4)	1.375 (34.9)		
28	1.399 (35.5)	2.770 (70.4)	1.250 (31.8)	1.625 (41.3)		
32	1.399 (35.5)	3.020 (76.7)	1.437 (36.5)	1.875 (47.6)		

1. When maximum cable entry (page 22) is exceeded, Style 2 will be supplied. (Function S only).
2. Metric dimensions (mm) are indicated in parentheses.
3. Cable range is defined as the accommodations range for the wire bundle or cable. Dimensions shown are not intended for inspection criteria.
4. Consult factory for shorter lengths on straight backshells.
5. When using Connector Designator B refer to pages 18 and 19 for part number development.

TABLE XI: CABLE ENTRY							
Dash No.	W Max	X Max	Y Max	Z Max	Cable Range		
					Min **		Max
03*	.437 (11.1)	.760 (19.3)	.843 (21.4)	.630 (16.0)	.156 (4.0)	.250 (6.4)	
04*	.437 (11.1)	.760 (19.3)	.906 (23.0)	.755 (19.2)	.188 (4.8)	.312 (7.9)	
06*	.500 (12.7)	.760 (19.3)	1.093 (27.8)	.942 (23.9)	.281 (7.1)	.438 (11.1)	
08	.563 (14.3)	.760 (19.3)	1.187 (30.1)	1.067 (27.1)	.387 (9.8)	.562 (14.3)	
10	.563 (14.3)	.760 (19.3)	1.281 (32.5)	1.192 (30.3)	.375 (9.5)	.625 (15.9)	
12	.563 (14.3)	.760 (19.3)	1.500 (38.1)	1.380 (35.1)	.438 (11.1)	.750 (19.1)	
16	.656 (16.7)	1.073 (27.3)	1.719 (43.7)	1.535 (39.0)	.625 (15.9)	.938 (23.8)	
20	.656 (16.7)	1.323 (33.6)	2.062 (52.4)	1.848 (46.9)	.875 (22.2)	1.250 (31.8)	
24	.656 (16.7)	1.323 (33.6)	2.312 (58.7)	2.255 (57.3)	1.000 (25.4)	1.375 (34.9)	
28	1.188 (30.2)	1.572 (39.9)	2.719 (69.1)	2.505 (63.6)	1.250 (31.8)	1.625 (41.3)	
32*	1.187 (30.1)	1.572 (39.9)	2.969 (75.4)	2.755 (70.0)	1.437 (36.5)	1.875 (47.6)	
40*	1.125 (28.6)	1.572 (39.9)	3.531 (89.7)	3.255 (82.7)	1.875 (47.6)	2.375 (60.3)	

\* Not available in Style M clamp.      \*\* Not Applicable Style D