

## 1A LDO Voltage Regulator with "GreenOperation"

☆GreenOperation-Compatible

## ■ GENERAL DESCRIPTION

The XC6220 series is a highly accurate, low noise, high speed, low dropout, and large current CMOS voltage regulator with GreenOperation function. The series consists of a voltage reference, an error amplifier, a current limiter, an inrush current prevention circuit and a phase compensation circuit plus a driver transistor.

With a 0.2Ω on-resistance driver transistor integrated and with output currents up to 1A, the ultra low dropout voltage performance greatly extends battery life as does the GreenOperation function which can switch between high speed and power save modes automatically. Low ESR ceramic capacitors can be used for the output stabilization capacitor ( $C_L$ ).

Output voltage is selectable in 0.05V increments within the range of 0.8V~5.0V, using laser trimming technologies.

An over current protection circuit and a thermal shutdown circuit are built in. The over current protection circuit will operate when the output current reaches its limit current. The thermal shutdown circuit will operate when the junction temperature reaches its limit temperature. The inrush protection circuit works by controlling the inrush current which is charged to  $C_L$  when the IC starts up. In this way, any fluctuations to  $V_{IN}$  caused by inrush current during system start up can be minimized.

The CE function enables the output to be turned off and the IC becomes a stand-by mode resulting in greatly reduced power consumption.

## ■ APPLICATIONS

- CD-ROM, CD-R/RW drives
- DVD drives
- HDD drives
- MIDs, UMPCs
- Digital still cameras, Video cameras
- Portable AV equipment

## ■ FEATURES

<b>Maximum Output Current</b>	: 1000mA (TYP.:1200mA limit) ( $1.2V \leq V_{OUT} \leq 5.0V$ )
<b>Dropout Voltage</b>	: 20mV @ 100mA ( $V_{OUT}=3.0V$ ) : 60mV @ 300mA ( $V_{OUT}=3.0V$ )
<b>Operating Voltage Range</b>	: 1.6V ~ 6.0V
<b>Output Voltage Range</b>	: 0.8V ~ 5.0V (0.05V increments)
<b>Accuracy</b>	: $\pm 1\%$ ( $V_{OUT} \geq 2.0V$ ) : $\pm 20mV$ ( $V_{OUT} < 2.0V$ )
<b>Low Power Consumption</b>	: 8 $\mu A$ (TYP.) in PS mode : 50 $\mu A$ (TYP.) in HS mode
<b>Operating Temperature</b>	: - 40°C ~ +85°C
<b>Thermal Shutdown</b>	: Detect 150°C, Release 135°C(TYP.)
<b>Inrush Current Protection</b>	: 700mA (MAX.)
<b><math>C_L</math> Auto Discharge</b>	: XC6220B/D Series
<b>CE Pull-Down Resistor</b>	: XC6220C/D Series
<b>Output Capacitor</b>	: Ceramic Capacitor Compatible
<b>Packages</b>	: USP-6C, SOT-25, SOT-89-5
<b>Environmentally Friendly</b>	: EU RoHS Compliant, Pb Free

## ■ TYPICAL APPLICATION CIRCUIT

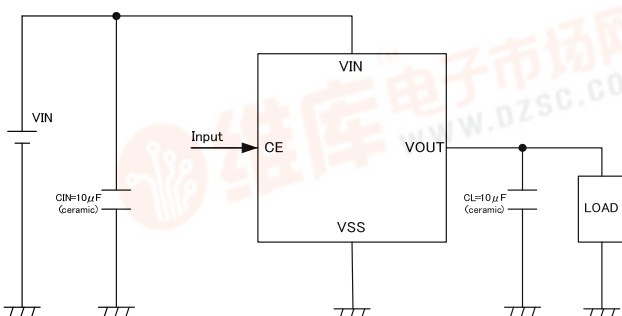

## ■ TYPICAL PERFORMANCE CHARACTERISTICS

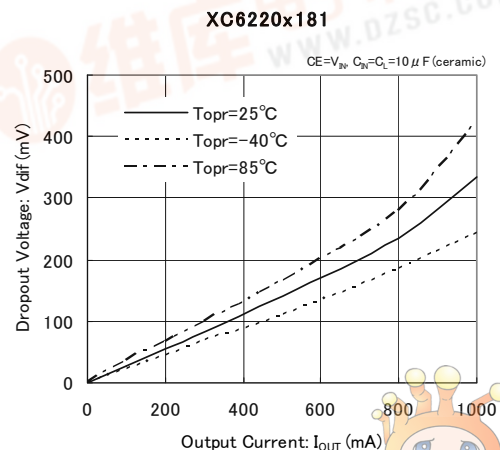

## ■ PIN CONFIGURATION

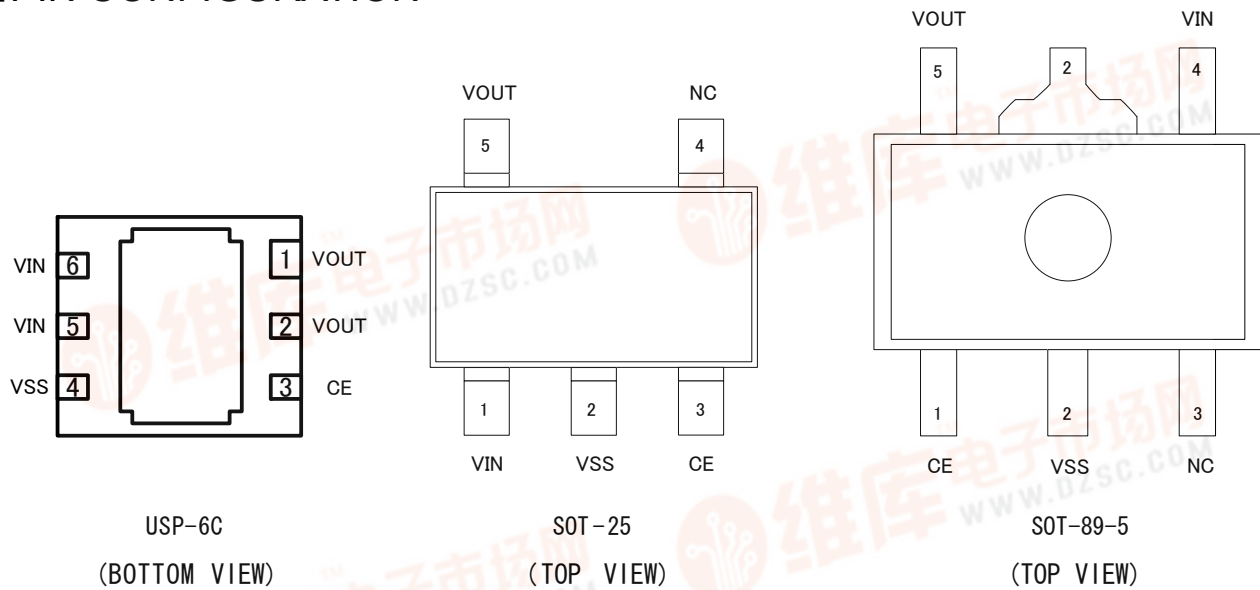

\* The No.5 and 6  $V_{IN}$  pins should be connected. The No.1 and 2 pins  $V_{OUT}$  pins should be connected. The dissipation pad for the USP-6C package should be solder-plated in recommended mount pattern and metal masking so as to enhance mounting strength and heat release. If the pad needs to be connected to other pins, it should be connected to the  $V_{SS}$  (No. 4)

## ■ PIN ASSIGNMENT

PIN NUMBER			PIN NAME	FUNCTIONS
SOT-25	SOT-89-5	USP-6C		
3	1	3	CE	ON/OFF Control
1	4	6 & 5	$V_{IN}$	Power Input
2	2	4	$V_{SS}$	Ground
5	5	1 & 2	$V_{OUT}$	Output
4	3	-	NC	No connection

[查询XC6220供应商](#)

## ■ PRODUCT CLASSIFICATION

### ● Selection Guide

Please see the optional setting for C<sub>L</sub> discharge and internal CE pull-down.

PRODUCT NAME	CONDITIONS
XC6220A	without CE Pull-down resistor, without C <sub>L</sub> auto discharge (Semi-custom)
XC6220B	without CE Pull-down resistor, with C <sub>L</sub> auto discharge (Standard)
XC6220C	with CE Pull-down resistor, without C <sub>L</sub> auto discharge (Semi-custom)
XC6220D	with CE Pull-down resistor, with C <sub>L</sub> auto discharge (Semi-custom)

### ● Ordering Information

XC6220 ①②③④⑤⑥-⑦<sup>(\*)</sup>

DESIGNATOR	DESCRIPTION	SYMBOL	DESCRIPTION
①	Type of CE	A	without CE Pull-down resistor, without C <sub>L</sub> discharge (Semi-custom)
		B	without CE Pull-down resistor, with C <sub>L</sub> discharge (Standard)
		C	with CE Pull-down resistor, without C <sub>L</sub> discharge (Semi-custom)
		D	with CE Pull-down resistor, with C <sub>L</sub> discharge (Semi-custom)
② ③	Output Voltage	08~50	e.g. 3.0V → ①=3, ②=0
④	Output Voltage Accuracy	1	Output voltage {O.O0v} (the 2 <sup>nd</sup> decimal place is "0") :HS Mode Accuracy ±1%(V <sub>OUT(T)</sub> ≥ 2.1V), within 0.02V (V <sub>OUT(T)</sub> ≤ 2.0V) :PS Mode Accuracy ±2%(V <sub>OUT(T)</sub> ≥ 2.1V), within 0.04V (V <sub>OUT(T)</sub> ≤ 2.0V)
		B	Output voltage {O.O5v} (the 2 <sup>nd</sup> decimal place is "5") :HS Mode Accuracy ±1%(V <sub>OUT(T)</sub> ≥ 2.05V), within 0.02V (V <sub>OUT(T)</sub> ≤ 1.95V) :PS Mode Accuracy ±2%(V <sub>OUT(T)</sub> ≥ 2.05V), within 0.04V (V <sub>OUT(T)</sub> ≤ 1.95V)
⑤⑥-⑦	Packages Taping Type <sup>(*)</sup>	MR	SOT-25
		MR-G	SOT-25
		PR	SOT-89-5
		PR-G	SOT-89-5
		ER	USP-6C
		ER-G	USP-6C

<sup>(\*)</sup> The "-G" suffix indicates that the products are Halogen and Antimony free as well as being fully RoHS compliant.

<sup>(\*)</sup> The device orientation is fixed in its embossed tape pocket. For reverse orientation, please contact your local Torex sales office or representative. (Standard orientation: ⑤R-⑦, Reverse orientation: ⑤L-⑦)

# XC6220 Series

[查询XC6220供应商](#)

## ■ BLOCK DIAGRAMS

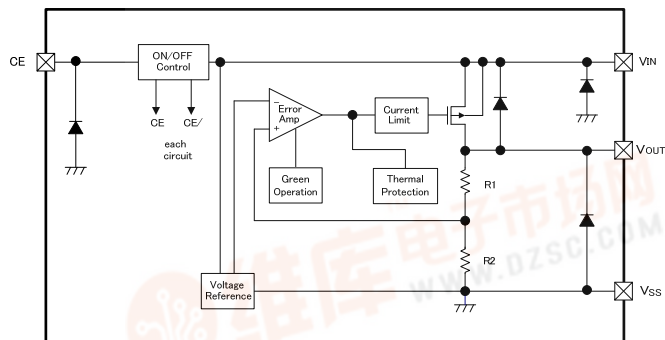

●XC6220A Series (Semi-custom)

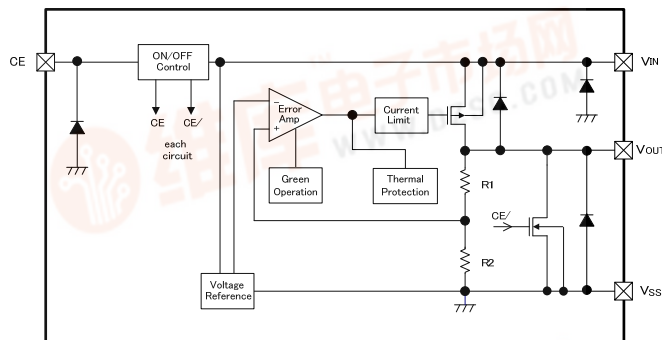

●XC6220B Series

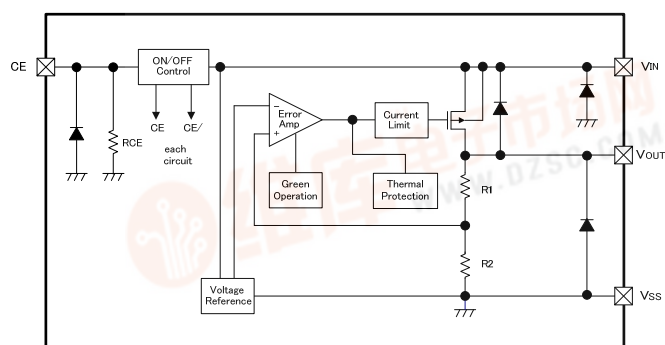

●XC6220C Series (Semi-custom)

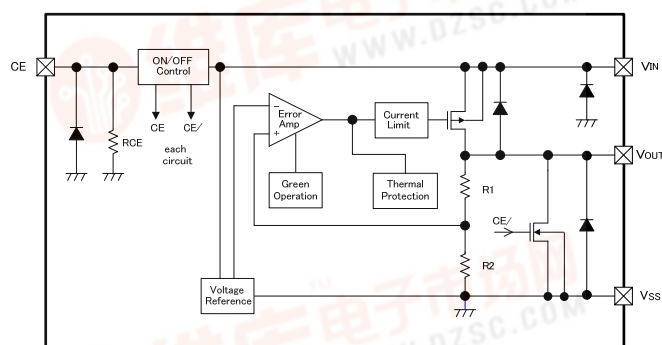

●XC6220D Series (Semi-custom)

\* Diodes inside the circuits are ESD protection diodes and parasitic diodes.

## ■ ABSOLUTE MAXIMUM RATINGS

Ta=25°C

PARAMETER	SYMBOL	RATINGS	UNITS
Input Voltage	V <sub>IN</sub>	6.5	V
Output Current <sup>(1)</sup>	I <sub>OUT</sub>	1400	mA
Output Voltage	V <sub>OUT</sub>	V <sub>SS</sub> -0.3 ~ V <sub>IN</sub> +0.3	V
CE Input Voltage	V <sub>CE</sub>	V <sub>SS</sub> -0.3 ~ 6.5	V
Power Dissipation	Pd	250	mW
		600 (PCB mounted) <sup>(2)</sup>	
		500	
		1300 (PCB mounted) <sup>(2)</sup>	
Operating Temperature Range	Topr	- 40 ~ + 85	°C
		Storage Temperature Range	

\*1 Please use within the range of I<sub>OUT</sub>=Pd / (V<sub>IN</sub> - V<sub>OUT</sub>)

\*2: The power dissipation figure shown is PCB mounted. Please refer to pages 15~17 for details.

[查询XC6220供应商](#)

## ■ ELECTRICAL CHARACTERISTICS

●XC6220A/B/C/D Series

Ta=25°C

PARAMETER	SYMBOL	CONDITIONS	MIN.	TYP.	MAX.	UNITS	CIRCUIT
Output Voltage	$V_{OUT(E)}$ (2)	High Speed Mode (HS) $2.0V \leq V_{OUT(T)} \leq 5.0V$ $V_{CE}=V_{IN}, I_{OUT}=30mA$	×0.99		×1.01	V	①
		High Speed Mode (HS) $0.8V \leq V_{OUT(T)} \leq 1.95V$ $V_{CE}=V_{IN}, I_{OUT}=30mA$	-0.02		+0.02		
		Power Save Mode (PS) $2.0V \leq V_{OUT(T)} \leq 5.0V$ $V_{CE}=V_{IN}, I_{OUT}=0.1mA$	×0.98		×1.02		
		Power Save Mode (PS) $0.8V \leq V_{OUT(T)} \leq 1.95V$ $V_{CE}=V_{IN}, I_{OUT}=0.1mA$	-0.04		+0.04		
Output Current	$I_{OUTMAX}$	High Speed Mode(HS), $V_{CE}=V_{IN}$ $V_{IN}=V_{OUT(T)}+1.0V$ $0.8V \leq V_{OUT(T)} \leq 1.15V$	700	1200	-	mA	①
		High Speed Mode(HS), $V_{CE}=V_{IN}$ $V_{IN}=V_{OUT(T)}+1.0V$ $1.2V \leq V_{OUT(T)} \leq 5.0V$	1000	1200	-		
Load Regulation	$\Delta V_{OUT}$	High Speed Mode (HS), $V_{CE}=V_{IN}$ $10mA \leq I_{OUT} \leq 300mA$	-	10	45	mV	①
Dropout Voltage1 <sup>(*)</sup>	Vdif	High Speed Mode (HS) $I_{OUT}=300mA, V_{CE}=V_{IN}$	see the Voltage Chart			mV	①
Dropout Voltage2 <sup>(*)</sup>	Vdif	High Speed Mode(HS) $I_{OUT}=1000mA, V_{CE}=V_{IN}$	see the Voltage Chart			mV	①
Supply Current 1	$I_{SS1}$	High Speed Mode(HS) $V_{IN}=V_{CE}=V_{OUT(T)}+1.0V$ $I_{OUT}=10mA$ (A/B Series)	-	50	108	$\mu A$	②
		High Speed Mode(HS) $V_{IN}=V_{CE}=V_{OUT(T)}+1.0V$ $I_{OUT}=10mA$ (C/D Series)	-	50	see the Voltage Chart		
Supply Current 2	$I_{SS2}$	Power Save Mode(PS) $V_{IN}=V_{CE}=V_{OUT(T)}+1.0V$ $I_{OUT}=0.1mA$	-	8	18	$\mu A$	②
		Power Save Mode(PS) $V_{IN}=V_{CE}=V_{OUT(T)}+1.0V$ $I_{OUT}=0.1mA$	-	8	see the Voltage Chart		
Stand-by Current	$I_{STBY}$	$V_{IN}=6.0V, V_{CE}=V_{SS}$	-0.1	0.01	0.1	$\mu A$	②
Line Regulation	$\frac{\Delta V_{OUT}}{(\Delta V_{IN} \cdot V_{OUT})}$	$V_{OUT(T)}+0.5V \leq V_{IN} \leq 6.0V$ : $1.1V \leq V_{OUT(T)} \leq 5.0V$ High Speed Mode (HS), $V_{CE}=V_{IN}$ $I_{OUT}=100mA$	-	0.01	0.20	%V	①
		$1.6V \leq V_{IN} \leq 6.0V$ : $0.8V \leq V_{OUT(T)} \leq 1.05V$ High Speed Mode (HS), $V_{CE}=V_{IN}$ $I_{OUT}=100mA$					
Input Voltage	$V_{IN}$		1.6	-	6.0	V	
Output Voltage Temperature Characteristics	$\frac{\Delta V_{OUT}}{(\Delta Ta \cdot V_{OUT})}$	High Speed Mode (HS), $V_{CE}=V_{IN}$ $I_{OUT}=30mA$ $-40^\circ C \leq Ta \leq 85^\circ C$	-	±100	-	ppm/°C	①

## ELECTRICAL CHARACTERISTICS (Continued)

PARAMETER	SYMBOL	CONDITIONS	MIN.	TYP.	MAX.	UNITS	CIRCUIT
Ripple Rejection Rate	PSRR	$V_{IN}=5.75V_{DC}+0.5V_{p-pAC}$ : $4.75V \leq V_{OUT(T)} \leq 5.0V$ High Speed Mode (HS), $V_{CE}=V_{IN}$ $I_{OUT}=30mA, f=1kHz$	-	50	-	dB	③
		$V_{IN}=\{V_{OUT(T)}+1.0\}$ $V_{DC}+0.5V_{p-pAC}$ : $0.85V \leq V_{OUT(T)} \leq 4.7V$ High Speed Mode (HS), $V_{CE}=V_{IN}$ $I_{OUT}=30mA, f=1kHz$					
		$V_{IN}=1.85V_{DC}+0.5V_{p-pAC}$ : $V_{OUT(T)}=0.8V$ High Speed Mode (HS), $V_{CE}=V_{IN}$ $I_{OUT}=30mA, f=1kHz$					
Limit Current	$I_{LIM}$	$V_{CE}=V_{IN}=V_{OUT(T)}+1.0V$ $0.8V \leq V_{OUT(T)} \leq 1.15V$	705	1200	-	mA	①
		$V_{CE}=V_{IN}$ $V_{IN}=V_{OUT(T)}+1.0V$ $1.2V \leq V_{OUT(T)} \leq 5.0V$	1005	1200	-		
Short Current	$I_{SHORT}$	$V_{CE}=V_{IN}$ Short $V_{OUT}$ to $V_{SS}$ level	-	180	-	mA	①
PS Switching Current	$I_{GOR}$	: $1.45V \leq V_{OUT(T)} \leq 5.0V$ $V_{IN}=V_{OUT(T)}+1.0V, V_{CE}="H" Level$ : $0.8V \leq V_{OUT(T)} \leq 1.4V$ $V_{IN}=1.6V, V_{CE}="H" Level$ $I_{OUT}=heavy to light load$	1.0	2.0	-	mA	⑤
HS Switching Current	$I_{GO}$	: $1.45V \leq V_{OUT(T)} \leq 5.0V$ $V_{IN}=V_{OUT(T)}+1.0V, V_{CE}="H" Level$ : $0.8V \leq V_{OUT(T)} \leq 1.4V$ $V_{IN}=1.6V, V_{CE}="H" Level$ $I_{OUT}=light to heavy load$	-	5.0	10	mA	⑤
Switch Current Hysteresis Range	$I_{GOhys}$	$I_{GOhys}=I_{GO}-I_{GOR}$	-	3.0	-	mA	⑤
PS Switching Delay Time	$t_{DPS}$	$V_{CE}=V_{IN}=V_{OUT(T)}+1.0V,$ (HS/PS Auto-Switching) Time until HS mode is changed-over to PS mode by $I_{GOR}$ .	see the Voltage Chart			$\mu s$	⑤
CE High Level Voltage	$V_{CEH}$	$V_{CE}=V_{IN}$	1.2	-	6.0	V	④
CE Low Level Voltage	$V_{CEL}$	$V_{CE}=V_{SS}$	-	-	0.4	V	④
CE High Level Current	$I_{CEH}$	$V_{CE}=V_{IN}$ (A/B series)	-0.1	-	0.1	$\mu A$	④
		$V_{CE}=V_{IN}=6.0V$ (C/D series)	-	9	15	$\mu A$	
CE Low Level Current	$I_{CEL}$	$V_{CE}=V_{SS}$	-0.1	-	0.1	$\mu A$	④
CL Discharge Resistance <sup>(7)</sup>	$R_{DCHG}$	$V_{IN}=6.0V, V_{OUT}=5.0V, V_{CE}=V_{SS}$	-	460	-	$\Omega$	①
Thermal Shutdown Detect Temperature	$T_{TSD}$	Junction Temperature	-	150	-	$^{\circ}C$	
Thermal Shutdown Release Temperature	$T_{TSR}$	Junction Temperature	-	135	-	$^{\circ}C$	
Inrush Current	$I_{RUSH}$	$V_{IN}=V_{OUT(T)}+1.0V, C_L=22 \mu F$ $V_{CE}=0V \rightarrow V_{OUT(T)}+1.0V$ (Only when rising and within 1ms)	-	-	700	mA	⑥

NOTE:

- \*1: Unless otherwise stated,  $V_{IN}=V_{OUT(T)}+1.0V$ .
- \*2:  $V_{OUT(E)}$  = Effective output voltage (see the voltage chart)  
(ie. The output voltage when " $V_{OUT(T)}+1.0V$ " is provided at the  $V_{IN}$  pin while maintaining a certain  $I_{OUT}$  value.
- \*3:  $V_{OUT(T)}$ : Nominal output voltage
- \*4:  $V_{dif}=\{V_{IN1}^{(6)} - V_{OUT1}^{(5)}\}$
- \*5:  $V_{OUT1}$ =A voltage equal to 98% of the  $V_{OUT(T)}$  when an amply stabilized  $I_{OUT} \{V_{OUT(T)}+1.0V\}$  is input in the HS mode.
- \*6:  $V_{IN1}$ =The input voltage when  $V_{OUT1}$  appears as input voltage is gradually decreased.
- \*7: For the XC6220B/D series only. The XC6220A/C series (semi-custom) discharges by resistors R1 and R2 only as shown in the block diagrams.
- \*8: For the XC6220A/C series, output voltage rises when the IC is in the high temperature stand-by mode.

[查询XC6220供应商](#)

## ■ ELECTRICAL CHARACTERISTICS (Continued)

● Voltage Chart 1

NOMINAL OUTPUT VOLTAGE (V)	OUTPUT VOLTAGE 1 (HS Mode) (V)		OUTPUT VOLTAGE 2 (PS Mode) (V)		DROPOUT VOLTAGE 1 Vdif 1 (mV) I <sub>OUT</sub> =300mA		DROPOUT VOLTAGE 2 Vdif 2 (mV) I <sub>OUT</sub> =1000mA		SUPPLY CURRENT 1 (XC6220C/D) (μA)		SUPPLY CURRENT 2 (XC6220C/D) (μA)		PS SWITCH DELAY TIME (μs)
	V <sub>OUT(T)</sub>	MIN.	MAX.	MIN.	MAX.	TYP.	MAX.	Vdif	MAX.	I <sub>SS1</sub>	MAX.	I <sub>SS2</sub>	MAX.
0.80	0.7800	0.8200	0.7600	0.8400	400	575	-	-	112.500	22.500	650		
0.85	0.8300	0.8700	0.8100	0.8900					112.625	22.625			
0.90	0.8800	0.9200	0.8600	0.9400					112.750	22.750			
0.95	0.9300	0.9700	0.9100	0.9900					112.875	22.875			
1.00	0.9800	1.0200	0.9600	1.0400	240	405	-	113.000	23.000				
1.05	1.0300	1.0700	1.0100	1.0900				113.125	23.125				
1.10	1.0800	1.1200	1.0600	1.1400	180	305	-	113.250	23.250				
1.15	1.1300	1.1700	1.1100	1.1900				113.375	23.375				
1.20	1.1800	1.2200	1.1600	1.2400	150	215	460	113.500	23.500				
1.25	1.2300	1.2700	1.2100	1.2900				113.625	23.625				
1.30	1.2800	1.3200	1.2600	1.3400				113.750	23.750				
1.35	1.3300	1.3700	1.3100	1.3900				113.875	23.875				
1.40	1.3800	1.4200	1.3600	1.4400				114.000	24.000				
1.45	1.4300	1.4700	1.4200	1.4800				114.125	24.125				
1.50	1.4800	1.5200	1.4700	1.5300	100	150	-	114.250	24.250				
1.55	1.5300	1.5700	1.5100	1.5900				114.375	24.375				
1.60	1.5800	1.6200	1.5600	1.6400				114.500	24.500				
1.65	1.6300	1.6700	1.6100	1.6900				114.625	24.625				
1.70	1.6800	1.7200	1.6600	1.7400				114.750	24.750				
1.75	1.7300	1.7700	1.7100	1.7900				114.875	24.875				
1.80	1.7800	1.8200	1.7600	1.8400				115.000	25.000				
1.85	1.8300	1.8700	1.8100	1.8900				115.125	25.125				
1.90	1.8800	1.9200	1.8600	1.9400				115.250	25.250				
1.95	1.9300	1.9700	1.9100	1.9900				115.375	25.375				
2.00	1.9800	2.0200	1.9600	2.0400	85	130	655	115.500	25.500				
2.05	2.0295	2.0705	2.0090	2.0910				115.625	25.625				
2.10	2.0790	2.1210	2.0580	2.1420				115.750	25.750				
2.15	2.1285	2.1715	2.1070	2.1930				115.875	25.875				
2.20	2.1780	2.2220	2.1560	2.2440				116.000	26.000				
2.25	2.2275	2.2725	2.2050	2.2950				116.125	26.125				
2.30	2.2770	2.3230	2.2540	2.3460				116.250	26.250				
2.35	2.3265	2.3735	2.3030	2.3970				116.375	26.375				
2.40	2.3760	2.4240	2.3520	2.4480				116.500	26.500				
2.45	2.4255	2.4745	2.4010	2.4990				116.625	26.625				
2.50	2.4750	2.5250	2.4500	2.5500	116.750	26.750							
2.55	2.5245	2.5755	2.4990	2.6010	116.875	26.875							
2.60	2.5740	2.6260	2.5480	2.6520	117.000	27.000							
2.65	2.6235	2.6765	2.5970	2.7030	117.125	27.125							
2.70	2.6730	2.7270	2.6460	2.7540	117.250	27.250							
2.75	2.7225	2.7775	2.6950	2.8050	117.375	27.375							
2.80	2.7720	2.8280	2.7440	2.8560	117.500	27.500							
2.85	2.8215	2.8785	2.7930	2.9070	117.625	27.625							
2.90	2.8710	2.9290	2.8420	2.9580	117.750	27.750							
2.95	2.9205	2.9795	2.8910	3.0090	117.875	27.875							
					65	110	-	117.500	27.500				
								117.625	27.625				
								117.750	27.750				
								117.875	27.875				
								117.500	27.500				
								117.625	27.625				
								117.750	27.750				
								117.875	27.875				
								117.500	27.500				
								117.625	27.625				

# XC6220 Series

[查询XC6220供应商](#)

## ELECTRICAL CHARACTERISTICS (Continued)

● Voltage Chart 2

NOMINAL OUTPUT VOLTAGE (V)	OUTPUT VOLTAGE (HS Mode) (V)		OUTPUT VOLTAGE (PS Mode) (V)		DROPOUT VOLTAGE 1 Vdif 1 (mV) I <sub>OUT</sub> =300mA		DROPOUT VOLTAGE 2 Vdif 2 (mV) I <sub>OUT</sub> =1000mA		SUPPLY CURRENT 1 (XC6220C/D) (μA)	SUPPLY CURRENT 2 (XC6220C/D) (μA)	PS SWITCH DELAY TIME (μs)
	V <sub>OUT</sub>		V <sub>OUT</sub>		Vdif		Vdif		I <sub>SS1</sub>	I <sub>SS2</sub>	t <sub>DPS</sub>
	V <sub>OUT(T)</sub>	MIN.	MAX.	MIN.	MAX.	TYP.	MAX.	MAX.	MAX.	MAX.	MAX.
3.00	2.9700	3.0300	2.9400	3.0600	60	95			118.000	28.000	1200
3.05	3.0195	3.0805	2.9890	3.1110					118.125	28.125	
3.10	3.0690	3.1310	3.0380	3.1620					118.250	28.250	
3.15	3.1185	3.1815	3.0870	3.2130					118.375	28.375	
3.20	3.1680	3.2320	3.1360	3.2640					118.500	28.500	
3.25	3.2175	3.2825	3.1850	3.3150					118.625	28.625	
3.30	3.2670	3.3330	3.2340	3.3660					118.750	28.750	
3.35	3.3165	3.3835	3.2830	3.4170					118.875	28.875	
3.40	3.3660	3.4340	3.3320	3.4680					119.000	29.000	
3.45	3.4155	3.4845	3.3810	3.5190					119.125	29.125	
3.50	3.4650	3.5350	3.4300	3.5700					119.250	29.250	
3.55	3.5145	3.5855	3.4790	3.6210					119.375	29.375	
3.60	3.5640	3.6360	3.5280	3.6720					119.500	29.500	
3.65	3.6135	3.6865	3.5770	3.7230					119.625	29.625	
3.70	3.6630	3.7370	3.6260	3.7740					119.750	29.750	
3.75	3.7125	3.7875	3.6750	3.8250					119.875	29.875	
3.80	3.7620	3.8380	3.7240	3.8760					120.000	30.000	
3.85	3.8115	3.8885	3.7730	3.9270					120.125	30.125	
3.90	3.8610	3.9390	3.8220	3.9780					120.250	30.250	
3.95	3.9105	3.9895	3.8710	4.0290					120.375	30.375	
4.00	3.9600	4.0400	3.9200	4.0800	53	85	655		120.500	30.500	1450
4.05	4.0095	4.0905	3.9690	4.1310					120.625	30.625	
4.10	4.0590	4.1410	4.0180	4.1820					120.750	30.750	
4.15	4.1085	4.1915	4.0670	4.2330					120.875	30.875	
4.20	4.1580	4.2420	4.1160	4.2840					121.000	31.000	
4.25	4.2075	4.2925	4.1650	4.3350					121.125	31.125	
4.30	4.2570	4.3430	4.2140	4.3860					121.250	31.250	
4.35	4.3065	4.3935	4.2630	4.4370					121.375	31.375	
4.40	4.3560	4.4440	4.3120	4.4880					121.500	31.500	
4.45	4.4055	4.4945	4.3610	4.5390					121.625	31.625	
4.50	4.4550	4.5450	4.4100	4.5900					121.750	31.750	
4.55	4.5045	4.5955	4.4590	4.6410					121.875	31.875	
4.60	4.5540	4.6460	4.5080	4.6920					122.000	32.000	
4.65	4.6035	4.6965	4.5570	4.7430					122.125	32.125	
4.70	4.6530	4.7470	4.6060	4.7940					122.250	32.250	
4.75	4.7025	4.7975	4.6550	4.8450					122.375	32.375	
4.80	4.7520	4.8480	4.7040	4.8960					122.500	32.500	
4.85	4.8015	4.8985	4.7530	4.9470					122.625	32.625	
4.90	4.8510	4.9490	4.8020	4.9980					122.750	32.750	
4.95	4.9005	4.9995	4.8510	5.0490					122.875	32.875	
5.00	4.9500	5.0500	4.9000	5.1000	123.000	33.000					





[查询XC6220供应商](#)

## OPERATIONAL EXPLANATION

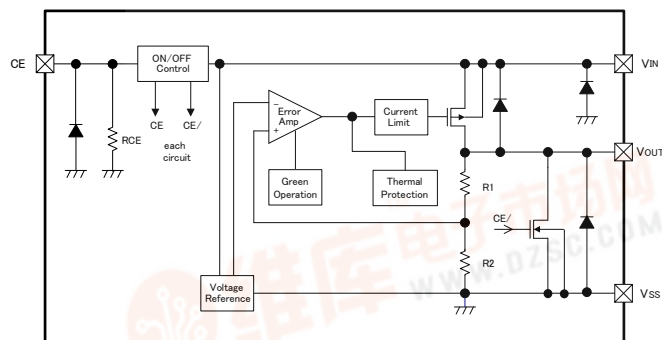

The voltage divided by resistors R1 & R2 is compared with the internal reference voltage by the error amplifier. The P-channel MOSFET which is connected to the V<sub>OUT</sub> pin is then driven by the subsequent output signal. The output voltage at the V<sub>OUT</sub> pin is controlled & stabilized by a system of negative feedback. The current limit circuit and short protect circuit operate in relation to the level of output current. The GO function monitors the output current and switches the IC between two operating modes according to the level of output current. Further, the IC's internal circuitry can be shutdown via the CE pin's signal.

### <GreenOperation>

The XC6220 series always operates in a green operation (GO) mode. The GO mode enables the IC to switch automatically between the high speed (HS) mode or the power save (PS) mode according to the level of output current. The switching point of the HS mode and the PS mode is fixed inside the IC. When the output current becomes I<sub>GOR</sub>=1.0mA (MIN.) or below, the mode changes automatically to the PS mode after a delay time of hundreds of microseconds. Supply current in light load is greatly reduced. Also when the output current becomes I<sub>GO</sub> 10mA (MAX.) or more, the mode changes automatically to the HS mode and the IC returns to high speed operation.

**XC6220x301**

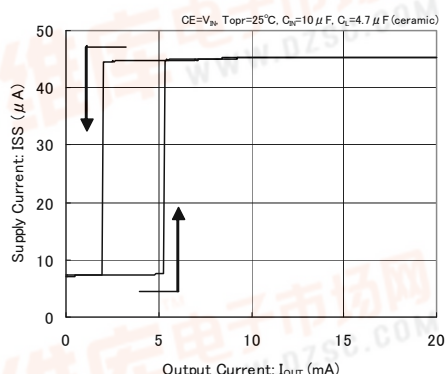

### <Low ESR capacitor>

The XC6220 series has a built-in phase compensation circuit which means that a stable output voltage is achieved even if the IC is used with low ESR capacitors. In order to ensure stable phase compensation it is recommended that a C<sub>L</sub> capacitor is connected as close as possible to the V<sub>OUT</sub> pin and V<sub>SS</sub> pin. For a stable power supply, please connect an input capacitor (C<sub>IN</sub>) between the V<sub>IN</sub> pin and the V<sub>SS</sub> pin. Values required for the phase compensation are shown in the chart below. If a loss of the capacitance happens, the stable phase compensation may not be obtained. Please ensure to use a capacitor which does not depend on bias or temperature too much.

Recommended output capacitor (C<sub>L</sub>) Values corresponding to input capacitor (C<sub>IN</sub>)

OUTPUT VOLTAGE (V)	INPUT CAPACITOR VALUE		
	4.7 μF	10 μF	22 μF
0.80V~0.95V	×	×	22 μF
1.00V~1.45V	47 μF	47 μF	22 μF
1.50V~1.75V	47 μF	22 μF	10 μF
1.80V~2.95V	47 μF	6.8 μF	6.8 μF
3.00V~3.50V	47 μF	4.7 μF	4.7 μF
3.55V~5.00V	47 μF	10 μF	6.8 μF

× No option

### <Current Limiter, Short-Circuit Protection>

The XC6220 series includes a fold-back circuit, which aids the operation of the current limiter and circuit protection. When the load current reaches the current limit level, the fold-back circuit operates and output voltage drops. As a result of this drop in output voltage, output current also decreases. When the output pin is shorted, a current of about 180mA flows.

### <CE Pin>

The IC's internal circuitry can be shutdown via the signal from the CE pin with the XC6220 series. With the XC6220B/D series, output at the V<sub>OUT</sub> pin will be pulled down to the V<sub>SS</sub> level. However, with XC6220A/B series, the C<sub>L</sub> auto-discharge resistor is connected in parallel to R1 and R2 while the power supply is applied to the V<sub>IN</sub> pin. Therefore, the time until the V<sub>OUT</sub> pin reaches the V<sub>SS</sub> level is shortened. The output voltage becomes unstable, when the CE pin is open. If this IC is used with the correct output voltage for the CE pin, the logic is fixed and the IC will operate normally. However, with the XC6220C/D series, supply current may increase as a result of through current in the IC's internal circuitry when medium voltage is input.

## OPERATIONAL EXPLANATION (Continued)

### <CL High Speed Auto-Discharge Function>

The XC6220B/D series can quickly discharge the electric charge at the output capacitor ( $C_L$ ), when a low signal to the CE pin, which enables the whole IC circuit put into an OFF state, is inputted to the CE pin via the N-channel transistor located between the  $V_{OUT}$  pin and the  $V_{SS}$  pin (cf. BLOCK DIAGRAM). The  $C_L$  auto-discharge resistance value is fixed to  $460\ \Omega$  ( $V_{IN}=6.0V$ ,  $V_{OUT}=5.0V$  at TYP.). The discharge time of the output capacitor ( $C_L$ ) is set by the  $C_L$  auto-discharge resistance ( $R_{DCHG}$ ) and the output capacitor ( $C_L$ ). By setting a time constant of the  $C_L$  auto-discharge resistance value [ $R_{DCHG}$ ] and an output capacitor value ( $C_L$ ) as  $\tau$  ( $\tau = C \times R_{DCHG}$ ), the output voltage after discharge via the N channel transistor is calculated by the following formulas.

$$V = V_{OUT} \times e^{-t/\tau}, \quad \text{or } t = \tau \ln( V_{OUT(E)} / V )$$

where

$V$  : Output voltage after discharge

$V_{OUT(E)}$  : Output voltage

$t$  : Discharge time

$\tau$  :  $C_L$  auto-discharge resistance  $R_{DCHG}$   $\times$  Output capacitor ( $C_L$ ) value  $C$

For the XC6220A/C series, output voltage may rises when in the high stand-by mode. Please note that in that case, the typical characteristics may worse. When the XC6220A/C series is used, please be noted the characteristics shown below.

XC6220A501xx

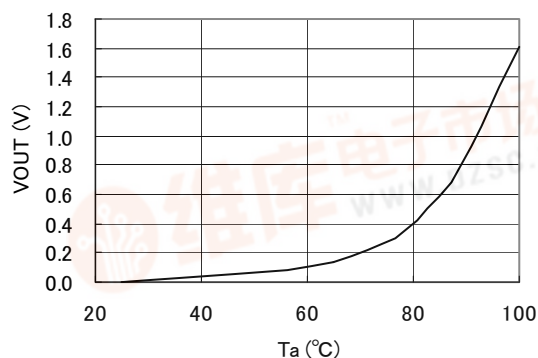

Output Voltage vs. Input Voltage

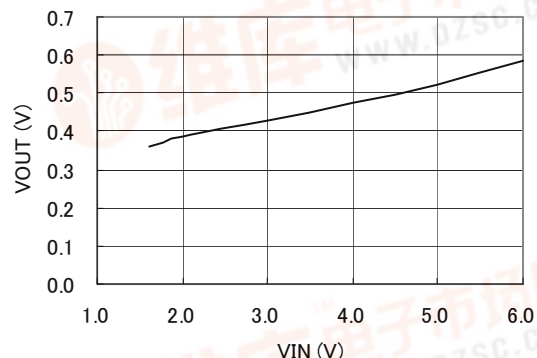

### <Thermal Shutdown>

When the junction temperature of the built-in driver transistor reaches the temperature limit level ( $150^\circ\text{C}$  TYP.), the thermal shutdown circuit operates and the driver transistor will be turned OFF. The IC resumes its operation when the thermal shutdown function is released and the IC's operation is automatically restored because the junction temperature drops to the level of the thermal shutdown release voltage.

### <Inrush Current Protection>

The XC6220 series includes an inrush current protection circuit.

The inrush current protection circuit suppresses inrush current charged to  $C_L$  when the IC starts up to 700 mA (MAX.) for approximately 1 ms.

\* Please note that the device can not provide the output current beyond 700 mA for a period of approximately 1 ms after the CE pin goes high.

## NOTES ON USE

1. Please use this IC within the stated absolute maximum ratings. The IC is liable to malfunction should the ratings be exceeded.
2. Where wiring impedance is high, operations may become unstable due to noise and/or phase lag depending on output current. Please strengthen  $V_{IN}$  and  $V_{SS}$  wiring in particular.
3. Please wire the input capacitor ( $C_{IN}$ ) and the output capacitor ( $C_L$ ) as close to the IC as possible.

[查询XC6220供应商](#)

## TEST CIRCUITS

Circuit 1: Output Voltage, Output Current, Dropout Voltage, Input/Operating Voltage, Line Regulation, Load Regulation, Current Limit, Short Current, CL Discharge Resistance

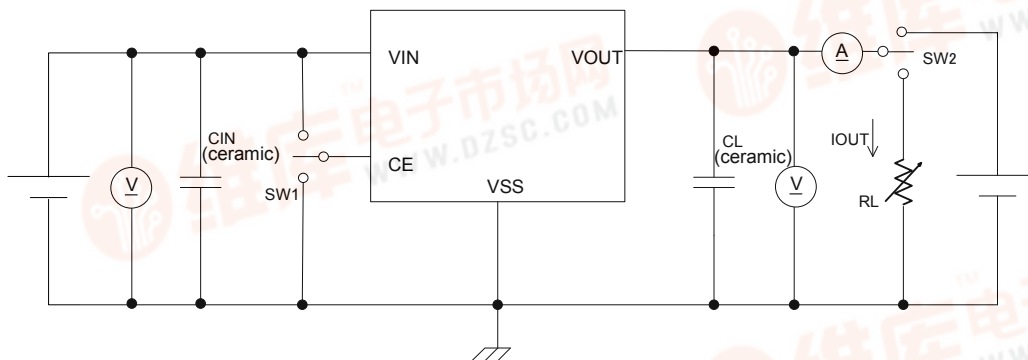

Circuit 2: Supply Current, Stand-by Current

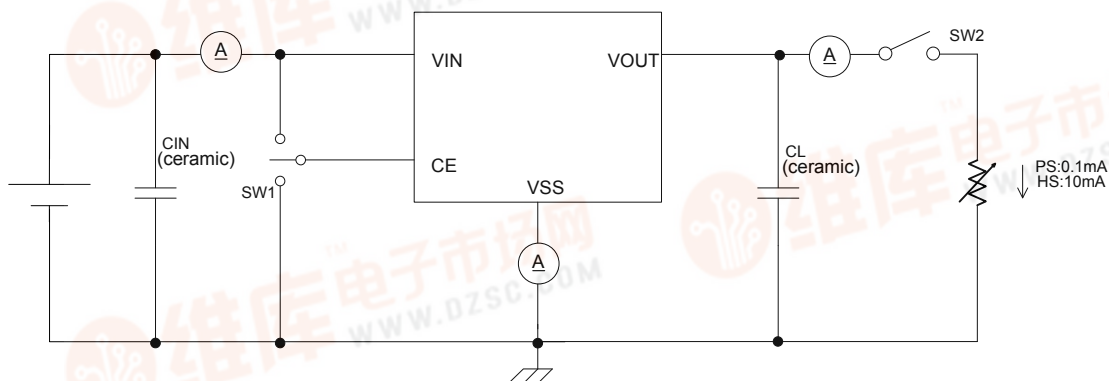

Circuit 3: Ripple Rejection Rate

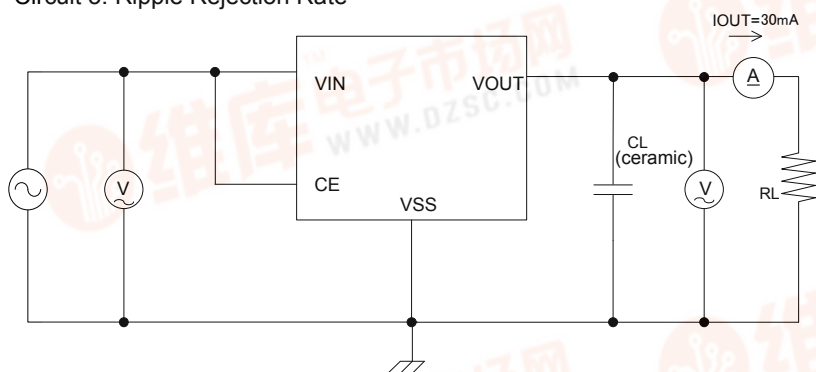

## TEST CIRCUITS (Continued)

Circuit 4: CE "H" "L" Level Voltage, CE "H" "L" Level Current

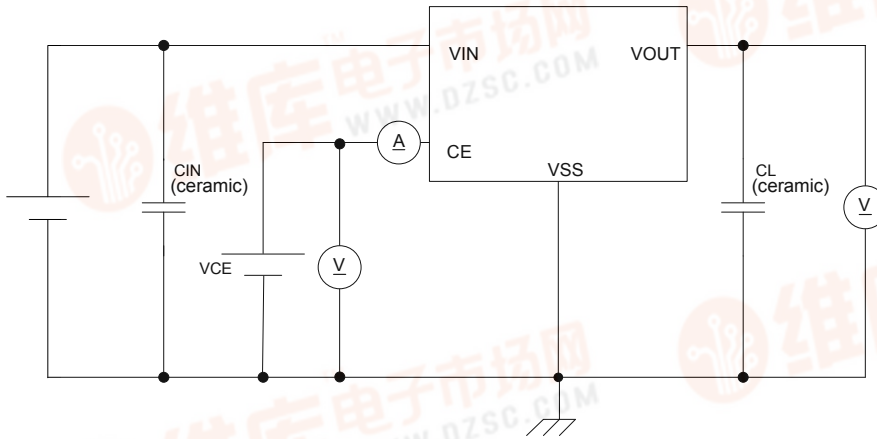

Circuit 5: HS Switching Current, PS Switching Current, Switch Current Hysteresis Range, PS Switching Delay Time

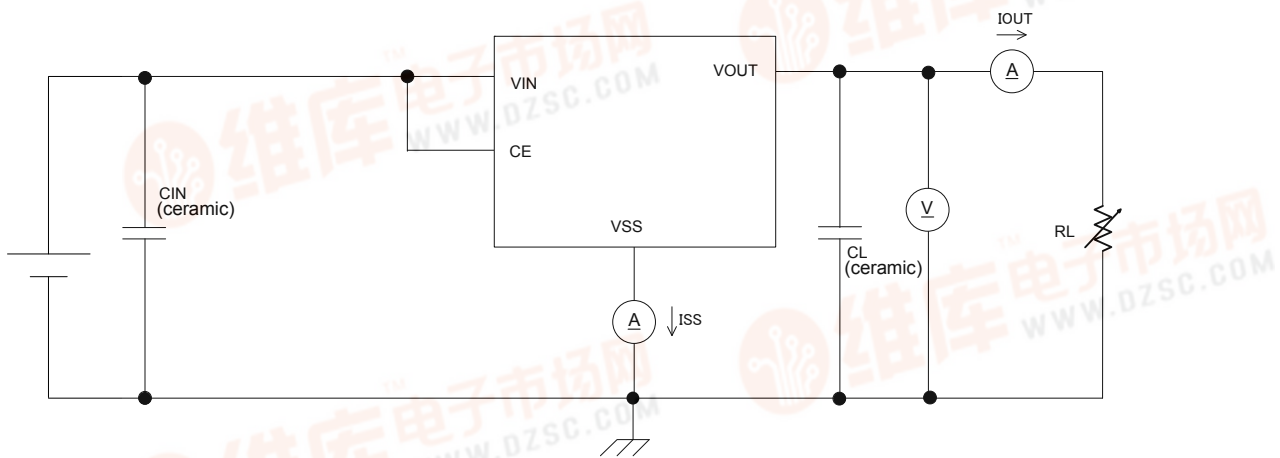

[查询XC6220供应商](#)

## TYPICAL PERFORMANCE CHARACTERISTICS

(1) Output Voltage vs. Output Current

**XC6220x121**

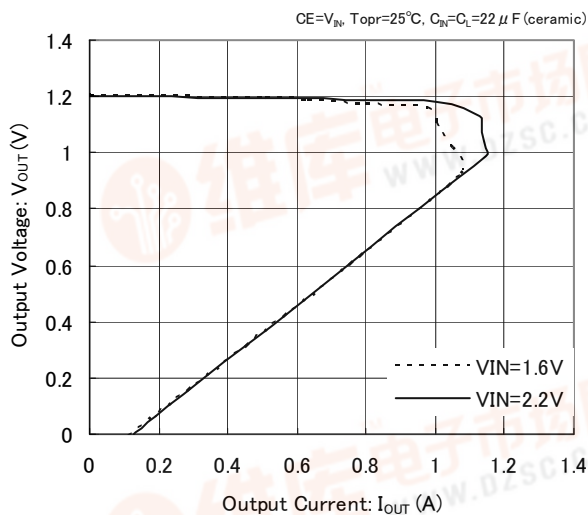

**XC6220x121**

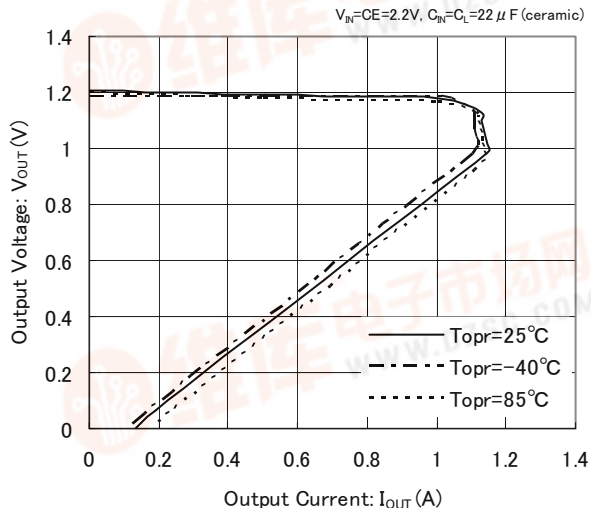

**XC6220x301**

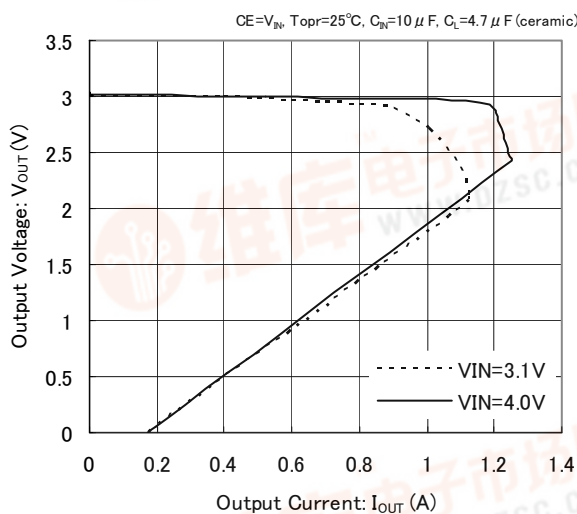

**XC6220x301**

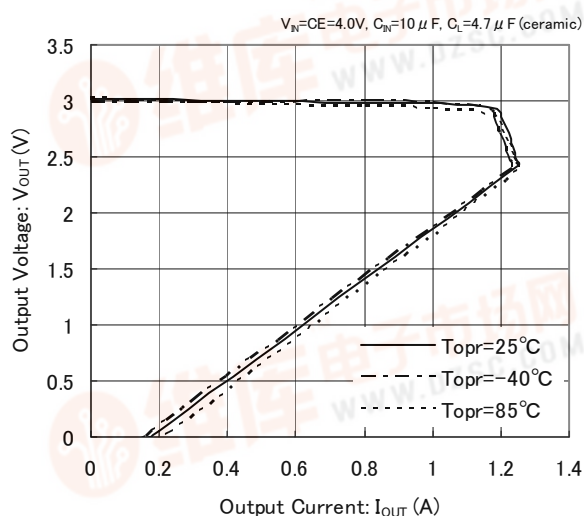

**XC6220x501**

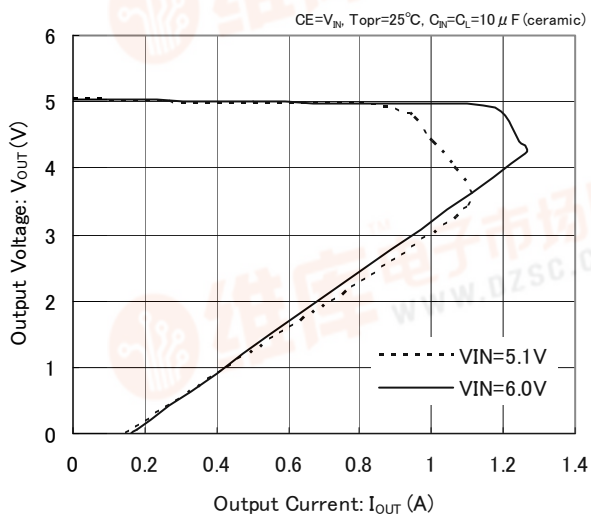

**XC6220x501**

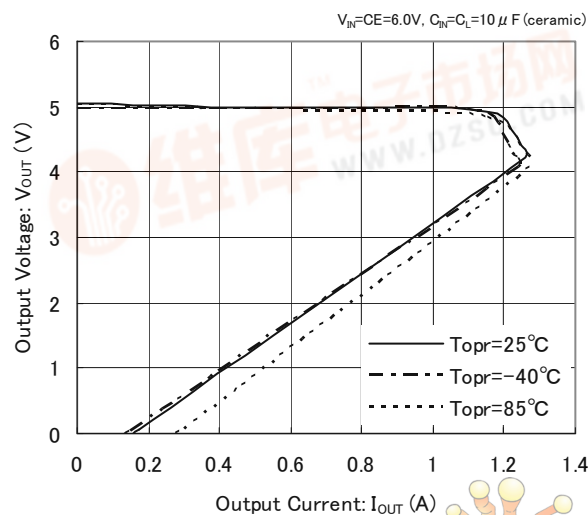

## TYPICAL PERFORMANCE CHARACTERISTICS (Continued)

### (2) Output Voltage vs. Input Voltage

**XC6220x121**

CE=V<sub>IN</sub>, T<sub>opr</sub>=25°C, C<sub>N</sub>=C<sub>L</sub>=22 μF (ceramic)

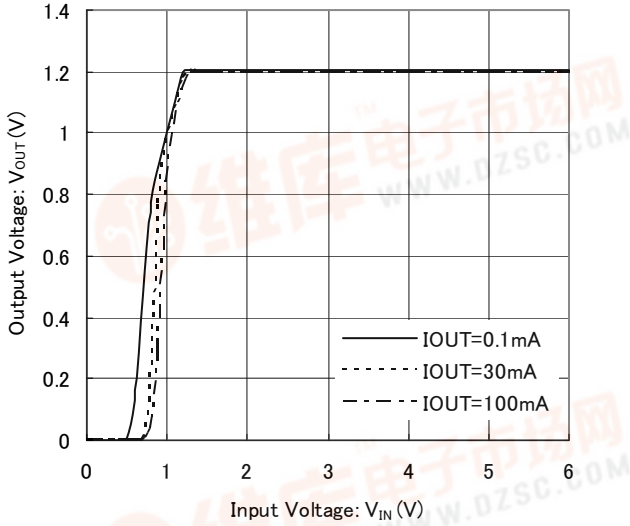

**XC6220x301**

CE=V<sub>IN</sub>, T<sub>opr</sub>=25°C, C<sub>N</sub>=10 μF, C<sub>L</sub>=4.7 μF (ceramic)

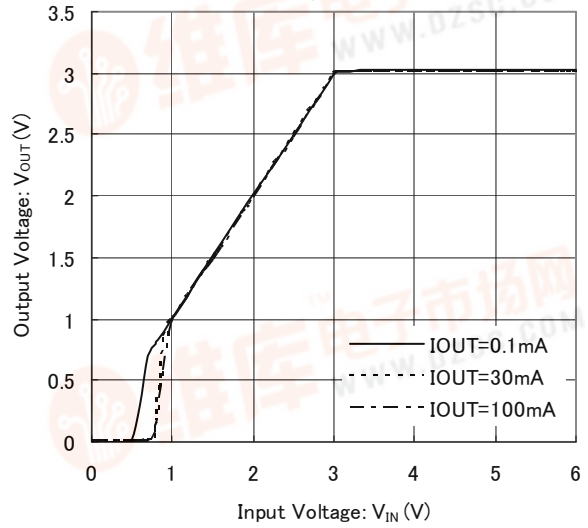

**XC6220x501**

CE=V<sub>IN</sub>, T<sub>opr</sub>=25°C, C<sub>N</sub>=C<sub>L</sub>=10 μF (ceramic)

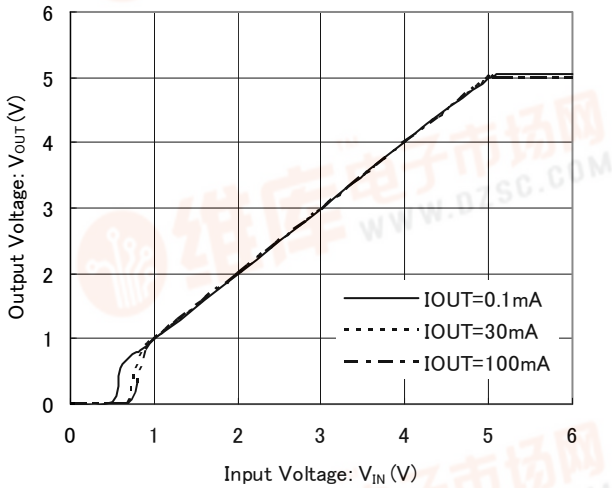

### (3) Dropout Voltage vs. Output Current

**XC6220x121**

CE=V<sub>IN</sub>, T<sub>opr</sub>=25°C, C<sub>N</sub>=C<sub>L</sub>=22 μF (ceramic)

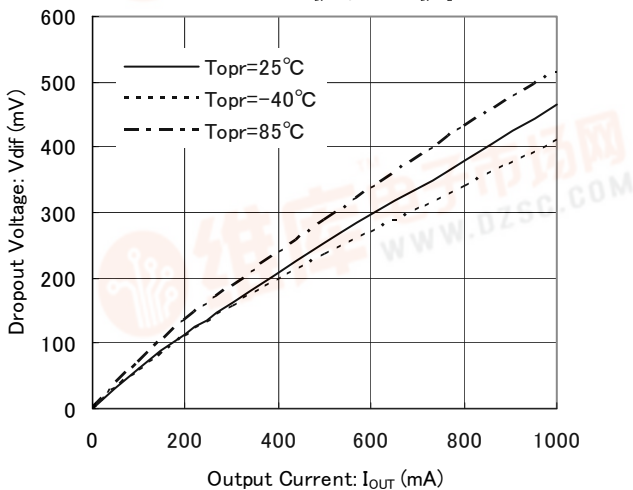

**XC6220x301**

CE=V<sub>IN</sub>, T<sub>opr</sub>=25°C, C<sub>N</sub>=10 μF, C<sub>L</sub>=4.7 μF (ceramic)

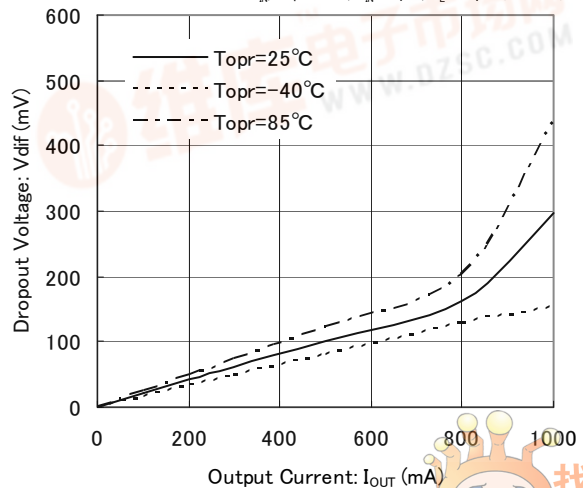

[查询XC6220供应商](#)

## ■ TYPICAL PERFORMANCE CHARACTERISTICS (Continued)

### (3) Dropout Voltage vs. Output Current

**XC6220x501**

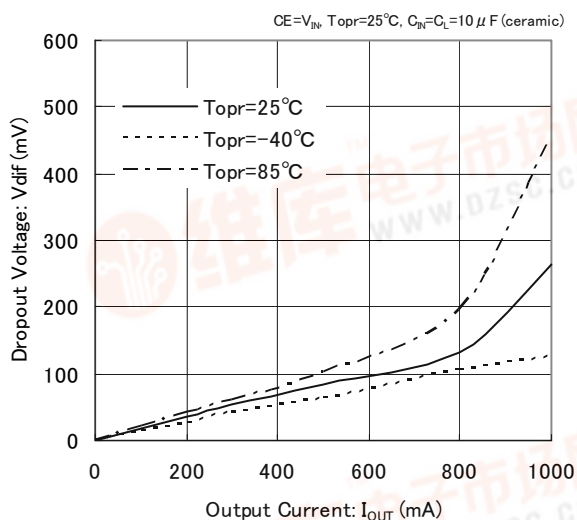

### (4) Output Voltage vs. Ambient Temperature

**XC6220x121**

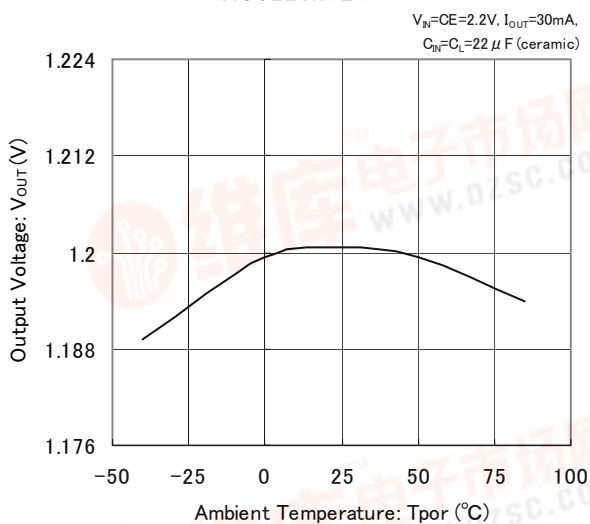

**XC6220x301**

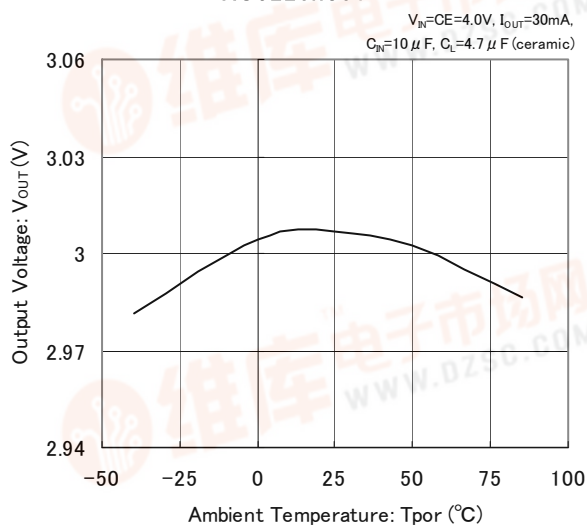

**XC6220x501**

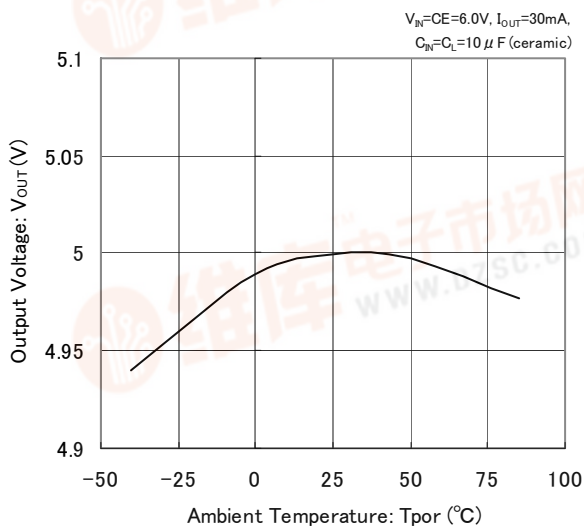

## TYPICAL PERFORMANCE CHARACTERISTICS (Continued)

### (5) Supply Current vs. Input Voltage

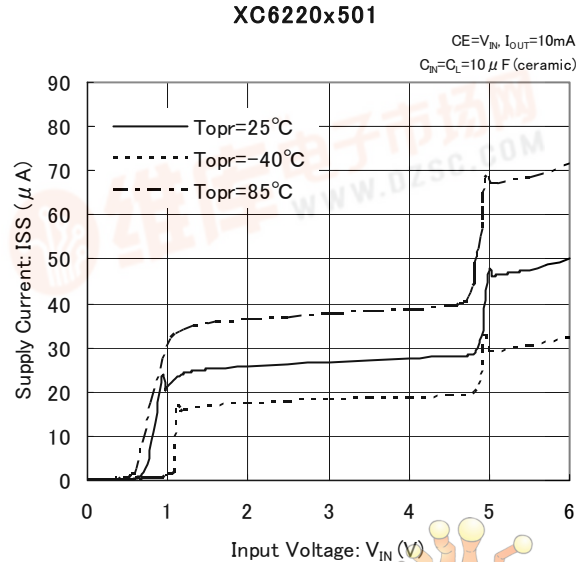
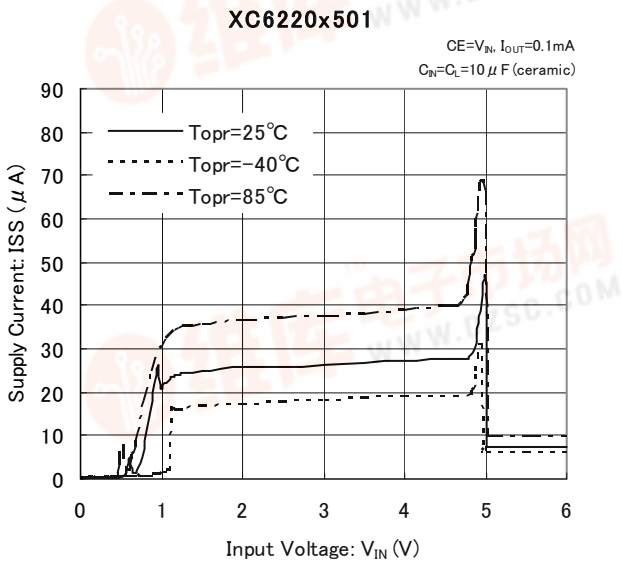
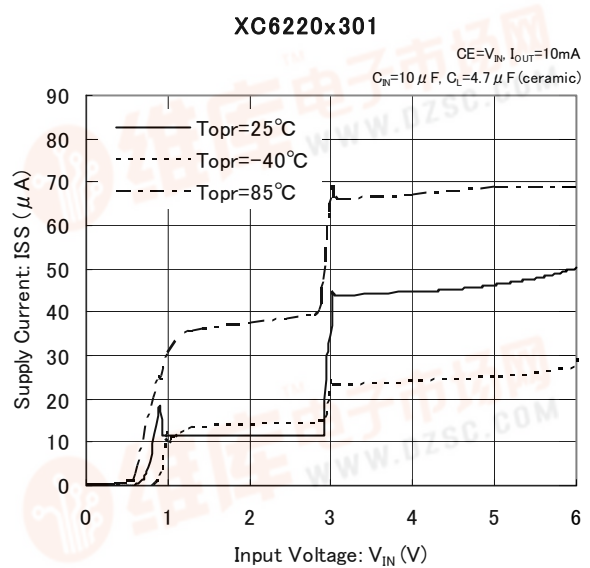
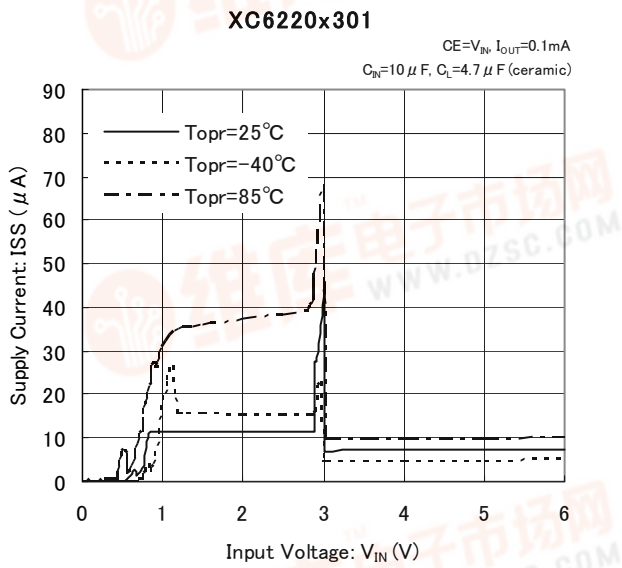
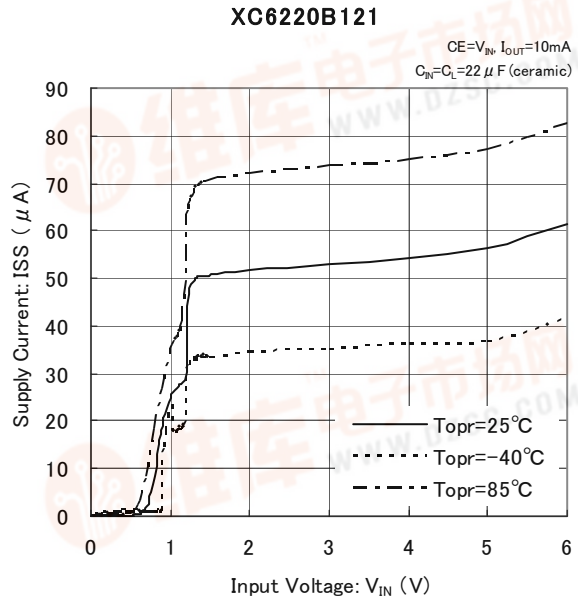
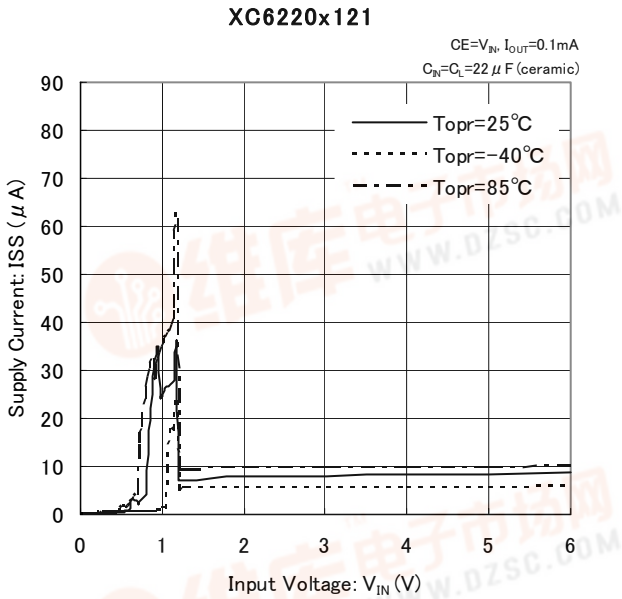



[查询XC6220供应商](#)

## ■ TYPICAL PERFORMANCE CHARACTERISTICS (Continued)

(6) PS Switching Delay Time vs. Ambient Temperature

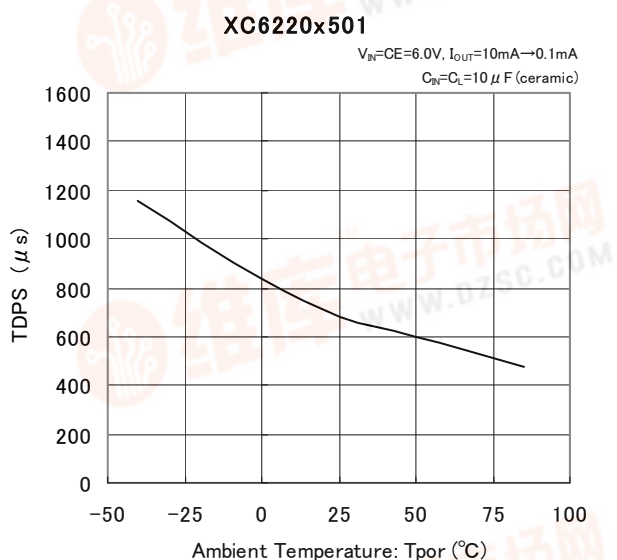
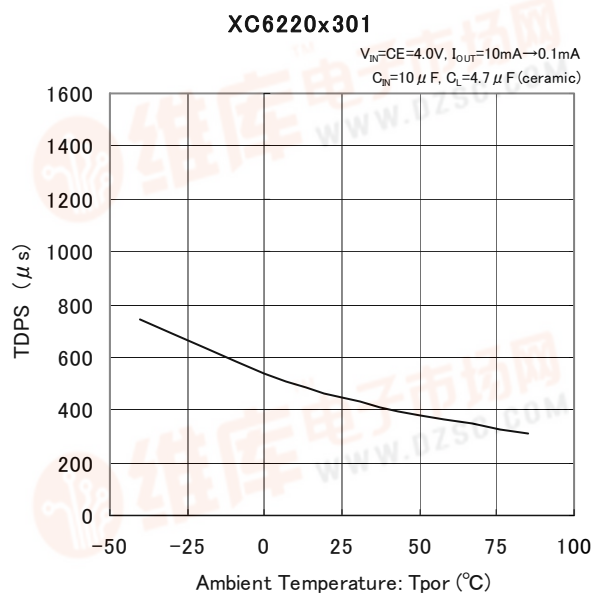
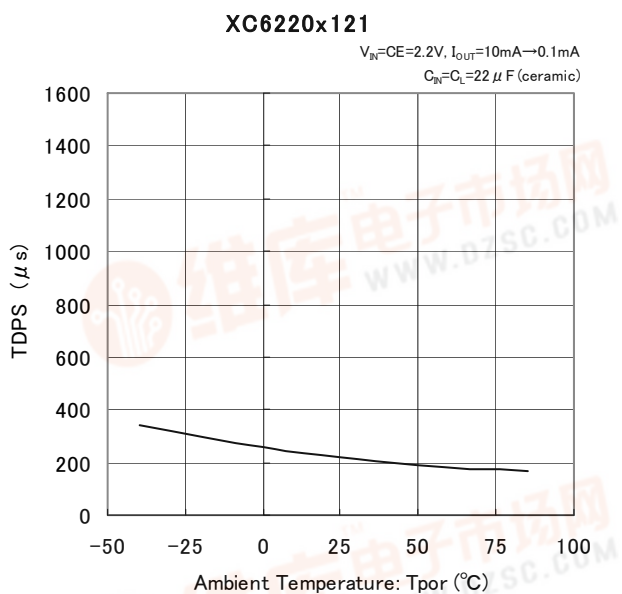

(7) CL Discharge Resistance vs. Ambient Temperature

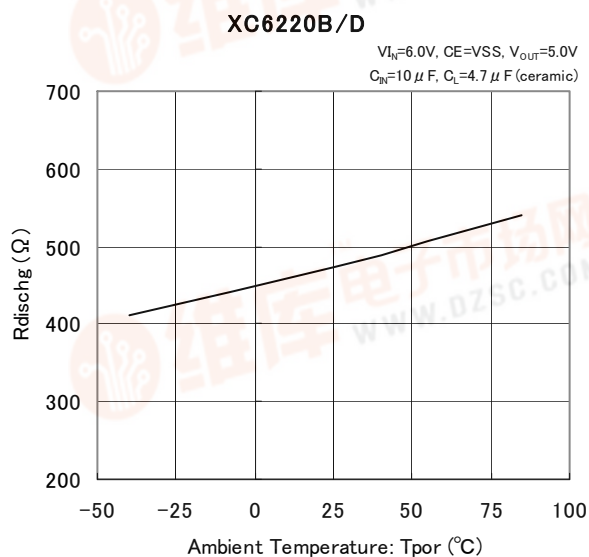

(8) PS/HS Switch Current vs. Ambient Temperature

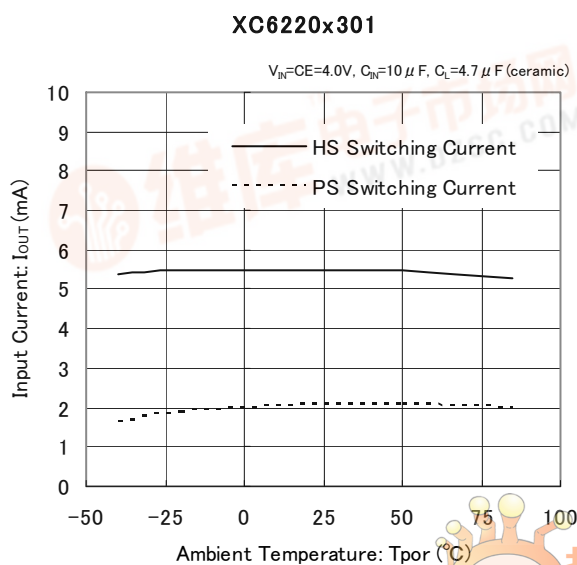

## TYPICAL PERFORMANCE CHARACTERISTICS (Continued)

### (9) Load Transient Response

**XC6220x121**

$V_{IN}=CE=2.2V$ ,  $T_r=T_f=5\mu s$   
 $T_{opr}=25^\circ C$ ,  $C_{IN}=C_L=22\mu F$  (ceramic)

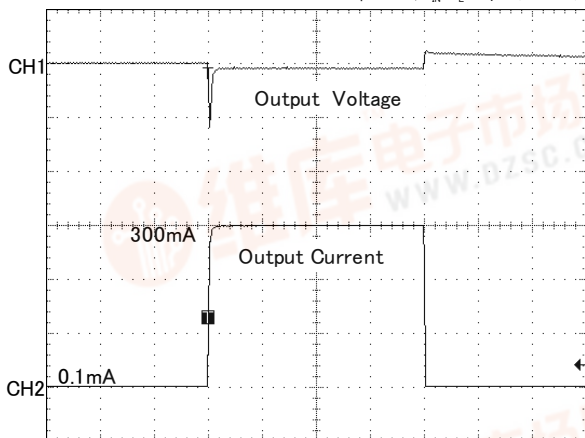

200  $\mu s$  / div  
 CH1 : 100mV / div CH2 : 100mA / div

**XC6220x121**

$V_{IN}=CE=2.2V$ ,  $T_r=T_f=5\mu s$   
 $T_{opr}=25^\circ C$ ,  $C_{IN}=C_L=22\mu F$  (ceramic)

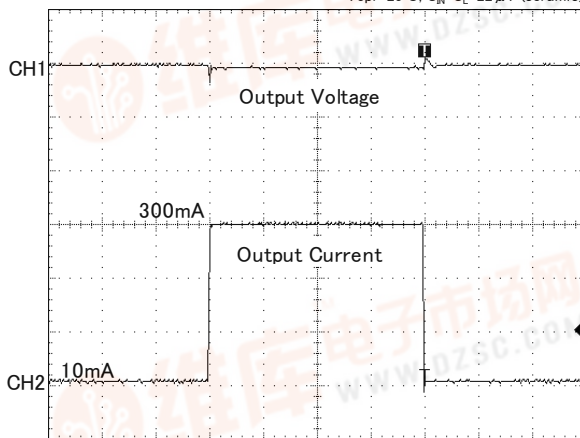

200  $\mu s$  / div  
 CH1 : 100mV / div CH2 : 100mA / div

**XC6220x301**

$V_{IN}=CE=4.0V$ ,  $T_r=T_f=5\mu s$   
 $T_{opr}=25^\circ C$ ,  $C_{IN}=10\mu F$ ,  $C_L=4.7\mu F$  (ceramic)

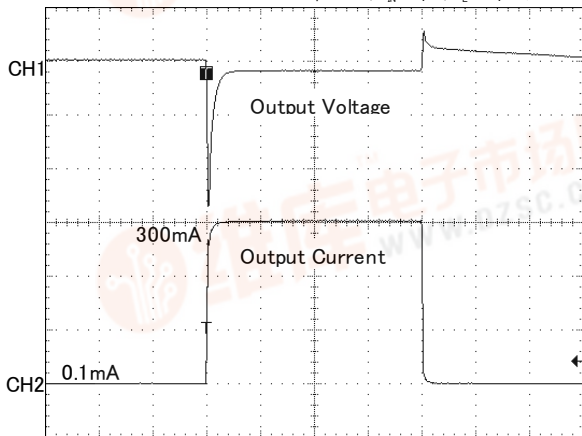

200  $\mu s$  / div  
 CH1 : 100mV / div CH2 : 100mA / div

**XC6220x301**

$V_{IN}=CE=4.0V$ ,  $T_r=T_f=5\mu s$   
 $T_{opr}=25^\circ C$ ,  $C_{IN}=10\mu F$ ,  $C_L=4.7\mu F$  (ceramic)

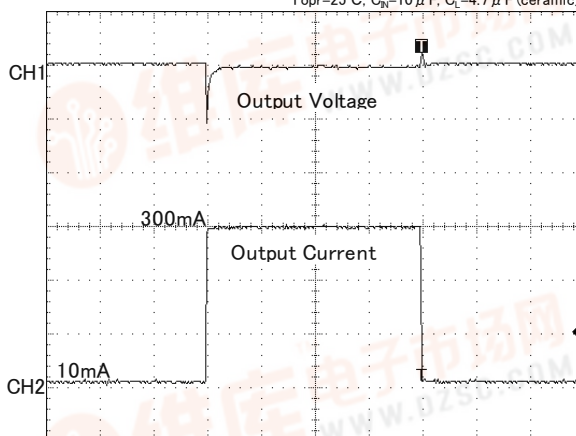

200  $\mu s$  / div  
 CH1 : 100mV / div CH2 : 100mA / div

**XC6220x501**

$V_{IN}=CE=6.0V$ ,  $T_r=T_f=5\mu s$   
 $T_{opr}=25^\circ C$ ,  $C_{IN}=C_L=10\mu F$  (ceramic)

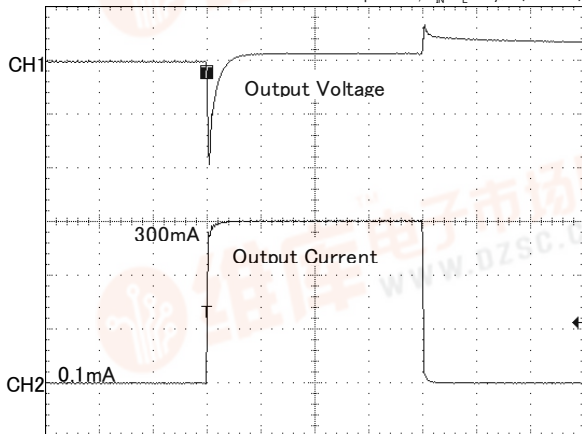

200  $\mu s$  / div  
 CH1 : 100mV / div CH2 : 100mA / div

**XC6220x501**

$V_{IN}=CE=6.0V$ ,  $T_r=T_f=5\mu s$   
 $T_{opr}=25^\circ C$ ,  $C_{IN}=C_L=10\mu F$  (ceramic)

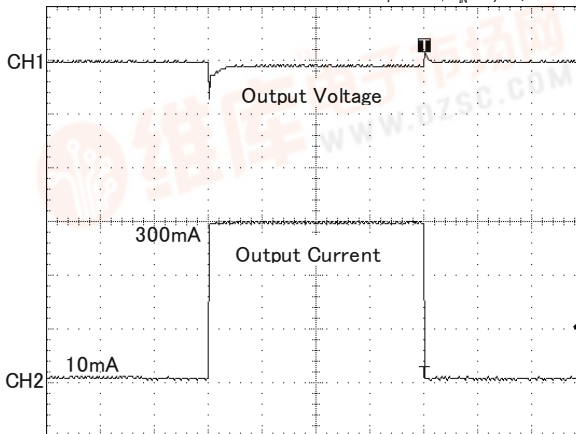

200  $\mu s$  / div  
 CH1 : 100mV / div CH2 : 100mA / div

[查询XC6220供应商](#)

## ■ TYPICAL PERFORMANCE CHARACTERISTICS (Continued)

### (10) Line Transient Response

**XC6220x121**

CE=V<sub>IN</sub>, Tr=Tf=5 μs, I<sub>OUI</sub>=100mA  
T<sub>opr</sub>=25°C, C<sub>IN</sub>=C<sub>L</sub>=22 μF (ceramic)

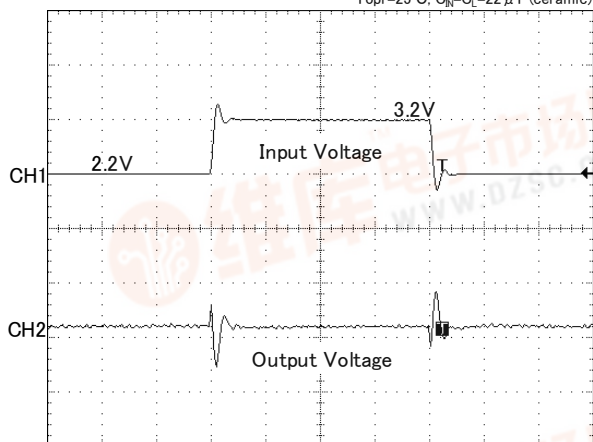

100 μs/div  
CH1: 1V/div CH2: 20mV/div

**XC6220x301**

CE=V<sub>IN</sub>, Tr=Tf=5 μs, I<sub>OUI</sub>=100mA  
T<sub>opr</sub>=25°C, C<sub>IN</sub>=10 μF, C<sub>L</sub>=4.7 μF (ceramic)

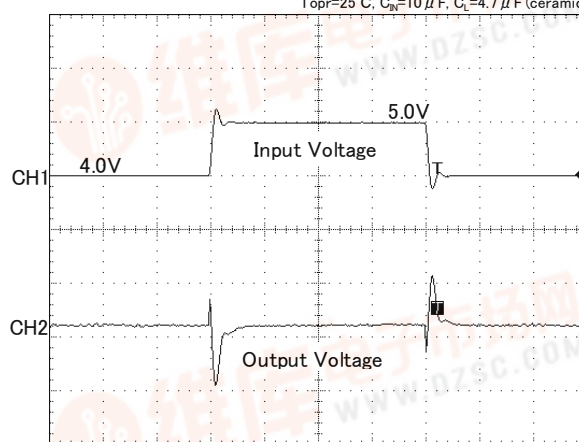

100 μs/div  
CH1: 1V/div CH2: 20mV/div

**XC6220x501**

CE=V<sub>IN</sub>, Tr=Tf=5 μs, I<sub>OUI</sub>=100mA  
T<sub>opr</sub>=25°C, C<sub>IN</sub>=C<sub>L</sub>=22 μF (ceramic)

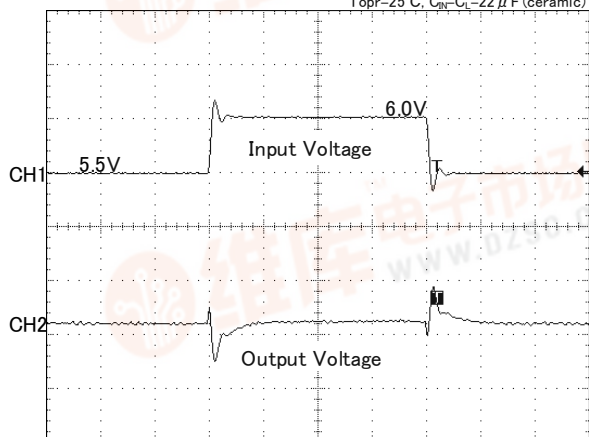

100 μs/div  
CH1: 500mV/div CH2: 20mV/div

### (11) Input Rise Characteristics

**XC6220x121**

CE=V<sub>IN</sub>, Tr=5 μs, I<sub>OUI</sub>=0.1mA  
T<sub>opr</sub>=25°C, C<sub>L</sub>=22 μF (ceramic)

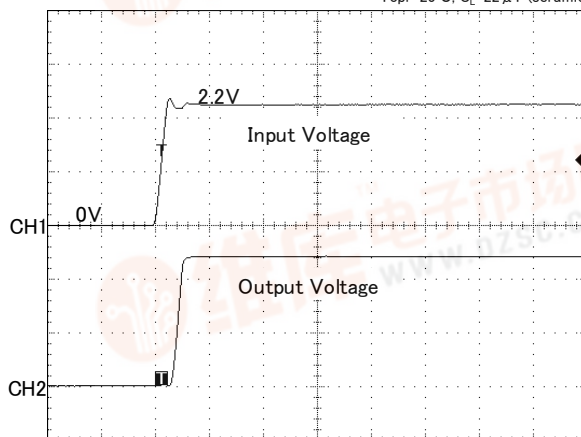

200 μs/div  
CH1: 1V/div CH2: 500mV/div

**XC6220x121**

CE=V<sub>IN</sub>, Tr=5 μs, I<sub>OUI</sub>=300mA  
T<sub>opr</sub>=25°C, C<sub>L</sub>=22 μF (ceramic)

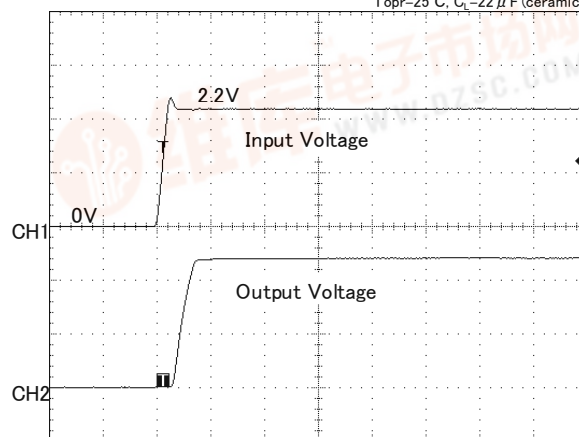

200 μs/div  
CH1: 1V/div CH2: 500mV/div

## TYPICAL PERFORMANCE CHARACTERISTICS (Continued)

### (11) Input Rise Characteristics

**XC6220x301**

CE= $V_{IN}$ , Tr=5  $\mu$ s, I<sub>OUT</sub>=0.1mA  
T<sub>opr</sub>=25°C, C<sub>L</sub>=4.7  $\mu$ F (ceramic)

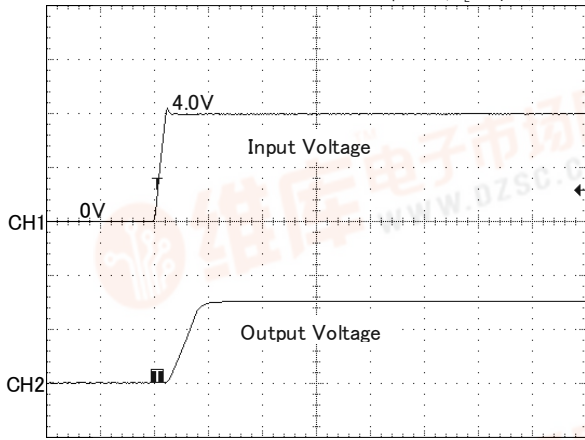

**XC6220x301**

CE= $V_{IN}$ , Tr=5  $\mu$ s, I<sub>OUT</sub>=300mA  
T<sub>opr</sub>=25°C, C<sub>L</sub>=4.7  $\mu$ F (ceramic)

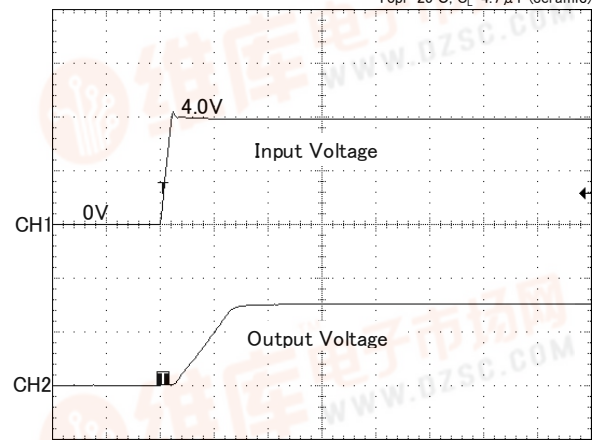

**XC6220x501**

CE= $V_{IN}$ , Tr=5  $\mu$ s, I<sub>OUT</sub>=0.1mA  
T<sub>opr</sub>=25°C, C<sub>L</sub>=22  $\mu$ F (ceramic)

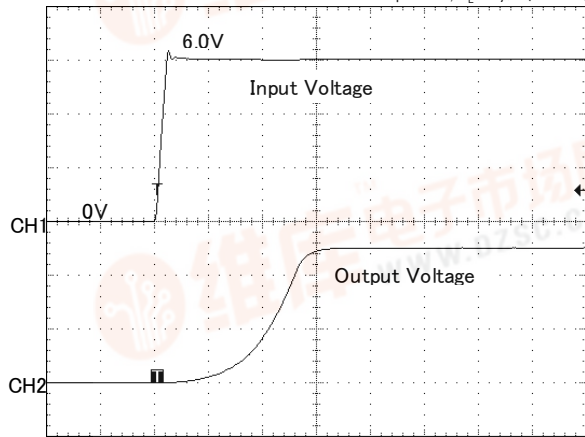

**XC6220x501**

CE= $V_{IN}$ , Tr=5  $\mu$ s, I<sub>OUT</sub>=300mA  
T<sub>opr</sub>=25°C, C<sub>L</sub>=22  $\mu$ F (ceramic)

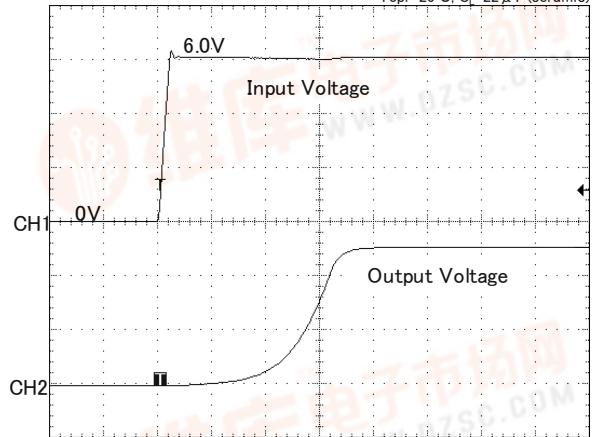

### (12) CE Rise Characteristics

**XC6220x121**

V<sub>IN</sub>=2.2V, Tr=5  $\mu$ s, I<sub>OUT</sub>=0.1mA  
T<sub>opr</sub>=25°C, C<sub>B</sub>=C<sub>L</sub>=22  $\mu$ F (ceramic)

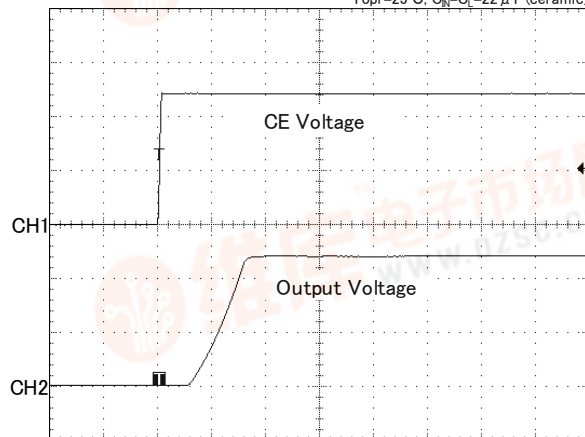

**XC6220x121**

V<sub>IN</sub>=2.2V, Tr=5  $\mu$ s, I<sub>OUT</sub>=300mA  
T<sub>opr</sub>=25°C, C<sub>B</sub>=C<sub>L</sub>=22  $\mu$ F (ceramic)

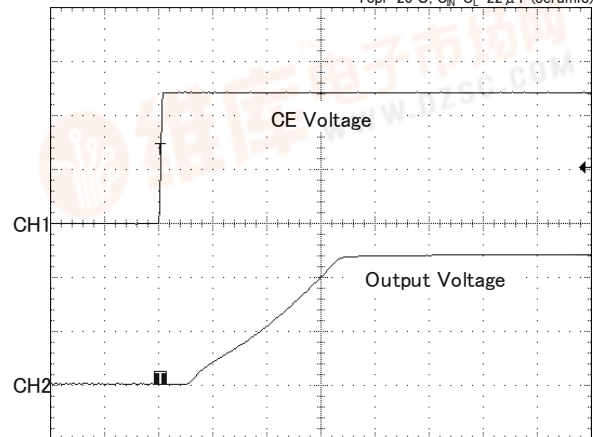

查询XC6220供应商

**TYPICAL PERFORMANCE CHARACTERISTICS (Continued)**

(12) CE Rise Characteristics

**XC6220x301**

$V_{IN}=4.0V$ ,  $T_r=5\mu s$ ,  $I_{OUT}=0.1mA$   
 $T_{opr}=25^\circ C$ ,  $C_{IN}=10\mu F$ ,  $C_L=4.7\mu F$  (ceramic)

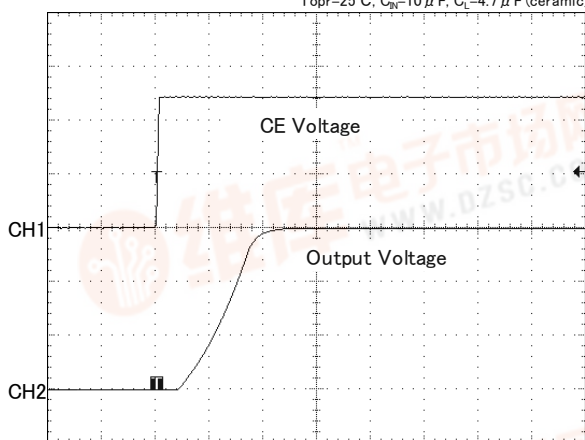

100  $\mu s$  / div  
CH1 : 500mV/div CH2 : 1V/div

**XC6220x301**

$V_{IN}=4.0V$ ,  $T_r=5\mu s$ ,  $I_{OUT}=300mA$   
 $T_{opr}=25^\circ C$ ,  $C_{IN}=10\mu F$ ,  $C_L=4.7\mu F$  (ceramic)

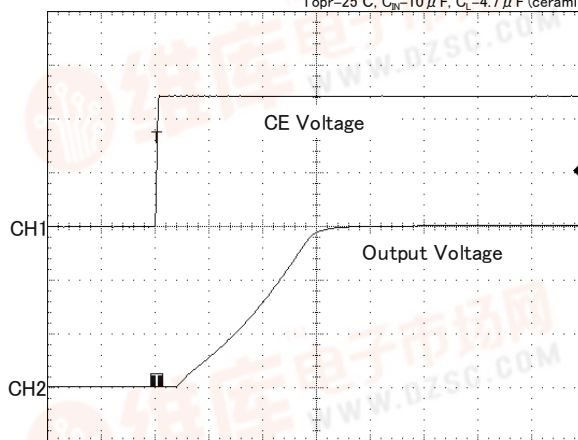

100  $\mu s$  / div  
CH1 : 500mV/div CH2 : 1V/div

**XC6220x501**

$V_{IN}=6.0V$ ,  $T_r=5\mu s$ ,  $I_{OUT}=0.1mA$   
 $T_{opr}=25^\circ C$ ,  $C_{IN}=C_L=10\mu F$  (ceramic)

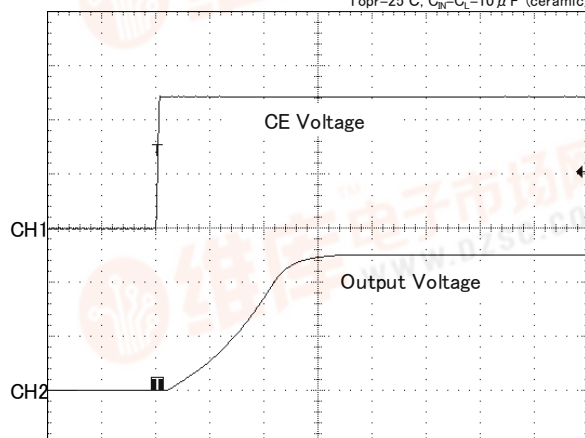

100  $\mu s$  / div  
CH1 : 500mV/div CH2 : 2V/div

**XC6220x501**

$V_{IN}=6.0V$ ,  $T_r=5\mu s$ ,  $I_{OUT}=300mA$   
 $T_{opr}=25^\circ C$ ,  $C_{IN}=C_L=10\mu F$  (ceramic)

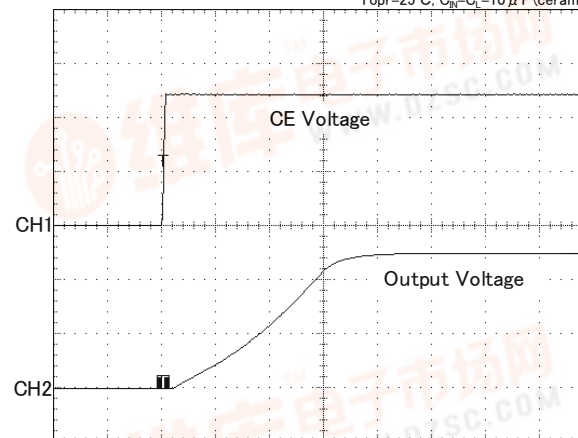

100  $\mu s$  / div  
CH1 : 500mV/div CH2 : 2V/div

(13) Inrush Current

**XC6220x121**

$V_{IN}=2.2V$ ,  $T_r=5\mu s$   
 $T_{opr}=25^\circ C$ ,  $C_{IN}=C_L=22\mu F$  (ceramic)

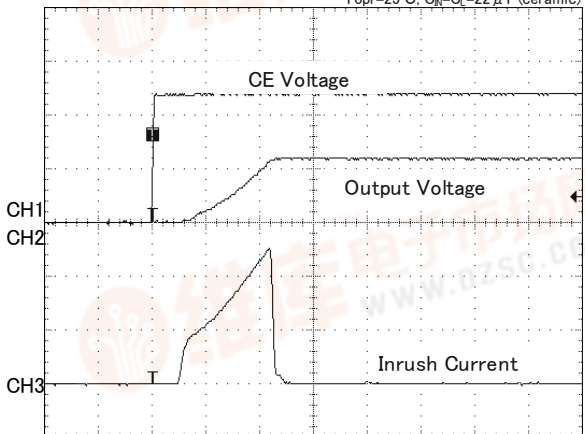

100  $\mu s$  / div  
CH1 : 500mV/div CH2 : 1V/div CH3 : 100mA/div

**XC6220x301**

$V_{IN}=4.0V$ ,  $T_r=5\mu s$   
 $T_{opr}=25^\circ C$ ,  $C_{IN}=10\mu F$ ,  $C_L=4.7\mu F$  (ceramic)

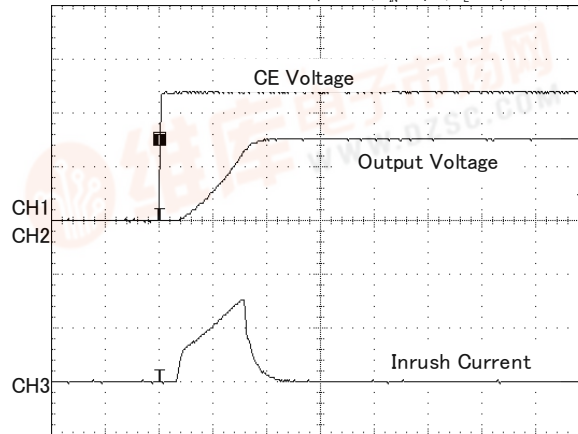

100  $\mu s$  / div  
CH1 : 500mV/div CH2 : 1V/div CH3 : 100mA/div

## TYPICAL PERFORMANCE CHARACTERISTICS (Continued)

### (13) Inrush Current

#### XC6220x501

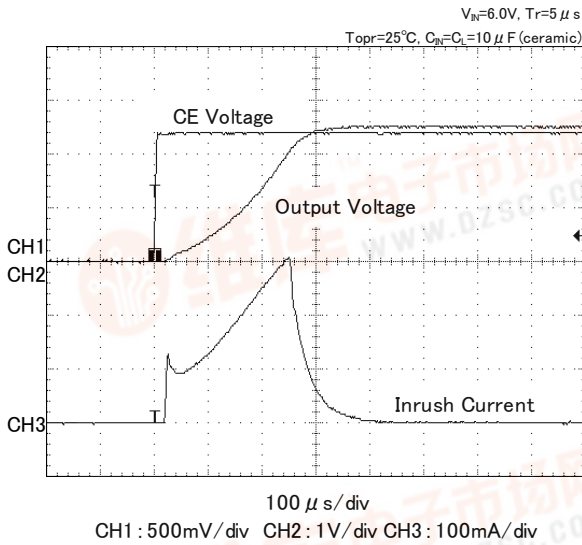

### (14) CL Discharge Time

#### XC6220x301 (B/D)

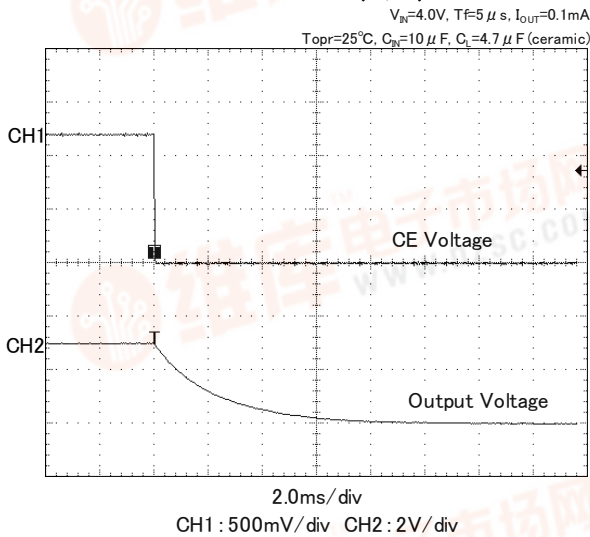

#### XC6220x301 (A/C)

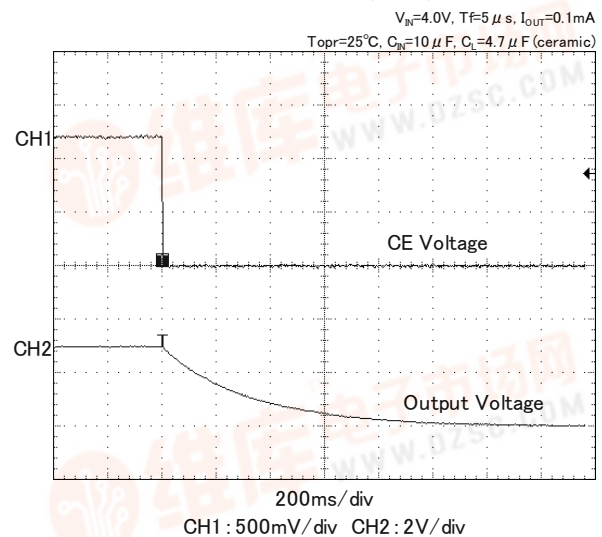

### (15) Ripple Rejection Rate

#### XC6220x121 (HighSpeed mode)

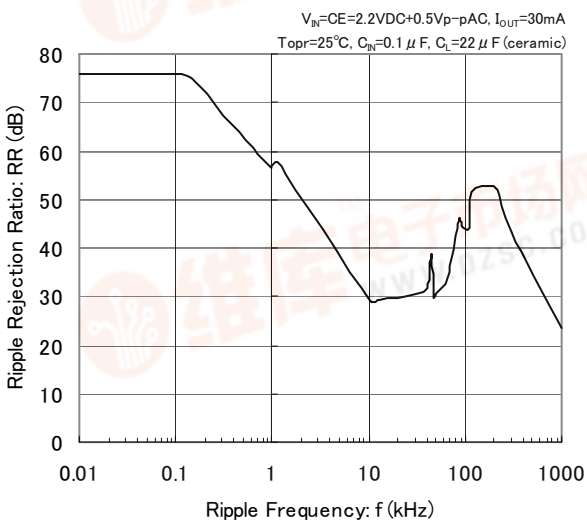

#### XC6220x121 (PowerSave mode)

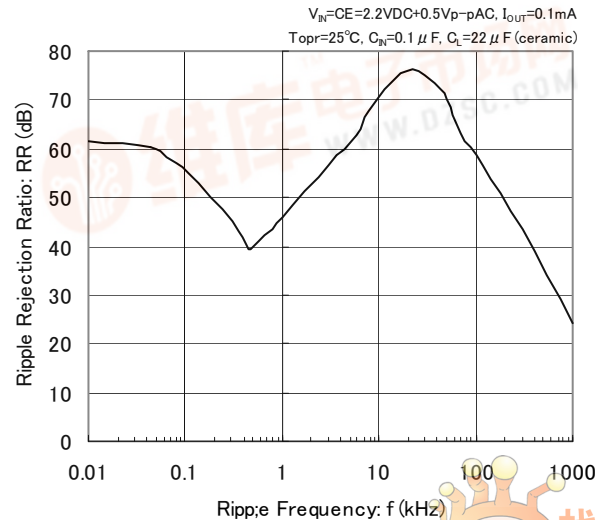

[查询XC6220供应商](#)

**TYPICAL PERFORMANCE CHARACTERISTICS (Continued)**

(15) Ripple Rejection Rate

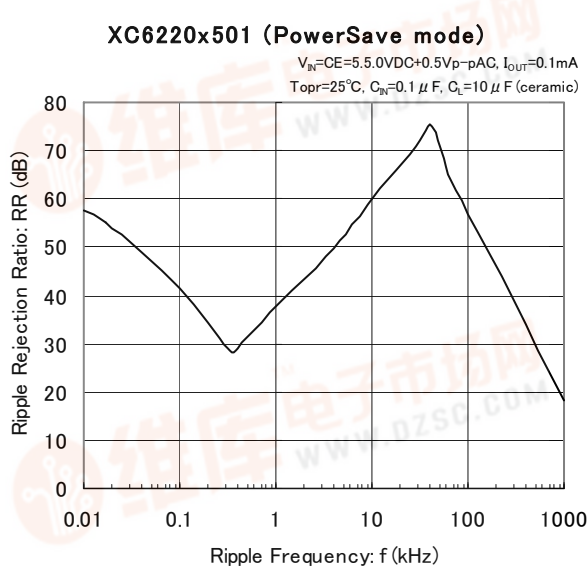
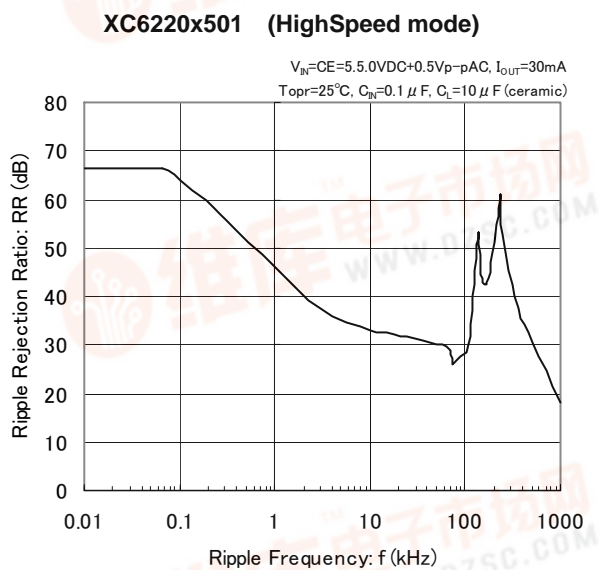
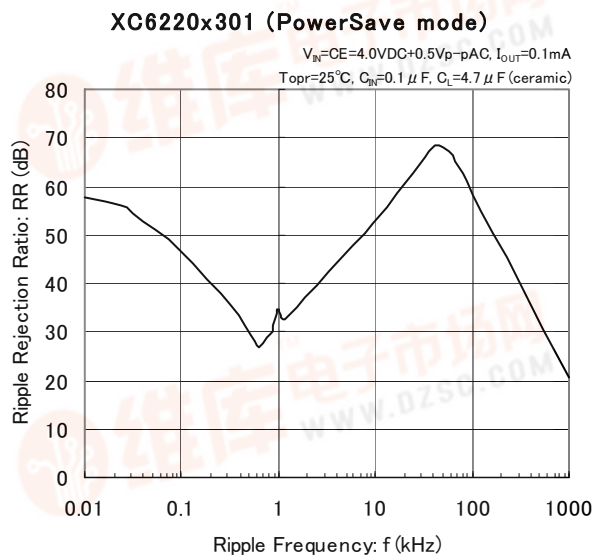
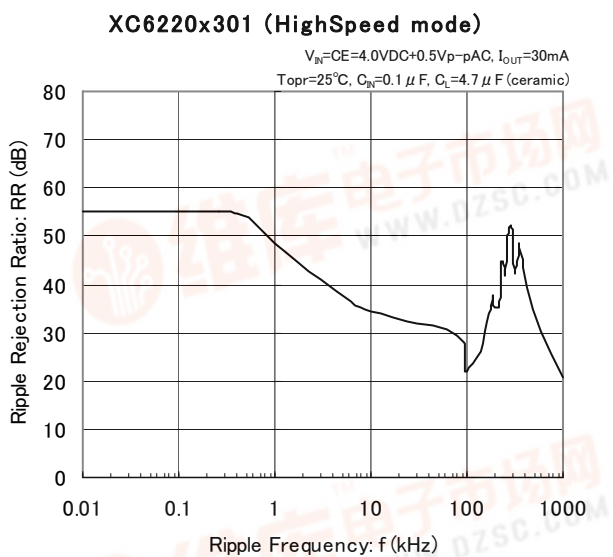

# XC6220 Series

[查询XC6220供应商](#)

## PACKAGING INFORMATION

### ● USP-6C

(unit : mm)

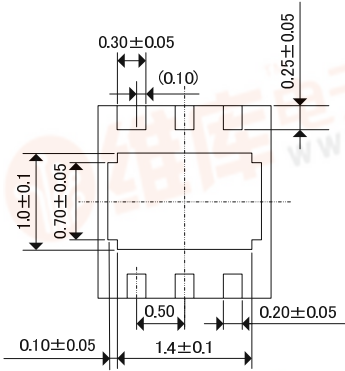
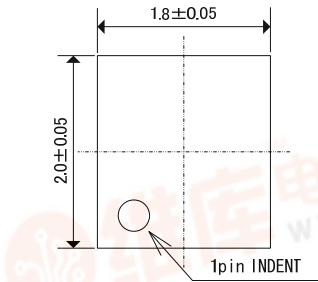

### ● SOT-25

(unit : mm)

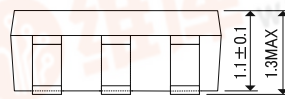
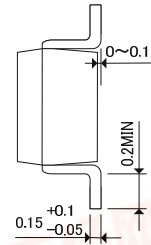
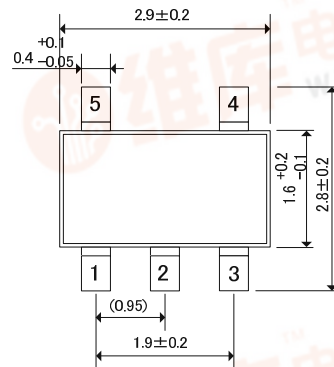

### ● SOT-89-5

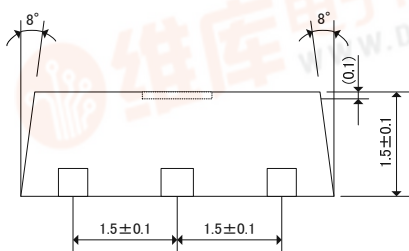
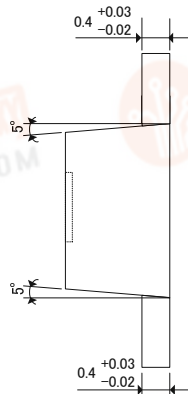
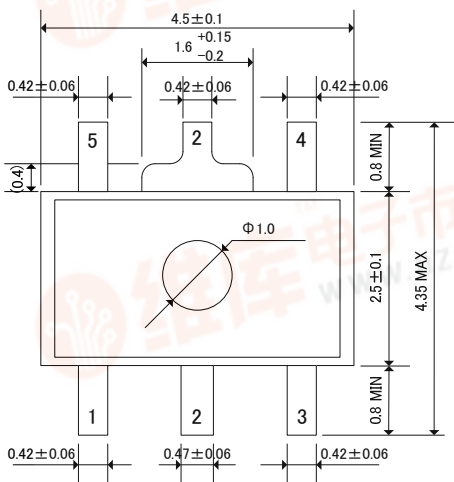



[查询XC6220供应商](#)

## ■ PACKAGING INFORMATION (Continued)

● USP-6C Reference Pattern Layout

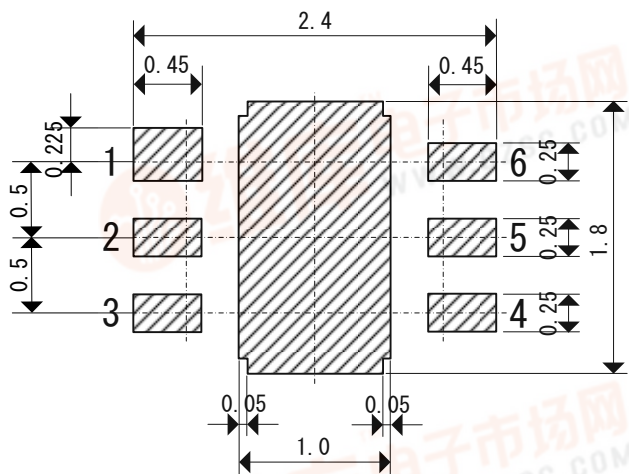

● USP-6C Reference Metal Mask Design

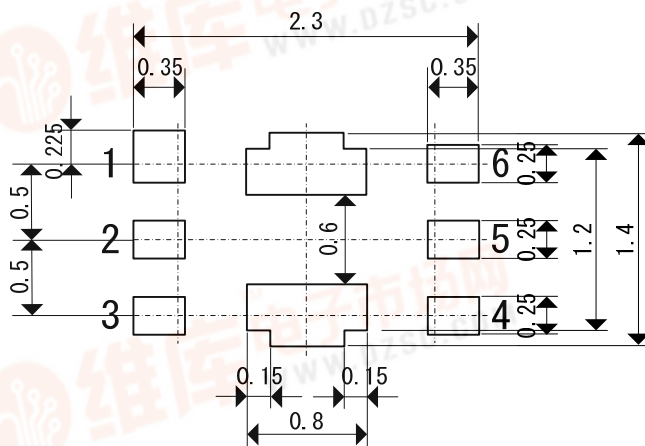

## PACKAGING INFORMATION (Continued)

### ● SOT-25 Power Dissipation

Power dissipation data for the SOT-25 is shown in this page.

The value of power dissipation varies with the mount board conditions.

Please use this data as one of reference data taken in the described condition.

#### 1. Measurement Condition (Reference data)

- Condition: Mount on a board
- Ambient: Natural convection
- Soldering: Lead (Pb) free
- Board: Dimensions 40 x 40 mm (1600 mm<sup>2</sup> in one side)  
Copper (Cu) traces occupy 50% of the board area  
In top and back faces  
Package heat-sink is tied to the copper traces  
(Board of SOT-26 is used.)
- Material: Glass Epoxy (FR-4)
- Thickness: 1.6 mm
- Through-hole: 4 x 0.8 Diameter

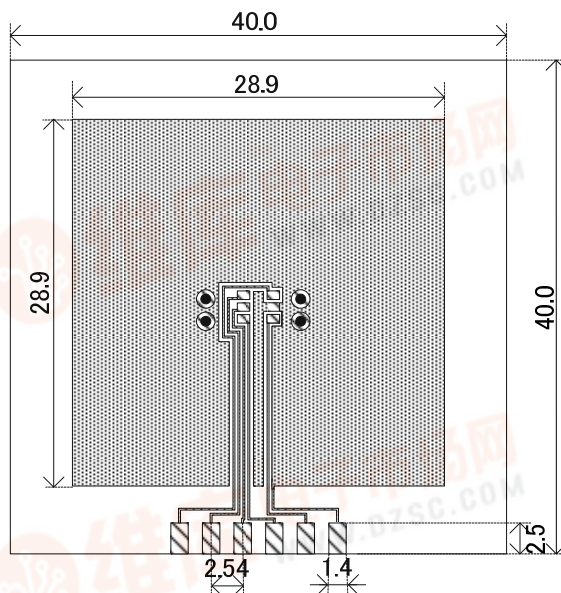

Evaluation Board (Unit: mm)

#### 2. Power Dissipation vs. Ambient temperature

Board Mount ( $T_j \text{ max} = 125^\circ\text{C}$ )

Ambient Temperature ( $^\circ\text{C}$ )	Power Dissipation $P_d$ (mW)	Thermal Resistance ( $^\circ\text{C/W}$ )
25	600	166.67
85	240	

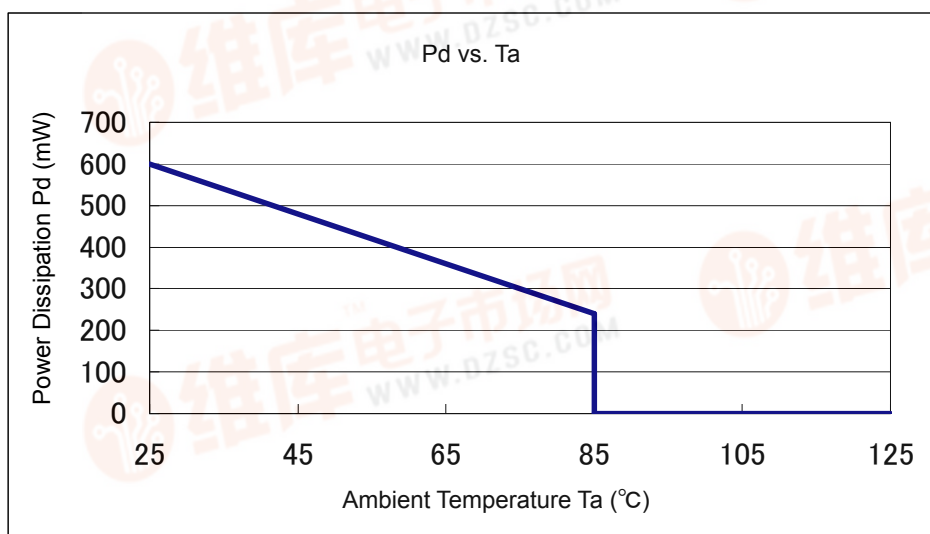

[查询XC6220供应商](#)

## ■ PACKAGING INFORMATION (Continued)

- SOT-89-5 Power Dissipation

Power dissipation data for the SOT-89-5 is shown in this page.

The value of power dissipation varies with the mount board conditions.

Please use this data as one of reference data taken in the described condition.

### 2. Measurement Condition (Reference data)

Condition: Mount on a board

Ambient: Natural convection

Soldering: Lead (Pb) free

Board: Dimensions 40 x 40 mm (1600 mm<sup>2</sup> in one side)

Copper (Cu) traces occupy 50% of the board area

In top and back faces

Package heat-sink is tied to the copper traces

Material: Glass Epoxy (FR-4)

Thickness: 1.6 mm

Through-hole: 5 x 0.8 Diameter

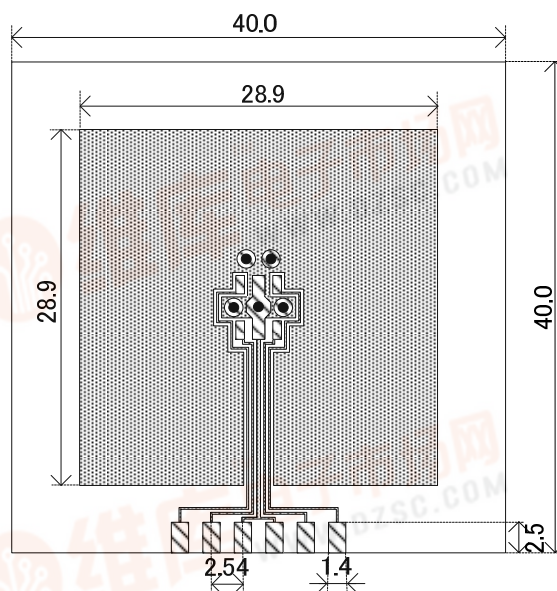

Evaluation Board (Unit: mm)

### 2. Power Dissipation vs. Ambient temperature

Board Mount ( $T_j \text{ max} = 125^\circ\text{C}$ )

Ambient Temperature ( $^\circ\text{C}$ )	Power Dissipation $P_d$ (mW)	Thermal Resistance ( $^\circ\text{C}/\text{W}$ )
25	1300	76.92
85	520	

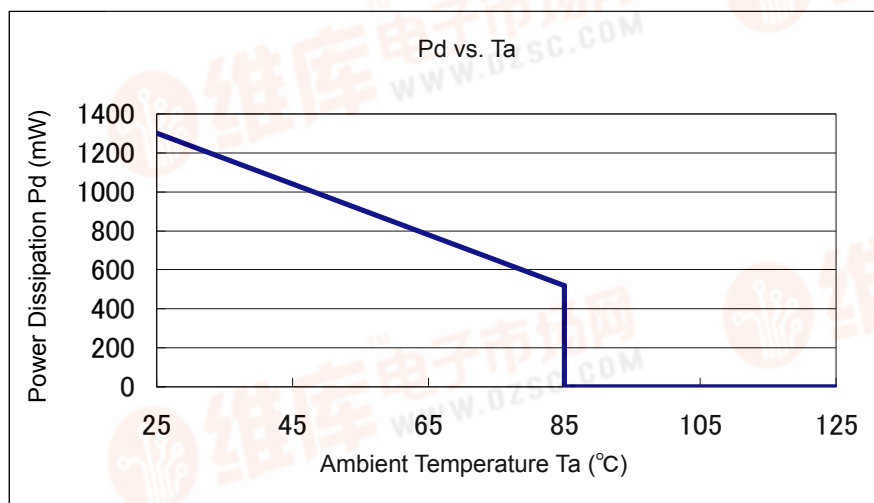

## PACKAGING INFORMATION (Continued)

- USP-6C Power Dissipation

Power dissipation data for the USP-6C is shown in this page.

The value of power dissipation varies with the mount board conditions.

Please use this data as one of reference data taken in the described condition.

### 3. Measurement Condition (Reference data)

- Condition: Mount on a board
- Ambient: Natural convection
- Soldering: Lead (Pb) free
- Board: Dimensions 40 x 40 mm (1600 mm<sup>2</sup> in one side)  
Copper (Cu) traces occupy 50% of the board area  
In top and back faces  
Package heat-sink is tied to the copper traces
- Material: Glass Epoxy (FR-4)
- Thickness: 1.6 mm
- Through-hole: 4 x 0.8 Diameter

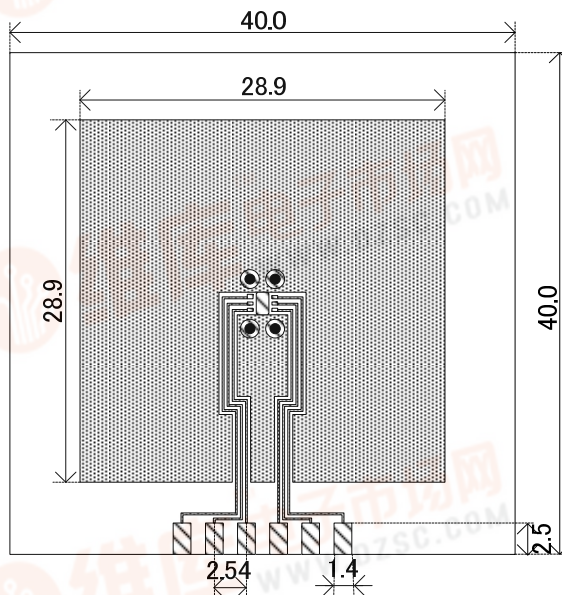

Evaluation Board (Unit: mm)

Board Mount ( $T_j$  max = 125°C)

Ambient Temperature (°C)	Power Dissipation Pd (mW)	Thermal Resistance (°C/W)
25	1000	100.00
85	400	

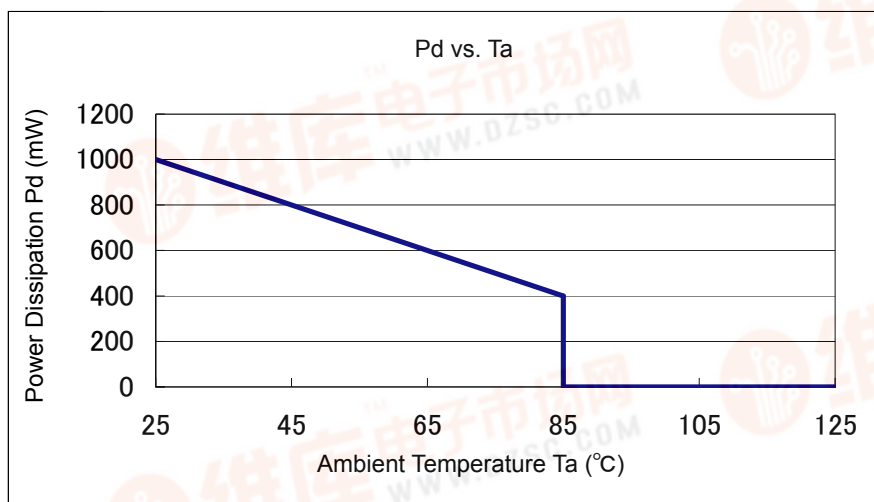

[查询XC6220供应商](#)

## MARKING RULE

● SOT-25, SOT-89-5

SOT25

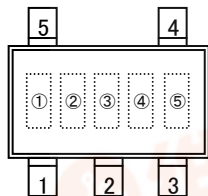

SOT89-5

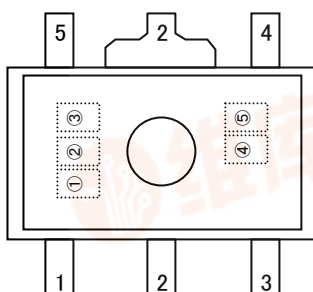

USP6C

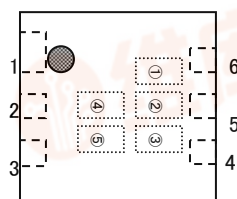

① represents product series

MARK	PRODUCT SERIES
H	XC6220*****

② represents type of CE, voltage range, and accuracy

MARK	CE	OUTPUT VOLTAGE RANGE	OUTPUT VOLTAGE ACCURACY	PRODUCT SERIES
0	A	0.8~2.9	1	XC6220A081** ~ XC6220A291**
1	A	0.8~2.9	B	XC6220A08B** ~ XC6220A29B**
2	A	3.0~5.0	1	XC6220A301** ~ XC6220A501**
3	A	3.0~4.9	B	XC6220A30B** ~ XC6220A49B**
4	B	0.8~2.9	1	XC6220B081** ~ XC6220B291**
5	B	0.8~2.9	B	XC6220B08B** ~ XC6220B29B**
6	B	3.0~5.0	1	XC6220B301** ~ XC6220B501**
7	B	3.0~4.9	B	XC6220B30B** ~ XC6220B49B**
8	C	0.8~2.9	1	XC6220C081** ~ XC6220C291**
9	C	0.8~2.9	B	XC6220C08B** ~ XC6220C29B**
A	C	3.0~5.0	1	XC6220C301** ~ XC6220C501**
B	C	3.0~4.9	B	XC6220C30B** ~ XC6220C49B**
C	D	0.8~2.9	1	XC6220D081** ~ XC6220D291**
D	D	0.8~2.9	B	XC6220D08B** ~ XC6220D29B**
E	D	3.0~5.0	1	XC6220D301** ~ XC6220D501**
F	D	3.0~4.9	B	XC6220D30B** ~ XC6220D49B**

\* Accuracy "1"···0.1V increments, Accuracy "B"···0.05V increments

③ represents output voltage

MARK	OUTPUT VOLTAGE (V)		MARK	OUTPUT VOLTAGE (V)		MARK	OUTPUT VOLTAGE (V)	
0	—	3.0x	A	1.0x	4.0x	N	2.0x	5.0x
1	—	3.1x	B	1.1x	4.1x	P	2.1x	—
2	—	3.2x	C	1.2x	4.2x	R	2.2x	—
3	—	3.3x	D	1.3x	4.3x	S	2.3x	—
4	—	3.4x	E	1.4x	4.4x	T	2.4x	—
5	—	3.5x	F	1.5x	4.5x	U	2.5x	—
6	—	3.6x	H	1.6x	4.6x	V	2.6x	—
7	—	3.7x	K	1.7x	4.7x	X	2.7x	—
8	0.8x	3.8x	L	1.8x	4.8x	Y	2.8x	—
9	0.9x	3.9x	M	1.9x	4.9x	Z	2.9x	—

④,⑤ represents production lot number  
01~09, 0A~0Z, 11···9Z, A1~A9, AA···Z9, ZA~ZZ repeated  
(G, I, J, O, Q, W excluded)  
\*No character inversion used.



1. The products and product specifications contained herein are subject to change without notice to improve performance characteristics. Consult us, or our representatives before use, to confirm that the information in this datasheet is up to date.
2. We assume no responsibility for any infringement of patents, patent rights, or other rights arising from the use of any information and circuitry in this datasheet.
3. Please ensure suitable shipping controls (including fail-safe designs and aging protection) are in force for equipment employing products listed in this datasheet.
4. The products in this datasheet are not developed, designed, or approved for use with such equipment whose failure or malfunction can be reasonably expected to directly endanger the life of, or cause significant injury to, the user.  
(e.g. Atomic energy; aerospace; transport; combustion and associated safety equipment thereof.)
5. Please use the products listed in this datasheet within the specified ranges. Should you wish to use the products under conditions exceeding the specifications, please consult us or our representatives.
6. We assume no responsibility for damage or loss due to abnormal use.
7. All rights reserved. No part of this datasheet may be copied or reproduced without the prior permission of TOREX SEMICONDUCTOR LTD.

**TOREX SEMICONDUCTOR LTD.**