

600mA Synchronous Step-Down DC/DC Converter + Low Voltage Input LDO

■ GENERAL DESCRIPTION

The XCM519 series is a multi combination module IC which comprises of a 600mA driver transistor built-in synchronous step-down DC/DC converter and a low voltage input LDO regulator. The device is housed in small USP-12B01 package which is ideally suited for space conscious applications. Battery operated portable products require high efficiency so that a dual DC/DC converter is often used. The XCM519 can replace this dual DC/DC to eliminate one inductor and reduce output noise. The DC/DC converter and the LDO regulator blocks are isolated in the package so that noise interference from the DC/DC to the LDO regulator is minimal.

A low output voltage and low On-resistance LDO regulator is added in series to the DC/DC output so that one another low output voltage is created with a high efficiency and low noise. With comparison to the dual DC/DC solution, one inductor can be eliminated which results in parts reduction and board space saving.

■ APPLICATIONS

- Mobile phones, Smart phones
- Bluetooth equipment
- Portable communication modems
- Portable game consoles

■ TYPICAL APPLICATION CIRCUIT

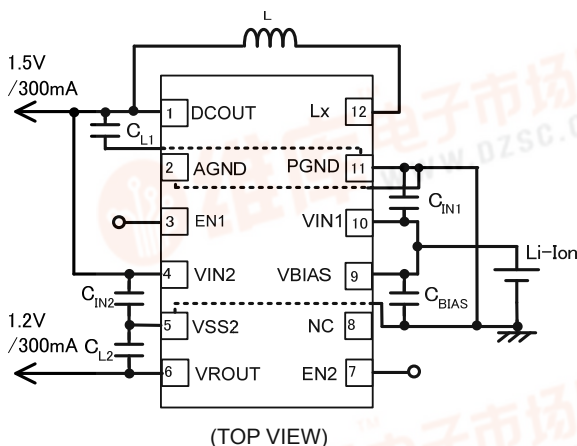

* The dashed lines denote the connection using through-holes at the backside of the PC board.

■ TYPICAL PERFORMANCE CHARACTERISTICS

Dropout Voltage vs. Output Current

$V_{ROUT}=1.2V$

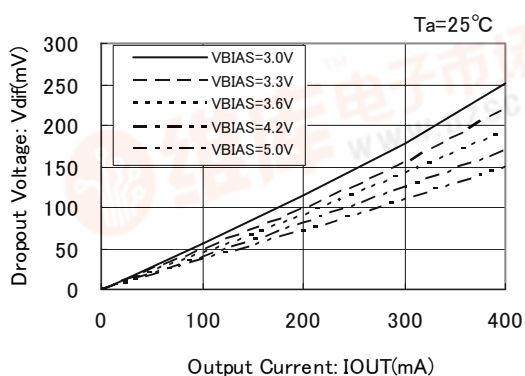

■ FEATURES

<DC/DC Converter Block>

- Input Voltage Range : 2.7V ~ 6.0V
- Output Voltage Range : 0.8V ~ 4.0V
- High Efficiency : 92% (TYP.)
- Output Current : 600mA (MAX.)
- Oscillation Frequency : 1.2MHz, 3.0MHz ($\pm 15\%$)
- Maximum Duty Cycle : 100%
- Soft-Start Circuit Built-In
- Current Limiter Circuit (Constant Current & Latching) Built-In
- Control Methods : PWM (XCM519A)
PWM/PFM Auto (XCM519B)

*Performance depends on external components and wiring on PCB wiring.

<Regulator Block>

- Maximum Output Current : 400mA (Limiter 550mA TYP.)
- Dropout Voltage : 35mV@ $I_{OUT}=100mA$ (TYP.)
(at $V_{BIAS} - V_{ROUT(E)}=2.4V$)
- Bias Voltage Range : 2.5V ~ 6.0V ($V_{BIAS} - V_{ROUT(E)}=0.9V$)
- Input Voltage Range : 1.0V ~ 3.0V ($V_{IN2} \leq V_{BIAS}$)
- Output Voltage Range : 0.7V ~ 1.8V (0.05V increments)
- High Output Accuracy : $\pm 20mV$
- Supply Current : $I_{BIAS}=25\mu A$, $I_{IN2}=1.0\mu A$ (TYP.)
- Stand-by Current : $I_{BIAS}=0.01\mu A$, $I_{IN2}=0.01\mu A$ (TYP.)
- UVLO : $V_{BIAS}=2.0V$, $V_{IN2}=0.4V$ (TYP.)
- Thermal Shut Down : Detect 150°C, Release 125°C (TYP.)
- Soft-start Time : 240 μs @ $V_{ROUT}=1.2V$ (TYP.)
- C_L High Speed Auto-Discharge

- Low ESR Capacitor : Ceramic Capacitor Compatible
- Operating Temperature Range : -40°C ~ +85°C
- Package : USP-12B01
- Environmentally Friendly : EU RoHS Compliant, Pb Free

| Standard Voltage Combinations : DC/DC | | VR |
|---------------------------------------|------|------|
| XCM519xx01Dx | 1.8V | 1.2V |
| XCM519xx02Dx | 1.8V | 1.5V |
| XCM519xx03Dx | 1.5V | 1.2V |
| XCM519xx04Dx | 1.8V | 1.0V |
| XCM519xx05Dx | 1.5V | 1.0V |

*Other combinations are available as semi-custom products.

XCM519 Series

查询XCM519供应商

PIN CONFIGURATION

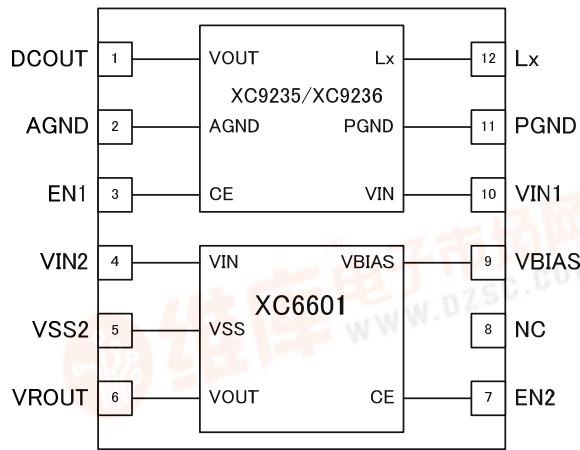

(TOP VIEW)

| PIN No. | XCM519 | XC9235/XC9236 | XC6601 |
|---------|------------|---------------|------------|
| 1 | DCOUT | V_{OUT} | — |
| 2 | AGND | AGND | — |
| 3 | EN1 | CE | — |
| 4 | V_{IN2} | — | V_{IN} |
| 5 | V_{SS2} | — | V_{SS} |
| 6 | VROUT | — | V_{OUT} |
| 7 | EN2 | — | CE |
| 8 | NC | — | — |
| 9 | V_{BIAS} | — | V_{BIAS} |
| 10 | V_{IN1} | V_{IN} | — |
| 11 | PGND | PGND | — |
| 12 | Lx | Lx | — |

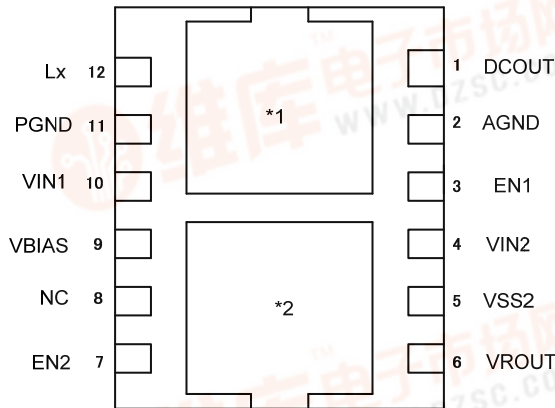

(BOTTOM VIEW)

NOTE:

* The DC/DC ground pin (No. 2 and 11) should be connected for use.

* A dissipation pad on the reverse side of the package should be electrically isolated.

*1: Electrical potential of the XC9235/XC9236's dissipation pad should be V_{SS} level.

*2: Electrical potential of the XC6601's dissipation pad should be V_{SS} level.

Care must be taken for an electrical potential of each dissipation pad so as to enhance mounting strength and heat release when the pad needs to be connected to the circuit.

PIN ASSIGNMENT

| PIN No. | XCM519 | FUNCTIONS |
|---------|------------|--------------------------------------|
| 1 | DCOUT | DC/DC Block: Output Voltage |
| 2 | AGND | DC/DC Block: Analog Ground |
| 3 | EN1 | DC/DC Block: Chip Enable |
| 4 | V_{IN2} | Voltage Regulator Block: Power Input |
| 5 | V_{SS2} | Voltage Regulator Block: Ground |
| 6 | VROUT | Voltage Regulator Block: Output |
| 7 | EN2 | Voltage Regulator Block: Enable |
| 8 | NC | No Connection |
| 9 | V_{BIAS} | Voltage Regulator Block: Power Input |
| 10 | V_{IN1} | DC/DC Block: Power Input |
| 11 | PGND | DC/DC Block: Power Ground |
| 12 | Lx | DC/DC Block: Switching |

[查询XCM519供应商](#)

■PRODUCT CLASSIFICATION

●Ordering Information

XCM519A①②③④⑤ DC/DC BLOCK : PWM fixed control

XCM519B①②③④⑤ DC/DC BLOCK : PWM/PFM automatic switching control

| DESIGNATOR | DESCRIPTION | SYMBOL | DESCRIPTION |
|------------|-----------------------------------|--------|--|
| ① | Oscillation Frequency and Options | — | See the chart below |
| ② ③ | Output Voltage | — | Internally set sequential number relating to output voltage (See the chart below) |
| ④ | Package | D | USP-12B01 |
| ⑤ | Device Orientation | R | Embossed tape, standard feed |

●DESIGNATOR①

| ① | DC/DC BLOCK | | | Voltage Regulator BLOCK |
|---|--------------------------|----------------------------------|------------|-------------------------|
| | OSCILLATION FREQUENCY | C _L AUTO DISCHARGE | SOFT START | Pull-down |
| A | 1.2M | Not Available | Standard | Not Available |
| B | 3.0M | Not Available | Standard | Not Available |
| C | 1.2M | Available | High Speed | Not Available |
| D | 3.0M | Available | High Speed | Not Available |

●DESIGNATOR②③

| ②③ | DCOUT | VROUT |
|----|-------|-------|
| 01 | 1.8V | 1.2V |
| 02 | 1.8V | 1.5V |
| 03 | 1.5V | 1.2V |
| 04 | 1.8V | 1.0V |
| 05 | 1.5V | 1.0V |

*When the DCOUT pin is connected to V_{IN2}, DCOUT pin output voltage can be fixed in the range of 1.0V~3.0V.

*This series are semi-custom products. For other combinations of output voltages please consult with your Torex sales contact.

XCM519 Series

查询XCM519供应商

BLOCK DIAGRAMS

XC9235A/XC9236A

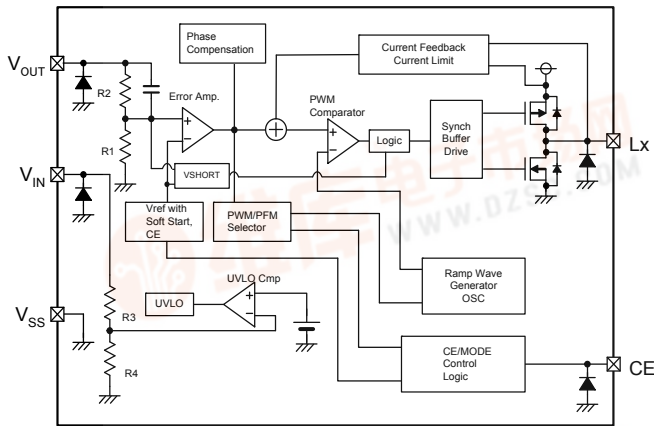

XC9235B/XC9236B

Available with C_L Discharge, High Speed Soft-Start

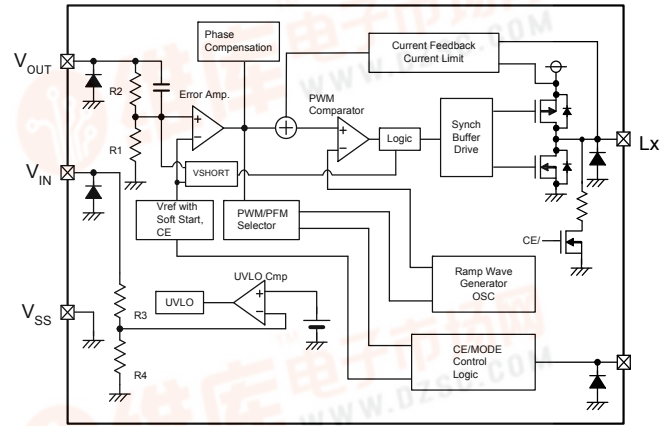

XC6601B (Without Pull-down)

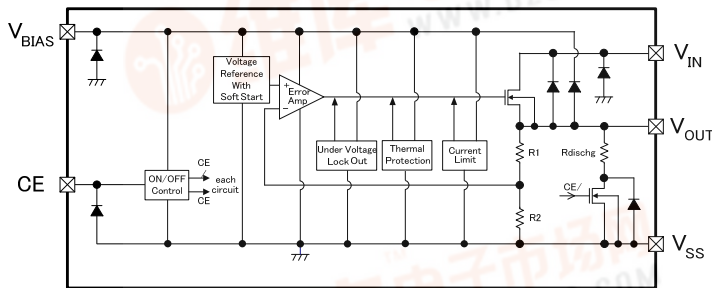

- * XC9235 control scheme is a fixed PWM because that the "CE/MODE Control Logic" outputs a low level signal to the "PWM/PFM Selector".
- * XC9236 control scheme is an auto PWM/PFM switching because the "CE/MODE Control Logic" outputs a high level signal to the "PWM/PFM Selector".
- * Diodes inside the circuit are an ESD protection diode and a parasitic diode.

MAXIMUM ABSOLUTE RATINGS

T_a=25°C

| PARAMETER | SYMBOL | RATINGS | UNITS |
|---|-----------------------------|---|-------|
| V _{IN1} Voltage | V _{IN1} | - 0.3 ~ 6.5 | V |
| Lx Voltage | V _{Lx} | - 0.3 ~ V _{IN1} + 0.3 or 6.5 | V |
| DCOUT Voltage | V _{DCOUT} | - 0.3 ~ 6.5 | V |
| EN1 Voltage | V _{EN1} | - 0.3 ~ 6.5 | V |
| Lx Current | I _{Lx} | ±1500 | mA |
| V _{BIAS} Voltage | V _{BIAS} | V _{SS} - 0.3 ~ 7.0 | V |
| V _{IN2} Voltage | V _{IN2} | V _{SS} - 0.3 ~ 7.0 | V |
| V _{ROUT} Current | I _{VROUT} | 700 ⁽¹⁾ | mA |
| V _{ROUT} Voltage | V _{ROUT} | V _{SS} - 0.3 ~ V _{BIAS} + 0.3 | V |
| | | V _{SS} - 0.3 ~ V _{IN2} + 0.3 | |
| EN2 Voltage | V _{EN2} | V _{SS} - 0.3 ~ 6.5 | V |
| Power Dissipation (T _a =25°C) | USP-12B01 P _d | 150 | mW |
| Junction Temperature | T _j | 125 | °C |
| Operating Temperature Range | T _{opr} | -40 ~ +85 | °C |
| Storage Temperature Range | T _{stg} | -55 ~ +125 | °C |

⁽¹⁾ I_{VROUT}=Less than P_d / (V_{IN2}-V_{ROUT})



查询XCM519供应商

ELECTRICAL CHARACTERISTICS

●XCM519xA (DC/DC BLOCK)

$V_{DCOUT}=1.8V$, $f_{OSC}=1.2MHz$, $T_a=25^{\circ}C$

| PARAMETER | SYMBOL | CONDITIONS | MIN. | TYP. | MAX. | UNITS | CIRCUIT | |
|--|---|---|------------|-----------|-------|------------------|---------|---|
| Output Voltage | V_{DCOUT} | When connected to external components, $V_{IN1}=V_{EN1}=5.0V$, $I_{OUT1}=30mA$ | 1.764 | 1.800 | 1.836 | V | ① | |
| Operating Voltage Range | V_{IN1} | | 2.7 | - | 6.0 | V | ① | |
| Maximum Output Current | $I_{OUT1MAX}$ | When connected to external components, $V_{IN1}=DCOUT(E)+2.0V$, $V_{EN1}=1.0V$ ⁽⁸⁾ | 600 | - | - | mA | ① | |
| UVLO Voltage | V_{UVLO} | $V_{EN1}=V_{IN1}$, $DCOUT=0V$, Voltage which Lx pin holding "L" level ^{(1), (10)} | 1.00 | 1.40 | 1.78 | V | ③ | |
| Supply Current | I_{DD} | $V_{IN1}=V_{EN1}=5.0V$, $DCOUT=DCOUT(E)\times 1.1V$ | (XCM519AA) | - | 22 | 50 | ② | - |
| | | | (XCM519BA) | - | 15 | 33 | | |
| Stand-by Current | I_{STB} | $V_{IN1}=5.0V$, $V_{EN1}=0V$, $DCOUT=DCOUT(E)\times 1.1V$ | - | 0 | 1.0 | μA | ② | |
| Oscillation Frequency | f_{OSC} | When connected to external components, $V_{IN1}=DCOUT(E)+2.0V$, $V_{EN1}=1.0V$, $I_{OUT1}=100mA$ ⁽¹¹⁾ | 1020 | 1200 | 1380 | kHz | ① | |
| PFM Switching Current | I_{PFM} | When connected to external components, $V_{IN1}=V_{DCOUT(E)}+2.0V$, $V_{EN1}=V_{IN1}$, $I_{OUT1}=1mA$ ⁽¹¹⁾ | 120 | 160 | 200 | mA | ① | |
| PFM Duty Limit | D_{LIMIT_PFM} | $V_{EN1}=V_{IN1}=(C-1)$, $I_{OUT1}=1mA$ ⁽¹¹⁾ | - | 200 | - | % | ① | |
| Maximum Duty Ratio | D_{MAX} | $V_{IN1}=V_{EN1}=5.0V$, $DCOUT=DCOUT(E)\times 0.9V$ | 100 | - | - | % | ② | |
| Minimum Duty Ratio | D_{MIN} | $V_{IN1}=V_{EN1}=5.0V$, $DCOUT=DCOUT(E)\times 1.1V$ | - | - | 0 | % | ② | |
| Efficiency ⁽²⁾ | EFFI | When connected to external components, $V_{EN1}=V_{IN1}=DCOUT(E)+1.2V$ ⁽⁷⁾ , $I_{OUT1}=100mA$ | - | 92 | - | % | ① | |
| Lx SW "H" ON Resistance 1 | R_{LXH} | $V_{IN1}=V_{EN1}=5.0V$, $DCOUT=0V$, $I_{LX}=100mA$ ⁽³⁾ | - | 0.35 | 0.55 | Ω | ④ | |
| Lx SW "H" ON Resistance 2 | R_{LXH} | $V_{IN1}=V_{EN1}=3.6V$, $DCOUT=0V$, $I_{LX}=100mA$ ⁽³⁾ | - | 0.42 | 0.67 | Ω | ④ | |
| Lx SW "L" ON Resistance 1 | R_{LXL} | $V_{IN1}=V_{EN1}=5.0V$ ⁽⁴⁾ | - | 0.45 | 0.66 | Ω | - | |
| Lx SW "L" ON Resistance 2 | R_{LXL} | $V_{IN1}=V_{EN1}=3.6V$ ⁽⁴⁾ | - | 0.52 | 0.77 | Ω | - | |
| Lx SW "H" Leak Current ⁽⁵⁾ | I_{LEAKH} | $V_{IN1}=DCOUT=5.0V$, $V_{EN1}=0V$, $V_{LX}=0V$ | - | 0.01 | 1.0 | μA | ⑤ | |
| Lx SW "L" Leak Current ⁽⁵⁾ | I_{LEAKL} | $V_{IN1}=DCOUT=5.0V$, $V_{EN1}=0V$, $V_{LX}=5.0V$ | - | 0.01 | 1.0 | μA | ⑤ | |
| Current Limit ⁽⁹⁾ | I_{LIM} | $V_{IN1}=V_{EN1}=5.0V$, $DCOUT=DCOUT(E)\times 0.9V$ | 900 | 1050 | 1350 | mA | ⑥ | |
| Output Voltage Temperature Characteristics | $\Delta DCOUT / (DCOUT \cdot \Delta T_{opr})$ | $I_{OUT1}=30mA$ $-40^{\circ}C \leq T_{opr} \leq 85^{\circ}C$ | - | ± 100 | - | ppm/ $^{\circ}C$ | ① | |
| EN1 "H" Level Voltage | V_{EN1H} | $DCOUT=0V$, Applied voltage to V_{EN} , Voltage changes Lx to "H" level ⁽¹⁰⁾ | 0.65 | - | 6.0 | V | ③ | |
| EN1 "L" Level Voltage | V_{EN1L} | $DCOUT=0V$, Applied voltage to V_{EN} , Voltage changes Lx to "L" level ⁽¹⁰⁾ | V_{SS} | - | 0.25 | V | ③ | |
| EN1 "H" Current | I_{EN1H} | $V_{IN1}=V_{EN1}=5.0V$, $DCOUT=0V$ | -0.1 | - | 0.1 | μA | ⑤ | |
| EN1 "L" Current | I_{EN1L} | $V_{IN1}=5.0V$, $V_{EN1}=0V$, $DCOUT=0V$ | -0.1 | - | 0.1 | μA | ⑤ | |
| Soft Start Time | t_{SS} | When connected to external components, $V_{EN1}=0V \rightarrow V_{IN1}$, $I_{OUT1}=1mA$ | 0.5 | 1.0 | 2.5 | ms | ① | |
| Latch Time | t_{LAT} | $V_{IN}=V_{EN}=5.0V$, $DCOUT=0.8 \times DCOUT(E)$ Short Lx at 1Ω resistance ⁽⁶⁾ | 1.0 | - | 20.0 | ms | ⑦ | |
| Short Protection Threshold Voltage | V_{SHORT} | Sweeping $DCOUT$, $V_{IN1}=V_{EN1}=5.0V$, Short Lx at 1Ω resistance, $DCOUT$ voltage which Lx becomes "L" level within 1ms | 0.675 | 0.900 | 1.125 | V | ⑦ | |

Test conditions: Unless otherwise stated, $V_{IN}=5.0V$, $V_{DCOUT(E)}$ = Setting voltage

NOTE:

*1: Including hysteresis width of operating voltage.

*2: $EFFI = \{ (\text{output voltage} \times \text{output current}) / (\text{input voltage} \times \text{input current}) \} \times 100$

*3: ON resistance (Ω)= $(V_{IN} - \text{Lx pin measurement voltage}) / 100mA$

*4: Design value

*5: When temperature is high, a current of approximately $10 \mu A$ (maximum) may leak.

*6: Time until it short-circuits $DCOUT$ with GND via 1Ω of resistor from an operational state and is set to $Lx=0V$ from current limit pulse generating.

*7: $V_{DCOUT(E)}+1.2V < 2.7V$, $V_{IN}=2.7V$.

*8: When the difference between the input and the output is small, some cycles may be skipped completely before current maximizes. If current is further pulled from this state, output voltage will decrease because of P-ch driver ON resistance.

*9: Current limit denotes the level of detection at peak of coil current.

*10: "H"= $V_{IN} \sim V_{IN} - 1.2V$, "L"= $+0.1V \sim -0.1V$

*11: XCM519A series exclude I_{PFM} and $MAXI_{PFM}$ because those are only for the PFM control's functions.

* The electrical characteristics above are when the other channel is in stop mode.



XCM519 Series

查询XCM519供应商

ELECTRICAL CHARACTERISTICS (Continued)

●XCM519xB 1ch (DC/DC BLOCK)

$V_{DCOUT}=1.8V$, $f_{OSC}=3.0MHz$, $T_a=25^{\circ}C$

| PARAMETER | SYMBOL | CONDITIONS | MIN. | TYP. | MAX. | UNITS | CIRCUIT | |
|--|---|---|------------|-----------|-------|------------------|---------|---|
| Output Voltage | V_{DCOUT} | When connected to external components, $V_{IN1} = V_{EN1} = 5.0V$, $I_{OUT1} = 30mA$ | 1.764 | 1.800 | 1.836 | V | ① | |
| Operating Voltage Range | V_{IN1} | | 2.7 | - | 6.0 | V | ① | |
| Maximum Output Current | $I_{OUT1MAX}$ | When connected to external components, $V_{IN1}=V_{DCOUT(E)}+2.0V$, $V_{EN1}=1.0V$ ⁽⁸⁾ | 600 | - | - | mA | ① | |
| UVLO Voltage | V_{UVLO} | $V_{EN1}=V_{IN1}$, $DCOUT=0V$, Voltage which Lx pin holding "L" level ^(1, *10) | 1.00 | 1.40 | 1.78 | V | ③ | |
| Supply Current | I_{DD} | $V_{IN1}=V_{EN1}=5.0V$, $DCOUT=DCOUT(E) \times 1.1V$ | (XCM519AB) | - | 46 | 65 | ② | - |
| | | | (XCM519BB) | - | 21 | 35 | | |
| Stand-by Current | I_{STB} | $V_{IN1}=5.0V$, $V_{EN1}=0V$, $DCOUT=DCOUT(E) \times 1.1V$ | - | 0 | 1.0 | μA | ② | |
| Oscillation Frequency | f_{OSC} | When connected to external components, $V_{IN1}=DCOUT(E) + 2.0V$, $V_{EN1}=1.0V$, $I_{OUT1}=100mA$ | 2550 | 3000 | 3450 | kHz | ① | |
| PFM Switching Current | I_{PFM} | When connected to external components, $V_{IN1}=DCOUT(E) + 2.0V$, $V_{EN1}=V_{IN1}$, $I_{OUT1}=1mA$ ⁽¹¹⁾ | 170 | 220 | 270 | mA | ① | |
| PFM Duty Limit | D_{LIMIT_PFM} | $V_{EN1}=V_{IN1}=(C-1) I_{OUT1}=1mA$ ⁽¹¹⁾ | - | 200 | 300 | % | ① | |
| Maximum Duty Ratio | D_{MAX} | $V_{IN1}=V_{EN1} = 5.0V$, $DCOUT=DCOUT(E) \times 0.9V$ | 100 | - | - | % | ② | |
| Minimum Duty Ratio | D_{MIN} | $V_{IN1}=V_{EN1} = 5.0V$, $DCOUT=DCOUT(E) \times 1.1V$ | - | - | 0 | % | ② | |
| Efficiency | EFFI | When connected to external components, $V_{EN1}=V_{IN1}=DCOUT(E) + 1.2V$, $I_{OUT1} = 100mA$ | - | 86 | - | % | ① | |
| Lx SW "H" ON Resistance 1 | R_{LXH} | $V_{IN1} = V_{EN1} = 5.0V$, $DCOUT=0V$, $I_{LX}=100mA$ ⁽³⁾ | - | 0.35 | 0.55 | Ω | ④ | |
| Lx SW "H" ON Resistance 2 | R_{LXH} | $V_{IN1} = V_{EN1} = 3.6V$, $DCOUT=0V$, $I_{LX}=100mA$ ⁽³⁾ | - | 0.42 | 0.67 | Ω | ④ | |
| Lx SW "L" ON Resistance 1 | R_{LXL} | $V_{IN1} = V_{EN1} = 5.0V$ ⁽⁴⁾ | - | 0.45 | 0.66 | Ω | - | |
| Lx SW "L" ON Resistance 2 | R_{LXL} | $V_{IN1} = V_{EN1} = 3.6V$ ⁽⁴⁾ | - | 0.52 | 0.77 | Ω | - | |
| Lx SW "H" Leak Current ⁽⁵⁾ | I_{LEAKH} | $V_{IN1} = DCOUT=5.0V$, $V_{EN1} = 0V$, $V_{LX}=0V$ | - | 0.01 | 1.0 | μA | ⑤ | |
| Lx SW "L" Leak Current ⁽⁵⁾ | I_{LEAKL} | $V_{IN1} = DCOUT=5.0V$, $V_{EN1} = 0V$, $V_{LX}=5.0V$ | - | 0.01 | 1.0 | μA | ⑤ | |
| Current Limit ⁽⁹⁾ | I_{LIM} | $V_{IN1}=V_{EN1}=5.0V$, $DCOUT=DCOUT(E) \times 0.9V$ | 900 | 1050 | 1350 | mA | ⑥ | |
| Output Voltage Temperature Characteristics | $\Delta DCOUT / (DCOUT \cdot \Delta T_{opr})$ | $I_{OUT1} = 30mA$ $-40^{\circ}C \leq T_{opr} \leq 85^{\circ}C$ | - | ± 100 | - | ppm/ $^{\circ}C$ | ① | |
| EN1 "H" Level Voltage | V_{EN1H} | $DCOUT=0V$, Applied voltage to V_{EN} , Voltage changes Lx to "H" level ⁽¹⁰⁾ | 0.65 | - | 6.0 | V | ③ | |
| EN1 "L" Level Voltage | V_{EN1L} | $DCOUT=0V$, Applied voltage to V_{EN} , Voltage changes Lx to "L" level ⁽¹⁰⁾ | V_{SS} | - | 0.25 | V | ③ | |
| EN1 "H" Current | I_{EN1H} | $V_{IN1}=V_{EN1}=5.0V$, $DCOUT=0V$ | - 0.1 | - | 0.1 | μA | ⑤ | |
| EN1 "L" Current | I_{EN1L} | $V_{IN1}=5.0V$, $V_{EN1} = 0V$, $DCOUT=0V$ | - 0.1 | - | 0.1 | μA | ⑤ | |
| Soft Start Time | t_{SS} | When connected to external components, $V_{EN1} = 0V \rightarrow V_{IN1}$, $I_{OUT1}=1mA$ | 0.5 | 0.9 | 2.5 | ms | ① | |
| Latch Time | t_{LAT} | $V_{IN1}=V_{EN1}=5.0V$, $DCOUT=0.8 \times DCOUT(E)$ Short Lx at 1Ω resistance ⁽⁶⁾ | 1.0 | - | 20 | ms | ⑦ | |
| Short Protection Threshold Voltage | V_{SHORT} | Sweeping $DCOUT$, $V_{IN1}=V_{EN1}=5.0V$, Short Lx at 1Ω resistance, $DCOUT$ voltage which Lx becomes "L" level within 1ms | 0.675 | 0.900 | 1.125 | V | ⑦ | |

Test conditions: Unless otherwise stated, $V_{IN1}=5.0V$, $V_{DCOUT(E)}$ = Nominal voltage

NOTE:

- *1: Including hysteresis width of operating voltage.
- *2: $EFFI = \{ (\text{output voltage} \times \text{output current}) / (\text{input voltage} \times \text{input current}) \} \times 100$
- *3: ON resistance (Ω)= $(V_{IN} - Lx \text{ pin measurement voltage}) / 100mA$
- *4: Design value
- *5: When temperature is high, a current of approximately $10 \mu A$ (maximum) may leak.
- *6: Time until it short-circuits $DCOUT$ with GND via 1Ω of resistor from an operational state and is set to $Lx=0V$ from current limit pulse generating.
- *7: $V_{DCOUT(E)}+1.2V < 2.7V$, $V_{IN}=2.7V$.
- *8: When the difference between the input and the output is small, some cycles may be skipped completely before current maximizes.
If current is further pulled from this state, output voltage will decrease because of P-ch driver ON resistance.
- *9: Current limit denotes the level of detection at peak of coil current.
- *10: "H"= $V_{IN} \sim V_{IN} - 1.2V$, "L"= $+ 0.1V \sim - 0.1V$
- *11: XCM519A series exclude I_{PFM} and D_{LIMIT_PFM} because those are only for the PFM control's functions.
- * The electrical characteristics above are when the other channel is in stop mode.

查询XCM519供应商

ELECTRICAL CHARACTERISTICS (Continued)

●XCM519xC 1ch (DC/DC BLOCK)

$V_{DCOUT}=1.8V, f_{OSC}=1.2MHz, T_a=25^{\circ}C$

| PARAMETER | SYMBOL | CONDITIONS | MIN. | TYP. | MAX. | UNITS | CIRCUIT | |
|--|---|--|------------|-----------|-------|------------------|---------|---|
| Output Voltage | V_{DCOUT} | When connected to external components, $V_{IN1}=V_{EN1}=5.0V, I_{OUT1}=30mA$ | 1.764 | 1.800 | 1.836 | V | ① | |
| Operating Voltage Range | V_{IN1} | | 2.7 | - | 6.0 | V | ① | |
| Maximum Output Current | $I_{OUT1MAX}$ | When connected to external components, $V_{IN1}=DCOUT(E)V+2.0V, V_{EN1}=1.0V$ ^(*8) | 600 | - | - | mA | ① | |
| UVLO Voltage | V_{UVLO} | $V_{EN1}=V_{IN1}, DCOUT=0V$, Voltage which Lx pin holding "L" level ^(*1, *10) | 1.00 | 1.40 | 1.78 | V | ② | |
| Supply Current | I_{DD} | $V_{IN1}=V_{EN1}=5.0V, DCOUT=DCOUT(E)\times 1.1V$ | (XCM519AC) | - | 22 | 50 | μA | ③ |
| | | | (XCM519BC) | - | 15 | 33 | | |
| Stand-by Current | I_{STB} | $V_{IN1}=5.0V, V_{EN1}=0V, DCOUT=DCOUT(E)\times 1.1V$ | - | 0 | 1.0 | μA | ③ | |
| Oscillation Frequency | f_{OSC} | When connected to external components, $V_{IN1}=DCOUT(E)V+2.0V, V_{EN1}=1.0V, I_{OUT1}=100mA$ | 1020 | 1200 | 1380 | kHz | ① | |
| PFM Switching Current | I_{PFM} | When connected to external components, $V_{IN1}=DCOUT(E)V+2.0V, V_{EN1}=V_{IN1}, I_{OUT1}=1mA$ ^(*11) | 120 | 160 | 200 | mA | ① | |
| PFM Duty Limit | D_{LIMIT_PFM} | $V_{EN1}=V_{IN1}=(C-1)I_{OUT1}=1mA$ ^(*11) | - | 200 | - | % | ② | |
| Maximum Duty Ratio | D_{MAX} | $V_{IN1}=V_{EN1}=5.0V, DCOUT=DCOUT(E)\times 0.9V$ | 100 | - | - | % | ② | |
| Minimum Duty Ratio | D_{MIN} | $V_{IN1}=V_{EN1}=5.0V, DCOUT=DCOUT(E)\times 1.1V$ | - | - | 0 | % | ② | |
| Efficiency | EFFI | When connected to external components, $V_{EN1}=V_{IN1}=DCOUT(E)+1.2V$ ^(*7) , $I_{OUT1}=100mA$ | - | 92 | - | % | ① | |
| Lx SW "H" ON Resistance 1 | RL_{XH} | $V_{IN1}=V_{EN1}=5.0V, DCOUT=0V, I_{LX}=100mA$ ^(*3) | - | 0.35 | 0.55 | Ω | ④ | |
| Lx SW "H" ON Resistance 2 | RL_{XH} | $V_{IN1}=V_{EN1}=3.6V, DCOUT=0V, I_{LX}=100mA$ ^(*3) | - | 0.42 | 0.67 | Ω | ④ | |
| Lx SW "L" ON Resistance 1 | RL_{XL} | $V_{IN1}=V_{EN1}=5.0V$ ^(*4) | - | 0.45 | 0.66 | Ω | - | |
| Lx SW "L" ON Resistance 2 | RL_{XL} | $V_{IN1}=V_{EN1}=3.6V$ ^(*4) | - | 0.52 | 0.77 | Ω | - | |
| Lx SW "H" Leak Current ^(*5) | I_{LEAKH} | $V_{IN1}=DCOUT=5.0V, V_{EN1}=0V, Lx=0V$ | - | 0.01 | 1.0 | μA | ⑨ | |
| Current Limit ^(*9) | I_{LIM} | $V_{IN1}=V_{EN1}=5.0V, DCOUT=DCOUT(E)\times 0.9V$ | 900 | 1050 | 1350 | mA | ⑥ | |
| Output Voltage Temperature Characteristics | $\Delta DCOUT / (DCOUT \cdot \Delta T_{opr})$ | $I_{OUT1}=30mA, -40^{\circ}C \leq T_{opr} \leq 85^{\circ}C$ | - | ± 100 | - | ppm/ $^{\circ}C$ | ① | |
| EN1 "H" Level Voltage | V_{EN1H} | $DCOUT=0V$, Applied voltage to V_{EN1} , Voltage changes Lx to "H" level ^(*10) | 0.65 | - | 6.0 | V | ③ | |
| EN1 "L" Level Voltage | V_{EN1L} | $DCOUT=0V$, Applied voltage to V_{EN1} , Voltage changes Lx to "L" level ^(*10) | V_{SS} | - | 0.25 | V | ③ | |
| EN1 "H" Current | I_{EN1H} | $V_{IN1}=V_{EN1}=5.0V, DCOUT=0V$ | - 0.1 | - | 0.1 | μA | ⑤ | |
| EN1 "L" Current | I_{EN1L} | $V_{IN1}=5.0V, V_{EN1}=0V, DCOUT=0V$ | - 0.1 | - | 0.1 | μA | ⑤ | |
| Soft Start Time | t_{SS} | When connected to external components, $V_{EN1}=0V \rightarrow V_{IN1}, I_{OUT1}=1mA$ | - | 0.25 | 0.40 | ms | ① | |
| Latch Time | T_{LAT} | $V_{IN1}=V_{EN1}=5.0V, DCOUT=0.8 \times DCOUT(E)$ Short Lx at 1Ω resistance ^(*6) | 1.0 | - | 20 | ms | ⑦ | |
| Short Protection Threshold Voltage | V_{SHORT} | Sweeping $DCOUT, V_{IN1}=V_{EN1}=5.0V$, Short Lx at 1Ω resistance, $DCOUT$ voltage which Lx becomes "L" level within 1ms | 0.675 | 0.900 | 1.150 | V | ⑦ | |
| C_L Discharge | R_{DCHG} | $V_{IN1}=5.0V, Lx=5.0V, V_{EN1}=0V, DCOUT=Open$ | 200 | 300 | 450 | Ω | ⑧ | |

Test conditions: Unless otherwise stated, $V_{IN1}=5.0V, V_{DCOUT(E)}$ = Nominal voltage

NOTE:

- *1: Including hysteresis width of operating voltage.
- *2: $EFFI = \{ (output\ voltage \times output\ current) / (input\ voltage \times input\ current) \} \times 100$
- *3: ON resistance (Ω) = $(V_{IN} - Lx\ pin\ measurement\ voltage) / 100mA$
- *4: Design value
- *5: When temperature is high, a current of approximately 10 μA (maximum) may leak.
- *6: Time until it short-circuits $DCOUT$ with GND via 1Ω of resistor from an operational state and is set to $Lx=0V$ from current limit pulse generating.
- *7: $V_{DCOUT(E)}+1.2V < 2.7V, V_{IN}=2.7V$.
- *8: When the difference between the input and the output is small, some cycles may be skipped completely before current maximizes. If current is further pulled from this state, output voltage will decrease because of P-ch driver ON resistance.
- *9: Current limit denotes the level of detection at peak of coil current.
- *10: "H" = $V_{IN} \sim V_{IN} - 1.2V$, "L" = $+ 0.1V \sim - 0.1V$
- *11: XCM519A series exclude I_{PFM} and D_{LIMIT_PFM} because those are only for the PFM control's functions.

* The electrical characteristics above are when the other channel is in stop mode.



XCM519 Series

查询XCM519供应商

ELECTRICAL CHARACTERISTICS (Continued)

●XCM519xD 1ch (DC/DC BLOCK) DCOUT=1.8V, f_{OSC}=3.0MHz, Ta=25°C

| PARAMETER | SYMBOL | CONDITIONS | MIN. | TYP. | MAX. | UNITS | CIRCUIT | |
|--|------------------------|---|-----------------|-------|-------|--------|---------|---|
| Output Voltage | V _{DCOUT} | When connected to external components, V _{IN1} =V _{EN1} =5.0V, I _{OUT1} =30mA | 1.764 | 1.800 | 1.836 | V | ① | |
| Operating Voltage Range | V _{IN1} | | 2.7 | - | 6.0 | V | ① | |
| Maximum Output Current | I _{OUT1MAX} | When connected to external components, V _{IN1} =DCOUT(E)V+2.0V, V _{EN1} =1.0V ^{(*)8} | 600 | - | - | mA | ① | |
| UVLO Voltage | V _{UVLO} | V _{EN1} =V _{IN1} , DCOUT=0V, Voltage which Lx pin holding "L" level ^{(*)1, (*)10} | 1.00 | 1.40 | 1.78 | V | ② | |
| Supply Current | I _{DD} | V _{IN1} =V _{EN1} =5.0V, DCOUT=DCOUT(E)×1.1V | (XCM519AD) | - | 46 | 65 | μA | ③ |
| | | | (XCM519BD) | - | 21 | 35 | | |
| Stand-by Current | I _{STB} | V _{IN1} =5.0V, V _{EN1} =0V, DCOUT=DCOUT(E)×1.1V | - | 0 | 1.0 | μA | ③ | |
| Oscillation Frequency | f _{OSC} | When connected to external components, V _{IN1} =DCOUT(E)V+2.0V, V _{EN1} =1.0V, I _{OUT1} =100mA | 2550 | 3000 | 3450 | kHz | ① | |
| PFM Switching Current | I _{PFM} | When connected to external components, V _{IN1} =DCOUT(E)V+2.0V, V _{EN1} =V _{IN1} , I _{OUT1} =1mA ^{(*)11} | 170 | 220 | 270 | mA | ① | |
| PFM Duty Limit | D _{LIMIT_PFM} | V _{EN1} =V _{IN1} =(C-1)I _{OUT1} =1mA ^{(*)11} | - | 200 | 300 | % | ② | |
| Maximum Duty Ratio | D _{MAX} | V _{IN1} =V _{EN1} =5.0V, DCOUT=DCOUT(E)×0.9V | 100 | - | - | % | ② | |
| Minimum Duty Ratio | D _{MIN} | V _{IN1} =V _{EN1} =5.0V, DCOUT=DCOUT(E)×1.1V | - | - | 0 | % | ② | |
| Efficiency | EFFI | When connected to external components, V _{EN1} =V _{IN1} =DCOUT(E)+1.2V ^{(*)7} , I _{OUT1} =100mA | - | 86 | - | % | ① | |
| Lx SW "H" ON Resistance 1 | RL _{XH} | V _{IN1} =V _{EN1} =5.0V, DCOUT=0V, I _{LX} =100mA ^{(*)3} | - | 0.35 | 0.55 | Ω | ④ | |
| Lx SW "H" ON Resistance 2 | RL _{XH} | V _{IN1} =V _{EN1} =3.6V, DCOUT=0V, I _{LX} =100mA ^{(*)3} | - | 0.42 | 0.67 | Ω | ④ | |
| Lx SW "L" ON Resistance 1 | RL _{XL} | V _{IN1} =V _{EN1} =5.0V ^{(*)4} | - | 0.45 | 0.66 | Ω | - | |
| Lx SW "L" ON Resistance 2 | RL _{XL} | V _{IN1} =V _{EN1} =3.6V ^{(*)4} | - | 0.52 | 0.77 | Ω | - | |
| Lx SW "H" Leak Current ^{(*)5} | I _{LEAKH} | V _{IN1} =DCOUT=5.0V, V _{EN1} =0V, L _X =0V | - | 0.01 | 1.0 | μA | ⑨ | |
| Current Limit ^{(*)9} | I _{LIM} | V _{IN1} =V _{EN1} =5.0V, DCOUT=DCOUT(E)×0.9V | 900 | 1050 | 1350 | mA | ⑥ | |
| Output Voltage Temperature Characteristics | ΔDCOUT / (DCOUT·Δtopr) | I _{OUT1} =30mA -40°C ≤ Topr ≤ 85°C | - | ±100 | - | ppm/°C | ① | |
| EN1 "H" Level Voltage | V _{EN1H} | DCOUT=0V, Applied voltage to V _{EN1} , Voltage changes Lx to "H" level ^{(*)10} | 0.65 | - | 6.0 | V | ③ | |
| EN1 "L" Level Voltage | V _{EN1L} | DCOUT=0V, Applied voltage to V _{EN1} , Voltage changes Lx to "L" level ^{(*)10} | V _{SS} | - | 0.25 | V | ③ | |
| EN1 "H" Current | I _{EN1H} | V _{IN1} =V _{EN1} =5.0V, DCOUT=0V | - 0.1 | - | 0.1 | μA | ⑤ | |
| EN1 "L" Current | I _{EN1L} | V _{IN1} =5.0V, V _{EN1} =0V, DCOUT=0V | - 0.1 | - | 0.1 | μA | ⑤ | |
| Soft Start Time | t _{SS} | When connected to external components, V _{EN1} =0V→V _{IN1} , I _{OUT1} =1mA | - | 0.32 | 0.50 | ms | ① | |
| Latch Time | t _{LAT} | V _{IN1} =V _{EN1} =5.0V, DCOUT=0.8×DCOUT(E) Short Lx at 1Ω resistance ^{(*)6} | 1.0 | - | 20 | ms | ⑦ | |
| Short Protection Threshold Voltage | V _{SHORT} | Sweeping DCOUT, V _{IN1} =V _{EN1} =5.0V, Short Lx at 1Ω resistance, DCOUT voltage which Lx becomes "L" level within 1ms | 0.675 | 0.900 | 1.150 | V | ⑦ | |
| C _L Discharge | R _{DCHG} | V _{IN1} =5.0V, L _X =5.0V, V _{EN1} =0V, DCOUT=Open | 200 | 300 | 450 | Ω | ⑧ | |

Test conditions: Unless otherwise stated, V_{IN1}=5.0V, V_{DCOUT(E)}= Nominal voltage

NOTE:

*1: Including hysteresis width of operating voltage.

*2: EFFI = { (output voltage × output current) / (input voltage × input current) } × 100

*3: ON resistance (Ω) = (V_{IN} - Lx pin measurement voltage) / 100mA

*4: Design value

*5: When temperature is high, a current of approximately 10 μA (maximum) may leak.

*6: Time until it short-circuits DCOUT with GND via 1Ω of resistor from an operational state and is set to Lx=0V from current limit pulse generating.

*7: V_{DCOUT(E)}+1.2V<2.7V, V_{IN}=2.7V.

*8: When the difference between the input and the output is small, some cycles may be skipped completely before current maximizes.

If current is further pulled from this state, output voltage will decrease because of P-ch driver ON resistance.

*9: Current limit denotes the level of detection at peak of coil current.

*10: "H"=V_{IN}~V_{IN}-1.2V, "L"=+0.1V ~ -0.1V

*11: XCM519A series exclude I_{PFM} and D_{LIMIT_PFM} because those are only for the PFM control's functions.

* The electrical characteristics above are when the other channel is in stop mode.



[查询XCM519供应商](#)

■ ELECTRICAL CHARACTERISTICS (Continued)

● PFM Switching Current (I_{PFM}) by Oscillation Frequency and Output Voltage

1.2MHz (mA)

| SETTING VOLTAGE | MIN. | TYP. | MAX. |
|----------------------------------|------|------|------|
| $V_{DCOUT(E)} \leq 1.2V$ | 140 | 180 | 240 |
| $1.2V < V_{DCOUT(E)} \leq 1.75V$ | 130 | 170 | 220 |
| $1.8V \leq V_{DCOUT(E)}$ | 120 | 160 | 200 |

3.0MHz (mA)

| SETTING VOLTAGE | MIN. | TYP. | MAX. |
|----------------------------------|------|------|------|
| $V_{DCOUT(E)} \leq 1.2V$ | 190 | 260 | 350 |
| $1.2V < V_{DCOUT(E)} \leq 1.75V$ | 180 | 240 | 300 |
| $1.8V \leq V_{DCOUT(E)}$ | 170 | 220 | 270 |

● Measuring Maximum I_{PFM} Limit, V_{IN} Voltage

| f_{OSC} | 1.2MHz | 3.0MHz |
|-----------|-----------------------|-----------------------|
| (C-1) | $V_{DCOUT(E)} + 0.5V$ | $V_{DCOUT(E)} + 1.0V$ |

Minimum operating voltage is 2.7V

ex.) Although when $V_{DCOUT(E)} = 1.2V$, $f_{OSC} = 1.2MHz$, (C-1) = 1.7V the (C-1) becomes 2.7V because of the minimum operating voltage 2.7V.

● Soft-Start Time Chart (XCM519xC/ XCM519xD Series Only)

| PRODUCT SERIES | f_{OSC} | OUTPUT VOLTAGE | MIN. | TYP. | MAX. |
|----------------|-----------|-------------------------------|------|------|-------------|
| XCM519AC | 1200kHz | $0.8 \leq V_{DCOUT(E)} < 1.5$ | - | 250 | 400 μs |
| | 1200kHz | $1.5 \leq V_{DCOUT(E)} < 1.8$ | - | 320 | 500 μs |
| | 1200kHz | $1.8 \leq V_{DCOUT(E)} < 2.5$ | - | 250 | 400 μs |
| | 1200kHz | $2.5 \leq V_{DCOUT(E)} < 4.0$ | - | 320 | 500 μs |
| XCM519BC | 1200kHz | $0.8 \leq V_{DCOUT(E)} < 2.5$ | - | 250 | 400 μs |
| | 1200kHz | $2.5 \leq V_{DCOUT(E)} < 4.0$ | - | 320 | 500 μs |
| XCM519xD | 3000kHz | $0.8 \leq V_{DCOUT(E)} < 1.8$ | - | 250 | 400 μs |
| | 3000kHz | $1.8 \leq V_{DCOUT(E)} < 4.0$ | - | 320 | 500 μs |

XCM519 Series

查询XCM519供应商

ELECTRICAL CHARACTERISTICS (Continued)

●XCM519xx 2ch (REGULATOR BLOCK)

| PARAMETER | SYMBOL | CONDITIONS | MIN. | TYP. | MAX. | UNITS | CIRCUIT |
|------------------------------------|---|---|--------------------|--|-------|-------|---------|
| Bias Voltage ⁽¹⁾ | V _{BIAS} | V _{EN2} = V _{BIAS} , V _{IN2} = V _{ROUT(T)} + 0.3V | 2.5 | - | 6.0 | V | - |
| Input Voltage ⁽²⁾ | V _{IN2} | V _{BIAS} = V _{EN2} = 3.6V | 1.0 | - | 3.0 | V | - |
| Output Voltage | V _{ROUT(E)} ⁽³⁾ | V _{BIAS} = V _{EN2} = 3.6V, V _{IN2} = V _{ROUT(T)} + 0.3V, I _{ROUT} = 1mA | -0.02 | V _{OUT(T)} ⁽⁴⁾ E-0 ⁽⁵⁾ | +0.02 | V | - |
| Maximum Output Current1 | I _{OUTMAX1} | V _{EN2} = V _{BIAS} , V _{BIAS} - V _{ROUT(T)} ≥ 1.2V V _{IN2} = V _{ROUT(T)} + 0.5V | 200 | - | - | mA | ⑩ |
| Maximum Output Current2 | I _{OUTMAX2} | V _{EN2} = V _{BIAS} , V _{BIAS} - V _{ROUT(T)} ≥ 1.3V V _{IN2} = V _{ROUT(T)} + 0.5V | 300 | - | - | mA | ⑩ |
| Maximum Output Current3 | I _{OUTMAX3} | V _{EN2} = V _{BIAS} , V _{BIAS} - V _{ROUT(T)} ≥ 1.5V V _{IN2} = V _{ROUT(T)} + 0.5V | 400 | - | - | mA | ⑩ |
| Load Regulation | ΔV _{ROUT} | V _{BIAS} = V _{EN2} = 3.6V, V _{IN2} = V _{ROUT(T)} + 0.3V, 1mA ≤ I _{ROUT} ≤ 100mA | - | 8 | 17 | mV | - |
| Dropout Voltage1 | V _{dif1} ⁽⁷⁾ | V _{EN2} = V _{BIAS} , I _{OUT} = 100mA | E-1 ⁽⁶⁾ | | | mV | ⑩ |
| Dropout Voltage2 | V _{dif2} ⁽⁷⁾ | V _{EN2} = V _{BIAS} , I _{OUT} = 200mA | E-2 ⁽⁶⁾ | | | mV | ⑩ |
| Dropout Voltage3 | V _{dif3} ⁽⁷⁾ | V _{EN2} = V _{BIAS} , I _{OUT} = 300mA | E-3 ⁽⁶⁾ | | | mV | ⑩ |
| Dropout Voltage4 | V _{dif4} ⁽⁷⁾ | V _{EN2} = V _{BIAS} , I _{OUT} = 400mA | E-4 ⁽⁶⁾ | | | mV | ⑩ |
| Supply Current 1 | I _{BIAS} | V _{BIAS} = V _{EN2} = 3.6V, V _{IN2} = V _{ROUT(T)} + 0.3V V _{ROUT(T)} = OPEN | 8 | 25 | 45 | μA | ⑩ |
| Supply Current 2 | I _{IN2} | V _{BIAS} = V _{EN2} = 3.6V, V _{IN2} = V _{ROUT(T)} + 0.3V V _{ROUT(T)} = OPEN | - | 1.0 | 2.5 | μA | ⑩ |
| Bias Current ⁽¹⁰⁾ | I _{BIASMAX} | V _{ROUT(T)} ≥ 0.95V, V _{BIAS} = V _{EN2} = 3.6V, V _{IN2} = V _{ROUT(T)} + 0.05V, V _{ROUT} = V _{ROUT(T)} - 0.05V | - | 1.0 | 2.5 | mA | ⑩ |
| | | V _{ROUT(T)} < 0.95V, V _{BIAS} = V _{EN2} = 3.6V, V _{IN2} = 1.0V, V _{ROUT} = V _{ROUT(T)} - 0.05V | | | | | |
| Stand-by Current 1 | I _{BIAS_STB} | V _{BIAS} = 6.0V, V _{IN2} = 3.0V, V _{EN2} = V _{SS2} | - | 0.01 | 0.10 | μA | ⑩ |
| Stand-by Current 2 | I _{IN_STB} | V _{BIAS} = 6.0V, V _{IN2} = 3.0V, V _{EN2} = V _{SS2} | - | 0.01 | 0.35 | μA | ⑩ |
| Bias Regulation | ΔV _{ROUT} / (ΔV _{BIAS} · V _{ROUT}) | V _{ROUT(T)} ≥ 1.3V V _{ROUT(T)} + 1.2V ≤ V _{BIAS} ≤ 6.0V, V _{IN2} = V _{ROUT(T)} + 0.3V, V _{EN2} = V _{BIAS} , I _{OUT} = 1mA | - | 0.01 | 0.3 | %/V | ⑩ |
| | | V _{ROUT(T)} < 1.3V 2.5V ≤ V _{BIAS} ≤ 6.0V, V _{IN2} = V _{ROUT(T)} + 0.3V, V _{EN2} = V _{BIAS} , I _{OUT} = 1mA | | | | | |
| Input Regulation | ΔV _{ROUT} / (ΔV _{IN2} · V _{ROUT}) | V _{ROUT(T)} ≥ 0.90V, V _{ROUT(T)} + 0.1V ≤ V _{IN2} ≤ 3.0V, V _{BIAS} = V _{EN2} = 3.6V, I _{OUT} = 1mA | - | 0.01 | 0.1 | %/V | ⑩ |
| | | V _{ROUT(T)} < 0.90V, 1.0V ≤ V _{IN2} ≤ 3.0V V _{BIAS} = V _{EN2} = 3.6V, I _{OUT} = 1mA | | | | | |
| Bias Voltage UVLO | V _{BIAS_UVLO} | V _{EN2} = V _{BIAS} , V _{IN2} = V _{ROUT(T)} + 0.3V, I _{OUT} = 1mA | 1.37 | 2.0 | 2.5 | V | ⑩ |
| Input Voltage UVLO | V _{IN_UVLO} | V _{BIAS} = V _{EN2} = 3.6V, I _{ROUT} = 1mA | 0.07 | 0.4 | 0.6 | V | ⑩ |
| V _{BIAS} Ripple Rejection | V _{BIAS_PSR} | V _{BIAS} = 3.6V _{DC} + 0.2V _{p-pAC} , V _{IN2} = V _{ROUT(T)} + 0.3V, I _{OUT} = 30mA, f = 1kHz | - | 40 | - | dB | ⑪ |
| V _{IN2} Ripple Rejection | V _{IN_PSR} | V _{IN2} = V _{OUT(T)} + 0.3V _{DC} + 0.2V _{p-pAC} , V _{BIAS} = 3.6V, I _{OUT} = 30mA, f = 1kHz | - | 60 | - | dB | ⑪ |

查询XCM519供应商

ELECTRICAL CHARACTERISTICS (Continued)

●XCM519xx 2ch (REGULATOR BLOCK) (Continued)

| PARAMETER | SYMBOL | CONDITIONS | MIN. | TYP. | MAX. | UNITS | CIRCUIT |
|--|---|---|------|-----------|------|------------------|---------|
| Output Voltage Temperature Characteristics | $\Delta V_{ROUT}/(\Delta T_{opr} \cdot V_{ROUT})$ | $V_{BIAS}=V_{EN2}=3.6V, V_{IN2}=V_{ROUT(T)}+0.3V, I_{OUT}=30mA, -40^{\circ}C \leq T_{opr} \leq 85^{\circ}C$ | - | ± 100 | - | ppm/ $^{\circ}C$ | ⑩ |
| Limit Current | I_{LIM} | $V_{ROUT}=V_{ROUT(T)} \times 0.95, V_{BIAS}=V_{EN2}=3.6V, V_{IN2}=V_{ROUT(T)}+0.3V$ | 400 | - | - | mA | ⑩ |
| Short Current | I_{SHORT} | $V_{BIAS}=V_{EN2}=3.6V, V_{IN2}=V_{ROUT(T)}+0.3V, V_{ROUT}=0V$ | - | 80 | - | mA | ⑩ |
| Thermal Shutdown Detect Temperature | T_{TSD} | Junction Temperature | - | 150 | - | $^{\circ}C$ | ⑩ |
| Thermal Shutdown Release Temperature | T_{TSR} | Junction Temperature | - | 125 | - | $^{\circ}C$ | ⑩ |
| TSD Hysteresis Width | $T_{TSD} - T_{TSR}$ | | - | 25 | - | $^{\circ}C$ | ⑩ |
| CL Auto-Discharge Resistance | R_{DCHG} | $V_{BIAS}=3.6V, V_{IN2}=V_{ROUT(T)}+0.3V, V_{EN2}=V_{SS}, V_{ROUT}=V_{ROUT(T)}$ | 290 | 430 | 610 | Ω | ⑩ |
| EN2 "H" Level Voltage | V_{EN2H} | $V_{BIAS}=3.6V, V_{IN2}=V_{ROUT(T)}+0.3V$ | 0.75 | - | 6.0 | V | ⑩ |
| EN2 "L" Level Voltage | V_{EN2L} | $V_{BIAS}=3.6V, V_{IN2}=V_{ROUT(T)}+0.3V$ | - | - | 0.16 | V | ⑩ |
| EN2 "H" Level Current | I_{EN2H} | $V_{BIAS}=V_{EN2}=6.0V, V_{IN2}=V_{ROUT(T)}+0.3V$ | -0.1 | - | 0.1 | μA | ⑩ |
| EN2 "L" Level Current | I_{EN2L} | $V_{BIAS}=6.0V, V_{EN2}=V_{SS}, V_{IN2}=V_{ROUT(T)}+0.3V$ | -0.1 | - | 0.1 | μA | ⑩ |
| Soft Start Time ⁽¹¹⁾ | t_{SS} | $V_{BIAS}=3.6V, V_{IN2}=V_{ROUT(T)}+0.3V, I_{OUT}=1mA, V_{EN2}=0V \rightarrow 3.6V$ | 100 | - | 410 | μs | ⑫ |

NOTE:

- * 1: Please use Bias voltage V_{BIAS} within the range $V_{BIAS} - V_{ROUT(T)} \geq 0.9V$
- * 2: Please use Input voltage V_{IN} within the range $V_{IN} \leq V_{BIAS}$
- * 3: $V_{ROUT(E)}$: Effective output voltage
- * 4: $V_{ROUT(T)}$: Specified output voltage
- * 5: E-0 = Please refer to the table named OUTPUT VOLTAGE CHART
- * 6: E-1 = Please refer to the table named DROPOUT VOLTAGE CHART
- * 7: $V_{dif} = \{V_{IN21}^{(8)} - V_{ROUT1}^{(9)}\}$
- * 8: V_{IN21} : The input voltage when V_{OUT1} appears as input voltage is gradually decreased.
- * 9: V_{ROUT1} : A voltage equal to 98% of the output voltage while maintaining an amply stabilized output voltage when $V_{BIAS} < 3.0V$ at $V_{IN2} = V_{BIAS}, V_{BIAS} \geq 3.0V$ at $V_{IN2} = V_{BIAS}$ input to the V_{BIAS} pin.
- * 10: $I_{BIASMAX}$: A supply current at the V_{BIAS} pin providing for the output current (I_{VROUT}).
- * 11: t_{SS} : Time that V_{ROUT} becomes more than $V_{ROUT(E)} \times 0.9V$ after the EN2 pin is input 0.75V as EN2 "H" level voltage.
- * The electrical characteristics above are when the other channel is in stop mode.

OUTPUT VOLTAGE CHART

| NOMINAL OUTPUT VOLTAGE (V) | E-0 | |
|----------------------------|--------------------|-------|
| | OUTPUT VOLTAGE (V) | |
| | V_{ROUT} | |
| $V_{ROUT(T)}$ | MIN. | MAX. |
| 0.70 | 0.680 | 0.720 |
| 0.75 | 0.730 | 0.770 |
| 0.80 | 0.780 | 0.820 |
| 0.85 | 0.830 | 0.870 |
| 0.90 | 0.880 | 0.920 |
| 0.95 | 0.930 | 0.970 |
| 1.00 | 0.980 | 1.020 |
| 1.05 | 1.030 | 1.070 |
| 1.10 | 1.080 | 1.120 |
| 1.15 | 1.130 | 1.170 |
| 1.20 | 1.180 | 1.220 |
| 1.25 | 1.230 | 1.270 |

| NOMINAL OUTPUT VOLTAGE (V) | E-0 | |
|----------------------------|--------------------|-------|
| | OUTPUT VOLTAGE (V) | |
| | V_{ROUT} | |
| $V_{ROUT(T)}$ | MIN. | MAX. |
| 1.30 | 1.280 | 1.320 |
| 1.35 | 1.330 | 1.370 |
| 1.40 | 1.380 | 1.420 |
| 1.45 | 1.430 | 1.470 |
| 1.50 | 1.480 | 1.520 |
| 1.55 | 1.530 | 1.570 |
| 1.60 | 1.580 | 1.620 |
| 1.65 | 1.630 | 1.670 |
| 1.70 | 1.680 | 1.720 |
| 1.75 | 1.730 | 1.770 |
| 1.80 | 1.780 | 1.820 |

XCM519 Series

[查询XCM519供应商](#)

■ DROPOUT VOLTAGE CHART

| NOMINAL OUTPUT VOLTAGE (V) | E-1 | | | | | | | | | | | | | | |
|----------------------------|---------------------------|------------------------------------|-----------|---------------------------|---------------------|-----------|---------------------------|---------------------|-----------|---------------------------|---------------------|-----------|---------------------------|---------------------|-----------|
| | DROPOUT VOLTAGE1 (mV) | | | | | | | | | | | | | | |
| | Vdif1 | | | | | | | | | | | | | | |
| | V _{BIAS} =3.0(V) | | | V _{BIAS} =3.3(V) | | | V _{BIAS} =3.6(V) | | | V _{BIAS} =4.2(V) | | | V _{BIAS} =5.0(V) | | |
| | V _{ROUT(T)} | V _{gs} ^(*) (V) | Vdif (mV) | | V _{gs} (V) | Vdif (mV) | | V _{gs} (V) | Vdif (mV) | | V _{gs} (V) | Vdif (mV) | | V _{gs} (V) | Vdif (mV) |
| TYP. | | MAX. | TYP. | MAX. | TYP. | MAX. | TYP. | MAX. | TYP. | MAX. | TYP. | MAX. | TYP. | MAX. | |
| 0.70 | 2.30 | 40 | 300 | 2.60 | 35 | 300 | 2.90 | 33 | 300 | 3.50 | 30 | 300 | 4.30 | 27 | 300 |
| 0.75 | 2.25 | 41 | 250 | 2.55 | 36 | 250 | 2.85 | 34 | 250 | 3.45 | 31 | 250 | 4.25 | 28 | 250 |
| 0.80 | 2.20 | | 200 | 2.50 | | 200 | 2.80 | | 200 | 3.40 | | 200 | 4.20 | | 200 |
| 0.85 | 2.15 | 42 | 150 | 2.45 | 38 | 150 | 2.75 | 34 | 150 | 3.35 | 31 | 150 | 4.15 | 28 | 150 |
| 0.90 | 2.10 | | 100 | 2.40 | | 100 | 2.70 | | 100 | 3.30 | | 100 | 4.10 | | 100 |
| 0.95 | 2.05 | 43 | 68 | 2.35 | 40 | 61 | 2.65 | 35 | 56 | 3.25 | 32 | 50 | 4.05 | 28 | 50 |
| 1.00 | 2.00 | | 2.30 | 2.60 | | 3.20 | 49 | | 4.00 | 44 | | | | | |
| 1.05 | 1.95 | 46 | 72 | 2.25 | 41 | 63 | 2.55 | 36 | 58 | 3.15 | 32 | 50 | 3.95 | 29 | 45 |
| 1.10 | 1.90 | | 2.20 | 2.50 | | 3.10 | 3.90 | | | | | | | | |
| 1.15 | 1.85 | 48 | 75 | 2.15 | 42 | 65 | 2.45 | 38 | 59 | 3.05 | 32 | 51 | 3.85 | 29 | 46 |
| 1.20 | 1.80 | | 2.10 | 2.40 | | 3.00 | 3.80 | | | | | | | | |
| 1.25 | 1.75 | 51 | 81 | 2.05 | 43 | 68 | 2.35 | 40 | 61 | 2.95 | 33 | 52 | 3.75 | 29 | 47 |
| 1.30 | 1.70 | | 2.00 | 2.30 | | 2.90 | 3.70 | | | | | | | | |
| 1.35 | 1.65 | 54 | 87 | 1.95 | 46 | 72 | 2.25 | 41 | 63 | 2.85 | 34 | 53 | 3.65 | 30 | 47 |
| 1.40 | 1.60 | | 1.90 | 2.20 | | 2.80 | 3.60 | | | | | | | | |
| 1.45 | 1.55 | 57 | 92 | 1.85 | 48 | 75 | 2.15 | 42 | 65 | 2.75 | 34 | 54 | 3.55 | 30 | 48 |
| 1.50 | 1.50 | | 1.80 | 2.10 | | 2.70 | 3.50 | | | | | | | | |
| 1.55 | 1.45 | 61 | 94 | 1.75 | 51 | 81 | 2.05 | 43 | 68 | 2.65 | 35 | 56 | 3.45 | 31 | 48 |
| 1.60 | 1.40 | 63 | 97 | 1.70 | | 2.00 | 2.60 | | 3.40 | | | | | | |
| 1.65 | 1.35 | 67 | 104 | 1.65 | 54 | 87 | 1.95 | 46 | 72 | 2.55 | 36 | 58 | 3.35 | 31 | 49 |
| 1.70 | 1.30 | 70 | 113 | 1.60 | | 1.90 | 2.50 | | 3.30 | | | | | | |
| 1.75 | 1.25 | 74 | 131 | 1.55 | 57 | 92 | 1.85 | 48 | 75 | 2.45 | 38 | 59 | 3.25 | 32 | 49 |
| 1.80 | 1.20 | 79 | 154 | 1.50 | | 1.80 | 2.40 | | 3.20 | | | | | | |

*1): V_{gs} is a Gate –Source voltage of the driver transistor that is defined as the value of V_{BIAS} - V_{ROUT(T)}.

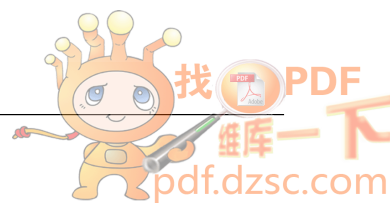

[查询XCM519供应商](#)

■ DROPOUT VOLTAGE CHART (Continued)

| NOMINAL OUTPUT VOLTAGE (V) | E-2 | | | | | | | | | | | | | | |
|----------------------------|---------------------------|------------------------------------|-----------|---------------------------|---------------------|-----------|---------------------------|---------------------|-----------|---------------------------|---------------------|-----------|---------------------------|---------------------|-----------|
| | DROPOUT VOLTAGE 2 (mV) | | | | | | | | | | | | | | |
| | Vdif2 | | | | | | | | | | | | | | |
| | V _{BIAS} =3.0(V) | | | V _{BIAS} =3.3(V) | | | V _{BIAS} =3.6(V) | | | V _{BIAS} =4.2(V) | | | V _{BIAS} =5.0(V) | | |
| | V _{ROUT(T)} | V _{gs} ^(*) (V) | Vdif (mV) | | V _{gs} (V) | Vdif (mV) | | V _{gs} (V) | Vdif (mV) | | V _{gs} (V) | Vdif (mV) | | V _{gs} (V) | Vdif (mV) |
| | | TYP | MAX | | TYP | MAX | | TYP | MAX | | TYP | MAX | | TYP | MAX |
| 0.70 | 2.30 | 81 | 300 | 2.60 | 74 | 300 | 2.90 | 68 | 300 | 3.50 | 62 | 300 | 4.30 | 57 | 300 |
| 0.75 | 2.25 | 85 | 250 | 2.55 | 76 | 250 | 2.85 | 70 | 250 | 3.45 | 63 | 250 | 4.25 | 58 | 250 |
| 0.80 | 2.20 | | 200 | 2.50 | | 200 | 2.80 | | 200 | 3.40 | | 200 | 4.20 | | 200 |
| 0.85 | 2.15 | 88 | 150 | 2.45 | 78 | 150 | 2.75 | 72 | 150 | 3.35 | 63 | 150 | 4.15 | 58 | 150 |
| 0.90 | 2.10 | | 131 | 2.40 | | 117 | 2.70 | | 110 | 3.30 | | 100 | 4.10 | | 100 |
| 0.95 | 2.05 | 90 | 139 | 2.35 | 81 | 123 | 2.65 | 74 | 111 | 3.25 | 64 | 98 | 4.05 | 58 | 88 |
| 1.00 | 2.00 | | 2.30 | 2.60 | | 3.20 | 4.00 | | | | | | | | |
| 1.05 | 1.95 | 96 | 146 | 2.25 | 85 | 127 | 2.55 | 76 | 114 | 3.15 | 65 | 101 | 3.95 | 59 | 90 |
| 1.10 | 1.90 | | 2.20 | 2.50 | | 3.10 | 3.90 | | | | | | | | |
| 1.15 | 1.85 | 101 | 154 | 2.15 | 88 | 131 | 2.45 | 78 | 117 | 3.05 | 67 | 103 | 3.85 | 59 | 91 |
| 1.20 | 1.80 | | 2.10 | 2.40 | | 3.00 | 3.80 | | | | | | | | |
| 1.25 | 1.75 | 108 | 170 | 2.05 | 90 | 139 | 2.35 | 81 | 123 | 2.95 | 68 | 106 | 3.75 | 60 | 92 |
| 1.30 | 1.70 | | 2.00 | 2.30 | | 2.90 | 3.70 | | | | | | | | |
| 1.35 | 1.65 | 115 | 179 | 1.95 | 96 | 146 | 2.25 | 85 | 127 | 2.85 | 70 | 108 | 3.65 | 61 | 93 |
| 1.40 | 1.60 | | 1.90 | 2.20 | | 2.80 | 3.60 | | | | | | | | |
| 1.45 | 1.55 | 122 | 192 | 1.85 | 101 | 154 | 2.15 | 88 | 131 | 2.75 | 72 | 110 | 3.55 | 62 | 94 |
| 1.50 | 1.50 | | 1.80 | 2.10 | | 2.70 | 3.50 | | | | | | | | |
| 1.55 | 1.45 | 129 | 197 | 1.75 | 108 | 170 | 2.05 | 90 | 139 | 2.65 | 74 | 111 | 3.45 | 63 | 95 |
| 1.60 | 1.40 | 135 | 206 | 1.70 | | 2.00 | 2.60 | | 3.40 | | | | | | |
| 1.65 | 1.35 | 145 | 223 | 1.65 | 115 | 179 | 1.95 | 96 | 146 | 2.55 | 76 | 114 | 3.35 | 63 | 97 |
| 1.70 | 1.30 | 154 | 248 | 1.60 | | 1.90 | 2.50 | | 3.30 | | | | | | |
| 1.75 | 1.25 | 165 | 293 | 1.55 | 122 | 192 | 1.85 | 101 | 154 | 2.45 | 78 | 117 | 3.25 | 64 | 98 |
| 1.80 | 1.20 | 175 | 353 | 1.50 | | 1.80 | 2.40 | | 3.20 | | | | | | |

*1): V_{gs} is a Gate –Source voltage of the driver transistor that is defined as the value of V_{BIAS} - V_{ROUT(T)}.

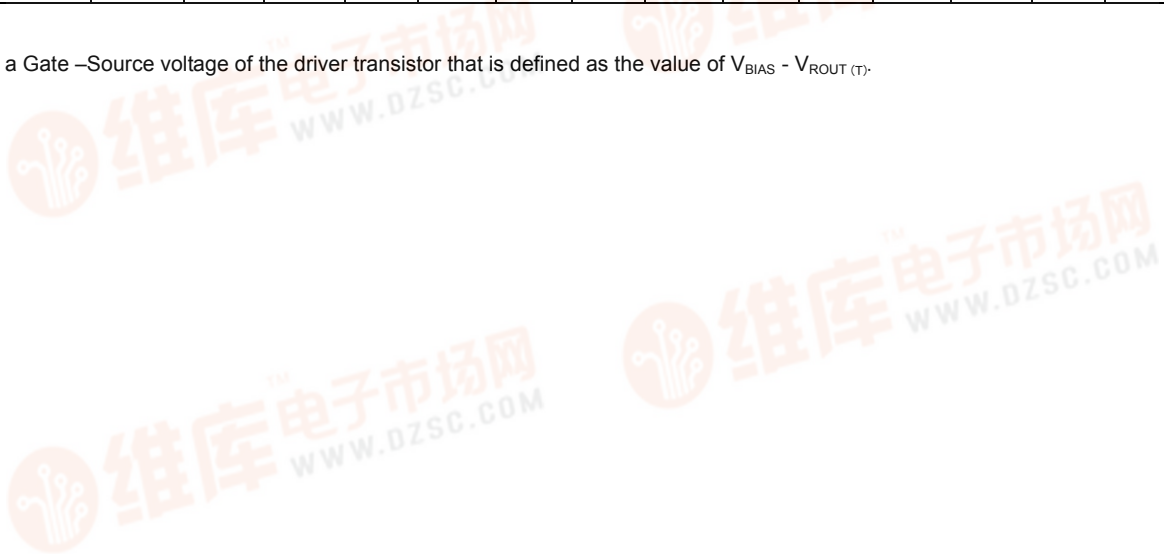

XCM519 Series

[查询XCM519供应商](#)

■ DROPOUT VOLTAGE CHART (Continued)

| NOMINAL OUTPUT VOLTAGE (V) | E-3 | | | | | | | | | | | | | | |
|----------------------------|---------------------------|------------------------------------|----------|---------------------------|---------------------|----------|---------------------------|---------------------|----------|---------------------------|---------------------|----------|---------------------------|---------------------|----------|
| | DROPOUT VOLTAGE 3 (mV) | | | | | | | | | | | | | | |
| | Vdif3 | | | | | | | | | | | | | | |
| | V _{BIAS} =3.0(V) | | | V _{BIAS} =3.3(V) | | | V _{BIAS} =3.6(V) | | | V _{BIAS} =4.2(V) | | | V _{BIAS} =5.0(V) | | |
| | V _{VROUT(T)} | V _{gs} ^(*) (V) | Vdif(mV) | | V _{gs} (V) | Vdif(mV) | | V _{gs} (V) | Vdif(mV) | | V _{gs} (V) | Vdif(mV) | | V _{gs} (V) | Vdif(mV) |
| TYP | | | MAX | TYP | | MAX | TYP | | MAX | TYP | | MAX | TYP | | MAX |
| 0.70 | 2.30 | 130 | 300 | 2.60 | 115 | 300 | 2.90 | 107 | 300 | 3.50 | 95 | 300 | 4.30 | 89 | 300 |
| 0.75 | 2.25 | 134 | 250 | 2.55 | 117 | 250 | 2.85 | 109 | 250 | 3.45 | 96 | 250 | 4.25 | 90 | 250 |
| 0.80 | 2.20 | | 200 | 2.50 | | 200 | 2.80 | | 200 | 3.40 | | 200 | 4.20 | | 200 |
| 0.85 | 2.15 | 138 | 204 | 2.45 | 119 | 181 | 2.75 | 111 | 167 | 3.35 | 97 | 150 | 4.15 | 90 | 150 |
| 0.90 | 2.10 | | | 2.40 | | | 2.70 | | | 3.30 | | 148 | 4.10 | | 132 |
| 0.95 | 2.05 | 145 | 216 | 2.35 | 130 | 190 | 2.65 | 115 | 170 | 3.25 | 98 | 151 | 4.05 | 91 | 134 |
| 1.00 | 2.00 | | | 2.30 | | | 2.60 | | | 3.20 | | 4.00 | | | |
| 1.05 | 1.95 | 153 | 227 | 2.25 | 134 | 197 | 2.55 | 117 | 176 | 3.15 | 101 | 153 | 3.95 | 92 | 137 |
| 1.10 | 1.90 | | | 2.20 | | | 2.50 | | | 3.10 | | 3.90 | | | |
| 1.15 | 1.85 | 161 | 239 | 2.15 | 138 | 204 | 2.45 | 119 | 181 | 3.05 | 105 | 155 | 3.85 | 93 | 139 |
| 1.20 | 1.80 | | | 2.10 | | | 2.40 | | | 3.00 | | 3.80 | | | |
| 1.25 | 1.75 | 173 | 264 | 2.05 | 145 | 216 | 2.35 | 130 | 190 | 2.95 | 107 | 159 | 3.75 | 93 | 140 |
| 1.30 | 1.70 | | | 2.00 | | | 2.30 | | | 2.90 | | 3.70 | | | |
| 1.35 | 1.65 | 184 | 289 | 1.95 | 153 | 227 | 2.25 | 134 | 197 | 2.85 | 109 | 163 | 3.65 | 94 | 141 |
| 1.40 | 1.60 | | | 1.90 | | | 2.20 | | | 2.80 | | 3.60 | | | |
| 1.45 | 1.55 | 196 | 313 | 1.85 | 161 | 239 | 2.15 | 138 | 204 | 2.75 | 111 | 167 | 3.55 | 95 | 142 |
| 1.50 | 1.50 | | | 1.80 | | | 2.10 | | | 2.70 | | 3.50 | | | |
| 1.55 | 1.45 | 209 | 323 | 1.75 | 173 | 264 | 2.05 | 145 | 216 | 2.65 | 115 | 170 | 3.45 | 96 | 145 |
| 1.60 | 1.40 | | | 222 | | | 344 | | | 1.70 | | 2.00 | 2.60 | | |
| 1.65 | 1.35 | 239 | 388 | 1.65 | 184 | 289 | 1.95 | 153 | 227 | 2.55 | 117 | 176 | 3.35 | 97 | 148 |
| 1.70 | 1.30 | | | 256 | | | 442 | | | 1.60 | | 1.90 | 2.50 | | |
| 1.75 | 1.25 | - | - | 1.55 | 196 | 313 | 1.85 | 161 | 239 | 2.45 | 119 | 181 | 3.25 | 98 | 151 |
| 1.80 | 1.20 | | | 1.50 | | | 1.80 | | | 2.40 | | 3.20 | | | |

*1): V_{gs} is a Gate –Source voltage of the driver transistor that is defined as the value of V_{BIAS} - V_{ROUT(T)}.



[查询XCM519供应商](#)

■ DROPOUT VOLTAGE CHART (Continued)

| NOMINAL OUTPUT VOLTAGE (V) | E-4 | | | | | | | | | | | | | | |
|----------------------------|---------------------------|------------------------------------|----------|---------------------------|---------------------|----------|---------------------------|---------------------|----------|---------------------------|---------------------|----------|---------------------------|---------------------|----------|
| | DROPOUT VOLTAGE 4(mV) | | | | | | | | | | | | | | |
| | Vdif4 | | | | | | | | | | | | | | |
| | V _{BIAS} =3.0(V) | | | V _{BIAS} =3.3(V) | | | V _{BIAS} =3.6(V) | | | V _{BIAS} =4.2(V) | | | V _{BIAS} =5.0(V) | | |
| | V _{VROUT(T)} | V _{gs} ^(*) (V) | Vdif(mV) | | V _{gs} (V) | Vdif(mV) | | V _{gs} (V) | Vdif(mV) | | V _{gs} (V) | Vdif(mV) | | V _{gs} (V) | Vdif(mV) |
| TYP | | | MAX | TYP | | MAX | TYP | | MAX | TYP | | MAX | TYP | | MAX |
| 0.70 | 2.30 | 189 | 300 | 2.60 | 157 | 300 | 2.90 | 146 | 300 | 3.50 | 129 | 300 | 4.30 | 116 | 300 |
| 0.75 | 2.25 | 195 | 277 | 2.55 | 164 | 272 | 2.85 | 150 | 250 | 3.45 | 131 | 250 | 4.25 | 118 | 250 |
| 0.80 | 2.20 | | | 2.50 | | | 2.80 | | | 3.40 | | 4.20 | 231 | | |
| 0.85 | 2.15 | 201 | 277 | 2.45 | 170 | 272 | 2.75 | 153 | 250 | 3.35 | 134 | 246 | 4.15 | 119 | 231 |
| 0.90 | 2.10 | | | 2.40 | | | 2.70 | | | 3.30 | | 4.10 | | | |
| 0.95 | 2.05 | 206 | 277 | 2.35 | 189 | 272 | 2.65 | 157 | 250 | 3.25 | 136 | 246 | 4.05 | 121 | 231 |
| 1.00 | 2.00 | | | 2.30 | | | 2.60 | | | 3.20 | | 4.00 | | | |
| 1.05 | 1.95 | 218 | 277 | 2.25 | 195 | 272 | 2.55 | 164 | 250 | 3.15 | 139 | 246 | 3.95 | 125 | 231 |
| 1.10 | 1.90 | | | 2.20 | | | 2.50 | | | 3.10 | | 3.90 | | | |
| 1.15 | 1.85 | 231 | 227 | 2.15 | 201 | 272 | 2.45 | 170 | 250 | 3.05 | 142 | 246 | 3.85 | 128 | 231 |
| 1.20 | 1.80 | | 334 | 2.10 | | 277 | 2.40 | | 248 | 3.00 | | 215 | 3.80 | | 189 |
| 1.25 | 1.75 | 248 | 376 | 2.05 | 206 | 296 | 2.35 | 189 | 255 | 2.95 | 146 | 219 | 3.75 | 128 | 191 |
| 1.30 | 1.70 | | | 2.00 | | | 2.30 | | | 2.90 | | | 3.70 | | |
| 1.35 | 1.65 | 264 | 418 | 1.95 | 218 | 315 | 2.25 | 195 | 266 | 2.85 | 150 | 224 | 3.65 | 129 | 193 |
| 1.40 | 1.60 | | | 1.90 | | | 2.20 | | | 2.80 | | | 3.60 | | |
| 1.45 | 1.55 | 281 | 460 | 1.85 | 231 | 334 | 2.15 | 201 | 277 | 2.75 | 153 | 228 | 3.55 | 129 | 195 |
| 1.50 | 1.50 | | | 1.80 | | | 2.10 | | | 2.70 | | | 3.50 | | |
| 1.55 | 1.45 | - | - | 1.75 | 248 | 376 | 2.05 | 206 | 296 | 2.65 | 157 | 234 | 3.45 | 131 | 198 |
| 1.60 | 1.40 | | | 1.70 | | | 2.00 | | | 2.60 | | | 3.40 | | |
| 1.65 | 1.35 | - | - | 1.65 | 264 | 418 | 1.95 | 218 | 315 | 2.55 | 164 | 241 | 3.35 | 134 | 202 |
| 1.70 | 1.30 | | | 1.60 | | | 1.90 | | | 2.50 | | | 3.30 | | |
| 1.75 | 1.25 | - | - | 1.55 | 281 | 460 | 1.85 | 231 | 334 | 2.45 | 170 | 248 | 3.25 | 136 | 205 |
| 1.80 | 1.20 | | | 1.50 | | | 1.80 | | | 2.40 | | | 3.20 | | |

*1): V_{gs} is a Gate –Source voltage of the driver transistor that is defined as the value of V_{BIAS} - V_{ROUT(T)}.

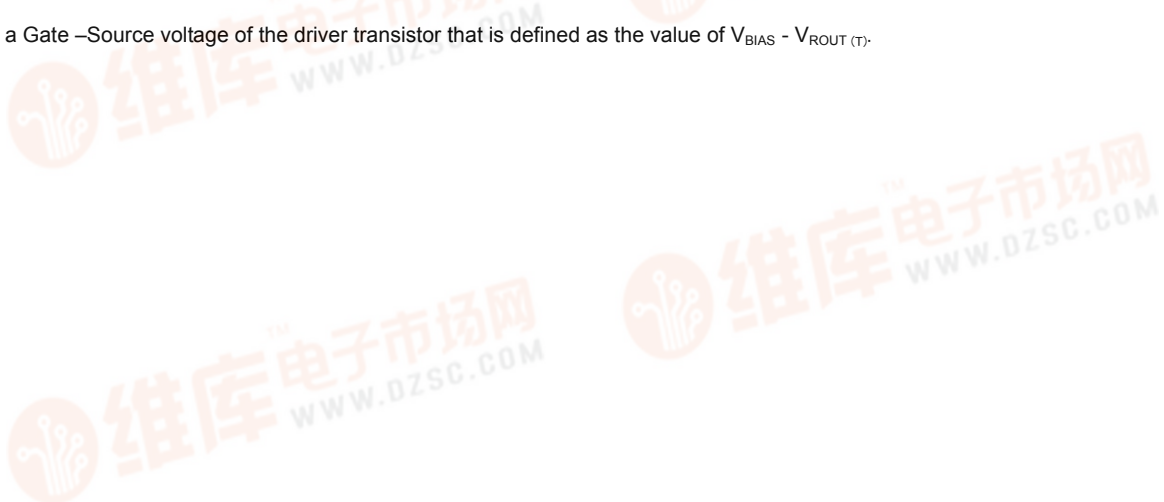

■ TYPICAL APPLICATION CIRCUIT

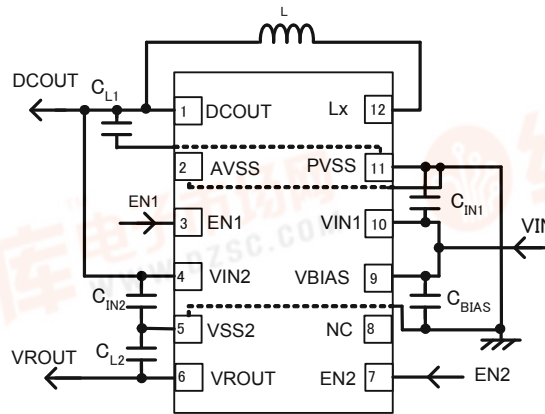

● DC/DC BLOCK $f_{OSC}=3.0\text{MHz}$

| | | | |
|-------|---|-------------------|----------------------|
| L | : | 1.5 μH | (NR3015 TAIYO YUDEN) |
| CIN1 | : | 10 μF | (Ceramic) |
| CL1 | : | 10 μF | (Ceramic) |
| CBIAS | : | 1 μF | (Ceramic) |
| CIN2 | : | 1 μF | (Ceramic) |
| CL2 | : | 4.7 μF | (Ceramic) |

● DC/DC BLOCK $f_{OSC}=1.2\text{MHz}$

| | | | |
|-------|---|-------------------|----------------------|
| L | : | 4.7 μH | (NR4018 TAIYO YUDEN) |
| CIN1 | : | 10 μF | (Ceramic) |
| CL1 | : | 10 μF | (Ceramic) |
| CBIAS | : | 1 μF | (Ceramic) |
| CIN2 | : | 1 μF | (Ceramic) |
| CL2 | : | 4.7 μF | (Ceramic) |

■ OPERATIONAL EXPLANATION

● DC/DC BLOCK

The DC/DC block of the XCM519 series consists of a reference voltage source, ramp wave circuit, error amplifier, PWM comparator, phase compensation circuit, output voltage adjustment resistors, P-channel MOSFET driver transistor, N-channel MOSFET switching transistor for the synchronous switch, current limiter circuit, UVLO circuit and others. (See the block diagram above.)

The series ICs compare, using the error amplifier, the voltage of the internal voltage reference source with the feedback voltage from the DCOUT pin through split resistors, R1 and R2. Phase compensation is performed on the resulting error amplifier output, to input a signal to the PWM comparator to determine the turn-on time during PWM operation. The PWM comparator compares, in terms of voltage level, the signal from the error amplifier with the ramp wave from the ramp wave circuit, and delivers the resulting output to the buffer driver circuit to cause the Lx pin to output a switching duty cycle. This process is continuously performed to ensure stable output voltage. The current feedback circuit monitors the P-channel MOS driver transistor current for each switching operation, and modulates the error amplifier output signal to provide multiple feedback signals. This enables a stable feedback loop even when a low ESR capacitor such as a ceramic capacitor is used ensuring stable output voltage.

<Reference Voltage Source>

The reference voltage source provides the reference voltage to ensure stable output voltage of the DC/DC converter.

<Ramp Wave Circuit>

The ramp wave circuit determines switching frequency. The frequency is fixed internally and can be selected from 1.2MHz or 3.0MHz. Clock pulses generated in this circuit are used to produce ramp waveforms needed for PWM operation, and to synchronize all the internal circuits.

<Error Amplifier>

The error amplifier is designed to monitor output voltage. The amplifier compares the reference voltage with the feedback voltage divided by the internal split resistors, R1 and R2. When a voltage is lower than the reference voltage is fed back, the output voltage of the error amplifier increases. The gain and frequency characteristics of the error amplifier output are fixed internally to deliver an optimized signal to the mixer.

查询XCM519供应商

OPERATIONAL EXPLANATION (Continued)

<Current Limit>

The current limiter circuit of the XCM519 series monitors the current flowing through the P-channel MOS driver transistor connected to the Lx pin, and features a combination of the current limit mode and the operation suspension mode.

- ① When the driver current is greater than a specific level, the current limit function operates to turn off the pulses from the Lx pin at any given timing.
- ② When the P-channel MOS driver transistor is turned off, the limiter circuit is then released from the current limit detection state.
- ③ At the next pulse, the P-channel MOS driver transistor is turned on. However, the P-channel MOS driver transistor is immediately turned off in the case of an over current state.
- ④ When the over current state is eliminated, the IC resumes its normal operation.

The IC waits for the over current state to end by repeating the steps ① through ③. If an over current state continues for a few ms and the above three steps are repeatedly performed, the IC performs the function of latching the OFF state of the P-channel MOS driver transistor, and goes into operation suspension mode. Once the IC is in suspension mode, operations can be resumed by either turning the IC off via the CE/MODE pin, or by restoring power to the V_{IN} pin. The suspension mode does not mean a complete shutdown, but a state in which pulse output is suspended; therefore, the internal circuitry remains in operation. The current limit of the XCM519 series can be set at 1050mA at typical. Besides, care must be taken when laying out the PC Board, in order to prevent miss-operation of the current limit mode. Depending on the state of the PC Board, latch time may become longer and latch operation may not work. In order to avoid the effect of noise, the board should be laid out so that input capacitors are placed as close to the IC as possible.

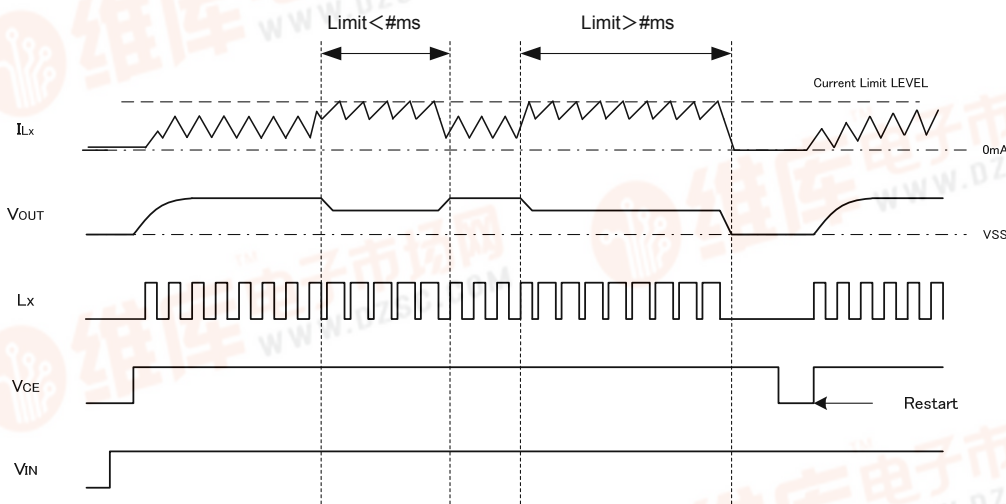

<Short-Circuit Protection>

The short-circuit protection circuit monitors the internal R1 and R2 divider voltage from the DCOUT pin. In case where output is accidentally shorted to the Ground and when the FB point voltage decreases less than half of the reference voltage (V_{ref}) and a current more than the I_{LIM} flows to the P-channel MOS driver transistor, the short-circuit protection quickly operates to turn off and to latch the P-channel MOS driver transistor. In latch state, the operation can be resumed by either turning the IC off and on via the EN1 pin, or by restoring power supply to the V_{IN1} pin.

When sharp load transient happens, a voltage drop at the DCOUT pin is propagated to FB point through C_{FB} , as a result, short circuit protection may operate in the voltage higher than $1/2 V_{OUT}$ voltage.

<UVLO Circuit>

When the V_{IN1} pin voltage becomes 1.4V or lower, the P-channel MOS driver transistor is forced OFF to prevent false pulse output caused by unstable operation of the internal circuitry. When the V_{IN1} pin voltage becomes 1.8V or higher, switching operation takes place. By releasing the UVLO function, the IC performs the soft start function to initiate output startup operation. The soft start function operates even when the V_{IN} pin voltage falls momentarily below the UVLO operating voltage. The UVLO circuit does not cause a complete shutdown of the IC, but causes pulse output to be suspended; therefore, the internal circuitry remains in operation.

OPERATIONAL EXPLANATION (Continued)

<PFM Switch Current>

In the PFM control operation, until coil current reaches to a specified level (D_{LIMIT_PFM}), the IC keeps the P-channel MOS driver transistor on. In this case, on-time (t_{ON}) that the P-channel MOS driver transistor is kept on can be given by the following formula.

$$t_{ON} = L \times I_{PFM} (V_{IN1} - V_{DCOUT}) \rightarrow I_{PFM} \textcircled{1}$$

<PFM duty Limit>

In the PFM control operation, the PFM duty limit (D_{LIMIT_PFM}) is set to 200% (TYP.). Therefore, under the condition that the duty increases (e.g. the condition that the step-down ratio is small), it's possible for P-channel MOS driver transistor to be turned off even when coil current doesn't reach to I_{PFM} . $\rightarrow I_{PFM} \textcircled{2}$

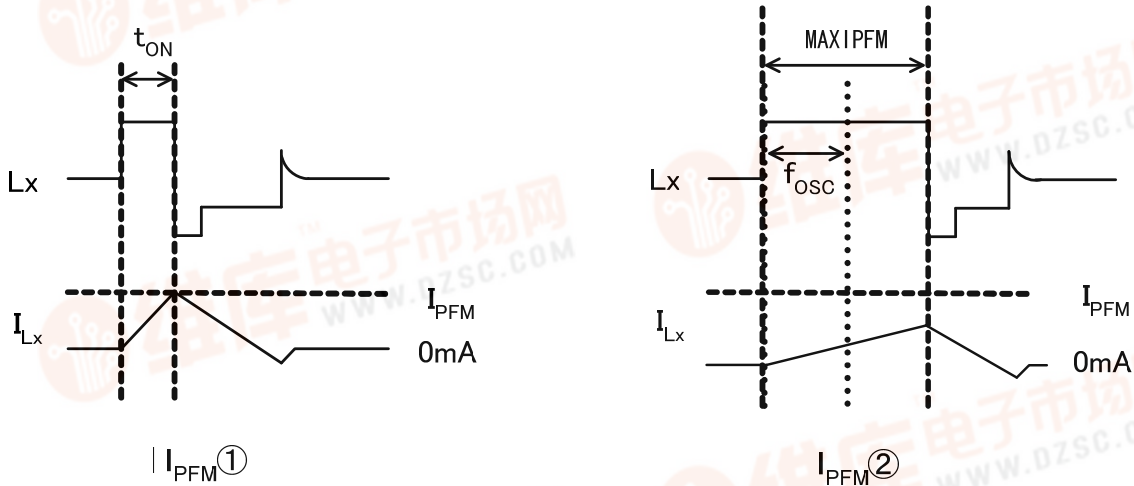

<C_L High Speed Discharge>

XCM519xC/ XCM519xD series can quickly discharge the electric charge at the output capacitor (C_L) when a low signal to the CE pin which enables a whole IC circuit put into OFF state, is inputted via the N-channel MOSFET switching transistor located between the L_x pin and the V_{SS} pin. When the IC is disabled, electric charge at the output capacitor (C_L) is quickly discharged so that it may avoid application malfunction. Discharge time of the output capacitor (C_L) is set by the C_L auto-discharge resistance (R) and the output capacitor (C_L). By setting time constant of a C_L auto-discharge resistance value [R] and an output capacitor value (C_L) as

τ ($\tau = C \times R$), discharge time of the output voltage after discharge via the N channel transistor is calculated by the following formula.

$$V = V_{DCOUT(T)} \times e^{-t/\tau} \text{ or } t = \tau \ln (DCOUT(E) / V)$$

V : Output voltage after discharge

$V_{DCOUT(T)}$: Output voltage

t: Discharge time

$$\tau : C \times R$$

C= Capacitance of Output capacitor (C_L)

R= C_L auto-discharge resistance

Output Voltage Discharge Characteristics
Rdischg = 300Ω (TYP)

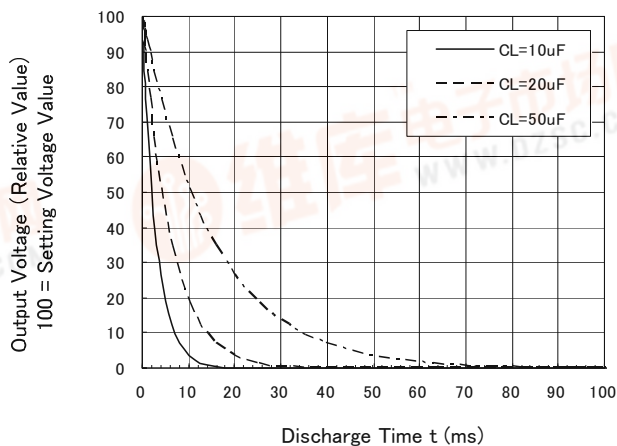

查询XCM519供应商

OPERATIONAL EXPLANATION (Continued)

● Voltage Regulator BLOCK

The voltage divided by resistors R1 & R2 is compared with the internal reference voltage by the error amplifier. The N-channel MOSFET which is connected to the V_{ROUT} pin is then driven by the subsequent output signal. The output voltage at the V_{ROUT} pin is controlled & stabilized by a system of negative feedback.

V_{BIAS} pin is power supply pin for output voltage control circuit, protection circuit and CE circuit. When output current increase, the V_{BIAS} pin supplies output current also. V_{IN2} pin is connected to a driver transistor and provides output current.

In order to obtain high efficient output current through low on-resistance, please take enough V_{gs} ($=V_{BIAS} - V_{ROUT(T)}$) of the driver transistor. Output current triggers operation of constant current limiter and fold-back circuit, heat generation triggers operation of thermal shutdown circuit, the driver transistor circuit is forced OFF when V_{BIAS} or V_{IN2} voltage goes lower than UVLO voltage. Further, the IC's internal circuitry can be shutdown via the EN2 pin's signal.

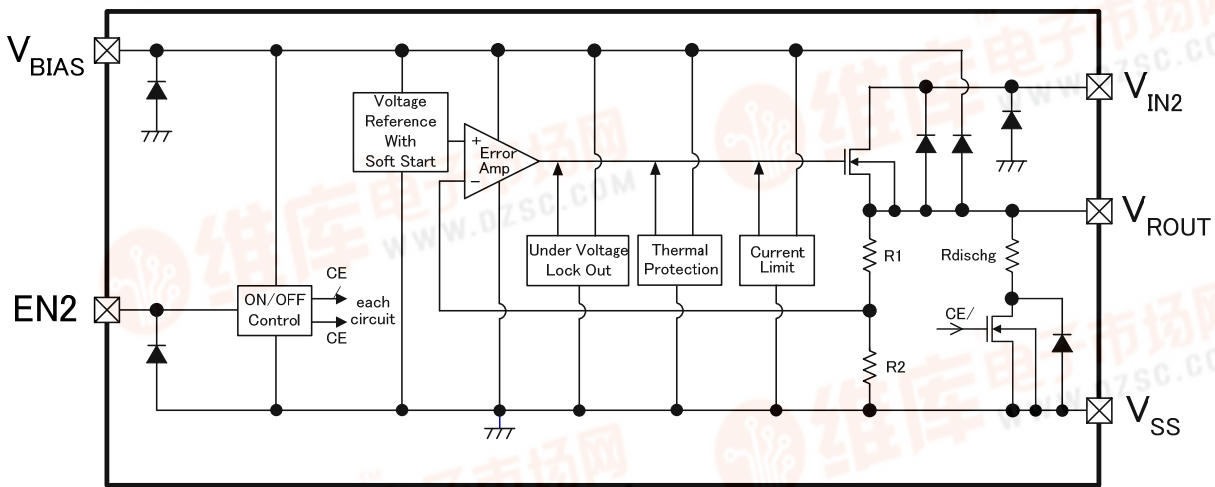

Figure 1: XC6601B Series

<Low ESR Capacitor>

With the XCM519 series, a stable output voltage is achievable even if used with low ESR capacitors, as a phase compensation circuit is built-in. The output capacitor (C_{L2}) should be connected as close to V_{ROUT} pin and V_{SS} pin to obtain stable phase compensation. Values required for the phase compensation are as the table below.

For a stable power input, please connect an bias capacitor (C_{BIAS}) of $1.0 \mu F$ between the V_{BIAS} pin and the V_{SS} pin. Also, please connect an input capacitor (C_{IN2}) of $1.0 \mu F$ between the V_{IN2} pin and the V_{SS} pin. In order to ensure the stable phase compensation while avoiding run-out of values, please use the capacitor (C_{BIAS} , C_{IN2} , C_{L2}) which does not depend on bias or temperature too much. The table below shows recommended values of C_{BIAS} , C_{IN2} , C_{L2} .

| NOMINAL VOLTAGE | BIAS CAPACITOR | INPUT CAPACITOR | OUTPUT CAPACITOR |
|-----------------|----------------------|---------------------|--------------------|
| | C_{BIAS} | C_{IN2} | C_{L2} |
| 0.7V~1.8V | $C_{BIAS}=1.0 \mu F$ | $C_{IN2}=1.0 \mu F$ | $C_{L2}=4.7 \mu F$ |

Recommended Values of C_{BIAS} , C_{IN2} , C_{L2}

OPERATIONAL EXPLANATION (Continued)

<Soft-start>

With the XCM519, the inrush current from V_{IN2} to V_{ROUT} for charging C_L at start-up can be reduced and makes the V_{IN2} stable. The soft-start time is optimized to 240 μ A (TYP.) at $V_{ROUT}=1.2$ V internally. Soft-start time is defined as the V_{ROUT} reaches 90% of $V_{ROUT(E)}$ from the time when CE H threshold 0.75V is input to the CE pin.

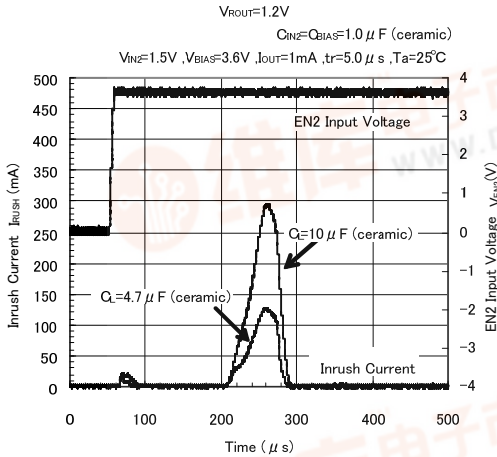

Figure2: Example of the inrush current wave form at IC start-up.

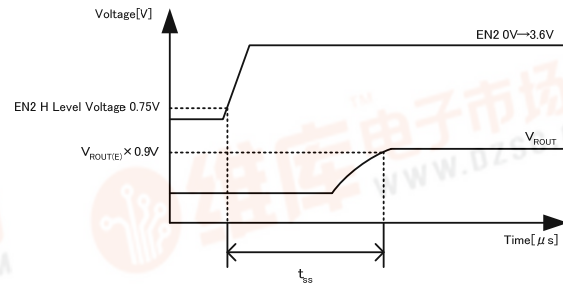

Figure3: Timing chart at IC start-up

<CL High Speed Auto-Discharge>

XCM519 series can quickly discharge the electric charge at the output capacitor (C_L) when a low signal to the EN2 pin which enables a whole IC circuit put into OFF state, is inputted via the N-channel transistor located between the V_{ROUT} pin and the V_{SS} pin. When the IC is disabled, electric charge at the output capacitor (C_L) is quickly discharged so that it could avoid malfunction. At that time, C_L discharge resistance is depended on a bias voltage. Discharge time of the output capacitor (C_L) is set by the C_L auto-discharge resistance (R) and the output capacitor (C_L). By setting time constant of a C_L auto-discharge resistance value [R] and an output capacitor value (C_L) as τ ($\tau = C \times R$), the output voltage after discharge via the N channel transistor is calculated by the following formulas.

$$V = V_{ROUT(E)} \times e^{-t/\tau}, \text{ or } t = \tau \ln(V_{ROUT(E)} / V)$$

V : Output voltage after discharge, $V_{ROUT(E)}$: Output voltage, t : Discharge time,

τ : C_L auto-discharge resistance $R \times$ Output capacitor (C_L) value C

<Current Limit, Short-Circuit Protection>

The XCM519 series' fold-back circuit operates as an output current limiter and a short protection of the output pin. When the load current reaches the current limit level, the fixed current limiter circuit operates and output voltage drops. When the output pin is shorted to the V_{SS} level, current flows about 50mA.

<Thermal Shutdown Circuit (TSD) >

When the junction temperature of the built-in driver transistor reaches the temperature limit level (150°C TYP.), the thermal shutdown circuit operates and the driver transistor will be set to OFF. The IC resumes its operation when the thermal shutdown function is released and the IC's operation is automatically restored because the junction temperature drops to the level of the thermal shutdown release temperature (135°C TYP.).

<Under Voltage Lock Out (UVLO) >

When the V_{BIAS} pin voltage drops below 2.0V (TYP.) or V_{IN2} pin voltage drops below 0.4V (TYP.), the output driver transistor is forced OFF by UVLO function to prevent false output caused by unstable operation of the internal circuitry. When the V_{BIAS} pin voltage rise at 2.2V (TYP.) or the V_{IN2} pin voltage rises at 0.4V (TYP.), the UVLO function is released. The driver transistor is turned in the ON state and start to operate voltage regulation.

■ 查询XCM519供应商 OPERATIONAL EXPLANATION (Continued)

<EN2 Pin>

The IC internal circuitry can be shutdown via the signal from the EN2 pin with the XCM519 series. In shutdown mode, output at the V_{ROUT} pin will be pulled down to the V_{SS} level via R1 & R2. However, as for the XCM519 series, the CL auto-discharge resistor is connected in parallel to R1 and R2 while the power supply is applied to the V_{IN2} pin. Therefore, time until the V_{ROUT} pin reaches the V_{SS} level becomes short.

The EN2 pin of XCM519 has pull-down circuitry so that EN2 input current increase during IC operation. The EN2 pin of XCM519 does not have pull-down circuitry so that logic is not fixed when the CE pin is open. If the EN2 pin voltage is taken from V_{BIAS} pin or V_{SS} pin then logic is fixed and the IC will operate normally. However, supply current may increase as a result of through current in the IC's internal circuitry when medium voltage is input.

■ NOTE ON USE

When the DC/DC converter and the VR are connected as V_{IN1}=V_{BIAS}, V_{DCOUT}=V_{IN2}, the following points should be noted.

1. When the DC/DC load is changed drastically during a light load of the VR, a fluctuation may happen in tenths of mV. This value can be reduced by increasing C_{L1} load capacitance at the DC/DC in order to reduce a voltage drop during load transient.

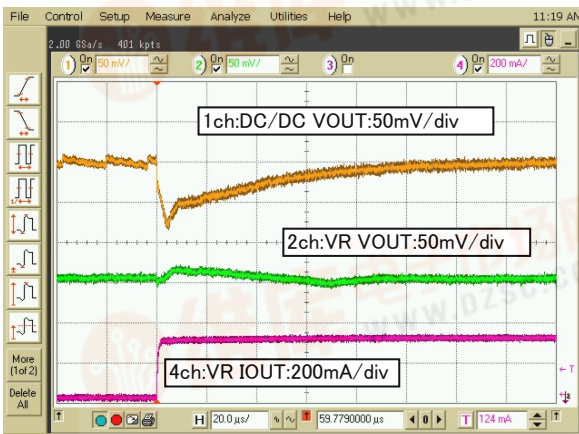

20 μ s/div

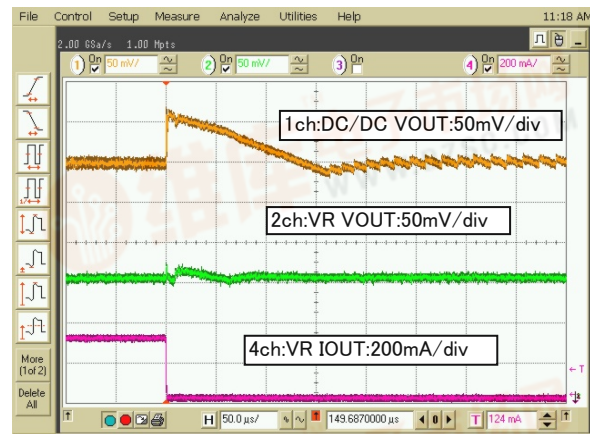

50 μ s/div

2. It is recommended that both C_{IN1} and C_{BIAS} are connected to each pin separately. When one capacitor is used instead of the two, this capacitor should be placed in 10 μ F or more as close as the VIN1 and the PGND (AGND) pins of the DC/DC circuit. Please ensure it by testing on the actual product design.
3. It is recommended that both C_{L1} and C_{IN2} are connected to each pin separately. When one capacitor is used instead of the two, this capacitor should be selected in 4.7 μ F or bigger. Please ensure it by testing on the actual product design.
4. C_{L2} of the VR is recommended 4.7 μ A. When larger value is used in C_{L2}, the larger value is also used in C_{L1} as in proportional. Please be noted that when C_{L2} capacitance of the VR is getting large, an inrush current increases at VR start-up, DC/DC short circuit protection starts to operate, as a result, the IC may happen to stop.

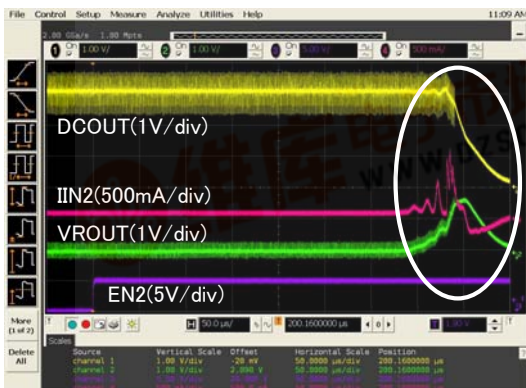

50us/div

* VR inrush current I_{IN2} makes DC/DC short-circuit protection to start, as a result, the IC may happen to stop.

The left waver forms are taken at C_{L1}=10 μ , C_{L2}=10 μ F(in contrast to the recommended 4.7 μ F).

However, it improves when C_{L1}=20 μ F.

NOTE ON USE (Continued)

- When the input-output voltage differential is small in the DC/DC converter and heavy load condition, a duty cycle is getting large and keeps the 100% duty cycle in a several period cycles. At the time of duty cycle transition to 100% or from 100%, noise may appear on the voltage regulator output. Please evaluate this on the actual design board when the condition is in small input-output voltage differential and heavy load.
- When the load is changed at the DC/DC converter, ringing may happen in some load conditions of DC/DC and VR at the timing of turn on and turn off. The ringing can be reduced by increasing C_{IN1} capacitance or placing a resistor over 10k Ω between V_{IN1} and V_{BIAS} pins.
- In order to turn off the input voltage, the EN2 pin should be turned off first. If the input voltage is turned off with keeping VR operation, the VROUT voltage goes up instantaneously as a result of the VR bias voltage transient.

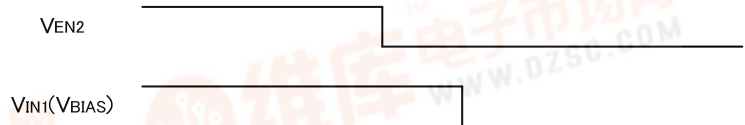
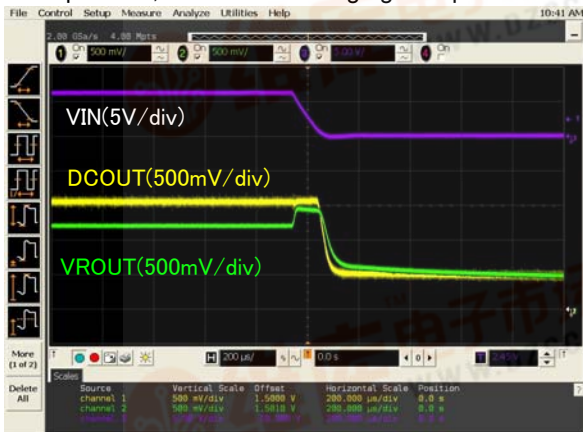

200us/div

- When the DCOUT pin is connected to the V_{IN2} pin and the bias voltage (V_{BIAS}) is taken from the other power supply, EN1 and EN2 should be started up 10 μ s later than V_{BIAS} . If EN1 and EN2 is turned on within 10 μ s, inrush current like 1A may happen which result in starting the DC/DC short-circuit protection.



- It is recommended to test this in the actual product design board.

<DC/DC BLOCK>

- The XCM519 series is designed for use with ceramic output capacitors. If, however, the potential difference is too large between the input voltage and the output voltage, a ceramic capacitor may fail to absorb the resulting high switching energy and oscillation could occur on the output. If the input-output potential difference is large, connect an electrolytic capacitor in parallel to compensate for insufficient capacitance.
- Spike noise and ripple voltage arise in a switching regulator as with a DC/DC converter. These are greatly influenced by external component selection, such as the coil inductance, capacitance values, and board layout of external components. Once the design has been completed, verification with actual components should be done.
- As a result of input-output voltage and load conditions, oscillation frequency goes to 1/2, 1/3, and continues, then a ripple may increase.
- When input-output voltage differential is large and light load conditions, a small duty cycle comes out. After that, 0% duty cycle may continue in several periods.
- When input-output voltage differential is small and heavy load conditions, a large duty cycle comes out and may continues 100% duty cycle in several periods.
- With the IC, the peak current of the coil is controlled by the current limit circuit. Since the peak current increases when dropout voltage or load current is high, current limit starts operation, and this can lead to instability. When peak current becomes high, please adjust the coil inductance value and fully check the circuit operation. In addition, please calculate the peak current according to the following formula:

$$I_{pk} = (V_{IN1} - V_{DCOUT}) \times \text{OnDuty} / (2 \times L \times f_{osc}) + I_{OUT}$$

L: Coil Inductance Value

f_{osc} : Oscillation Frequency

查询XCM519供应商

NOTE ON USE (Continued)

7. When the peak current which exceeds limit current flows within the specified time, the built-in P-channel MOS driver transistor turns off. During the time until it detects limit current and before the built-in P-channel MOS driver transistor can be turned off, the current for limit current flows; therefore, care must be taken when selecting the rating for the external components such as a coil.
8. Care must be taken when laying out the PC Board, in order to prevent misoperation of the current limit mode. Depending on the state of the PC Board, latch time may become longer and latch operation may not work. In order to avoid the effect of noise, the board should be laid out so that input capacitors are placed as close to the IC as possible.
9. Use of the IC at voltages below the recommended voltage range may lead to instability.
10. This IC should be used within the stated absolute maximum ratings in order to prevent damage to the device.
11. When the IC is used in high temperature, output voltage may increase up to input voltage level at no load because of the leak current of the P-channel MOS driver transistor.
12. The current limit is set to 1350mA (MAX.) at typical. However, the current of 1350mA or more may flow. In case that the current limit functions while the DCOUT pin is shorted to the GND pin, when P-channel MOS driver transistor is ON, the potential difference for input voltage will occur at both ends of a coil. For this, the time rate of coil current becomes large. By contrast, when N-channel MOS switching transistor is ON, there is almost no potential difference at both ends of the coil since the DCOUT pin is shorted to the GND pin. Consequently, the time rate of coil current becomes quite small. According to the repetition of this operation, and the delay time of the circuit, coil current will be converged on a certain current value, exceeding the amount of current, which is supposed to be limited originally. Even in this case, however, after the over current state continues for several ms, the circuit will be latched. A coil should be used within the stated absolute maximum rating in order to prevent damage to the device.
 - ① Current flows into P-channel MOS driver transistor to reach the current limit (ILIM).
 - ② The current of ILIM or more flows since the delay time of the circuit occurs during from the detection of the current limit to OFF of P-channel MOS driver transistor.
 - ③ Because of no potential difference at both ends of the coil, the time rate of coil current becomes quite small.
 - ④ Lx oscillates very narrow pulses by the current limit for several ms.
 - ⑤ The circuit is latched, stopping its operation.

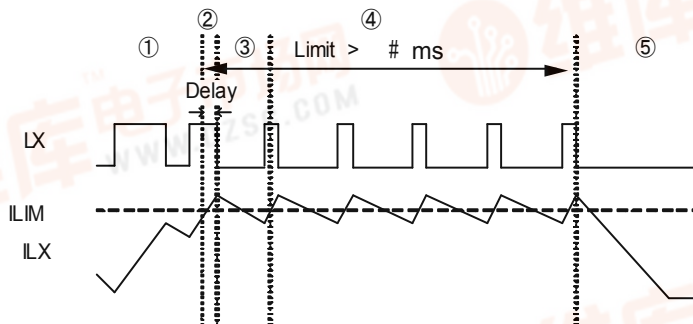

13. In order to stabilize V_{IN1} 's voltage level and oscillation frequency, we recommend that a by-pass capacitor (C_{IN}) be connected as close as possible to the V_{IN1} & V_{SS} pins.
14. High step-down ratio and very light load may lead an intermittent oscillation.
15. During PWM / PFM automatic switching mode, operating may become unstable at transition to continuous mode. Please verify with actual parts.

VOUT=3.3V, FOSC=1.2MHz
VIN=3.7V, IOUT=100mA

CH1:Lx 5/div

CH2:VOUT 20mV/div



<External Components>
L : 4.7 μ H (NR4018)
CIN : 4.7 μ F (Ceramic)
CL : 10 μ F (Ceramic)

NOTE ON USE (Continued)

16. Please note the inductance value of the coil. The IC may enter unstable operation if the combination of ambient temperature, setting voltage, oscillation frequency, and L value are not adequate. In the operation range close to the maximum duty cycle, The IC may happen to enter unstable output voltage operation even if using the L values listed below.

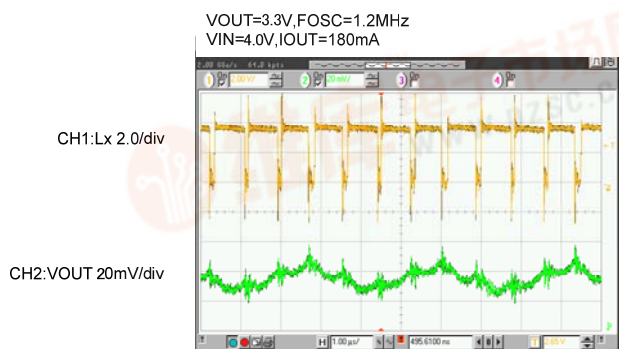

The Range of L Value

| f_{OSC} | V_{OUT} | L Value |
|-----------|-------------------------|----------------------------|
| 3.0MHz | $0.8V < V_{OUT} < 4.0V$ | $1.0 \mu H \sim 2.2 \mu H$ |
| 1.2MHz | $V_{OUT} \leq 2.5V$ | $3.3 \mu H \sim 6.8 \mu H$ |
| | $2.5V < V_{OUT}$ | $4.7 \mu H \sim 6.8 \mu H$ |

*When a coil less value of $4.7 \mu H$ is used at $f_{OSC}=1.2MHz$ or when a coil less value of $1.5 \mu H$ is used at $f_{OSC}=3.0MHz$, peak coil current more easily reach the current limit I_{LMI} . In this case, it may happen that the IC can not provide 600mA output current.

<Regulator BLOCK>

- Where wiring impedance is high, operations may become unstable due to noise and/or phase lag depending on output current. Please keep the resistance low between V_{BIAS} , V_{IN2} and V_{SS} wiring in particular.
- Please wire the bias capacitor (C_{BIAS}), input capacitor (C_{IN2}) and the output capacitor (C_{L2}) as close to the IC as possible.
- Capacitance values of these capacitors (C_{BIAS} , C_{IN2} , C_{L2}) are decreased by the influences of bias voltage and ambient temperature. Care shall be taken for capacitor selection to ensure stability of phase compensation from the point of ESR influence.
- In case of the output capacitor more than $C_L=22 \mu F$ is used, ringing of input current occurs when rising time.
- V_{IN2} and $EN2$ should be applied at least $10 \mu s$ after the bias voltage V_{BIAS} reaches the requested voltage. If V_{IN2} and $EN2$ are applied within $10 \mu s$, inrush current like 1A may occurs.

Instructions of pattern layouts

- Please use this IC within the stated absolute maximum ratings. The IC is liable to malfunction should the ratings be exceeded.
- In order to stabilize $V_{IN1} \cdot V_{IN2} \cdot V_{BIAS} \cdot DCOUT \cdot V_{ROUT}$ voltage level, we recommend that a by-pass capacitor ($C_{IN1} \cdot C_{IN2} \cdot C_{BIAS} \cdot C_{L1} \cdot C_{L2}$) be connected as close as possible to the $V_{IN1} \cdot V_{IN2} \cdot V_{BIAS} \cdot DCOUT \cdot V_{ROUT}$ and $GND \cdot V_{SS}$ pins.
- Please mount each external component as close to the IC as possible.
- Wire external components as close to the IC as possible and use thick, short connecting traces to reduce the circuit impedance.
- V_{SS} (AGND \cdot PGND \cdot V_{SS}) ground wiring is recommended to get large area. The IC may goes into unstable operation as a result of V_{SS} voltage level fluctuation during the switching.
- This series' internal driver transistors bring on heat because of the output current (I_{OUT}) and ON resistance of driver transistors.

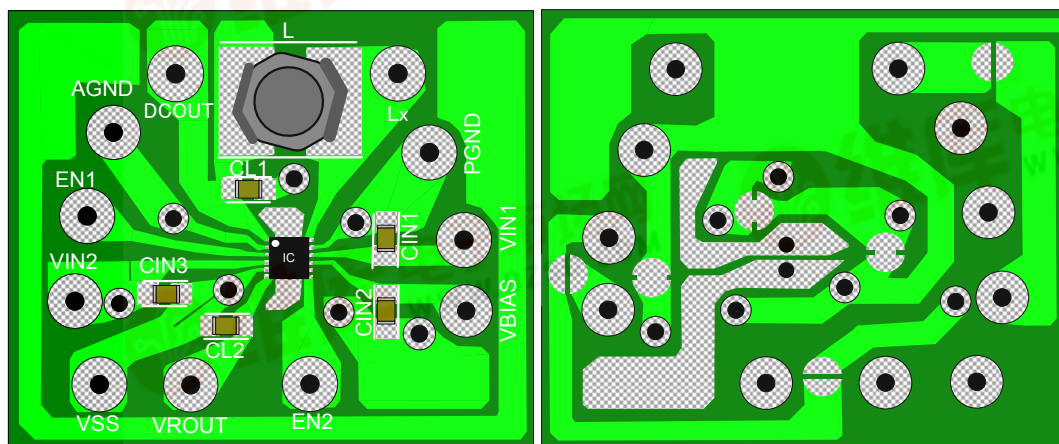

Front

Back

查询XCM519供应商

TEST CIRCUITS

< Circuit No.1 >

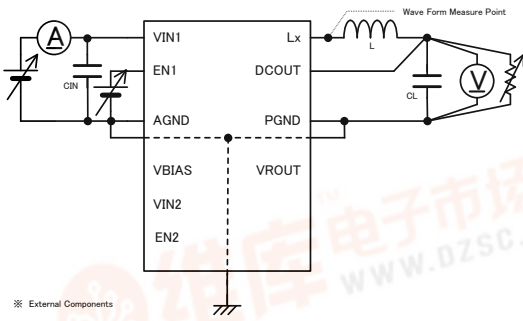

※ External Components
 L : 1.5 μ H (NFR3015) 3.0MHz
 4.7 μ H (NFR4018) 1.2MHz
 CIN : 4.7 μ F (ceramic)
 CL : 10 μ F (ceramic)

< Circuit No.2 >

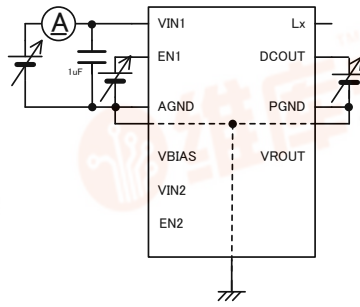

< Circuit No.3 >

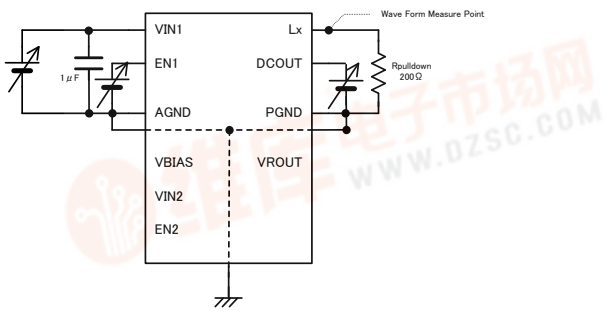

< Circuit No.4 >

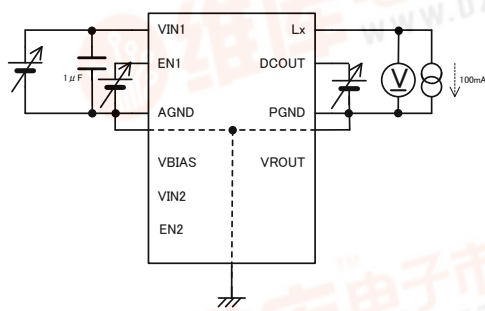

< Circuit No.5 >

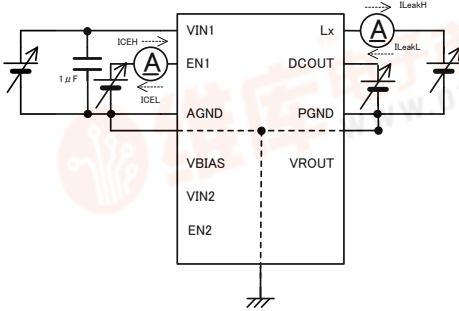

< Circuit No.6 >

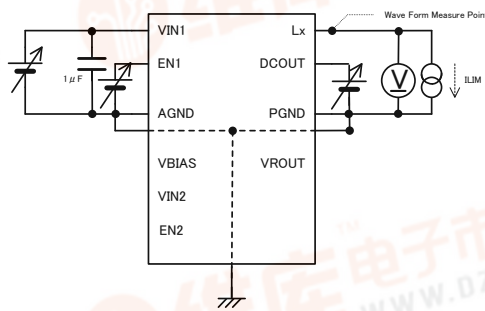

< Circuit No.7 >

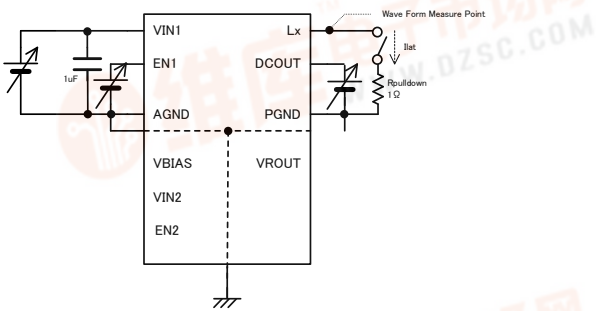

< Circuit No.8 >

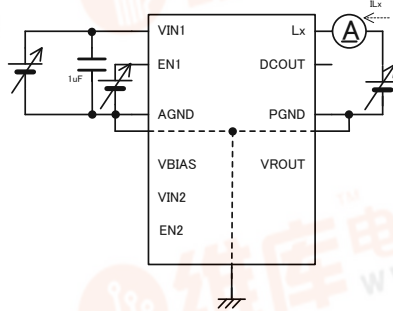

< Circuit No.9 >

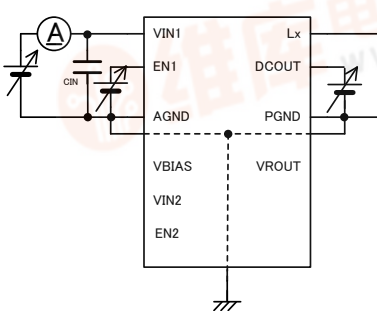

TEST CIRCUITS (Continued)

< Circuit No.10 >

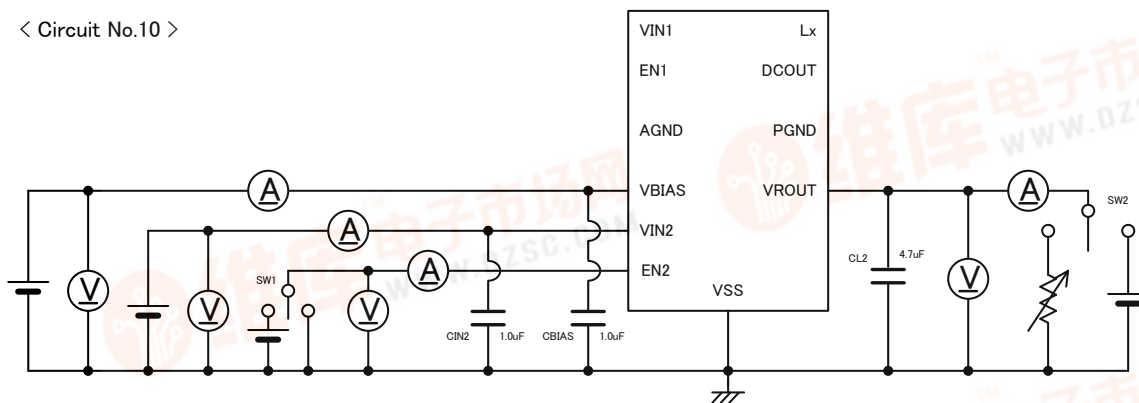

< Circuit No.11 >

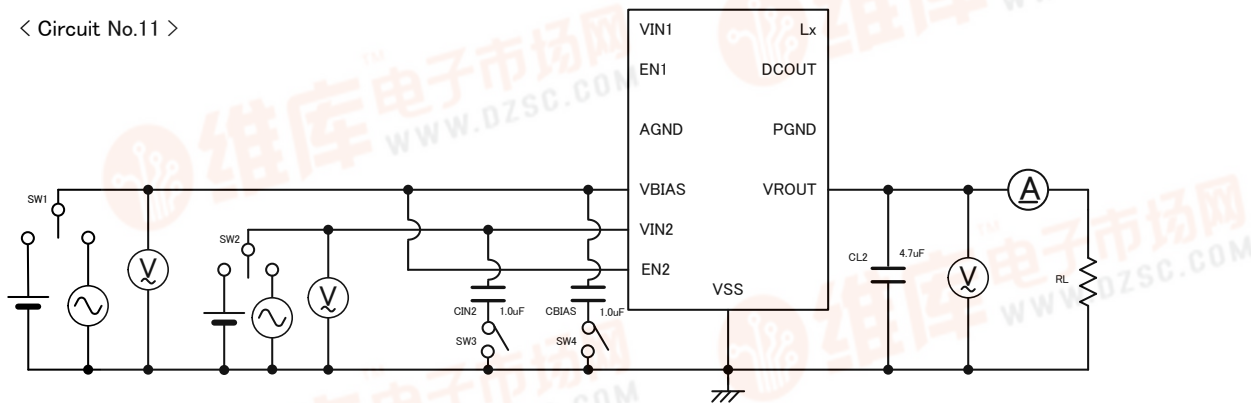

< Circuit No.12 >

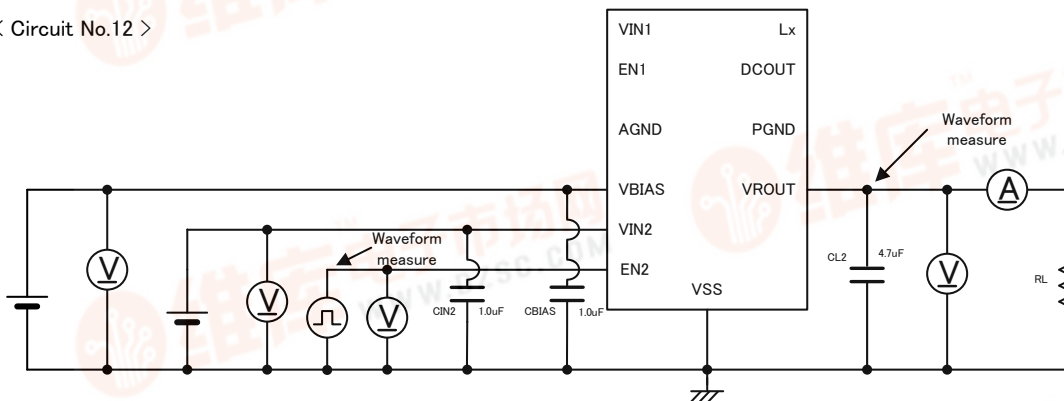

* For the timing chart, please refer to <Soft-start> on page 20.

查询XCM519供应商

TYPICAL PERFORMANCE CHARACTERISTICS

● 1ch:DC/DC Block

(1) Efficiency vs. Output Current

DCOUT=1.8V,1.2MHz

L=4.7 μ H(NR4018), C_{IN1}=10 μ F, C_{L1}=10 μ F

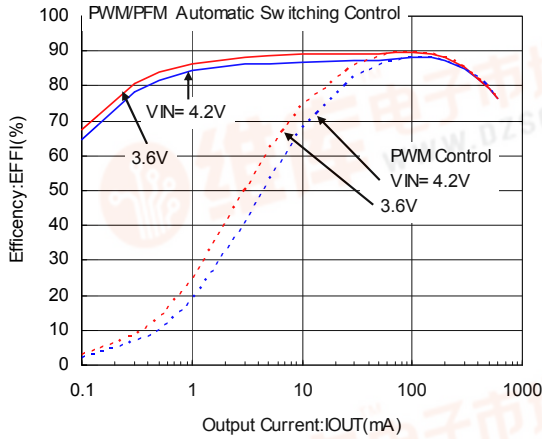

DCOUT=1.8V,3.0MHz

L=1.5 μ H(NR3015), C_{IN1}=10 μ F, C_{L1}=10 μ F

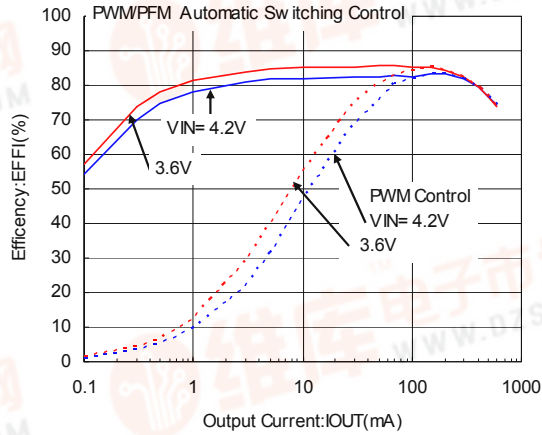

(2) Output Voltage vs. Output Current

DCOUT=1.8V,1.2MHz

L=4.7 μ H(NR4018), C_{IN1}=10 μ F, C_{L1}=10 μ F

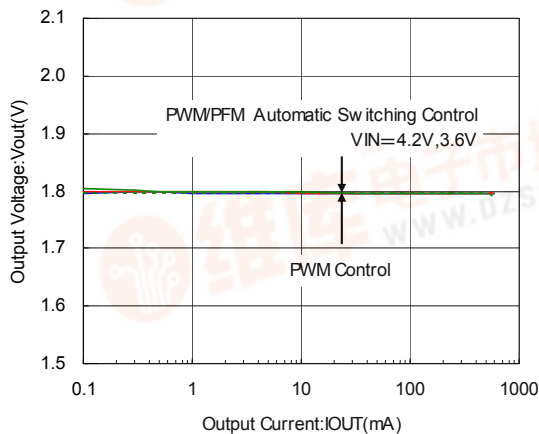

DCOUT=1.8V,3.0MHz

L=1.5 μ H(NR3015), C_{IN1}=10 μ F, C_{L1}=10 μ F

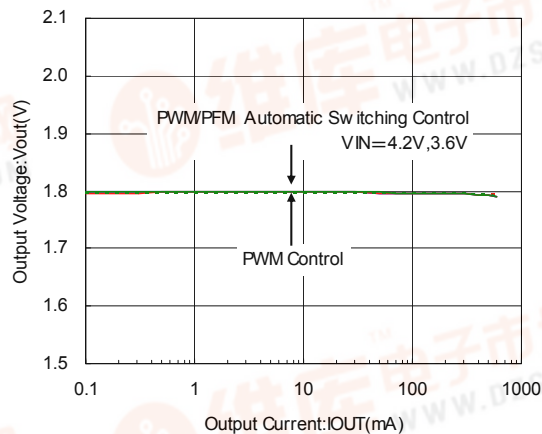

(3) Ripple Voltage vs. Output Current

DCOUT=1.8V,1.2MHz

L=4.7 μ H(NR4018), C_{IN1}=10 μ F, C_{L1}=10 μ F

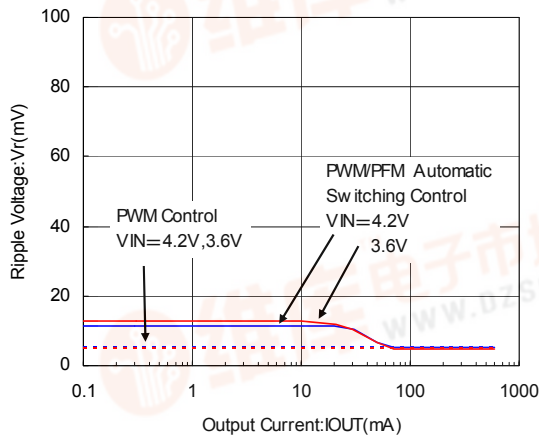

DCOUT=1.8V,3.0MHz

L=1.5 μ H(NR3015), C_{IN1}=10 μ F, C_{L1}=10 μ F

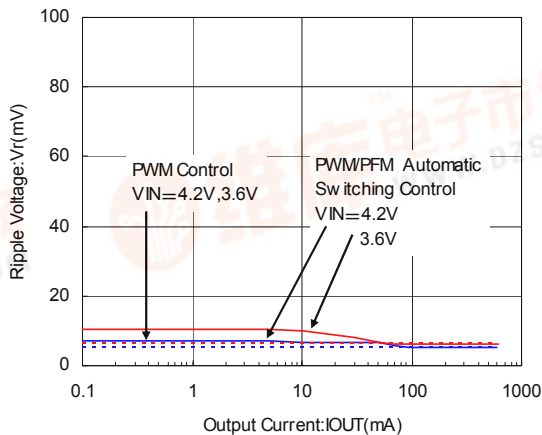

TYPICAL PERFORMANCE CHARACTERISTICS (Continued)

(4) Oscillation Frequency vs. Ambient Temperature

DCOUT=1.8V,1.2MHz

L=4.7 μH(NR4018), C_{IN1}=10 μF, C_{L1}=10 μF

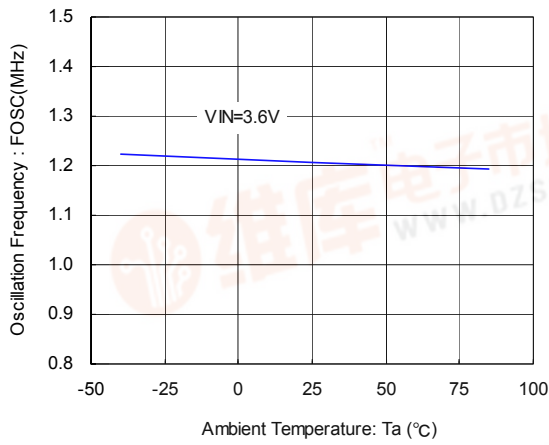

DCOUT=1.8V,3.0MHz

L=1.5 μH(NR3015), C_{IN1}=10 μF, C_{L1}=10 μF

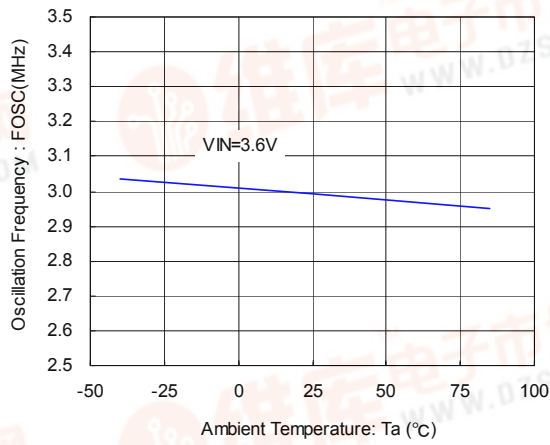

(5) Supply Current vs. Ambient Temperature

DCOUT=1.8V,1.2MHz

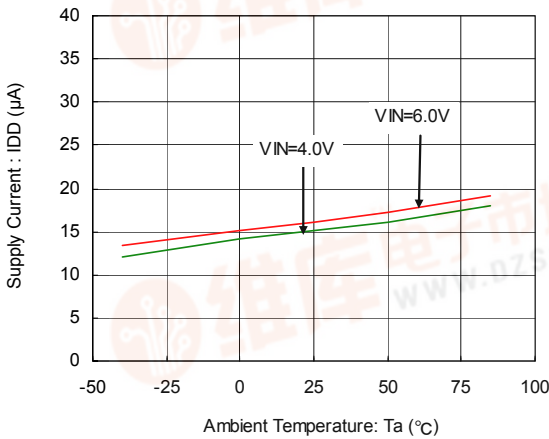

DCOUT=1.8V,3.0MHz

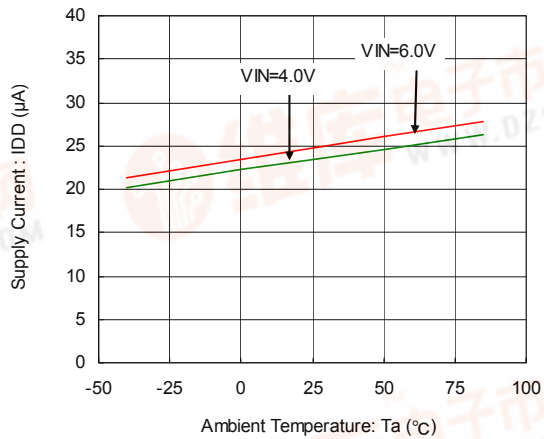

(6) Output Voltage vs. Ambient Temperature

DCOUT=1.8V,3.0MHz

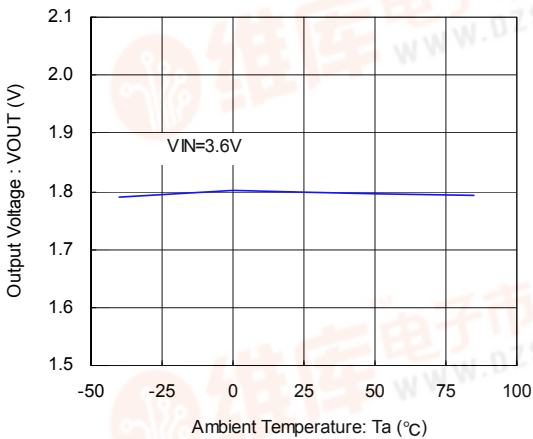

(7) UVLO Voltage vs. Ambient Temperature

DCOUT=1.8V,3.0MHz

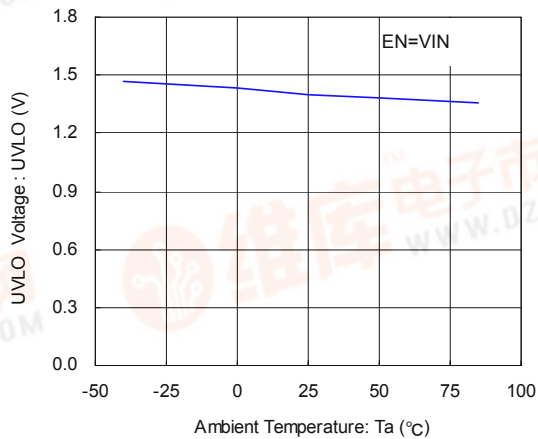

[查询XCM519供应商](#)

TYPICAL PERFORMANCE CHARACTERISTICS (Continued)

(8) EN "H" Voltage vs. Ambient Temperature
DCOUT=1.8V,3.0MHz

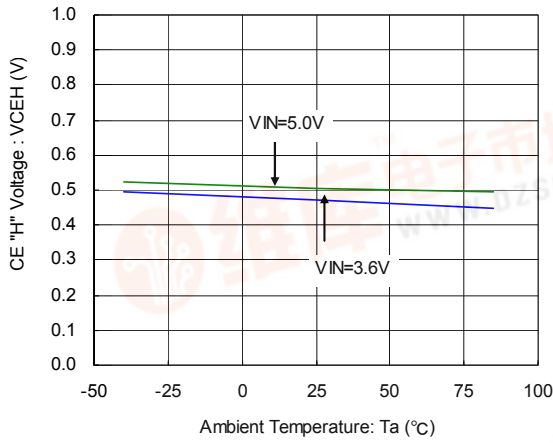

(9) EN "L" Voltage vs. Ambient Temperature
DCOUT=1.8V,3.0MHz

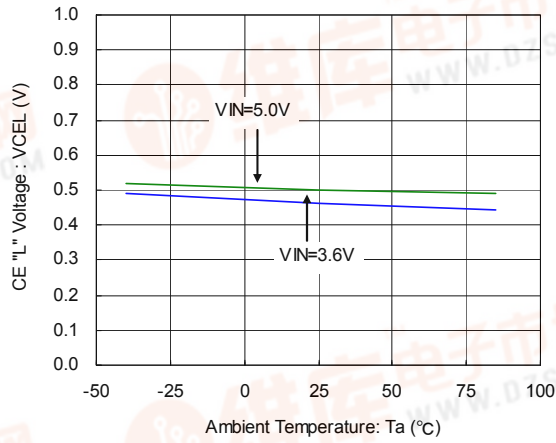

(10) Soft Start Time vs. Ambient Temperature
DCOUT=1.8V,3.0MHz

L=4.7 μH(NR4018), CIN1=10 μF, CL1=10 μF

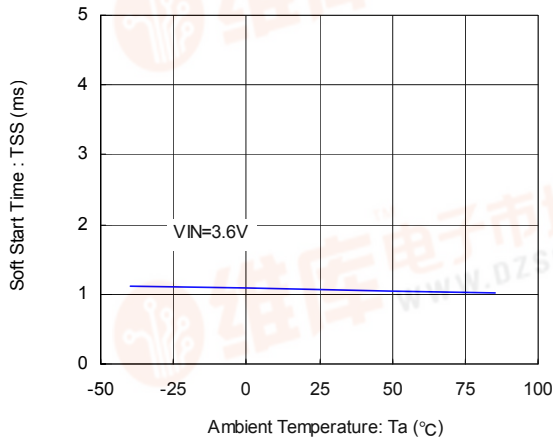

DCOUT=1.8V,3.0MHz

L=1.5 μH(NR3015), CIN1=10 μF, CL1=10 μF

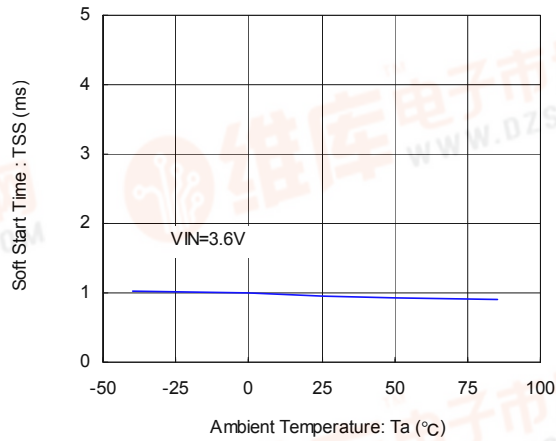

(11) "Pch / Nch" Driver on Resistance vs. Input Voltage
DCOUT=1.8V,3.0MHz

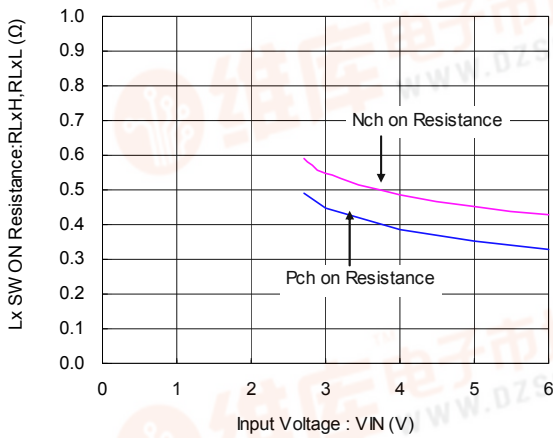

TYPICAL PERFORMANCE CHARACTERISTICS (Continued)

(12) XCM519xC/ XCM519xD Rise Wave Form

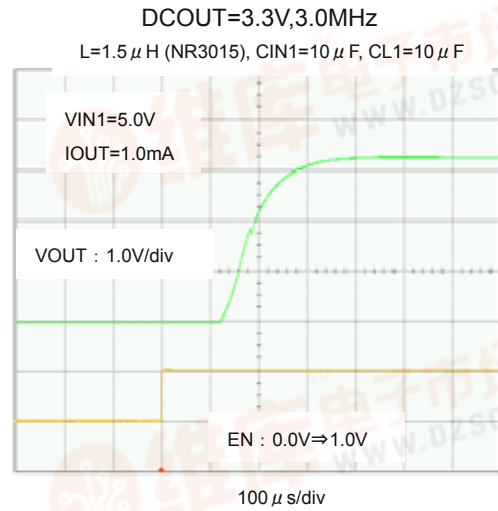
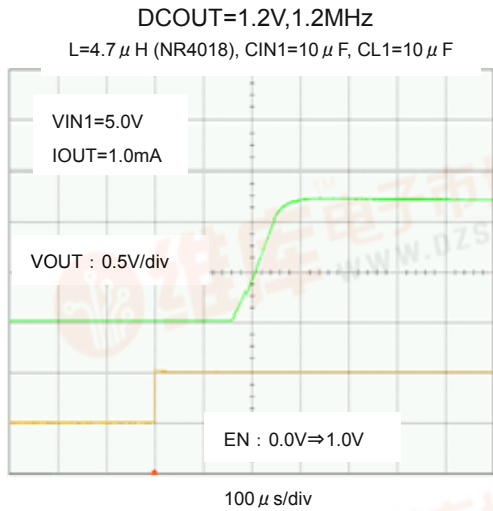

(13) XCM519xC/ XCM519xD Soft-Start Time vs. Ambient Temperature

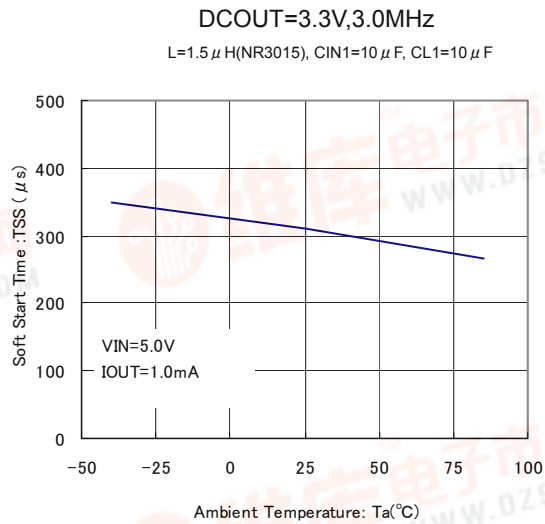
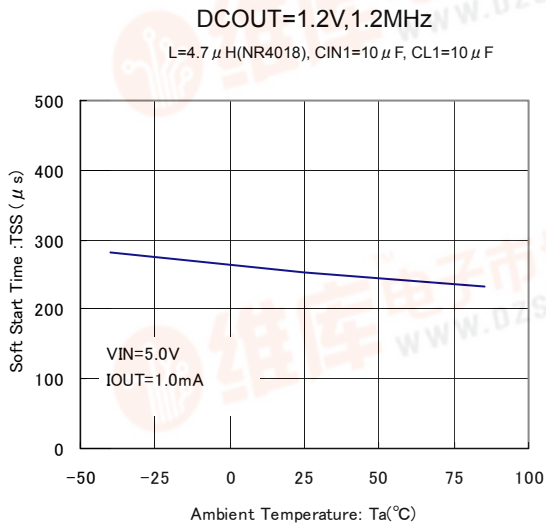

(14) XCM519xC/ XCM519xD CL Discharge Resistance vs. Ambient Temperature

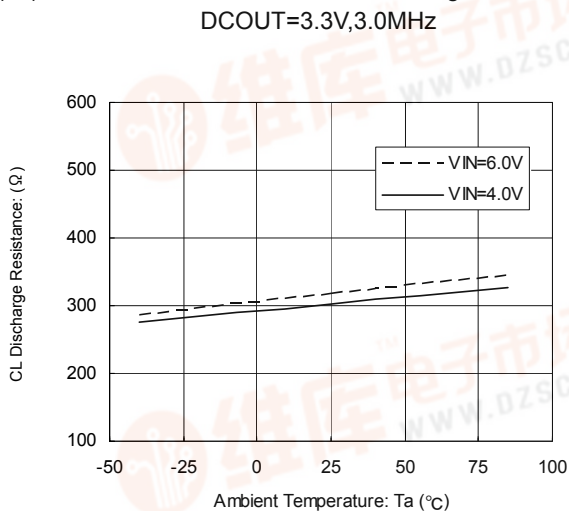

[查询XCM519供应商](#)

■ TYPICAL PERFORMANCE CHARACTERISTICS (Continued)

(15) Load Transient Response

DCOUT=1.2V, 1.2MHz(PWM/PFM Automatic Switching Control)

L=4.7 μ H(NR4018), C_{IN1}=10 μ F(ceramic), C_{L1}=10 μ F(ceramic), Topr=25°C

V_{IN1}=3.6V, EN1=V_{IN1}

I_{OUT}=1mA \rightarrow 100mA

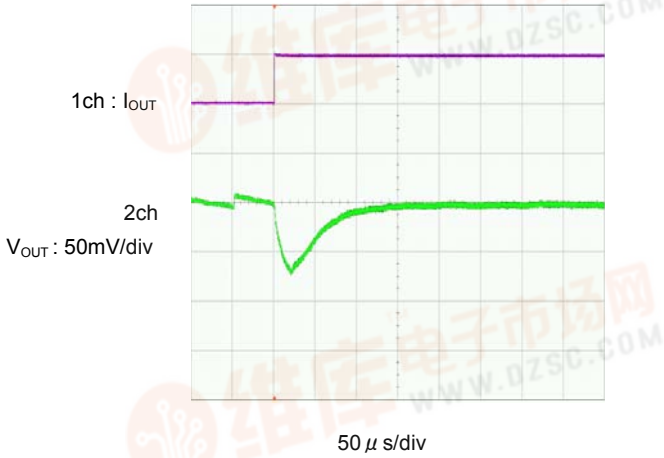

I_{OUT} =1mA \rightarrow 300mA

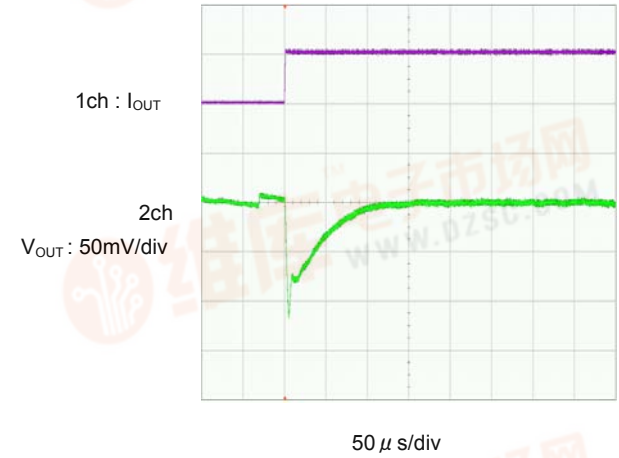

I_{OUT}=100mA \rightarrow 1mA

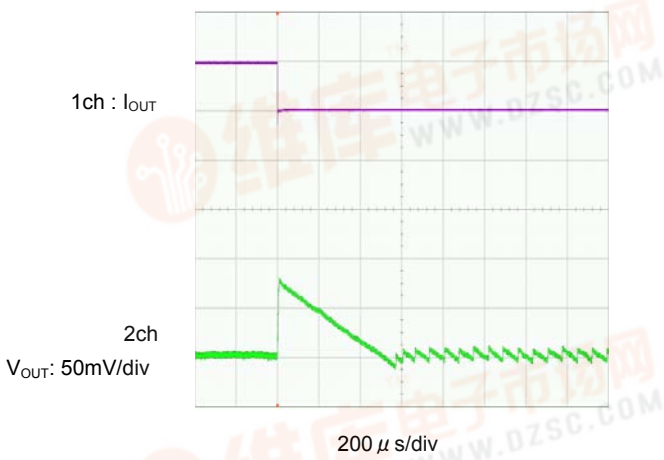

I_{OUT}=300mA \rightarrow 1mA

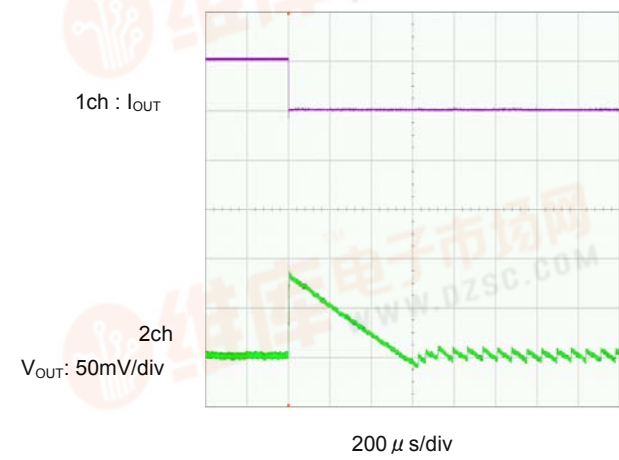

XCM519 Series

[查询XCM519供应商](#)

TYPICAL PERFORMANCE CHARACTERISTICS (Continued)

(15) Load Transient Response (Continued)

DCOUT=1.2V, 1.2MHz(PWM Control)

L=4.7 μ H(NR4018), C_{IN1}=10 μ F(ceramic), C_{L1}=10 μ F(ceramic), Topr=25°C

V_{IN1}=3.6V, EN1=V_{IN1}

I_{OUT}=1mA \rightarrow 100mA

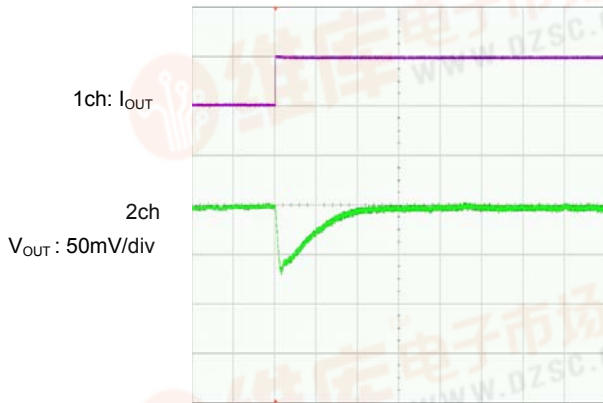

I_{OUT}=1mA \rightarrow 300mA

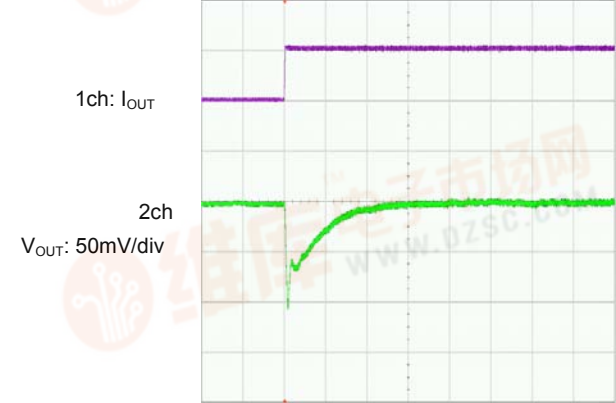

I_{OUT}=100mA \rightarrow 1mA



I_{OUT}=300mA \rightarrow 1mA

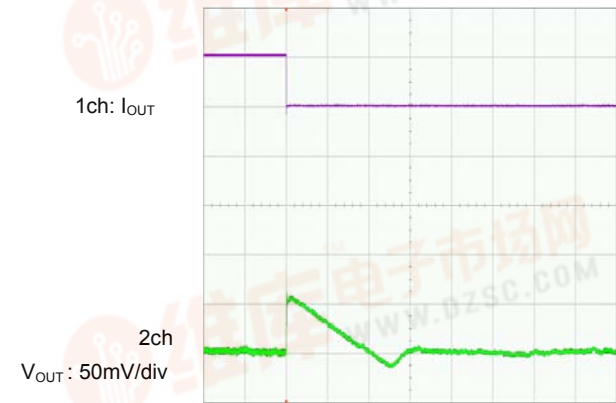

[查询XCM519供应商](#)

TYPICAL PERFORMANCE CHARACTERISTICS (Continued)

(15) Load Transient Response (Continued)

$DC_{OUT} = 1.8V, 3.0MHz$ (PWM/PFM Automatic Switching Control)

$L = 1.5\mu H$ (NR3015), $C_{IN1} = 10\mu F$ (ceramic), $C_{L1} = 10\mu F$ (ceramic), $T_{opr} = 25^\circ C$

$V_{IN1} = 3.6V, EN = V_{IN1}$

$I_{OUT} = 1mA \rightarrow 100mA$

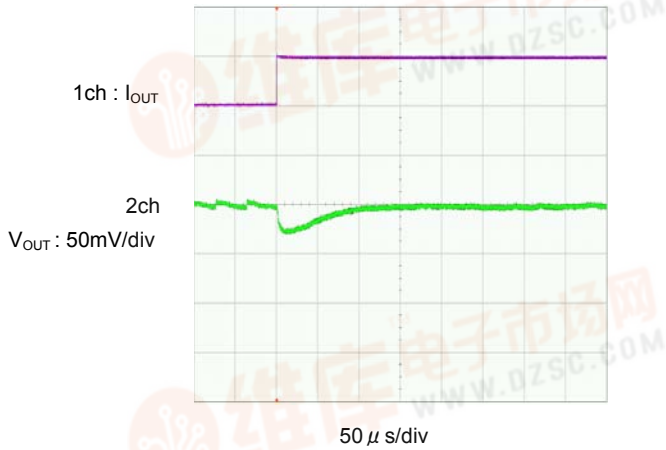

$I_{OUT} = 1mA \rightarrow 300mA$

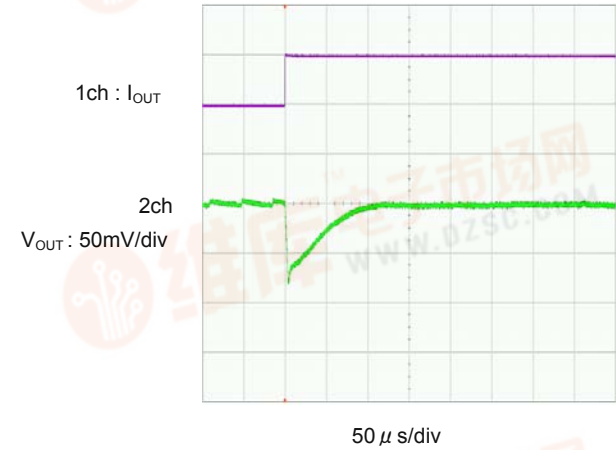

$I_{OUT} = 100mA \rightarrow 1mA$

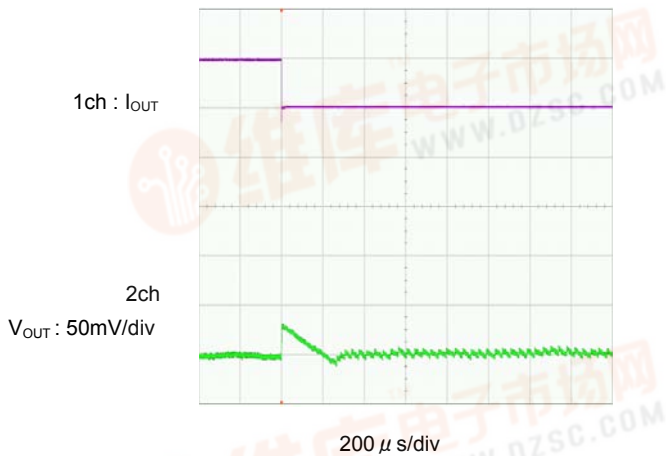

$I_{OUT} = 300mA \rightarrow 1mA$

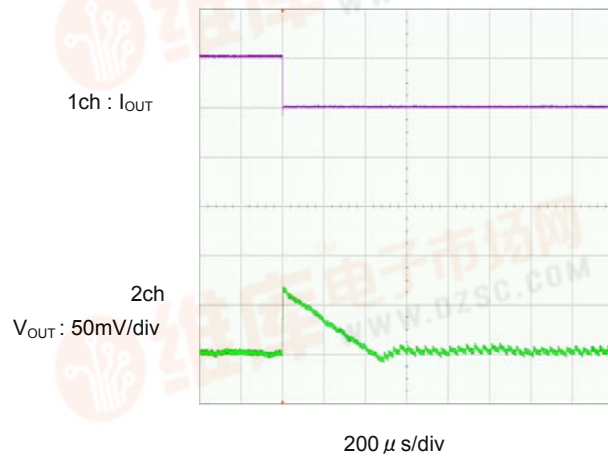

TYPICAL PERFORMANCE CHARACTERISTICS (Continued)

(15) Load Transient Response (Continued)

DCOUT=1.8V,3.0MHz(PWM Control)

L=1.5 μ H(NR3015), C_{IN1}=10 μ F(ceramic), C_{L1}=10 μ F(ceramic), Topr=25°C

V_{IN1}=3.6V, EN1=V_{IN1}

I_{OUT}=1mA \rightarrow 100mA

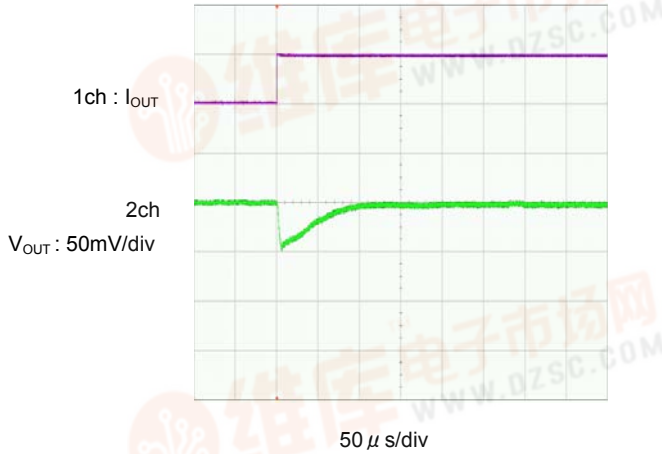

I_{OUT}=1mA \rightarrow 300mA

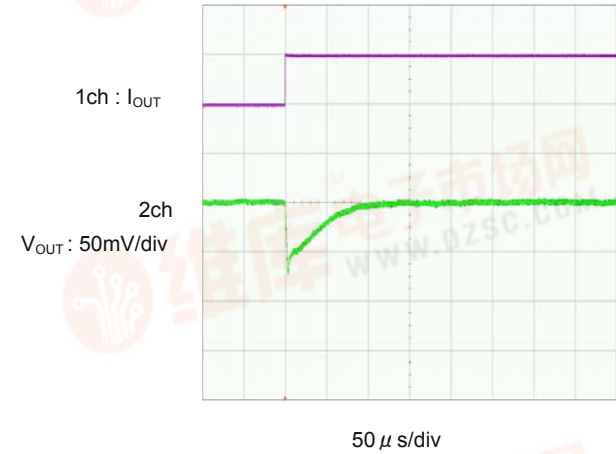

I_{OUT}=100mA \rightarrow 1mA

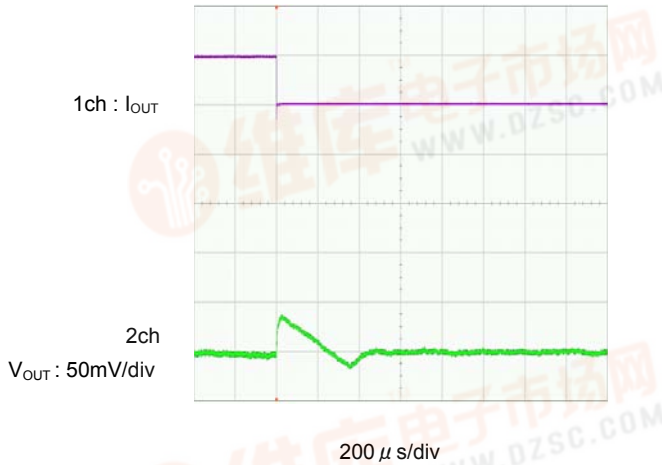

I_{OUT}=300mA \rightarrow 1mA

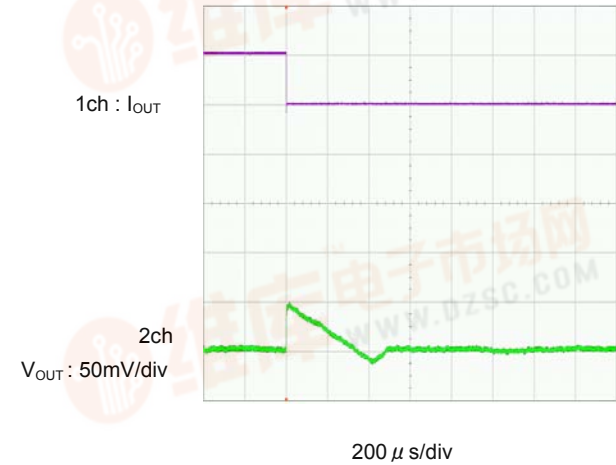

[查询XCM519供应商](#)

TYPICAL PERFORMANCE CHARACTERISTICS (Continued)

2ch:Regulator Block

(1) Output Voltage vs. Output Current

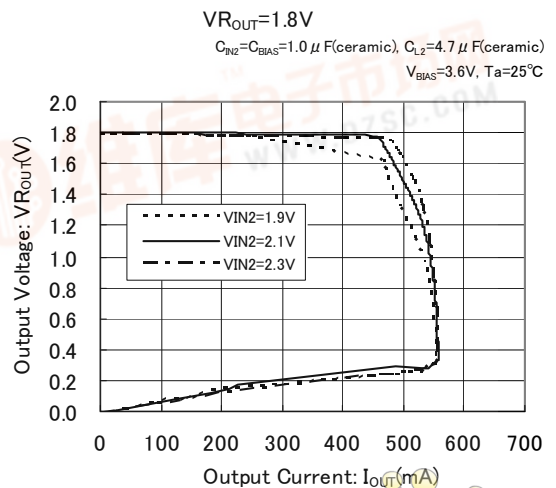
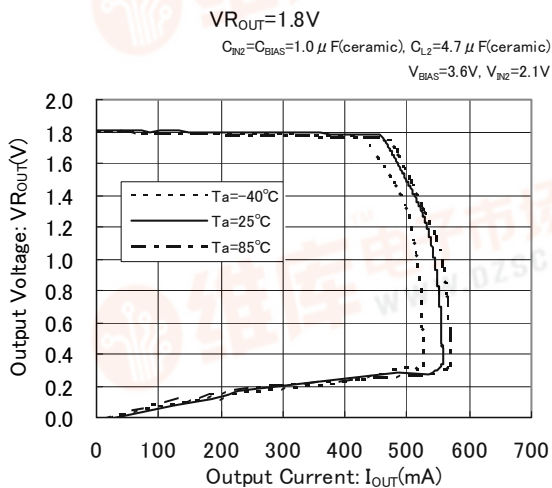
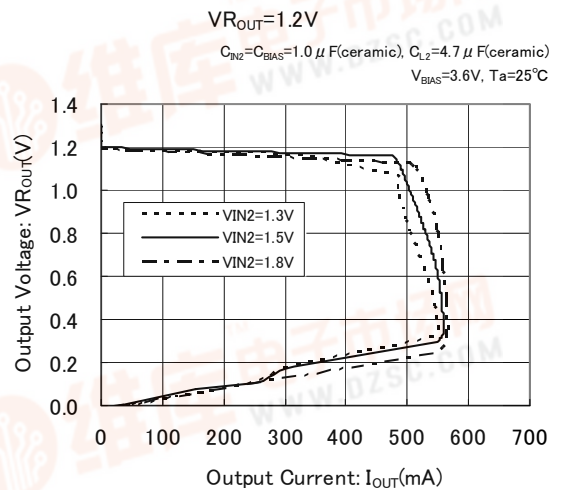
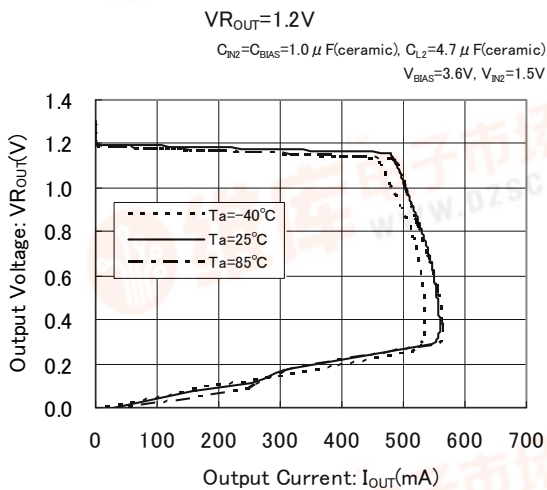
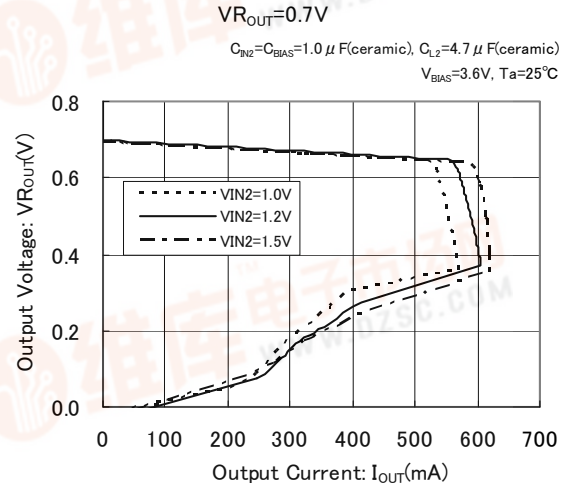
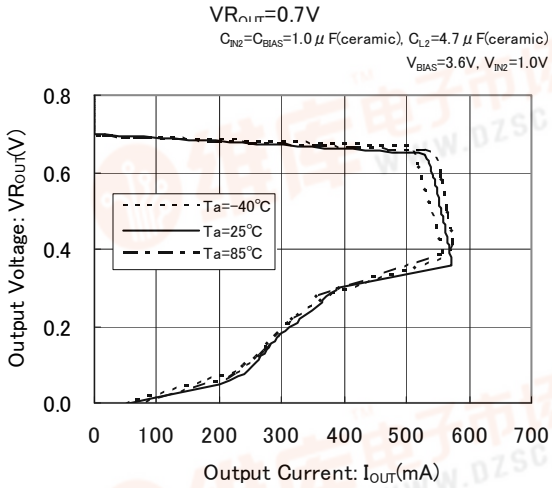

TYPICAL PERFORMANCE CHARACTERISTICS (Continued)

(2) Output Voltage vs. Bias Voltage

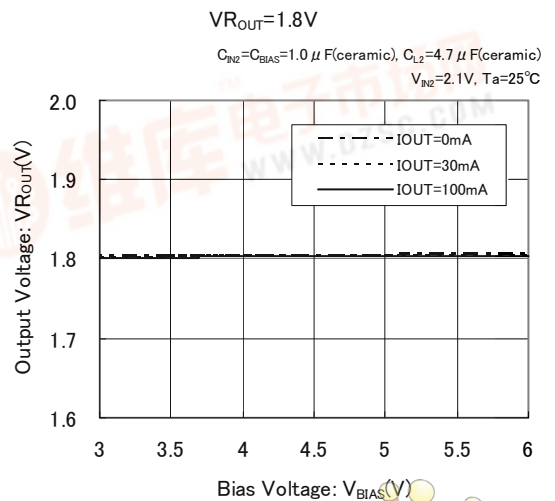
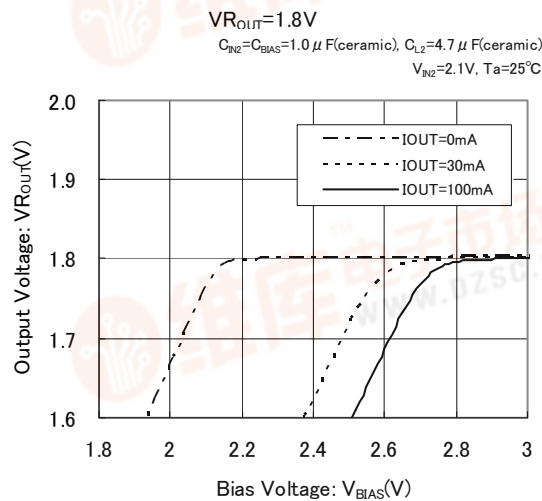
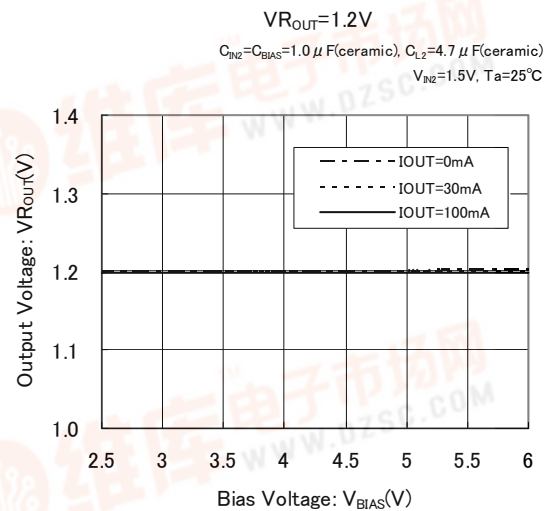
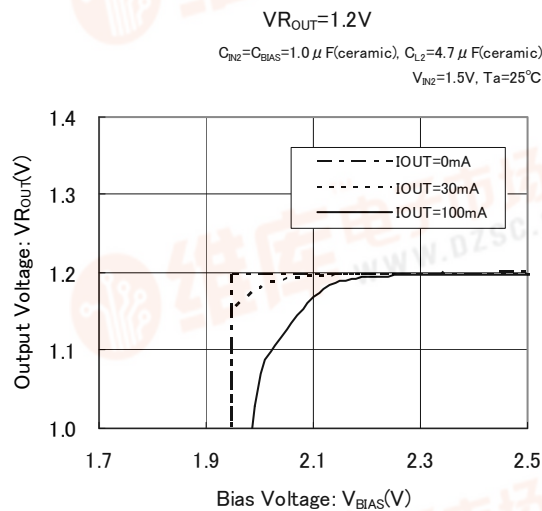
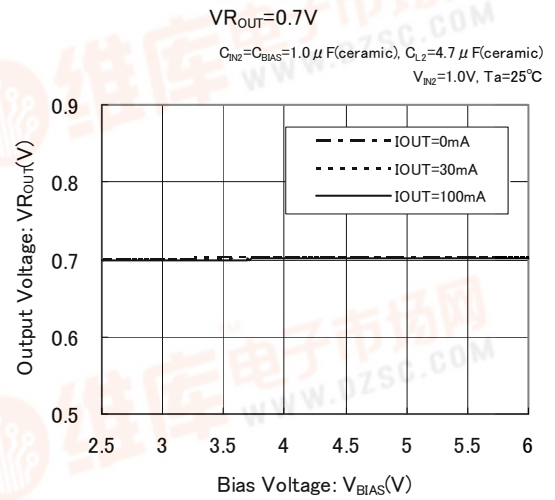
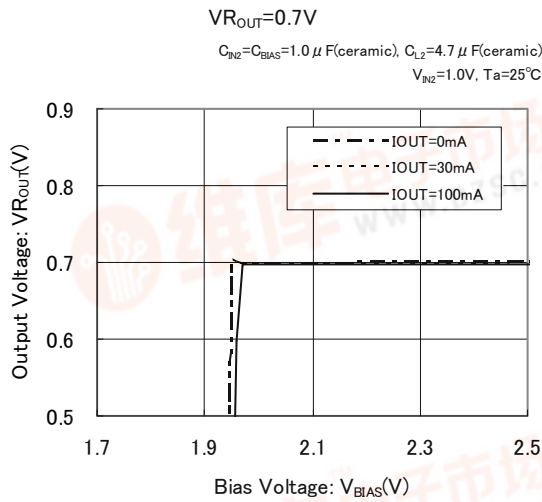

查询XCM519供应商

TYPICAL PERFORMANCE CHARACTERISTICS (Continued)

(3) Output Voltage vs. Input Voltage

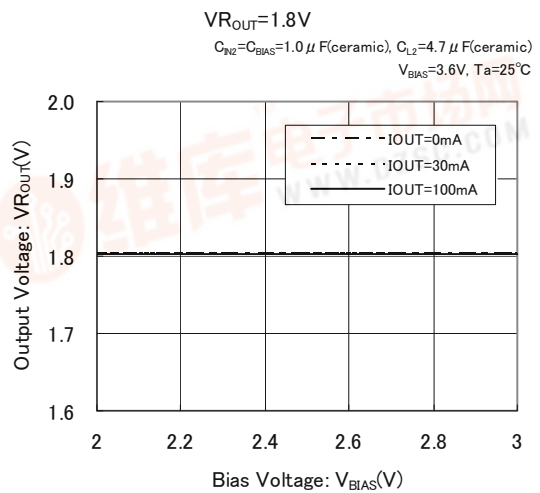
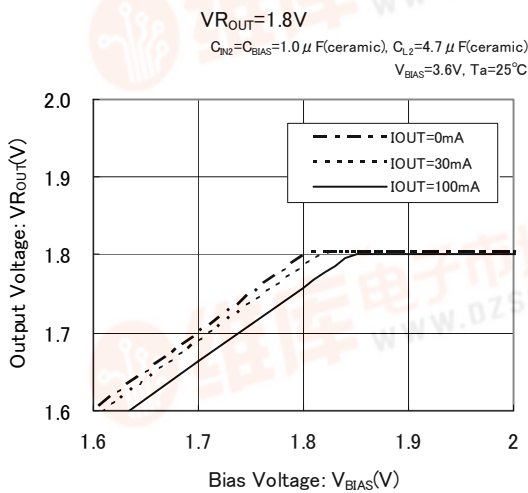
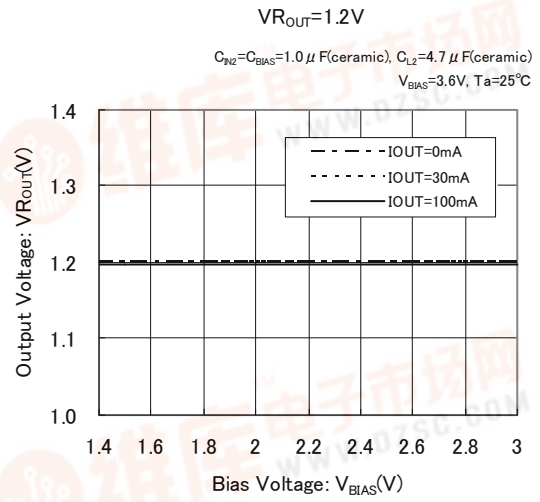
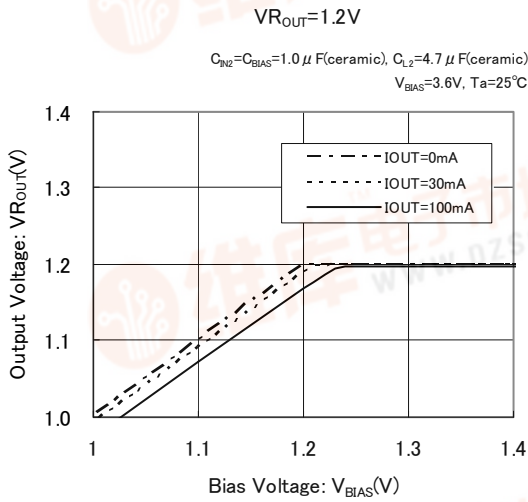
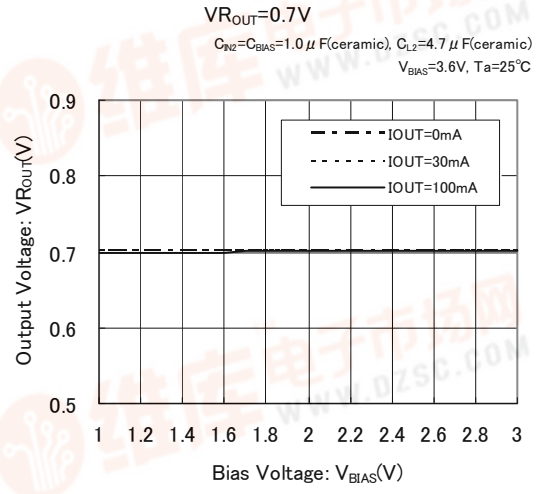
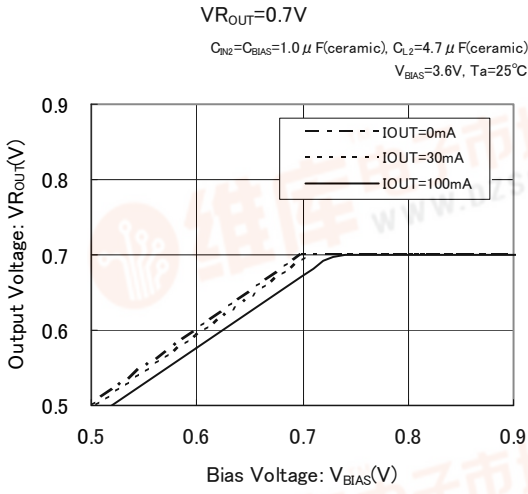

TYPICAL PERFORMANCE CHARACTERISTICS (Continued)

(4) Dropout Voltage vs. Output Current

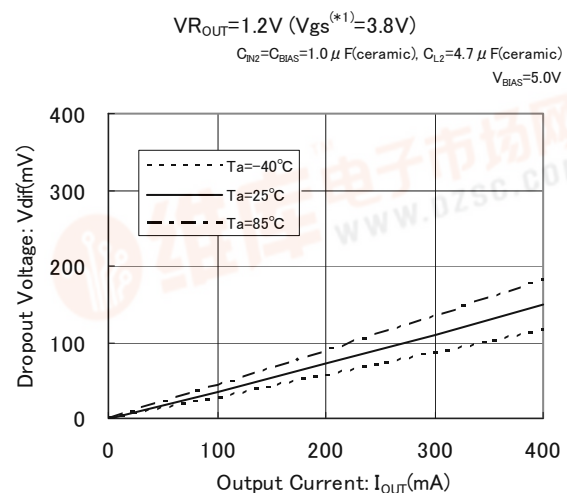
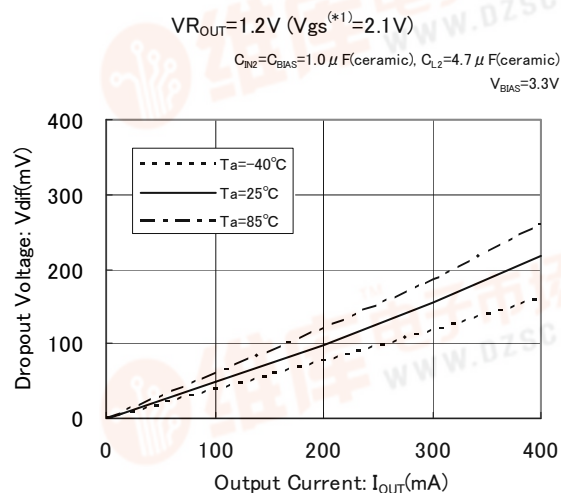
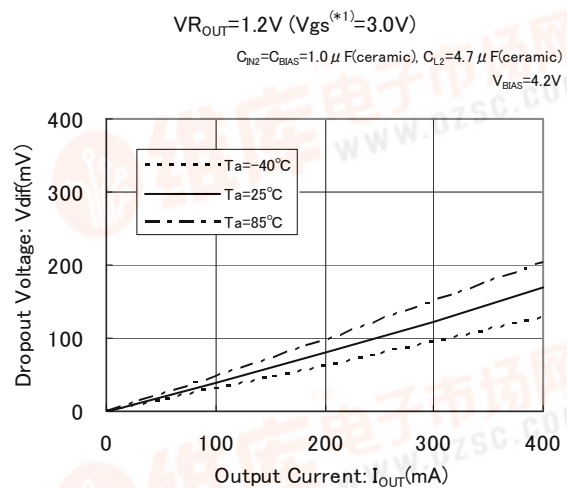
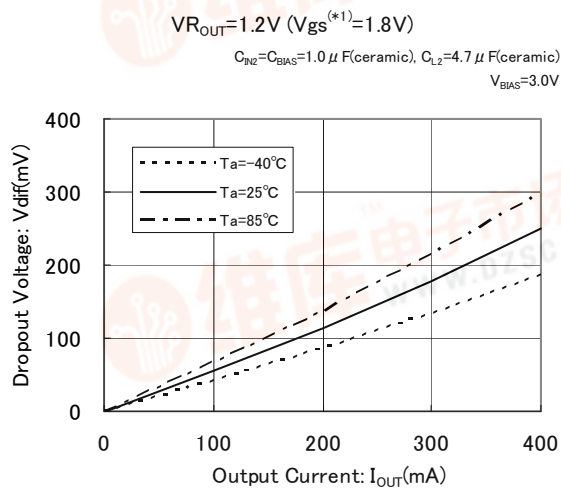
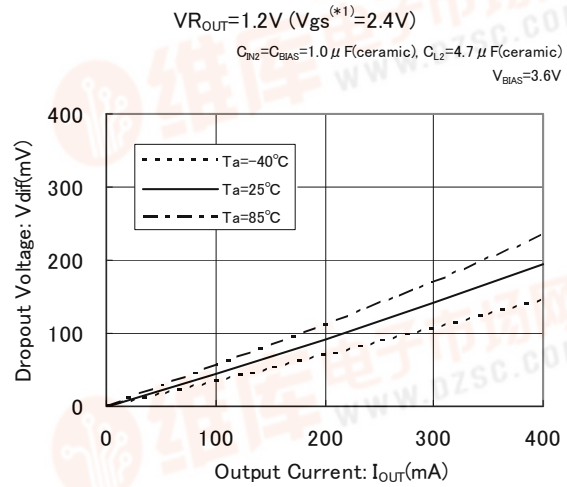
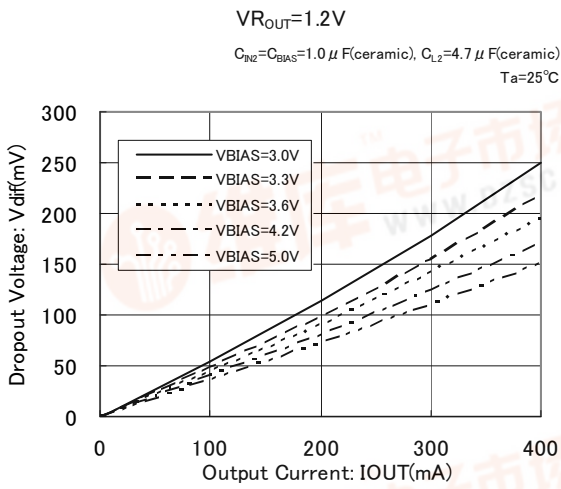

*1): V_{gs} is a Gate-Source voltage of the driver transistor that is defined as the value of $V_{BIAS} - V_{OUT(T)}$.
 A value of the dropout voltage is determined by the value of the V_{gs} .

查询XCM519供应商

TYPICAL PERFORMANCE CHARACTERISTICS (Continued)

(5) Supply Bias Current vs. Bias Voltage

$V_{R_{OUT}}=0.7V$

$C_{IN2}=C_{BIAS}=1.0\mu F(\text{ceramic}), C_{L2}=4.7\mu F(\text{ceramic})$
 $V_{IN2}=1.0V$

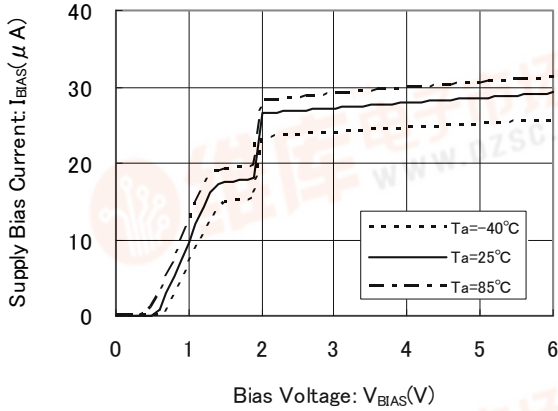

(6) Supply Input Current vs. Input Voltage

$V_{R_{OUT}}=0.7V$

$C_{IN2}=C_{BIAS}=1.0\mu F(\text{ceramic}), C_{L2}=4.7\mu F(\text{ceramic})$
 $V_{BIAS}=3.6V$

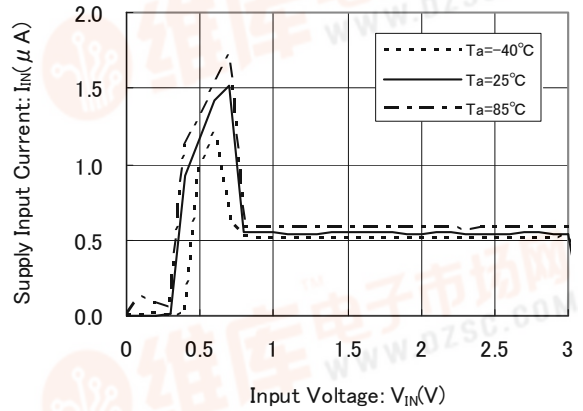

$V_{R_{OUT}}=1.2V$

$C_{IN2}=C_{BIAS}=1.0\mu F(\text{ceramic}), C_{L2}=4.7\mu F(\text{ceramic})$
 $V_{IN2}=1.5V$

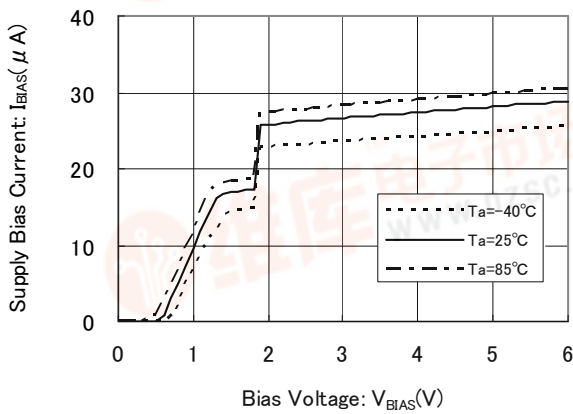

$V_{R_{OUT}}=1.2V$

$C_{IN2}=C_{BIAS}=1.0\mu F(\text{ceramic}), C_{L2}=4.7\mu F(\text{ceramic})$
 $V_{BIAS}=3.6V$

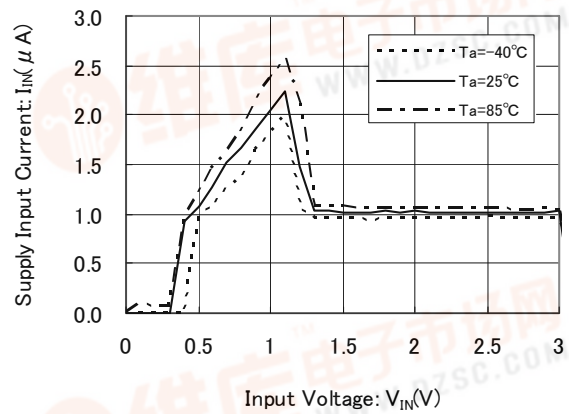

$V_{R_{OUT}}=1.8V$

$C_{IN2}=C_{BIAS}=1.0\mu F(\text{ceramic}), C_{L2}=4.7\mu F(\text{ceramic})$
 $V_{IN2}=2.1V$

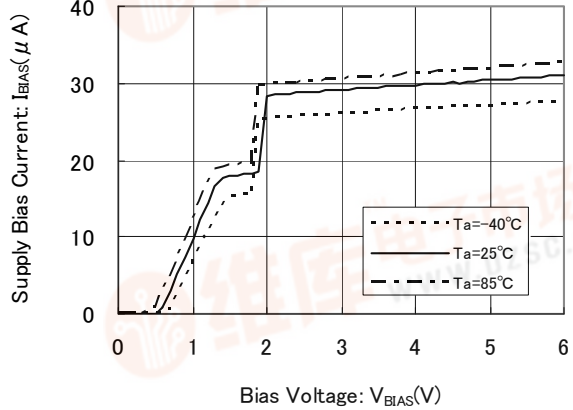

$V_{R_{OUT}}=1.8V$

$C_{IN2}=C_{BIAS}=1.0\mu F(\text{ceramic}), C_{L2}=4.7\mu F(\text{ceramic})$
 $V_{BIAS}=3.6V$

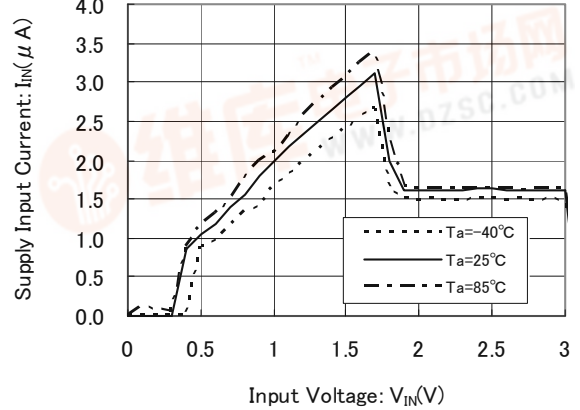

TYPICAL PERFORMANCE CHARACTERISTICS (Continued)

(7) Output Voltage vs. Ambient Temperature

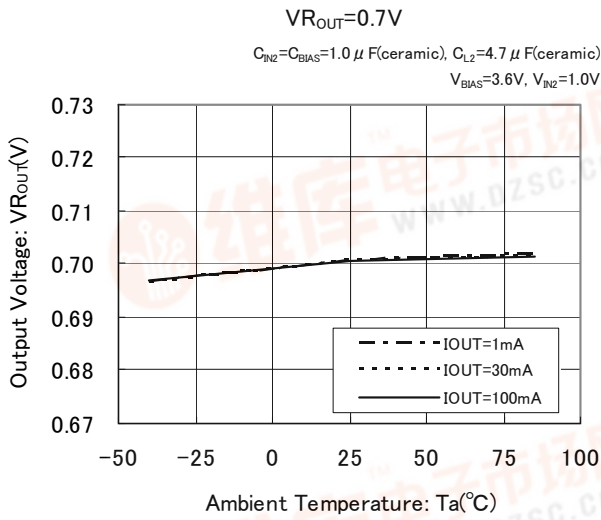

(8) Supply Bias Current vs. Ambient Temperature

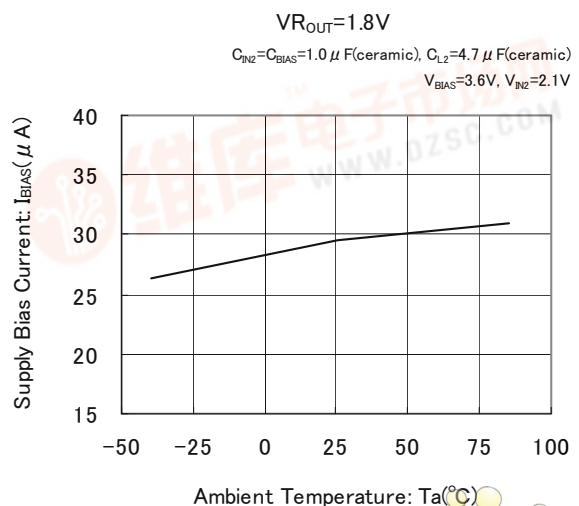
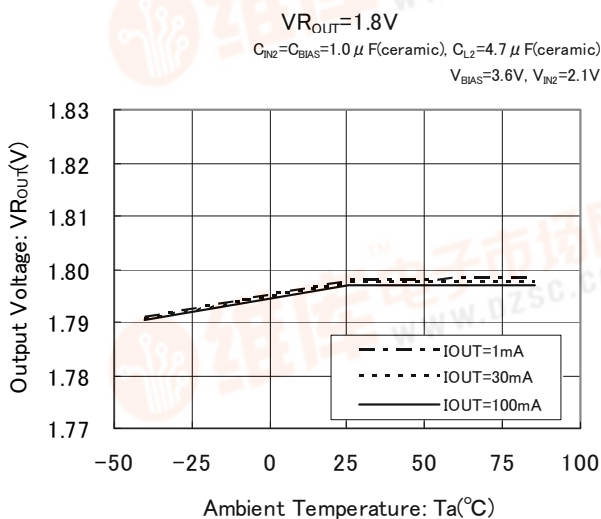
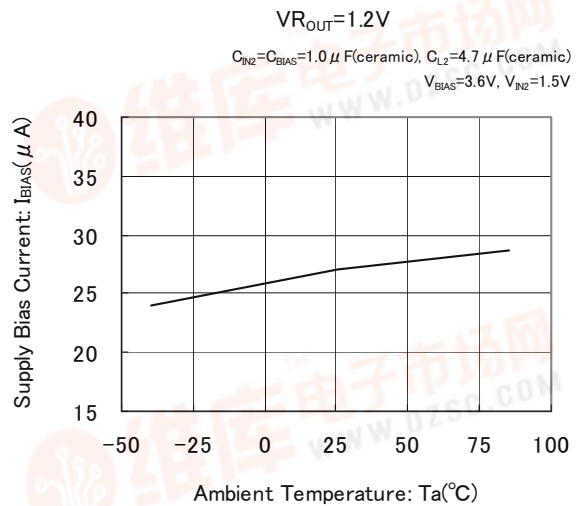
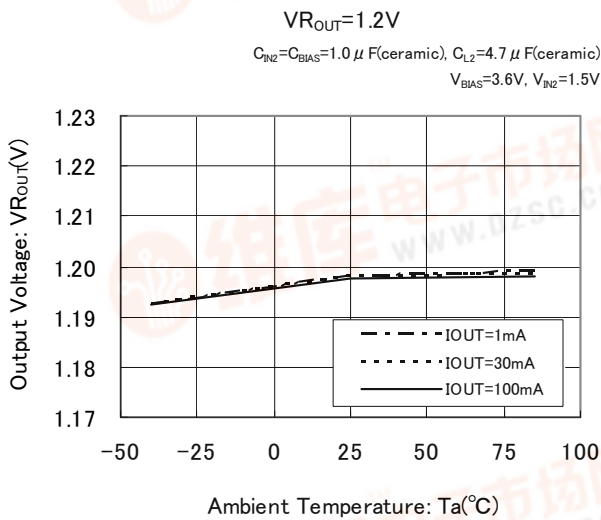
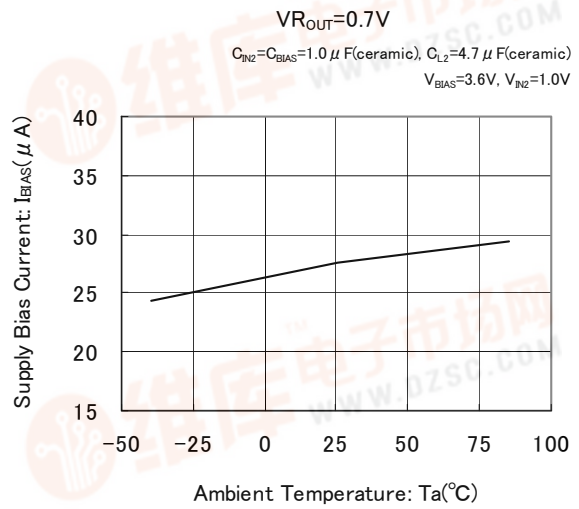

查询XCM519供应商

TYPICAL PERFORMANCE CHARACTERISTICS (Continued)

(9) Supply Input Current vs. Ambient Temperature

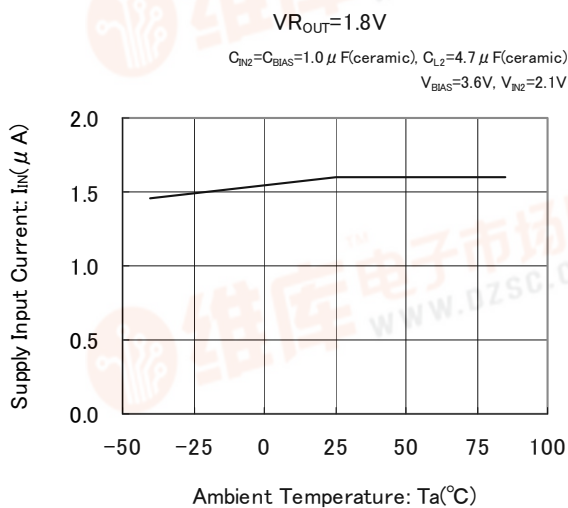
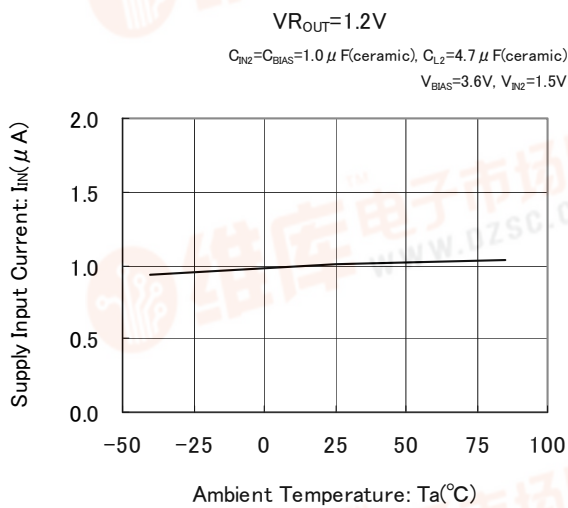
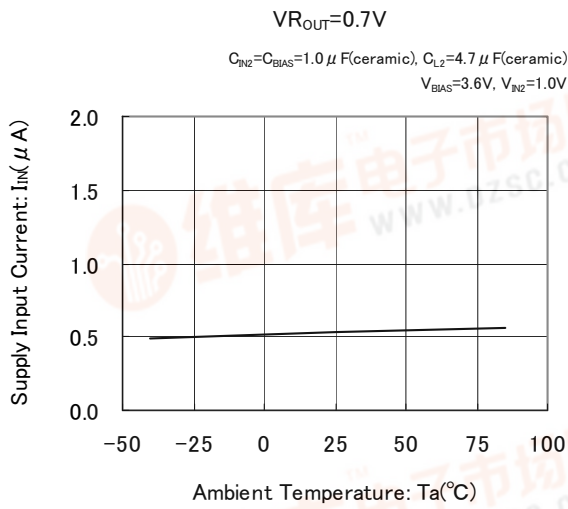

TYPICAL PERFORMANCE CHARACTERISTICS (Continued)

(10) Bias Transient Response

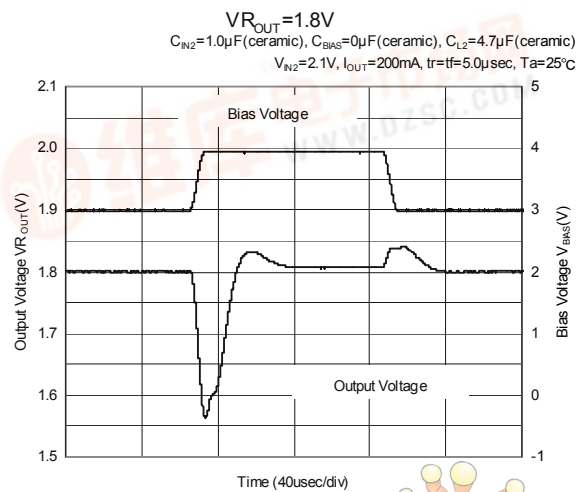
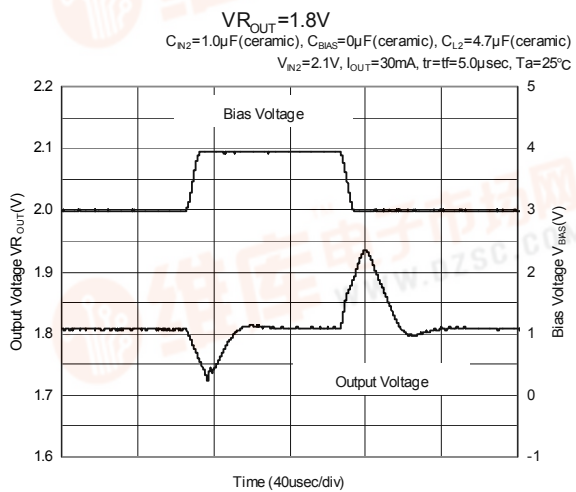
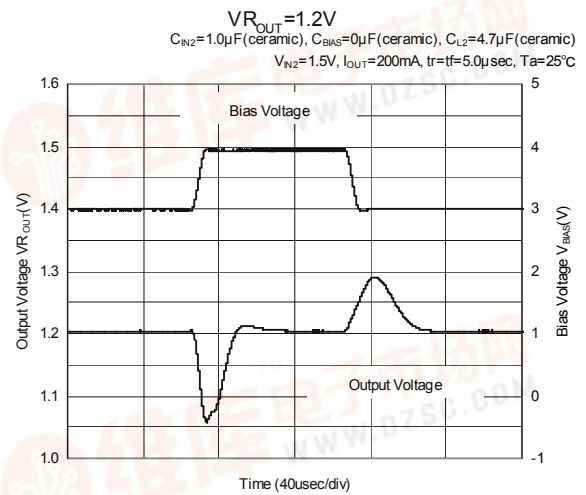
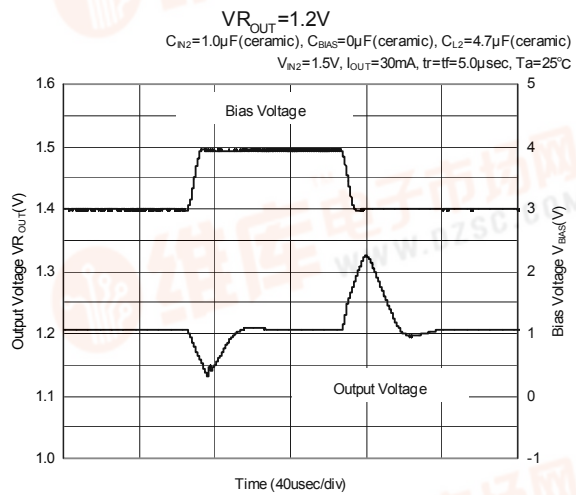
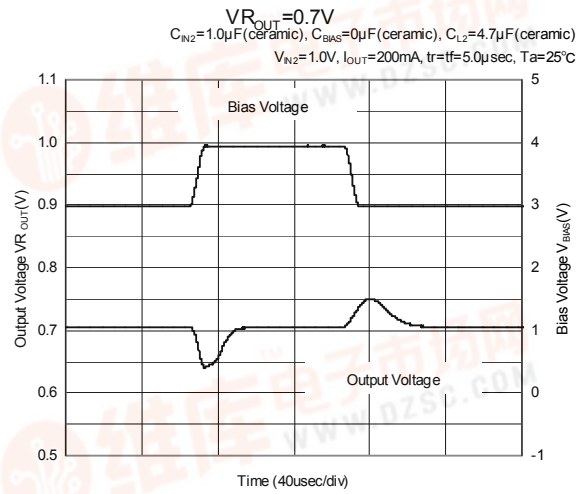
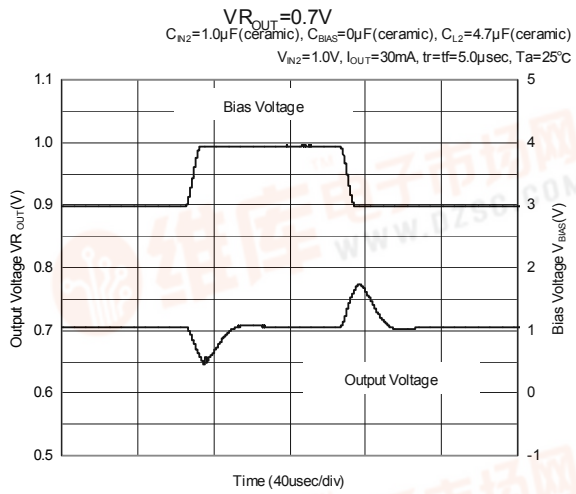

查询XCM519供应商

TYPICAL PERFORMANCE CHARACTERISTICS (Continued)

(11) Input Transient Response

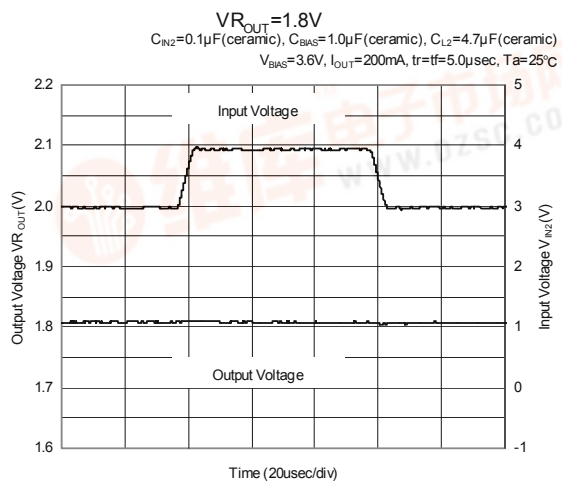
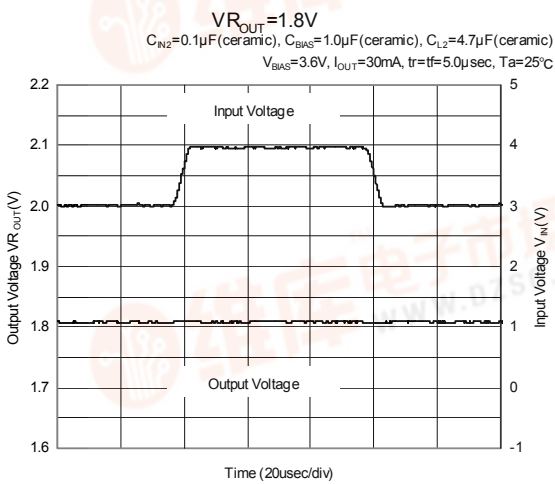
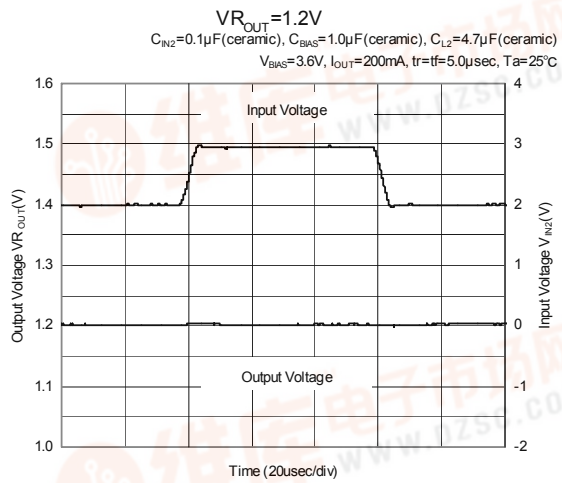
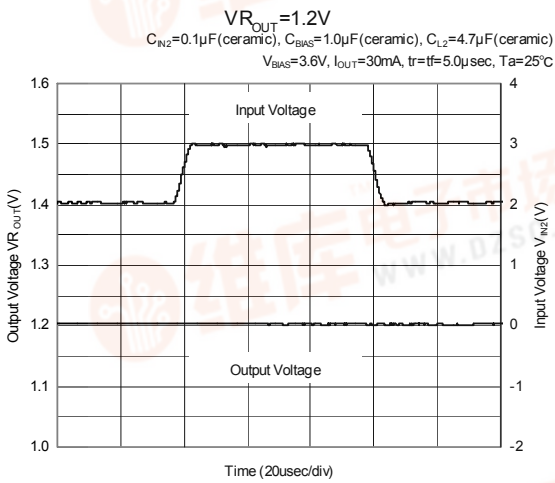
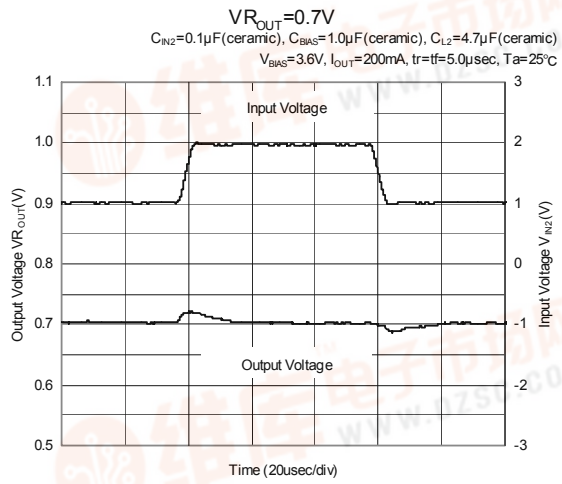
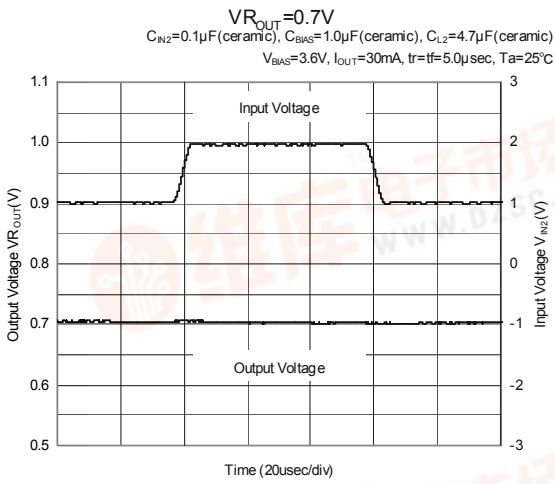

TYPICAL PERFORMANCE CHARACTERISTICS (Continued)

(12) Load Transient Response

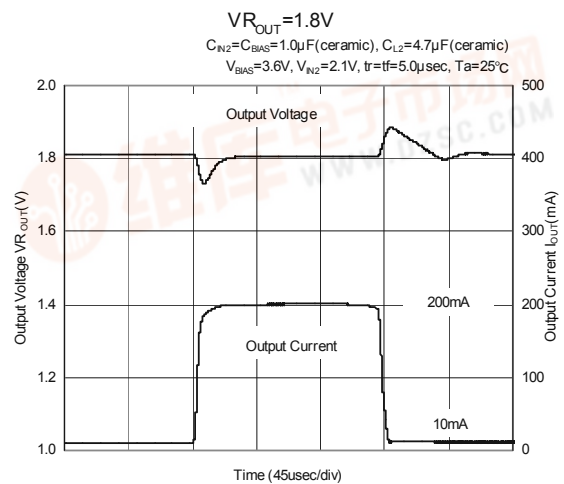
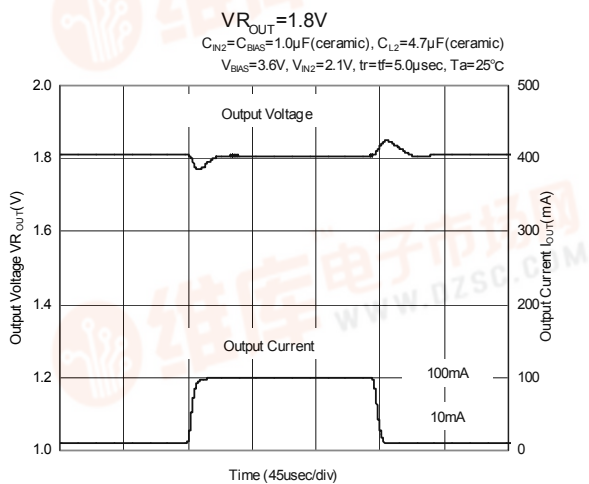
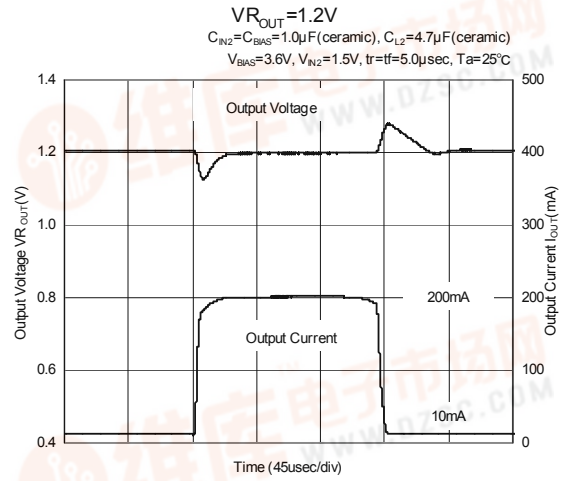
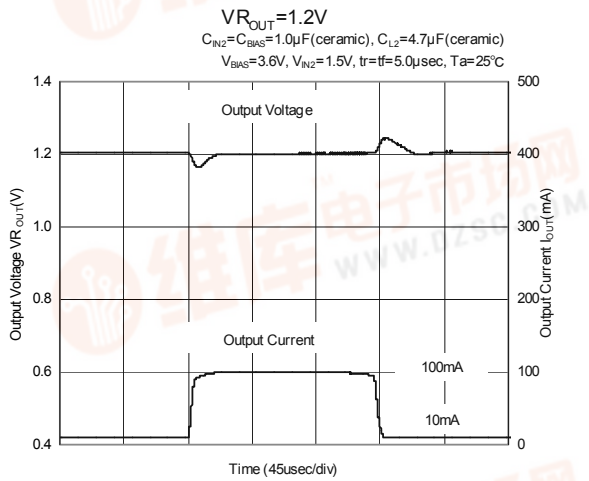
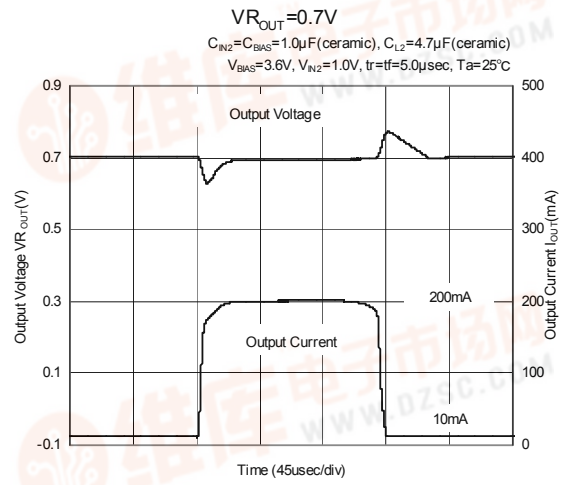
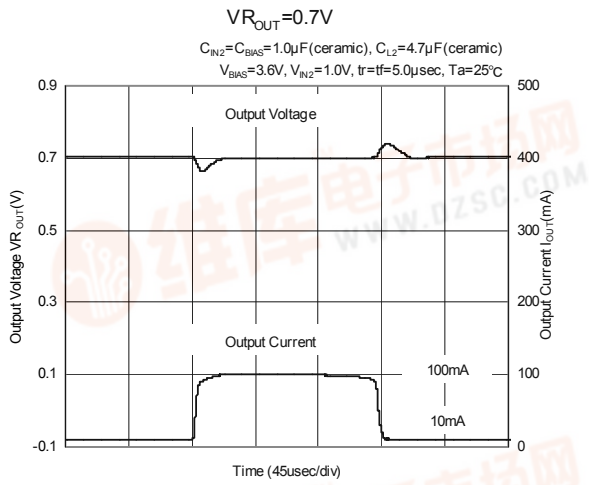

查询XCM519供应商

TYPICAL PERFORMANCE CHARACTERISTICS (Continued)

(13) CE Rising Response Time

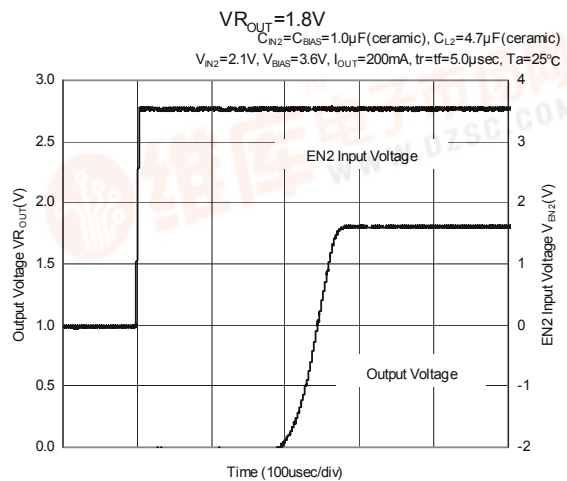
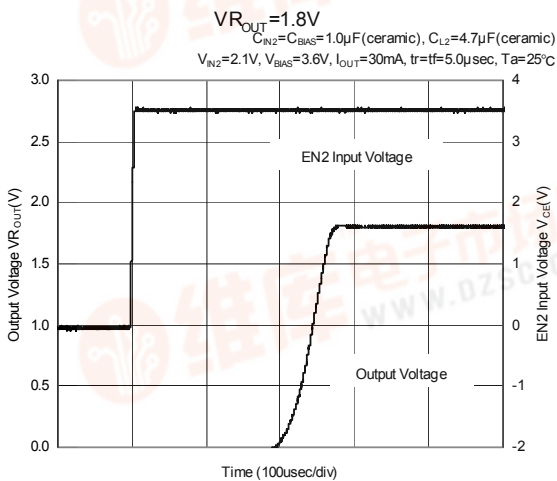
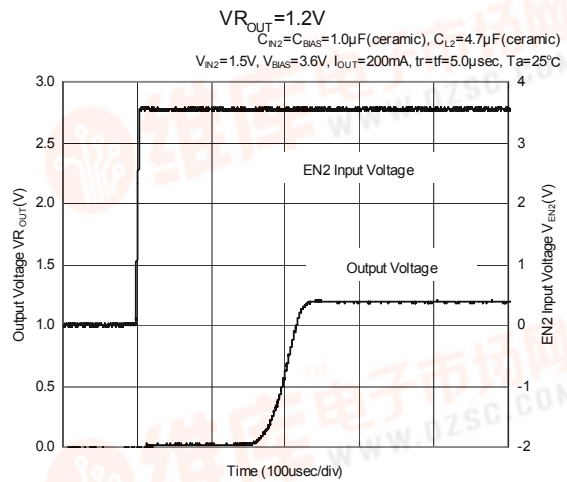
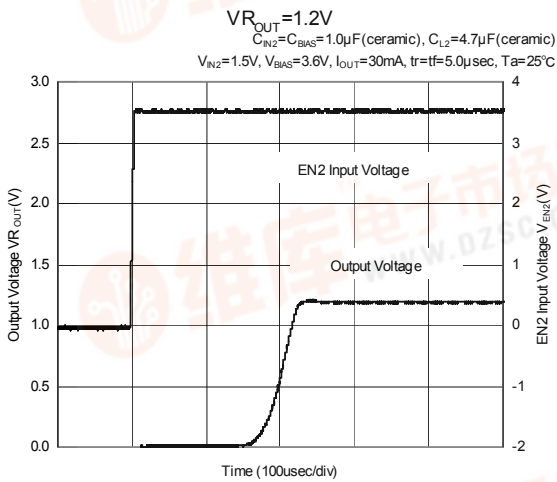
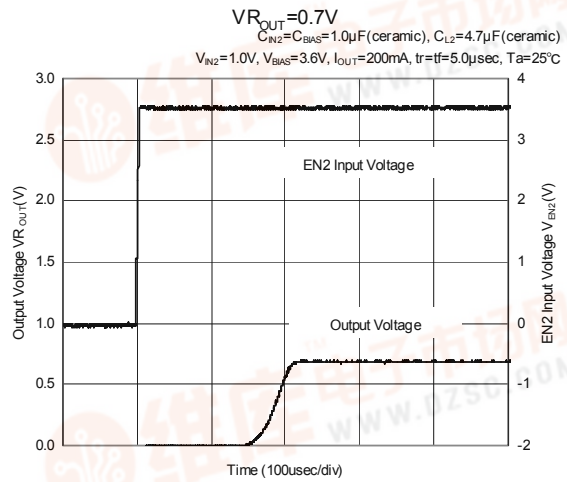
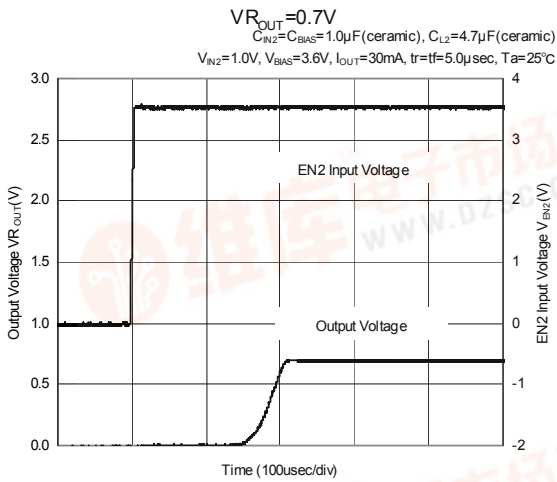

TYPICAL PERFORMANCE CHARACTERISTICS (Continued)

(14) V_{IN} Rising Response Time

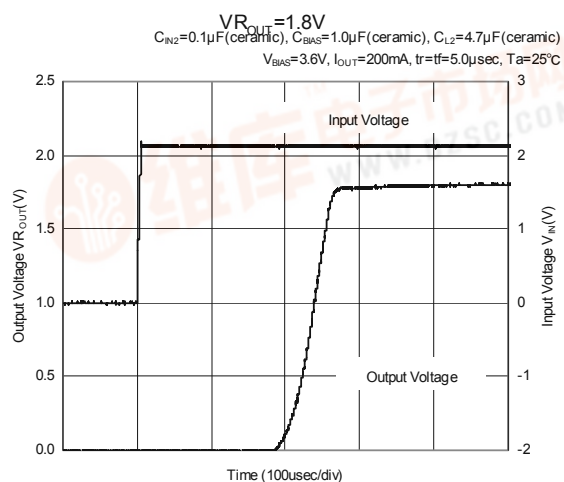
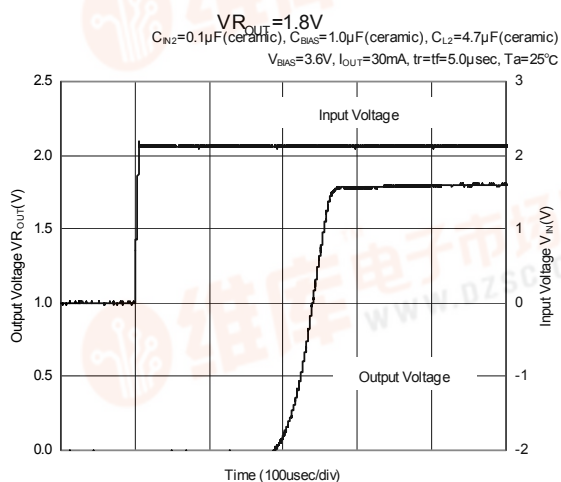
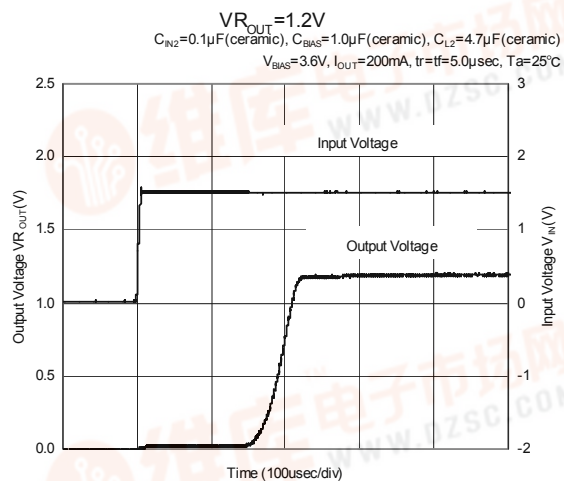
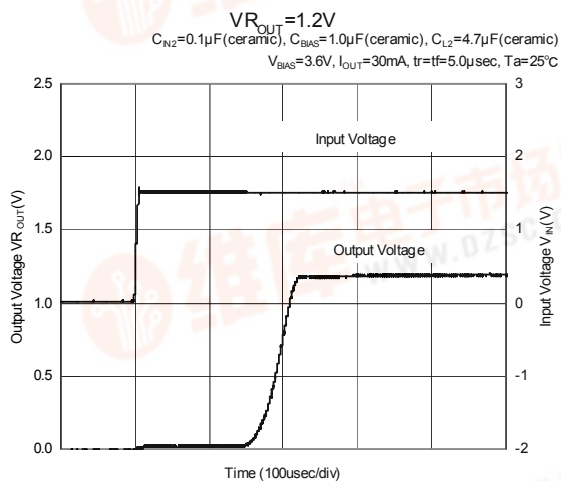
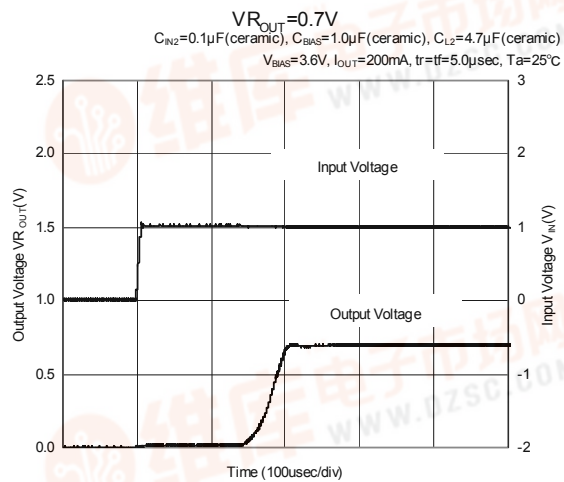
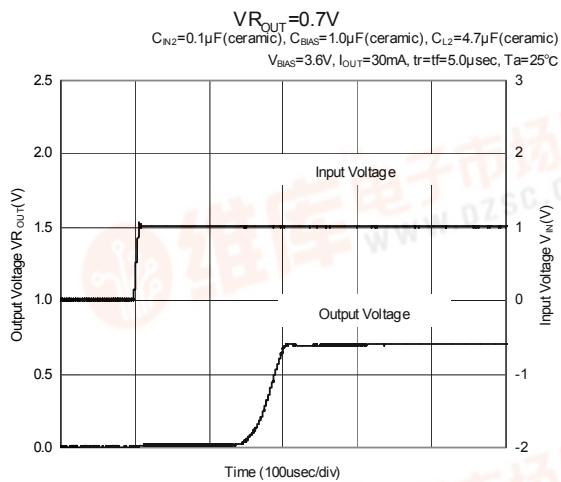

[查询XCM519供应商](#)

TYPICAL PERFORMANCE CHARACTERISTICS (Continued)

(15) Bias Voltage Ripple Rejection Rate

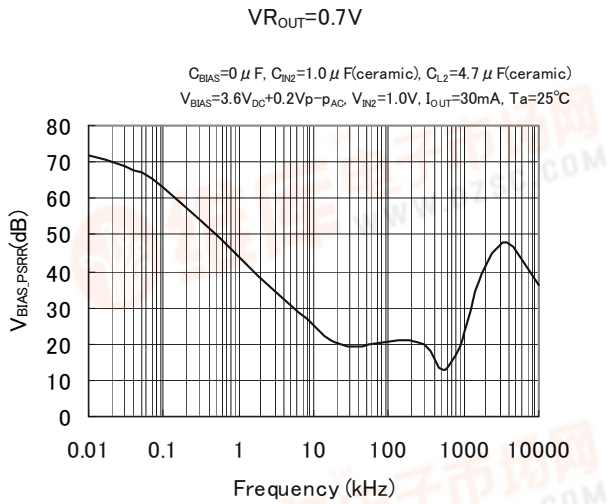

(16) Input Voltage Ripple Rejection Rate

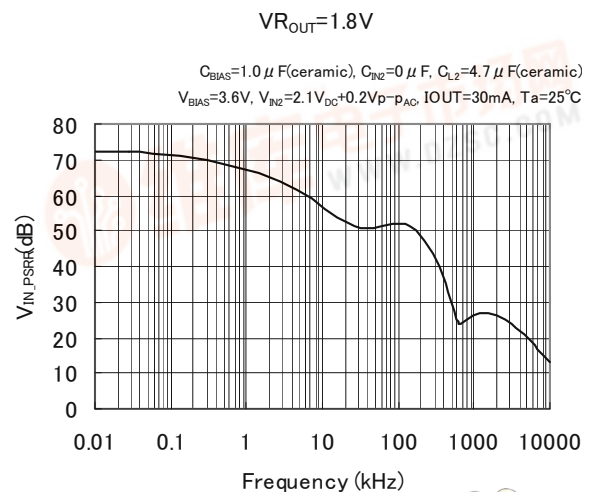
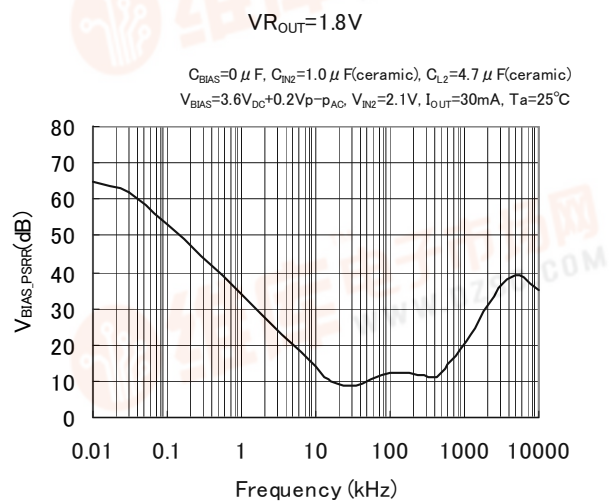
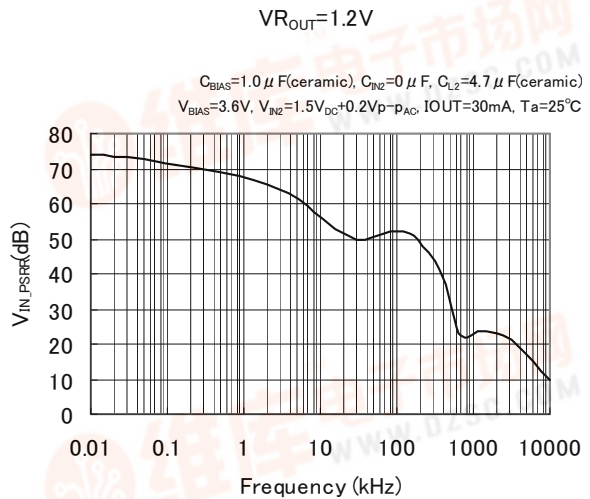
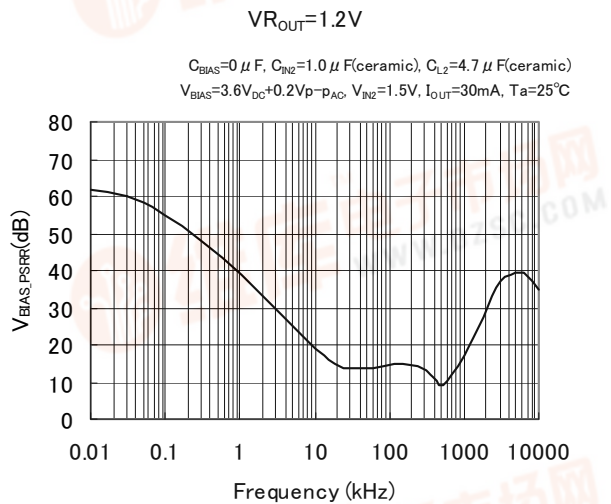
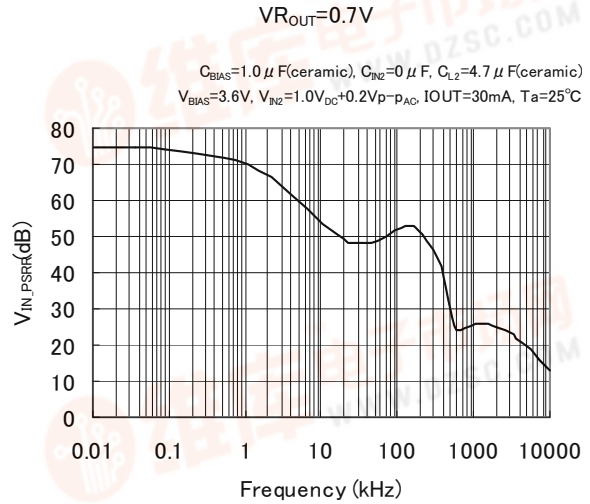

XCM519 Series

[查询XCM519供应商](#)

PACKAGING INFORMATION

● USP-12B01

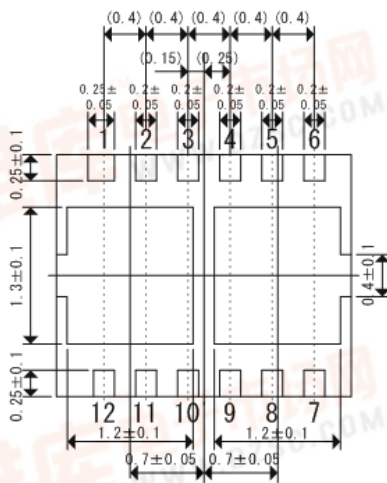
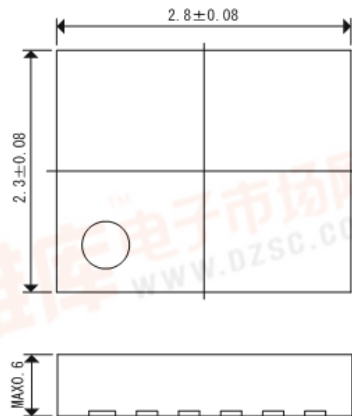

● USP-12B01 Reference Pattern Layout

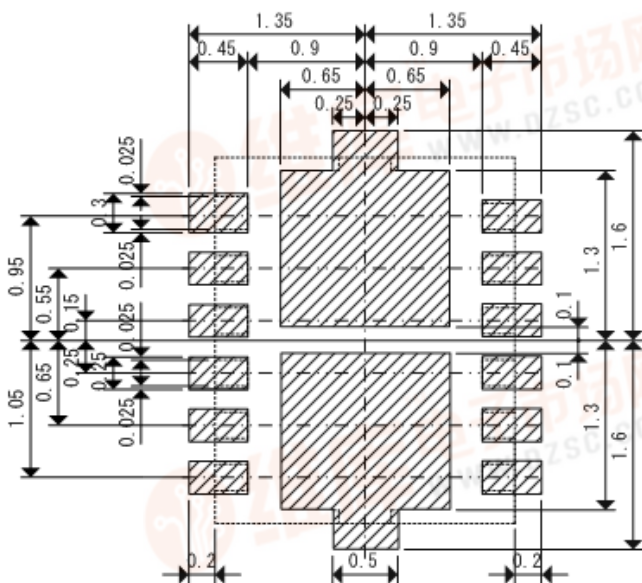

● USP-12B01 Reference Metal Mask Design

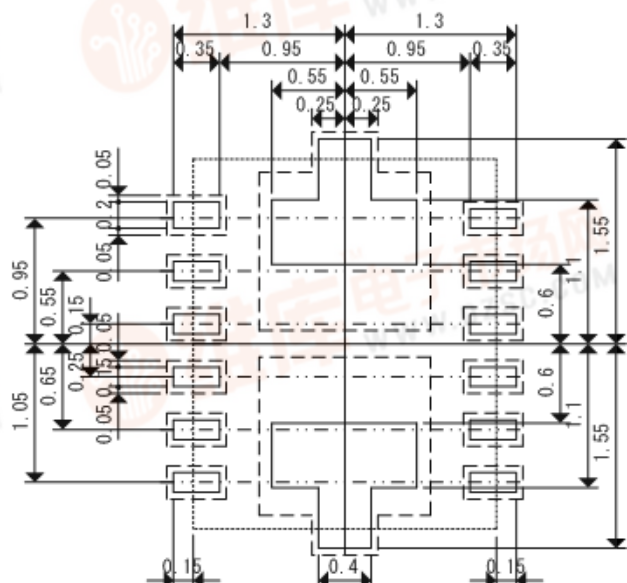

1. The products and product specifications contained herein are subject to change without notice to improve performance characteristics. Consult us, or our representatives before use, to confirm that the information in this datasheet is up to date.
2. We assume no responsibility for any infringement of patents, patent rights, or other rights arising from the use of any information and circuitry in this datasheet.
3. Please ensure suitable shipping controls (including fail-safe designs and aging protection) are in force for equipment employing products listed in this datasheet.
4. The products in this datasheet are not developed, designed, or approved for use with such equipment whose failure of malfunction can be reasonably expected to directly endanger the life of, or cause significant injury to, the user.
(e.g. Atomic energy; aerospace; transport; combustion and associated safety equipment thereof.)
5. Please use the products listed in this datasheet within the specified ranges.
Should you wish to use the products under conditions exceeding the specifications, please consult us or our representatives.
6. We assume no responsibility for damage or loss due to abnormal use.
7. All rights reserved. No part of this datasheet may be copied or reproduced without the prior permission of TOREX SEMICONDUCTOR LTD.

TOREX SEMICONDUCTOR LTD.