

RF Power Field Effect Transistors

N-Channel Enhancement-Mode Lateral MOSFETs

Designed primarily for CW large-signal output and driver applications with frequencies up to 450 MHz. Devices are unmatched and are suitable for use in industrial, medical and scientific applications.

- Typical CW Performance at 220 MHz: $V_{DD} = 50$ Volts, $I_{DQ} = 30$ mA, $P_{out} = 10$ Watts
 Power Gain — 23.9 dB
 Drain Efficiency — 62%
- Capable of Handling 10:1 VSWR, @ 50 Vdc, 220 MHz, 10 Watts CW Output Power

Features

- Characterized with Series Equivalent Large-Signal Impedance Parameters
- Qualified Up to a Maximum of 50 V_{DD} Operation
- Integrated ESD Protection
- 225°C Capable Plastic Package
- RoHS Compliant
- TO-270-2 in Tape and Reel. R1 Suffix = 500 Units per 24 mm, 13 inch Reel.
- TO-272-2 in Tape and Reel. R1 Suffix = 500 Units per 44 mm, 13 inch Reel.

MRF6V2010NR1
MRF6V2010NBR1

10-450 MHz, 10 W, 50 V
LATERAL N-CHANNEL
BROADBAND
RF POWER MOSFETs

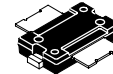

CASE 1265-09, STYLE 1
TO-270-2
PLASTIC
MRF6V2010NR1

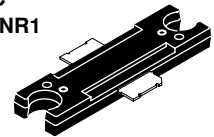

CASE 1337-04, STYLE 1
TO-272-2
PLASTIC
MRF6V2010NBR1

Table 1. Maximum Ratings

Rating	Symbol	Value	Unit
Drain-Source Voltage	V_{DSS}	-0.5, +110	Vdc
Gate-Source Voltage	V_{GS}	-0.5, +10	Vdc
Storage Temperature Range	T_{stg}	- 65 to +150	°C
Case Operating Temperature	T_C	150	°C
Operating Junction Temperature (1,2)	T_J	225	°C

Table 2. Thermal Characteristics

Characteristic	Symbol	Value (2,3)	Unit
Thermal Resistance, Junction to Case Case Temperature 81°C, 10 W CW	$R_{\theta JC}$	3.0	°C/W

1. Continuous use at maximum temperature will affect MTTF.
2. MTTF calculator available at <http://www.freescale.com/rf>. Select Software & Tools/Development Tools/Calculators to access MTTF calculators by product.
3. Refer to AN1955, *Thermal Measurement Methodology of RF Power Amplifiers*. Go to <http://www.freescale.com/rf>. Select Documentation/Application Notes - AN1955.

Table 3. ESD Protection Characteristics

Test Methodology	Class
Human Body Model (per JESD22-A114)	2 (Minimum)
Machine Model (per EIA/JESD22-A115)	A (Minimum)
Charge Device Model (per JESD22-C101)	IV (Minimum)

Table 4. Moisture Sensitivity Level

Test Methodology	Rating	Package Peak Temperature	Unit
Per JESD 22-A113, IPC/JEDEC J-STD-020	3	260	°C

Table 5. Electrical Characteristics ($T_A = 25^\circ\text{C}$ unless otherwise noted)

Characteristic	Symbol	Min	Typ	Max	Unit
----------------	--------	-----	-----	-----	------

Off Characteristics

Gate-Source Leakage Current ($V_{GS} = 5\text{ Vdc}$, $V_{DS} = 0\text{ Vdc}$)	I_{GSS}	—	—	10	μAdc
Drain-Source Breakdown Voltage ($I_D = 5\text{ mA}$, $V_{GS} = 0\text{ Vdc}$)	$V_{(BR)DSS}$	110	—	—	Vdc
Zero Gate Voltage Drain Leakage Current ($V_{DS} = 50\text{ Vdc}$, $V_{GS} = 0\text{ Vdc}$)	I_{DSS}	—	—	50	μAdc
Zero Gate Voltage Drain Leakage Current ($V_{DS} = 100\text{ Vdc}$, $V_{GS} = 0\text{ Vdc}$)	I_{DSS}	—	—	2.5	mA

On Characteristics

Gate Threshold Voltage ($V_{DS} = 10\text{ Vdc}$, $I_D = 28\ \mu\text{Adc}$)	$V_{GS(th)}$	1	1.68	3	Vdc
Gate Quiescent Voltage ($V_{DD} = 50\text{ Vdc}$, $I_D = 30\text{ mAdc}$, Measured in Functional Test)	$V_{GS(Q)}$	1.5	2.68	3.5	Vdc
Drain-Source On-Voltage ($V_{GS} = 10\text{ Vdc}$, $I_D = 70\text{ mAdc}$)	$V_{DS(on)}$	—	0.26	—	Vdc

Dynamic Characteristics

Reverse Transfer Capacitance ($V_{DS} = 50\text{ Vdc} \pm 30\text{ mV(rms)ac}$ @ 1 MHz, $V_{GS} = 0\text{ Vdc}$)	C_{rss}	—	0.13	—	pF
Output Capacitance ($V_{DS} = 50\text{ Vdc} \pm 30\text{ mV(rms)ac}$ @ 1 MHz, $V_{GS} = 0\text{ Vdc}$)	C_{oss}	—	7.3	—	pF
Input Capacitance ($V_{DS} = 50\text{ Vdc}$, $V_{GS} = 0\text{ Vdc} \pm 30\text{ mV(rms)ac}$ @ 1 MHz)	C_{iss}	—	16.3	—	pF

Functional Tests (In Freescale Test Fixture, 50 ohm system) $V_{DD} = 50\text{ Vdc}$, $I_{DQ} = 30\text{ mA}$, $P_{out} = 10\text{ W}$, $f = 220\text{ MHz}$, CW

Power Gain	G_{ps}	22.5	23.9	25.5	dB
Drain Efficiency	η_D	58	62	—	%
Input Return Loss	IRL	—	-14	-9	dB



ATTENTION: The MRF6V2010N and MRF6V2010NB are high power devices and special considerations must be followed in board design and mounting. Incorrect mounting can lead to internal temperatures which exceed the maximum allowable operating junction temperature. Refer to Freescale Application Note AN3263 (for bolt down mounting) or AN1907 (for solder reflow mounting) **PRIOR TO STARTING SYSTEM DESIGN** to ensure proper mounting of these devices.

查询"MRF6V2010N"供应商

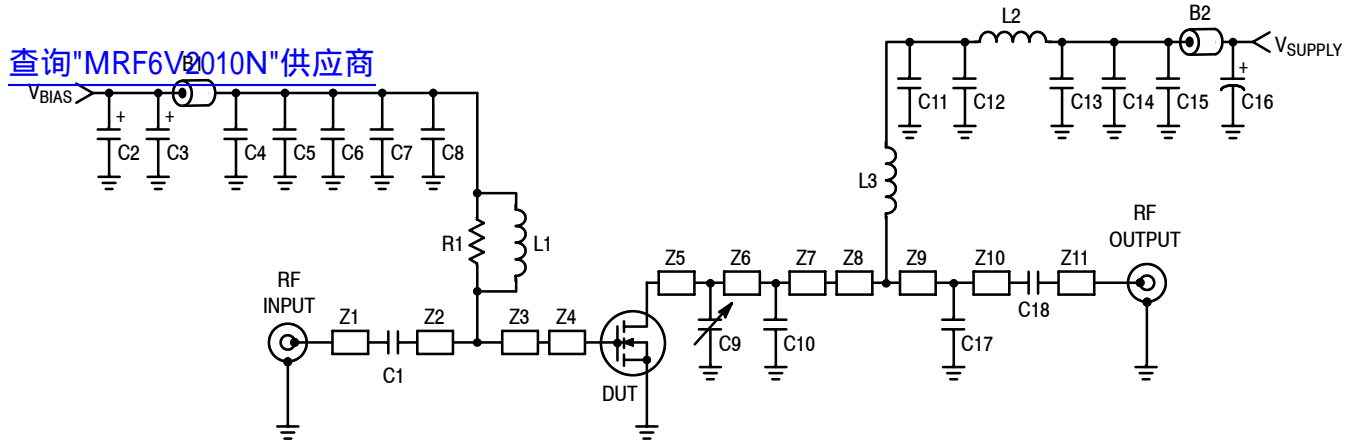

Z1	0.235" x 0.082" Microstrip	Z7	0.062" x 0.270" Microstrip
Z2	1.190" x 0.082" Microstrip	Z8	0.198" x 0.082" Microstrip
Z3	0.619" x 0.082" Microstrip	Z9	5.600" x 0.082" Microstrip
Z4	0.190" x 0.270" Microstrip	Z10	0.442" x 0.082" Microstrip
Z5	0.293" x 0.270" Microstrip	Z11	0.341" x 0.082" Microstrip
Z6	0.120" x 0.270" Microstrip	PCB	Arlon CuClad 250GX-0300-55-22, 0.030", $\epsilon_r = 2.55$

Figure 1. MRF6V2010NR1(NBR1) Test Circuit Schematic

Table 6. MRF6V2010NR1(NBR1) Test Circuit Component Designations and Values

Part	Description	Part Number	Manufacturer
B1, B2	95 Ω , 100 MHz Long Ferrite Beads	2743021447	Fair-Rite
C1, C8, C11, C18	1000 pF Chip Capacitors	ATC100B102JT50XT	ATC
C2	10 μ F, 35 V Tantalum Capacitor	T491D106K035AT	Kemet
C3	22 μ F, 35 V Tantalum Capacitor	T491X226K035AT	Kemet
C4, C13	39 K pF Chip Capacitors	ATC200B393KT50XT	ATC
C5, C14	22 K pF Chip Capacitors	ATC200B223KT50XT	ATC
C6, C15	0.1 μ F Chip Capacitors	CDR33BX104AKYS	Kemet
C7, C12	2.2 μ F, 50 V Chip Capacitors	C1825C225J5RAC	Kemet
C9	0.6-4.5 pF Variable Capacitor, Gigatrim	27271SL	Johanson
C10	12 pF Chip Capacitor	ATC100B120JT500XT	ATC
C16	470 μ F, 63 V Electrolytic Capacitor	ESMG630ELL471MK205	United Chemi-Con
C17	27 pF Chip Capacitor	ATC100B270JT500XT	ATC
L1	17.5 nH Inductor	B06T	CoilCraft
L2, L3	82 nH Inductors	1812SMS-82NJ	CoilCraft
R1	120 Ω , 1/4 W Chip Resistor	CRCW1206120RFKEA	Vishay

查询"MRF6V2010N"供应商

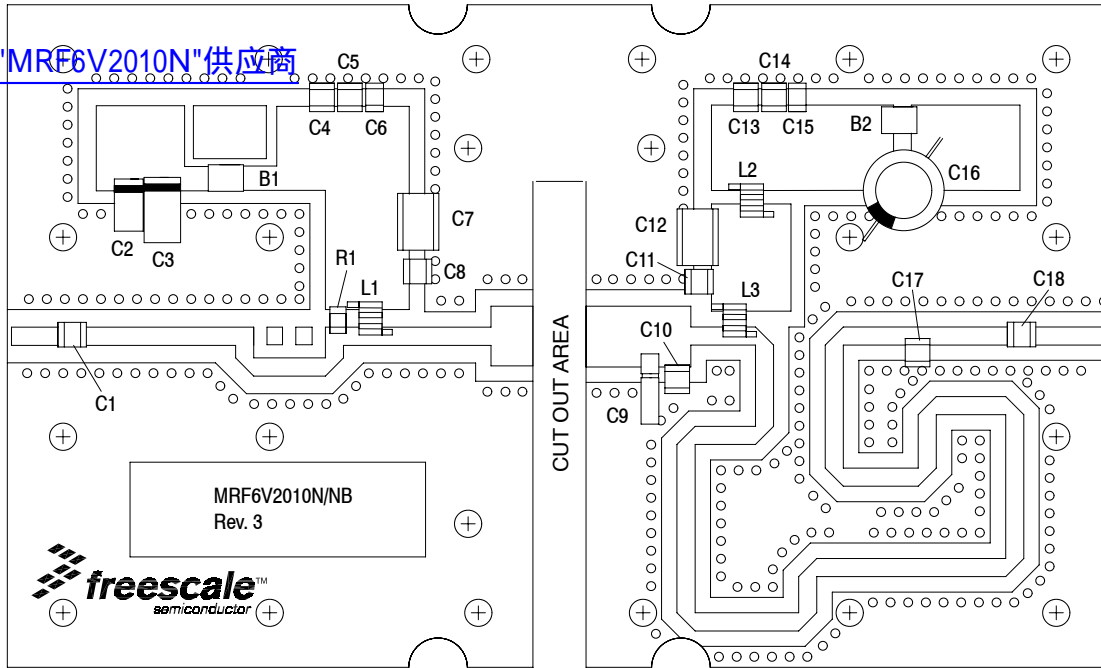

Figure 2. MRF6V2010NR1(NBR1) Test Circuit Component Layout

TYPICAL CHARACTERISTICS

查询"MRF6V2010N"供应商

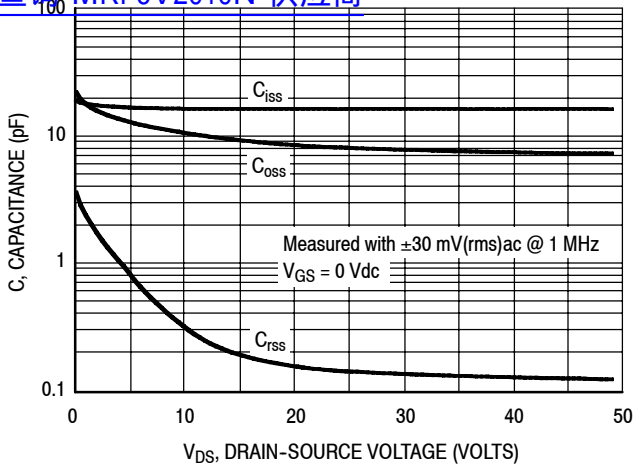

Figure 3. Capacitance versus Drain-Source Voltage

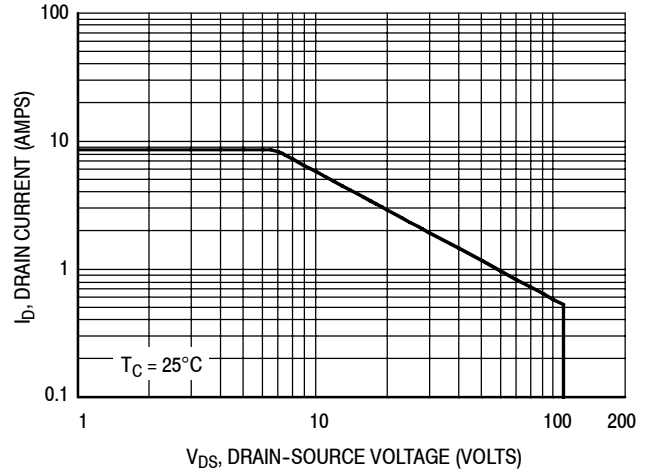

Figure 4. DC Safe Operating Area

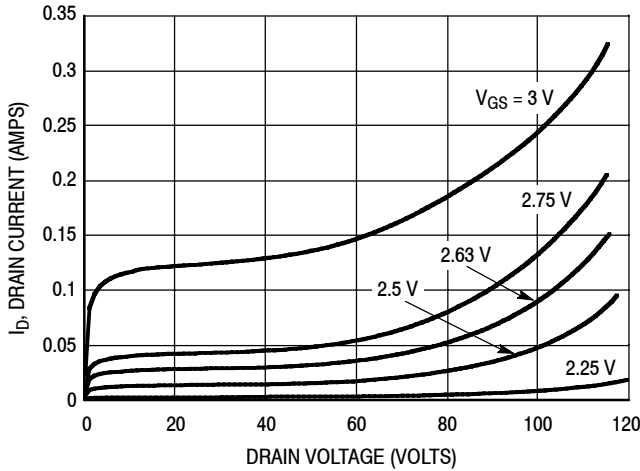

Figure 5. DC Drain Current versus Drain Voltage

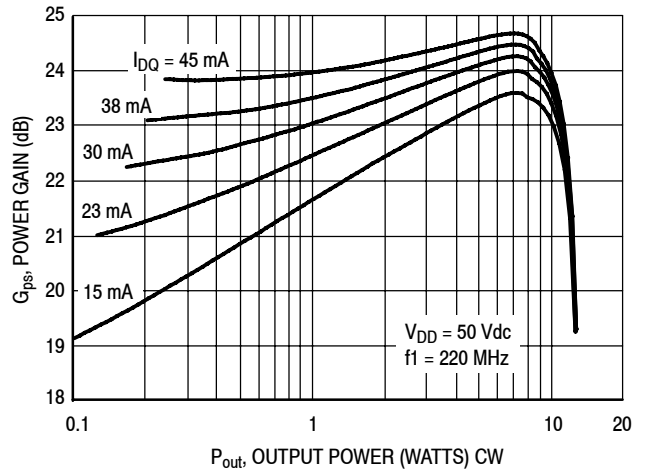

Figure 6. CW Power Gain versus Output Power

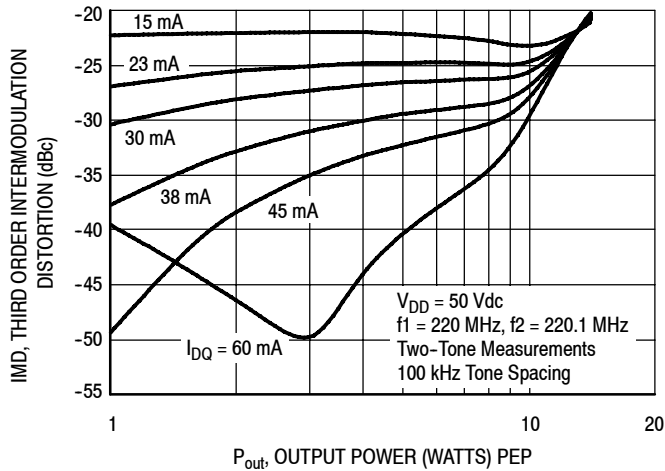

Figure 7. Third Order Intermodulation Distortion versus Output Power

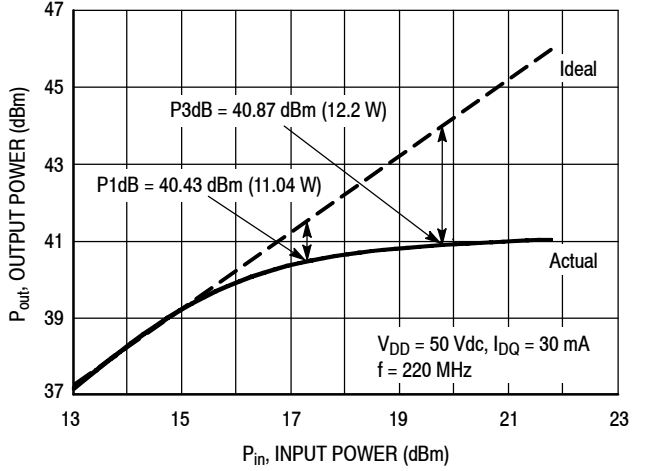

Figure 8. CW Output Power versus Input Power

TYPICAL CHARACTERISTICS

查询"MRF6V2010N"供应商

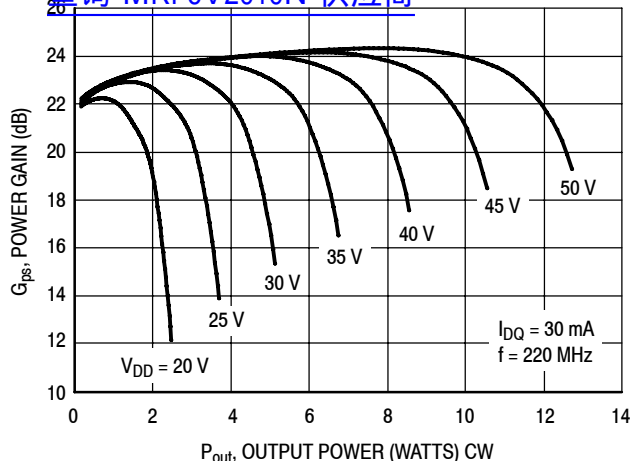

Figure 9. Power Gain versus Output Power

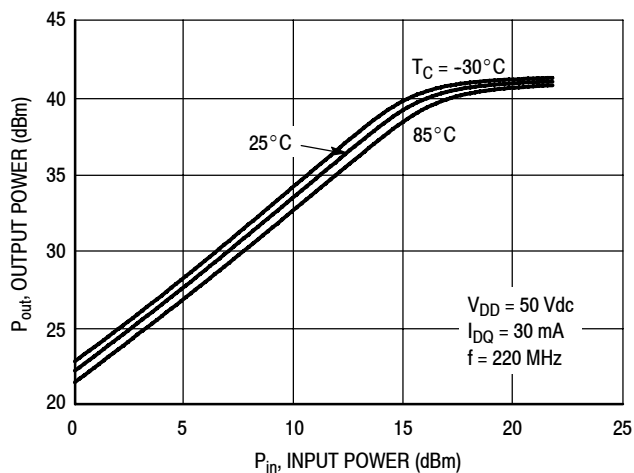

Figure 10. Power Output versus Power Input

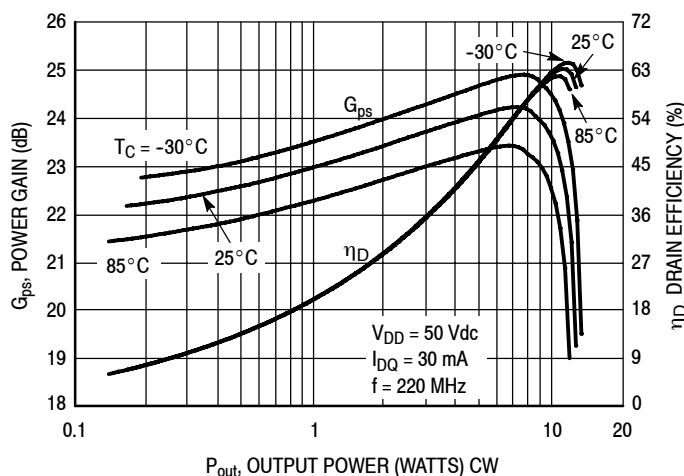

Figure 11. Power Gain and Drain Efficiency versus CW Output Power

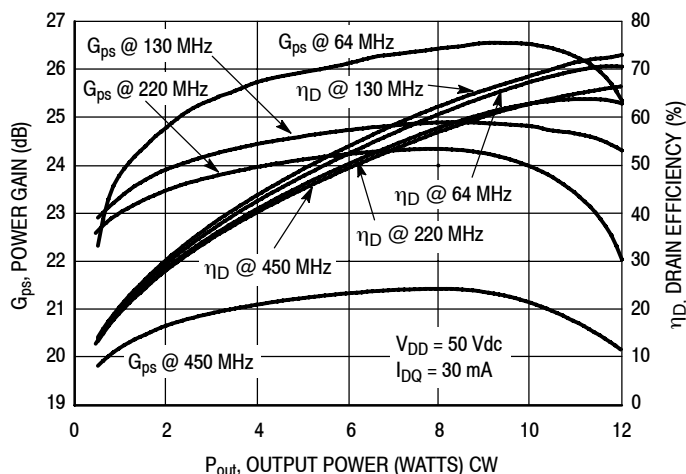
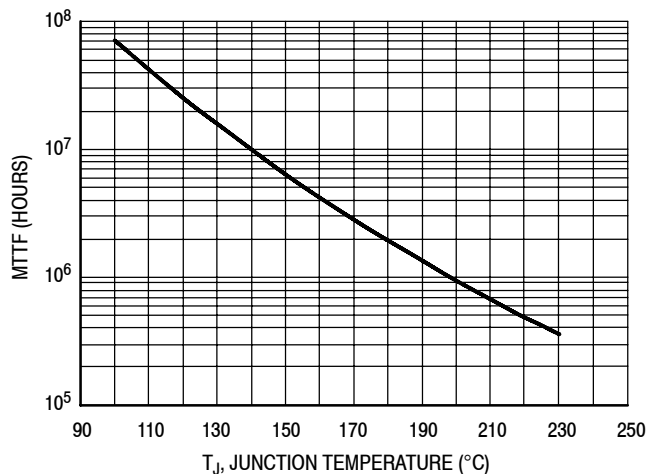

Figure 12. Power Gain and Drain Efficiency versus CW Output Power



This above graph displays calculated MTTF in hours when the device is operated at $V_{DD} = 50 \text{ Vdc}$, $P_{out} = 10 \text{ W CW}$, and $\eta_D = 62\%$.

MTTF calculator available at <http://www.freescale.com/rf>. Select Software & Tools/Development Tools/Calculators to access MTTF calculators by product.

Figure 13. MTTF versus Junction Temperature

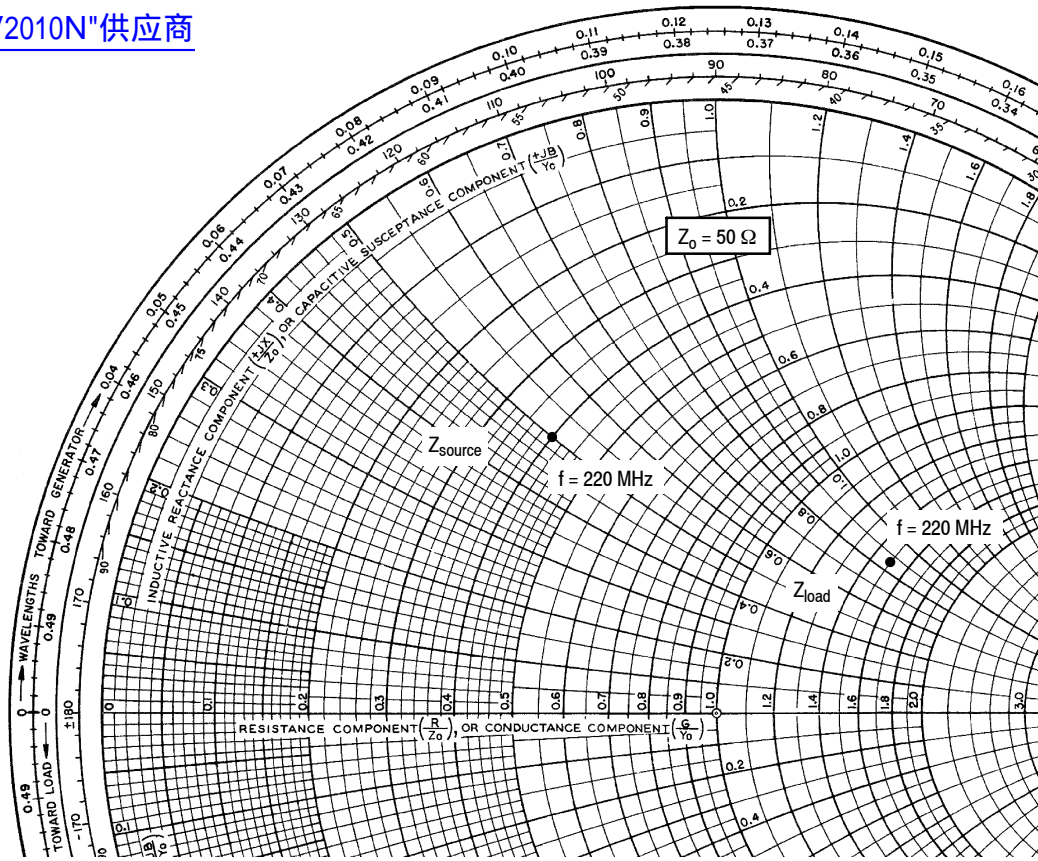

$V_{DD} = 50 \text{ Vdc}$, $I_{DQ} = 30 \text{ mA}$, $P_{out} = 10 \text{ W CW}$

f MHz	Z_{source} Ω	Z_{load} Ω
220	$20 + j25$	$75 + j44$

Z_{source} = Test circuit impedance as measured from gate to ground.

Z_{load} = Test circuit impedance as measured from drain to ground.

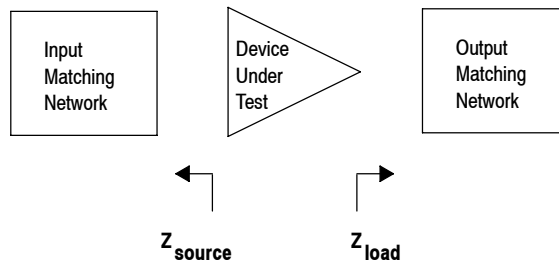

Figure 14. Series Equivalent Source and Load Impedance

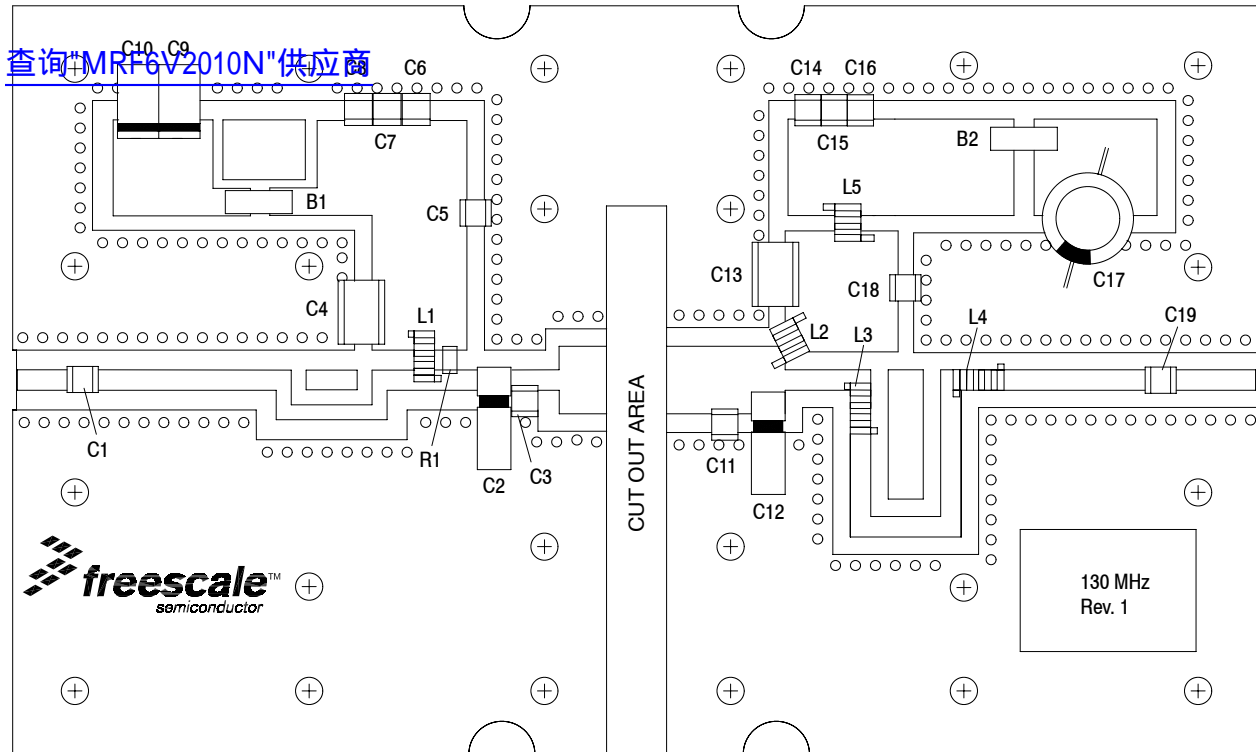

Figure 15. MRF6V2010NR1(NBR1) Test Circuit Component Layout — 130 MHz

Table 7. MRF6V2010NR1(NBR1) Test Circuit Component Designations and Values — 130 MHz

Part	Description	Part Number	Manufacturer
B1, B2	95 Ω , 100 MHz Long Ferrite Beads, Surface Mount	2743021447	Fair-Rite
C1, C5, C18, C19	1000 pF Chip Capacitors	ATC100B102JT50XT	ATC
C2, C12	0.6–4.5 pF Variable Capacitors, Gigatrim	27271SL	Johanson
C3	27 pF Chip Capacitor	ATC100B270JT500XT	ATC
C4, C13	2.2 μ F, 50 V Chip Capacitors	C1825C225J5RAC	Kemet
C6, C14	0.1 μ F, 50 V Chip Capacitors	CDR33BX104AKYM	Kemet
C7, C15	22K pF Chip Capacitors	ATC200B223KT50XT	ATC
C8, C16	39K pF Chip Capacitors	ATC200B393KT50XT	ATC
C9	22 μ F, 35 V Tantalum Capacitor	T491X226K035AT	Kemet
C10	10 μ F, 35 V Tantalum Capacitor	T491D106K035AT	Kemet
C11	16 pF Chip Capacitor	ATC100B160JT500XT	ATC
C17	330 μ F, 63 V Electrolytic Capacitor	MCRH63V337M13X21-RH	Multicomp
L1	17.5 nH Inductor	B06T	CoilCraft
L2, L5	82 nH Inductors	1812SMS-82NJ	CoilCraft
L3	35.5 nH Inductor	B09T	CoilCraft
L4	43 nH Inductor	B10T	CoilCraft
R1	100 Ω , 1/4 W Chip Resistor	CRCW1206100RFKEA	Vishay
PCB	PCB Material 0.030"	CuClad 250GX-0300-55-22, 0.030", $\epsilon_r = 2.55$	Arlon

查询"MRF6V2010N"供应商

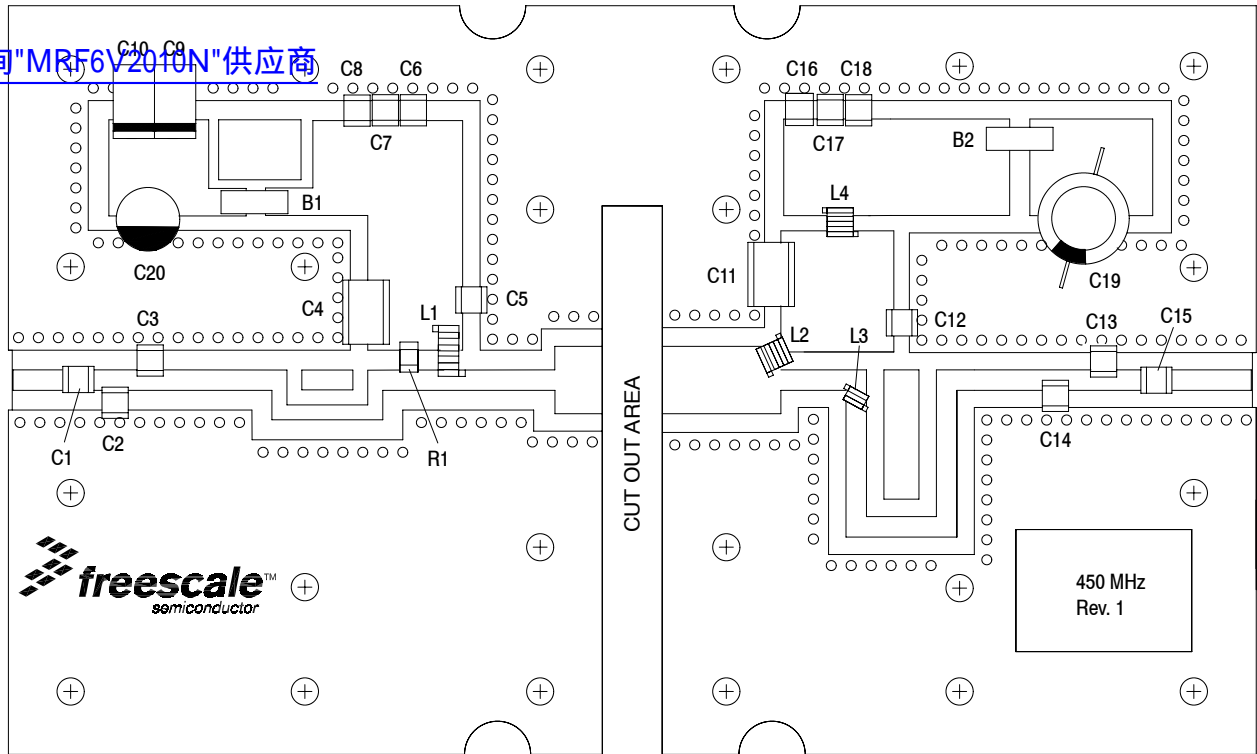

Figure 16. MRF6V2010NR1(NBR1) Test Circuit Component Layout — 450 MHz

Table 8. MRF6V2010NR1(NBR1) Test Circuit Component Designations and Values — 450 MHz

Part	Description	Part Number	Manufacturer
B1, B2	95 Ω , 100 MHz Long Ferrite Beads, Surface Mount	2743021447	Fair-Rite
C1, C5, C12, C15	240 pF Chip Capacitors	ATC100B241JT200XT	ATC
C2, C3	10 pF Chip Capacitors	ATC100B100JT500XT	ATC
C4, C11	2.2 μ F, 50 V Chip Capacitors	C1825C225J5RAC	Kemet
C6, C16	0.1 μ F 50V Chip Capacitors	CDR33BX104AKYM	Kemet
C7, C17	22K pF Chip Capacitors	ATC200B223KT50XT	ATC
C8, C18	39K pF Chip Capacitors	ATC200B393KT50XT	ATC
C9	22 μ F, 35 V Tantalum Capacitor	T491X226K035AT	Kemet
C10	10 μ F, 35 V Tantalum Capacitor	T491D106K035AT	Kemet
C13, C14	6.2 pF Chip Capacitors	ATC100B6R2BT500XT	ATC
C19	470 μ F, 63 V Electrolytic Capacitor	MCGPR63V477M13X26-RH	Multicomp
C20	47 μ F, 50 V Electrolytic Capacitor	476KXM050M	Illinois Cap
L1	17.5 nH Inductor	B06T	CoilCraft
L2, L4	82 nH Inductors	1812SMS-82NJ	CoilCraft
L3	5.0 nH Inductor	A02T	CoilCraft
R1	120 Ω , 1/4 W Chip Resistor	CRCW1206120RFKEA	Vishay
PCB	PCB Material 0.030"	CuClad 250GX-0300-55-22, 0.030", $\epsilon_r = 2.55$	Arlon

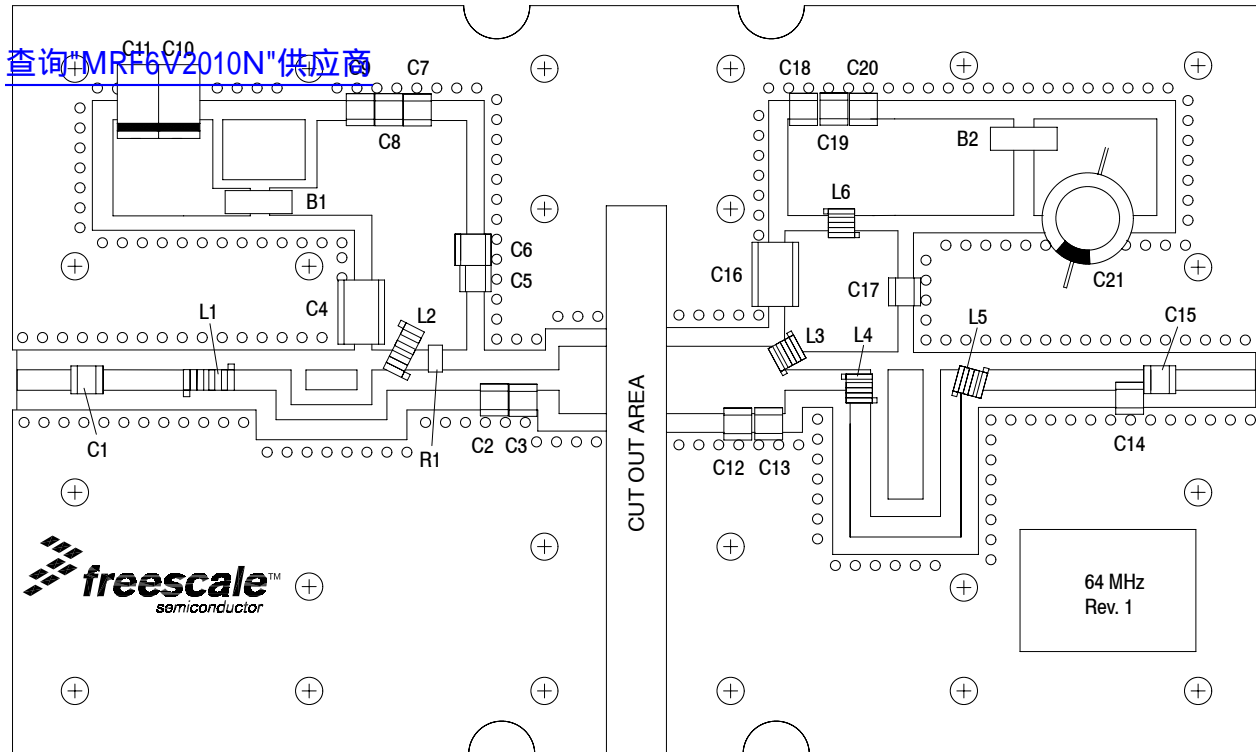
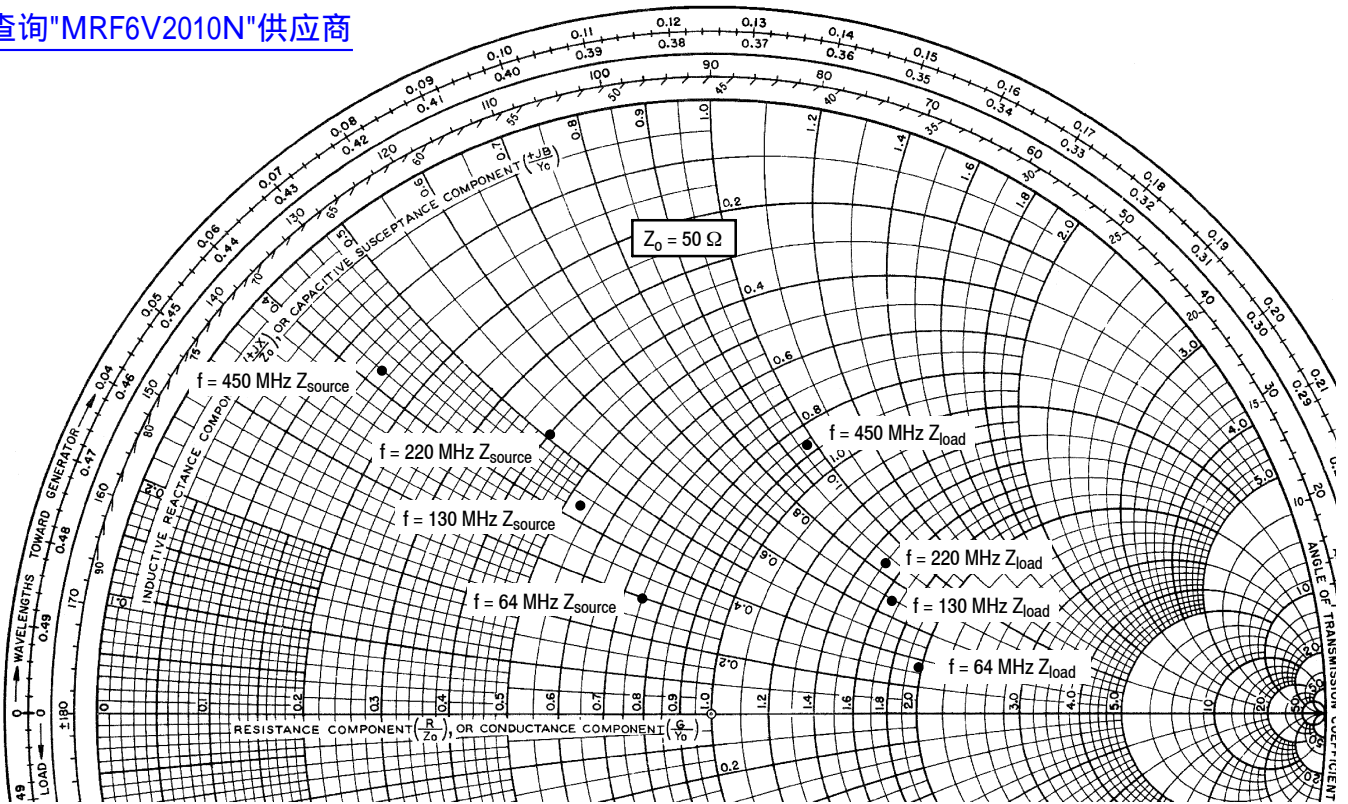

Figure 17. MRF6V2010NR1(NBR1) Test Circuit Component Layout — 64 MHz

Table 9. MRF6V2010NR1(NBR1) Test Circuit Component Designations and Values — 64 MHz

Part	Description	Part Number	Manufacturer
B1, B2	95 Ω , 100 MHz Long Ferrite Beads, Surface Mount	2743021447	Fair-Rite
C1, C5, C15, C17	1000 pF Chip Capacitors	ATC100B102JT50XT	ATC
C2	91 pF Chip Capacitor	ATC100B910JT500XT	ATC
C3, C14	22 pF Chip Capacitors	ATC100B220JT500XT	ATC
C4, C16	2.2 μ F, 50 V Chip Capacitors	C1825C225J5RAC	Kemet
C6	220 nF, 50 V Chip Capacitor	C1812C224J5RAC	Kemet
C7, C18	0.1 μ F, 50 V Chip Capacitors	CDR33BX104AKYM	Kemet
C8, C19	100K pF Chip Capacitors	ATC200B104KT50XT	ATC
C9, C20	22K pF Chip Capacitors	ATC200B223KT50XT	ATC
C10	22 μ F, 35 V Tantalum Capacitor	T491X226K035AT	Kemet
C11	10 μ F, 35 V Tantalum Capacitor	T491D106K035AT	Kemet
C12	68 pF Chip Capacitor	ATC100B680JT500XT	ATC
C13	27 pF Chip Capacitor	ATC100B270JT500XT	ATC
C21	330 μ F, 63 V Electrolytic Capacitor	MCRH63V337M13X21-RH	Multicomp
L1	17.5 nH Inductor	B06T	CoilCraft
L2	43 nH Inductor	B10T	CoilCraft
L3, L4, L5, L6	82 nH Inductors	1812SMS-82NJ	CoilCraft
R1	180 Ω , 1/4 W Chip Resistor	CRCW1206180RFKEA	Vishay
PCB	PCB Material 0.030"	CuClad 250GX-0300-55-22, 0.030", $\epsilon_r = 2.55$	Arlon



$V_{DD} = 50 \text{ Vdc}$, $I_{DQ} = 30 \text{ mA}$, $P_{out} = 10 \text{ W CW}$

f MHz	Z_{source} Ω	Z_{load} Ω
64	$37.5 + j15.1$	$94.5 + j16.7$
130	$26.7 + j21.3$	$83.8 + j35.0$
220	$20.0 + j25.4$	$75.0 + j44.0$
450	$7.70 + j21.0$	$43.0 + j49.0$

Z_{source} = Test circuit impedance as measured from gate to ground.

Z_{load} = Test circuit impedance as measured from drain to ground.

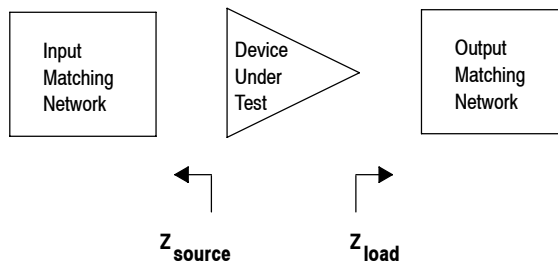

Figure 18. Series Equivalent Source and Load Impedance

50 OHM TYPICAL CHARACTERISTICS

查询"MRF6V2010N"供应商

Table 10. Common Source S-Parameters ($V_{DD} = 50\text{ V}$, $I_{DQ} = 30\text{ mA}$, $T_A = 25^\circ\text{C}$, 50 Ohm System)

f MHz	S ₁₁		S ₂₁		S ₁₂		S ₂₂	
	S ₁₁	∠ φ	S ₂₁	∠ φ	S ₁₂	∠ φ	S ₂₂	∠ φ
10	0.997	-5.0	11.520	175.6	0.000790	84.6	0.960	-0.8
20	0.994	-9.5	11.419	171.6	0.00157	84.3	0.962	-3.5
30	0.992	-14.5	11.356	167.9	0.00232	78.1	0.963	-5.5
40	0.987	-19.3	11.278	164.1	0.00307	74.6	0.964	-7.7
50	0.981	-24.0	11.187	160.1	0.00380	71.0	0.964	-9.9
60	0.974	-28.6	11.042	156.1	0.00449	67.4	0.963	-12.1
70	0.965	-33.0	10.848	152.1	0.00513	63.8	0.961	-14.2
80	0.955	-37.4	10.636	148.2	0.00574	60.4	0.958	-16.3
90	0.944	-41.6	10.405	144.5	0.00631	57.0	0.955	-18.4
100	0.933	-45.7	10.147	140.8	0.00683	53.8	0.951	-20.4
120	0.912	-53.3	9.603	134.2	0.00776	47.9	0.944	-24.2
140	0.892	-60.4	9.061	127.9	0.00851	42.4	0.936	-27.9
160	0.873	-66.7	8.516	122.2	0.00914	37.6	0.929	-31.3
180	0.856	-72.7	7.993	116.9	0.00967	32.9	0.923	-34.6
200	0.841	-78.1	7.497	112.1	0.0101	28.7	0.918	-37.9
220	0.828	-83.0	7.040	107.5	0.0104	24.9	0.914	-41.1
240	0.819	-87.5	6.612	103.3	0.0107	21.3	0.912	-44.2
260	0.810	-91.7	6.214	99.3	0.0109	18.0	0.909	-47.2
280	0.804	-95.5	5.845	95.7	0.0110	15.0	0.908	-50.2
300	0.799	-99.0	5.507	92.2	0.0112	11.9	0.907	-53.0
320	0.796	-102.2	5.192	88.8	0.0112	9.1	0.906	-55.9
340	0.794	-105.1	4.901	85.7	0.0113	6.5	0.906	-58.6
360	0.793	-107.8	4.630	82.8	0.0112	4.1	0.906	-61.4
380	0.793	-110.4	4.382	79.9	0.0112	2.0	0.906	-64.1
400	0.794	-112.7	4.152	77.2	0.0112	-0.3	0.906	-66.7
420	0.796	-114.9	3.937	74.6	0.0112	-2.5	0.907	-69.3
440	0.798	-116.9	3.733	72.2	0.0111	-4.4	0.907	-71.8
460	0.800	-118.8	3.547	69.8	0.0110	-6.5	0.908	-74.2
480	0.803	-120.5	3.372	67.6	0.0109	-8.5	0.908	-76.7
500	0.807	-122.2	3.213	65.4	0.0108	-10.0	0.909	-79.0
520	0.810	-123.8	3.061	63.3	0.0107	-11.9	0.910	-81.3
540	0.814	-125.4	2.919	61.2	0.0105	-13.5	0.911	-83.6
560	0.817	-126.8	2.784	59.3	0.0104	-14.9	0.912	-85.8
580	0.821	-128.1	2.661	57.5	0.0103	-16.6	0.914	-87.9
600	0.825	-129.3	2.545	55.7	0.0101	-18.1	0.915	-90.0
620	0.829	-130.5	2.436	53.9	0.00996	-19.6	0.917	-92.1
640	0.833	-131.6	2.334	52.2	0.00981	-21.0	0.918	-94.1
660	0.837	-132.7	2.237	50.5	0.00963	-22.4	0.920	-96.0
680	0.840	-133.8	2.144	48.9	0.00946	-23.7	0.921	-97.9
700	0.843	-134.8	2.058	47.3	0.00928	-25.0	0.923	-99.7
720	0.847	-135.8	1.977	45.8	0.00910	-26.1	0.924	-101.4
740	0.850	-136.8	1.900	44.4	0.00894	-27.3	0.926	-103.0
760	0.854	-137.8	1.828	43.0	0.00876	-28.6	0.928	-104.7
780	0.857	-138.7	1.760	41.6	0.00859	-29.7	0.930	-106.2

(continued)

50 OHM TYPICAL CHARACTERISTICS

[查询"MRF6V2010N"供应商](#)

Table 10. Common Source S-Parameters ($V_{DD} = 50\text{ V}$, $I_{DQ} = 30\text{ mA}$, $T_A = 25^\circ\text{C}$, 50 Ohm System) (continued)

f MHz	S ₁₁		S ₂₁		S ₁₂		S ₂₂	
	S ₁₁	∠ φ	S ₂₁	∠ φ	S ₁₂	∠ φ	S ₂₂	∠ φ
800	0.858	-139.7	1.697	40.2	0.00839	-31.1	0.932	-107.6
820	0.861	-140.7	1.636	38.9	0.00818	-32.1	0.934	-109.0
840	0.864	-141.6	1.578	37.6	0.00798	-33.1	0.935	-110.4
860	0.867	-142.6	1.523	36.4	0.00781	-33.8	0.936	-111.7
880	0.870	-143.5	1.471	35.1	0.00763	-34.8	0.938	-112.9
900	0.873	-144.5	1.421	33.9	0.00745	-35.9	0.939	-114.1

PACKAGE DIMENSIONS

查询"MRF6V2010N"供应商

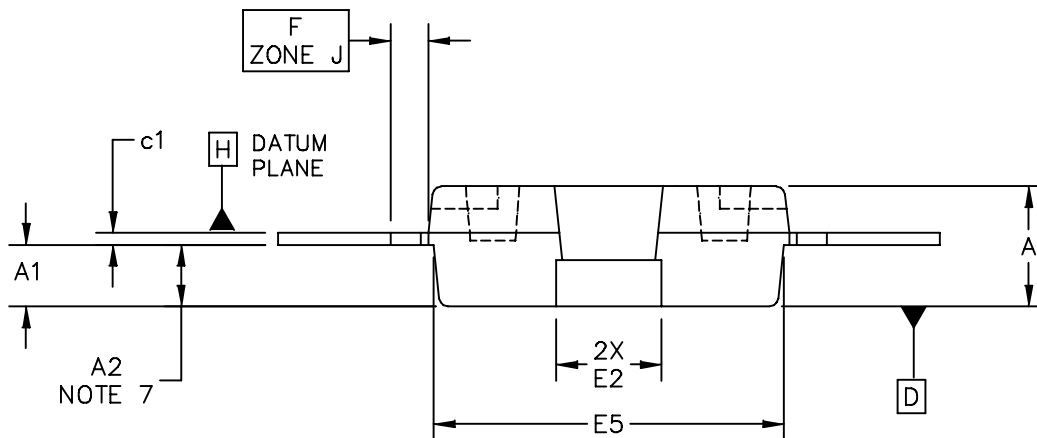
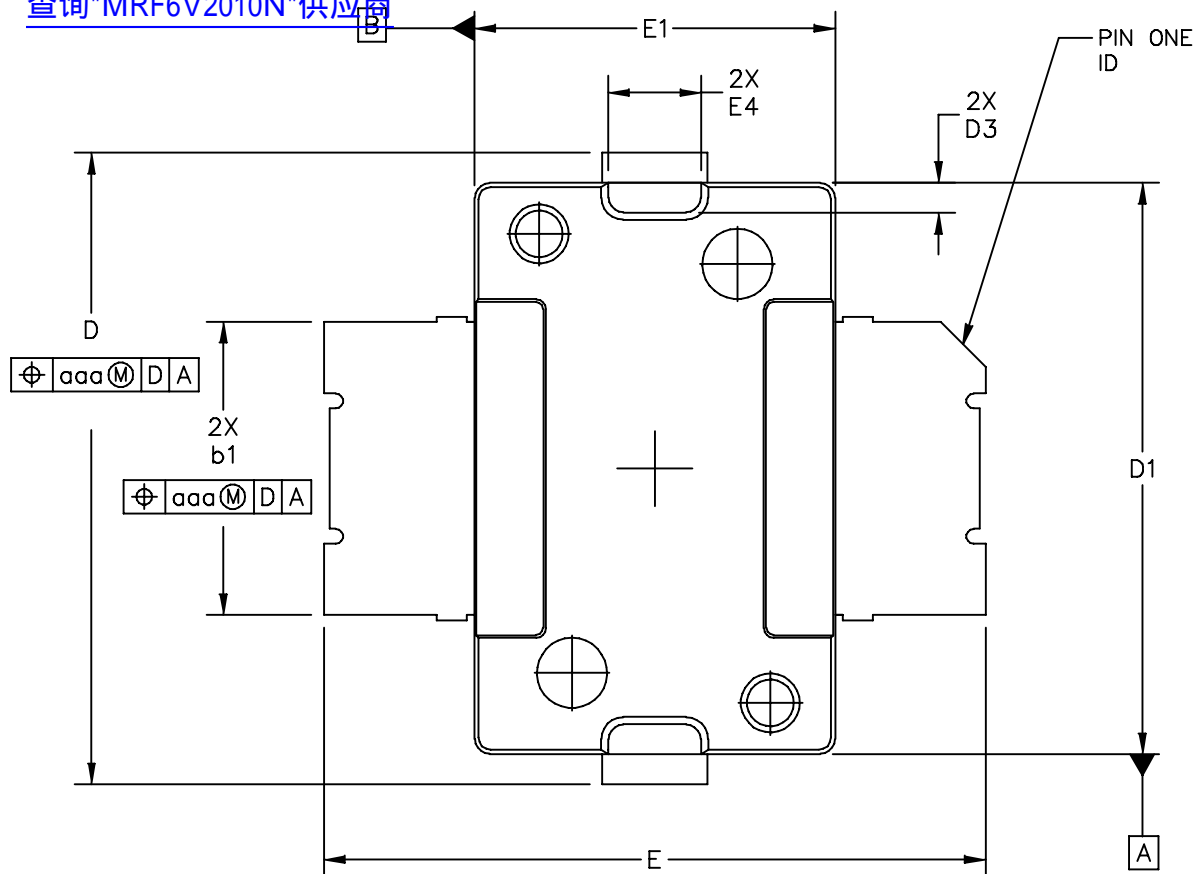

© FREESCALE SEMICONDUCTOR, INC. ALL RIGHTS RESERVED.	MECHANICAL OUTLINE	PRINT VERSION NOT TO SCALE	
TITLE: TO-270 SURFACE MOUNT	DOCUMENT NO: 98ASH98117A	REV: K	
	CASE NUMBER: 1265-09	29 JUN 2007	
	STANDARD: JEDEC TO-270 AA		

[查询"MRF6V2010N"供应商](#)

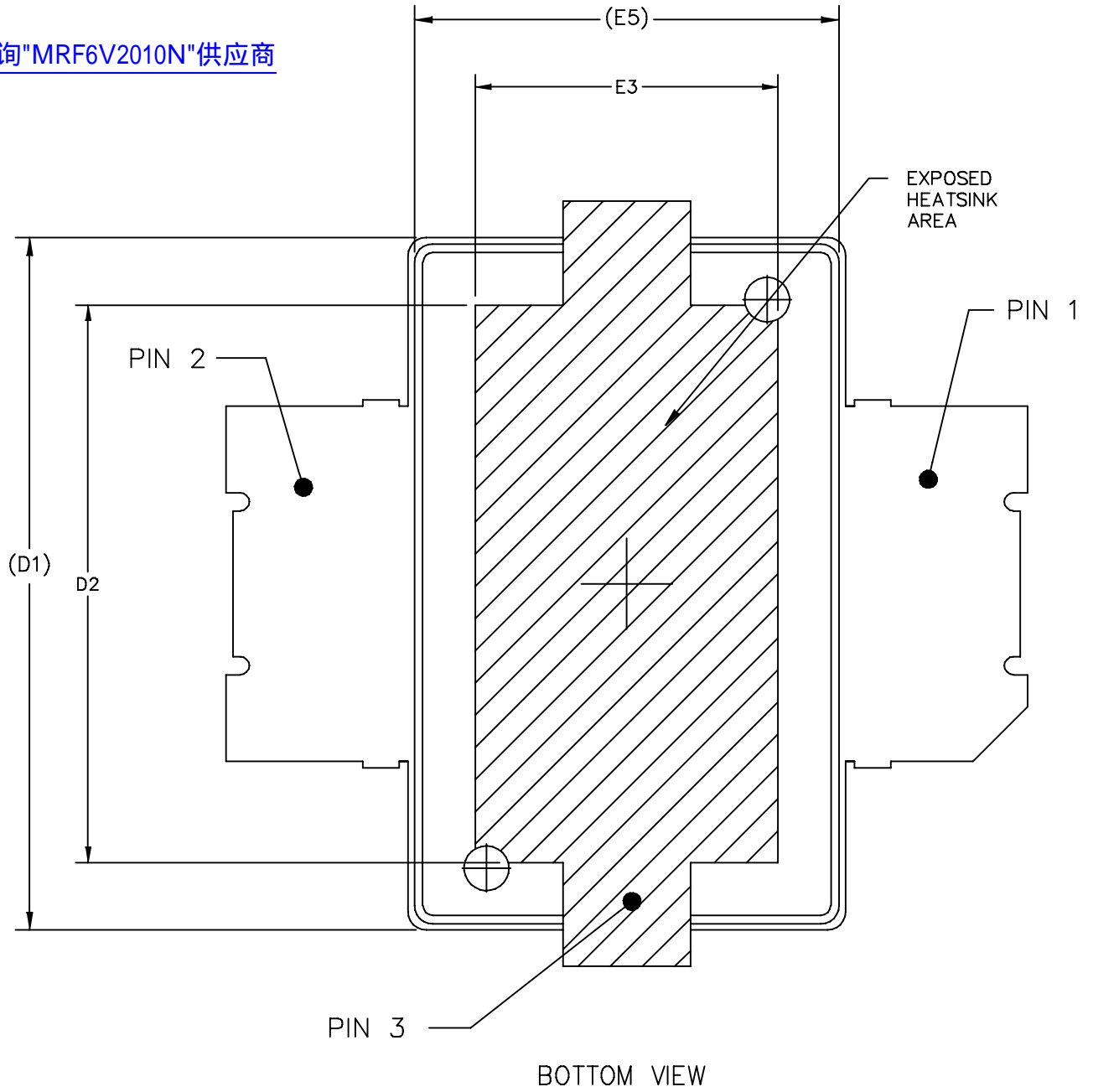

© FREESCALE SEMICONDUCTOR, INC. ALL RIGHTS RESERVED.	MECHANICAL OUTLINE	PRINT VERSION NOT TO SCALE	
TITLE: TO-270 SURFACE MOUNT	DOCUMENT NO: 98ASH98117A	REV: K	
	CASE NUMBER: 1265-09	29 JUN 2007	
	STANDARD: JEDEC TO-270 AA		

MRF6V2010NR1 MRF6V2010NBR1

NOTES:

1. CONTROLLING DIMENSION: INCH
[查询"MRF6V2010N"供应商](#)
2. INTERPRET DIMENSIONS AND TOLERANCES PER ASME Y14.5M-1994.
3. DATUM PLANE -H- IS LOCATED AT TOP OF LEAD AND IS COINCIDENT WITH THE LEAD WHERE THE LEAD EXITS THE PLASTIC BODY AT THE TOP OF THE PARTING LINE.
4. DIMENSIONS "D1" AND "E1" DO NOT INCLUDE MOLD PROTRUSION. ALLOWABLE PROTRUSION IS .006 PER SIDE. DIMENSIONS "D1 AND "E1" DO INCLUDE MOLD MISMATCH AND ARE DETERMINED AT DATUM PLANE -H-.
5. DIMENSION "b1" DOES NOT INCLUDE DAMBAR PROTRUSION. ALLOWABLE DAMBAR PROTRUSION SHALL BE .005 TOTAL IN EXCESS OF THE "b1" DIMENSION AT MAXIMUM MATERIAL CONDITION.
6. DATUMS -A- AND -B- TO BE DETERMINED AT DATUM PLANE -H-.
7. DIMENSION "A2" APPLIES WITHIN ZONE "J" ONLY.
8. DIMENSIONS "D" AND "E2" DO NOT INCLUDE MOLD PROTRUSION. OVERALL LENGTH INCLUDING MOLD PROTRUSION SHOULD NOT EXCEED 0.430 INCH FOR DIMENSION "D" AND 0.080 INCH FOR DIMENSION "E2". DIMENSIONS "D" AND "E2" DO INCLUDE MOLD MISMATCH AND ARE DETERMINED AT DATUM PLANE -D-.

STYLE 1:
 PIN 1 - DRAIN
 PIN 2 - GATE
 PIN 3 - SOURCE

DIM	INCH		MILLIMETER		DIM	INCH		MILLIMETER	
	MIN	MAX	MIN	MAX		MIN	MAX	MIN	MAX
A	.078	.082	1.98	2.08	F	.025 BSC		0.64 BSC	
A1	.039	.043	0.99	1.09	b1	.193	.199	4.90	5.06
A2	.040	.042	1.02	1.07	c1	.007	.011	0.18	0.28
D	.416	.424	10.57	10.77	aaa	.004		0.10	
D1	.378	.382	9.60	9.70					
D2	.290	----	7.37	----					
D3	.016	.024	0.41	0.61					
E	.436	.444	11.07	11.28					
E1	.238	.242	6.04	6.15					
E2	.066	.074	1.68	1.88					
E3	.150	----	3.81	----					
E4	.058	.066	1.47	1.68					
E5	.231	.235	5.87	5.97					

© FREESCALE SEMICONDUCTOR, INC. ALL RIGHTS RESERVED.		MECHANICAL OUTLINE		PRINT VERSION NOT TO SCALE	
TITLE: TO-270 SURFACE MOUNT		DOCUMENT NO: 98ASH98117A		REV: K	
		CASE NUMBER: 1265-09		29 JUN 2007	
		STANDARD: JEDEC TO-270 AA			

查询"MRF6V2010N"供应商

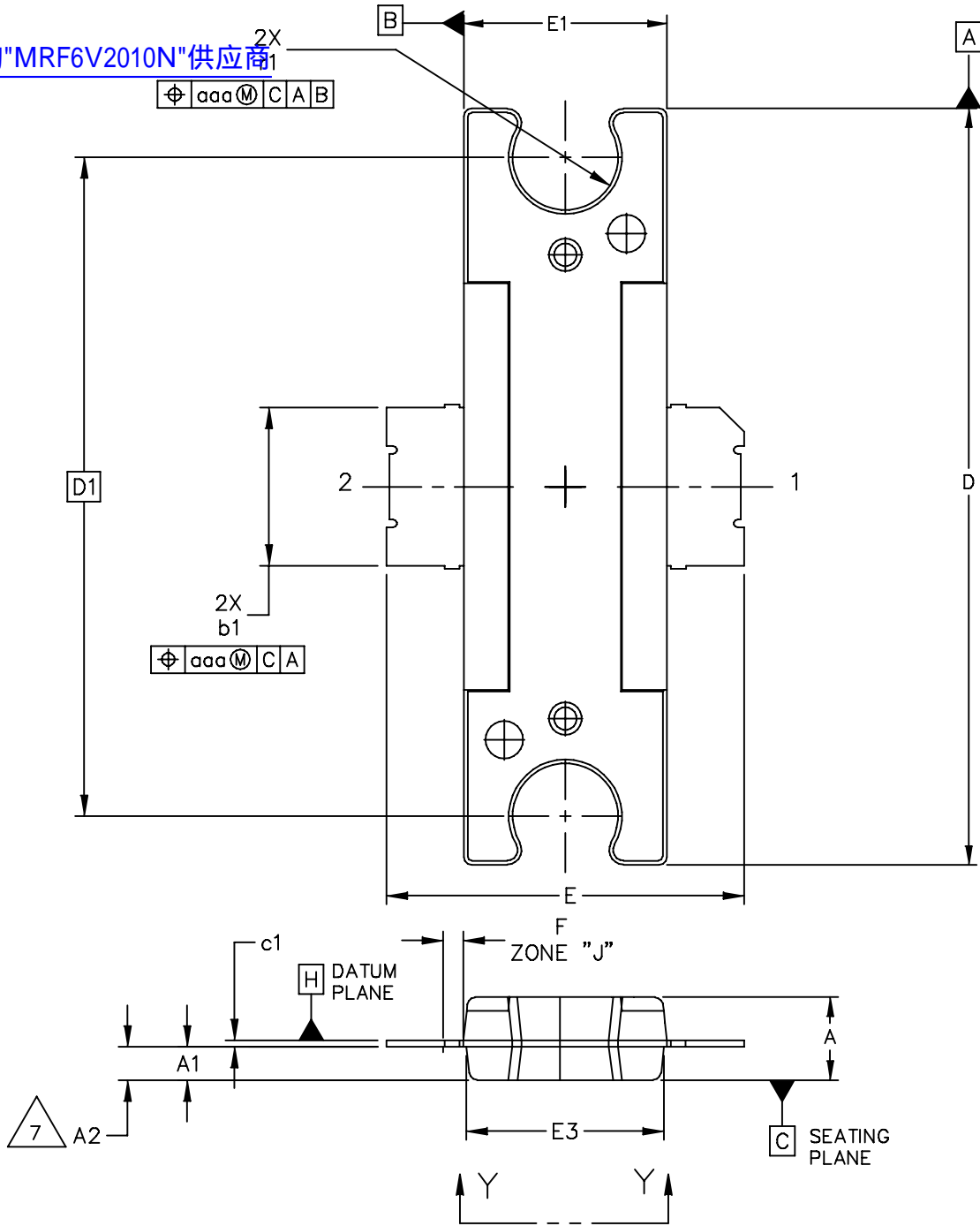

© FREESCALE SEMICONDUCTOR, INC. ALL RIGHTS RESERVED.		MECHANICAL OUTLINE		PRINT VERSION NOT TO SCALE	
TITLE: TO-272 2 LEAD		DOCUMENT NO: 98ASA99191D		REV: E	
		CASE NUMBER: 1337-04		10 SEP 2007	
		STANDARD: JEDEC TO-272 BC			

[查询"MRF6V2010N"供应商](#)

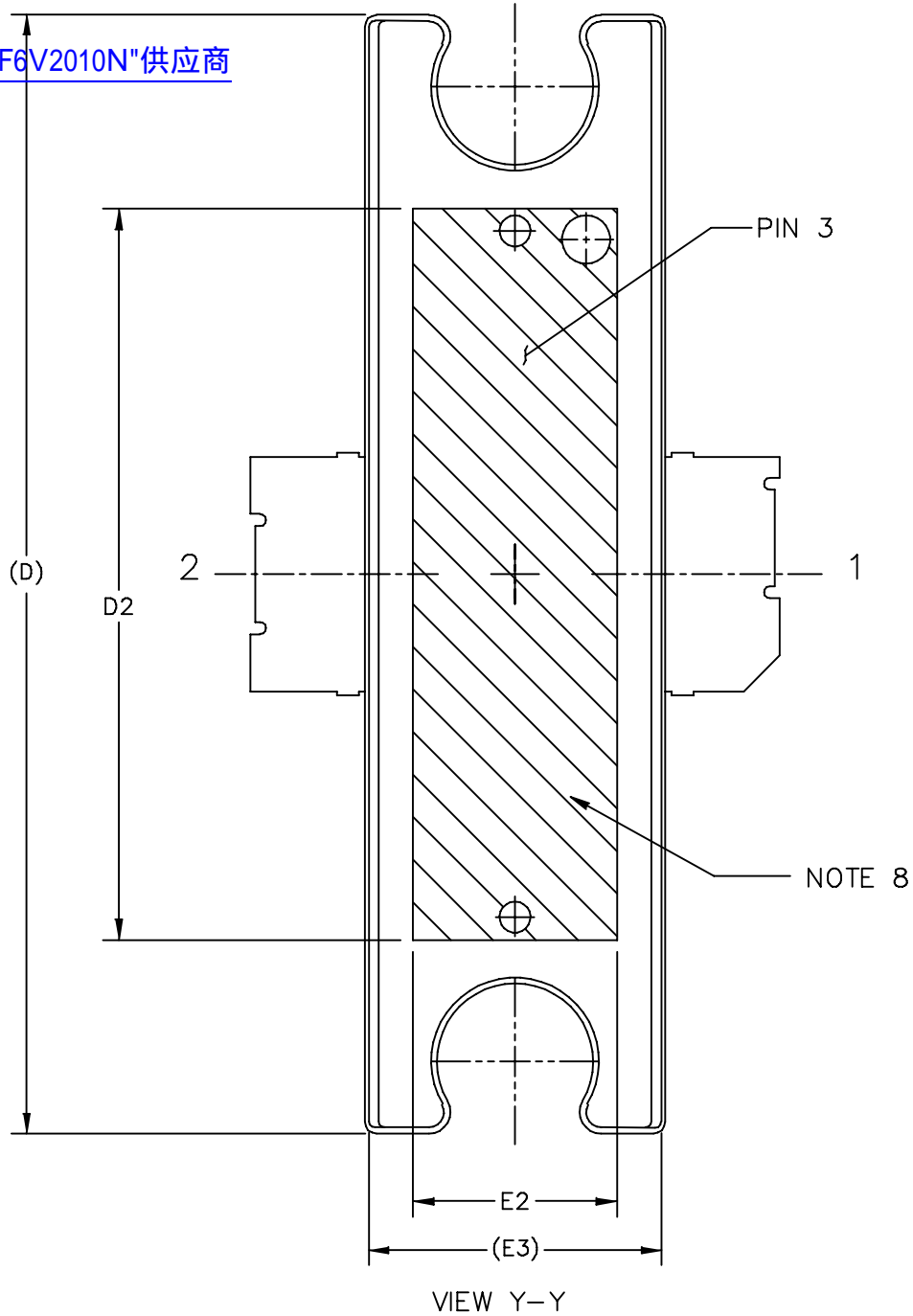

VIEW Y-Y

© FREESCALE SEMICONDUCTOR, INC. ALL RIGHTS RESERVED.		MECHANICAL OUTLINE	PRINT VERSION NOT TO SCALE
TITLE: TO-272 2 LEAD	DOCUMENT NO: 98ASA99191D		REV: E
	CASE NUMBER: 1337-04		10 SEP 2007
	STANDARD: JEDEC TO-272 BC		

NOTES:

[查询"MRF6V2010N"供应商](#) CONTROL TOLERANCE DIMENSION: INCH

2. INTERPRET DIMENSIONS AND TOLERANCES PER ASME Y14.5M-1994.
3. DATUM PLANE -H- IS LOCATED AT THE TOP OF LEAD AND IS COINCIDENT WITH THE LEAD WHERE THE LEAD EXITS THE PLASTIC BODY AT THE TOP OF THE PARTING LINE.
4. DIMENSIONS "D" AND "E1" DO NOT INCLUDE MOLD PROTRUSION. ALLOWABLE PROTRUSION IS .006 PER SIDE. DIMENSIONS "D" AND "E1" DO INCLUDE MOLD MISMATCH AND ARE DETERMINED AT DATUM PLANE -H-.
5. DIMENSIONS "b1" DOES NOT INCLUDE DAMBAR PROTRUSION. ALLOWABLE DAMBAR PROTRUSION SHALL BE .005 TOTAL IN EXCESS OF THE "b1" DIMENSION AT MAXIMUM MATERIAL CONDITION.
6. DATUMS -A- AND -B- TO BE DETERMINED AT DATUM PLANE -H-.
7. DIMENSION A2 APPLIES WITHIN ZONE "J" ONLY.
8. HATCHING REPRESENTS THE EXPOSED AREA OF THE HEAT SLUG.

STYLE 1:
 PIN 1 - DRAIN
 PIN 2 - GATE
 PIN 3 - SOURCE

DIM	INCH		MILLIMETER		DIM	INCH		MILLIMETER	
	MIN	MAX	MIN	MAX		MIN	MAX	MIN	MAX
A	.100	.104	2.54	2.64	b1	.193	.199	4.90	5.05
A1	.039	.043	0.99	1.09	c1	.007	.011	0.18	0.28
A2	.040	.042	1.02	1.07	r1	.063	.068	1.60	1.73
D	.928	.932	23.57	23.67	aaa	.004		0.1	
D1	.810 BSC		20.57 BSC						
D2	.604	----	15.34	----					
E	.438	.442	11.12	11.23					
E1	.248	.252	6.30	6.40					
E2	.162	----	4.11	----					
E3	.241	.245	6.12	6.22					
F	.025 BSC		0.64 BSC						
© FREESCALE SEMICONDUCTOR, INC. ALL RIGHTS RESERVED.			MECHANICAL OUTLINE			PRINT VERSION NOT TO SCALE			
TITLE: TO-272 2 LEAD					DOCUMENT NO: 98ASA99191D			REV: E	
					CASE NUMBER: 1337-04			10 SEP 2007	
					STANDARD: JEDEC TO-272 BS				

PRODUCT DOCUMENTATION AND SOFTWARE

[查询"MRF6V2010N"供应商](#)

Refer to the following documents to aid your design process.

Application Notes

- AN1907: Solder Reflow Attach Method for High Power RF Devices in Plastic Packages
- AN1955: Thermal Measurement Methodology of RF Power Amplifiers
- AN3263: Bolt Down Mounting Method for High Power RF Transistors and RFICs in Over-Molded Plastic Packages

Engineering Bulletins

- EB212: Using Data Sheet Impedances for RF LDMOS Devices

Software

- Electromigration MTTF Calculator
- RF High Power Model

For Software, do a Part Number search at <http://www.freescale.com>, and select the "Part Number" link. Go to the Software & Tools tab on the part's Product Summary page to download the respective tool.

REVISION HISTORY

The following table summarizes revisions to this document.

Revision	Date	Description
0	Feb. 2007	<ul style="list-style-type: none"> • Initial Release of Data Sheet
1	May 2007	<ul style="list-style-type: none"> • Corrected Test Circuit Component part numbers in Table 6, Component Designations and Values for C1, C8, C11, C18, C4, C13, C5, and C14, p. 3 • Corrected Series Impedance Z_{source} and Z_{load} values, Fig. 13, Series Equivalent Source and Load Impedance, p. 7
2	Aug. 2007	<ul style="list-style-type: none"> • Replaced Case Outline 1265-08 with 1265-09, Issue K, p. 1, 12-14. Corrected cross hatch pattern in bottom view and changed its dimensions (D2 and E3) to minimum value on source contact (D2 changed from Min-Max .290-.320 to .290 Min; E3 changed from Min-Max .150-.180 to .150 Min). Added JEDEC Standard Package Number. • Replaced Case Outline 1337-03 with 1337-04, p. 1, 15-17. Issue D: Removed Drain-ID label from View Y-Y on Sheet 2. Renamed E2 to E3. Added cross-hatch region dimensions D2 and E2. • Corrected Test Circuit Component part number in Table 6, Component Designations and Values for R1, p. 3 • Added Figure 12, Power Gain and Drain Efficiency versus CW Output Power, p. 6 • Corrected plot points to show 50 Ohms in Figure 14, Series Equivalent Source and Load Impedance, p. 7 • Added Figures 15-17, Test Circuit Component Layout and Tables 7-9, Test Circuit Component Designations and Values to show 130, 450 and 64 MHz, respectively, p. 8-10 • Added Figure 18, Series Equivalent Source and Load Impedance to show 64, 130, 220 and 450 MHz plot points, p. 11
3	Feb. 2008	<ul style="list-style-type: none"> • Added Case Operating Temperature limit to the Maximum Ratings table and set limit to 150°C, p. 1 • Corrected C_{iss} test condition to indicate AC stimulus on the V_{GS} connection versus the V_{DS} connection, Dynamic Characteristics table, p. 2 • Replaced Case Outline 1337-04, Issue D, with 1337-04, Issue E, p. 15-17. Corrected document number 98ASA99191D on Sheet 3.
4	Mar. 2008	<ul style="list-style-type: none"> • Corrected Z_{source} (37.5 + j15.1) and Z_{load} (94.5 + j16.7) 64 MHz values and replotted both, p. 11 • Added S-Parameter table, p. 12, 13
5	Apr. 2010	<ul style="list-style-type: none"> • Operating Junction Temperature increased from 200°C to 225°C in Maximum Ratings table, related "Continuous use at maximum temperature will affect MTTF" footnote added and changed 200°C to 225°C in Capable Plastic Package bullet, p. 1 • Added Electromigration MTTF Calculator and RF High Power Model availability to Product Software, p. 20

How to Reach Us:

Home Page:

www.freescale.com

Web Support:

<http://www.freescale.com/support>

USA/Europe or Locations Not Listed:

Freescale Semiconductor, Inc.
Technical Information Center, EL516
2100 East Elliot Road
Tempe, Arizona 85284
1-800-521-6274 or +1-480-768-2130
www.freescale.com/support

Europe, Middle East, and Africa:

Freescale Halbleiter Deutschland GmbH
Technical Information Center
Schatzbogen 7
81829 Muenchen, Germany
+44 1296 380 456 (English)
+46 8 52200080 (English)
+49 89 92103 559 (German)
+33 1 69 35 48 48 (French)
www.freescale.com/support

Japan:

Freescale Semiconductor Japan Ltd.
Headquarters
ARCO Tower 15F
1-8-1, Shimo-Meguro, Meguro-ku,
Tokyo 153-0064
Japan
0120 191014 or +81 3 5437 9125
support.japan@freescale.com

Asia/Pacific:

Freescale Semiconductor China Ltd.
Exchange Building 23F
No. 118 Jianguo Road
Chaoyang District
Beijing 100022
China
+86 10 5879 8000
support.asia@freescale.com

For Literature Requests Only:

Freescale Semiconductor Literature Distribution Center
1-800-441-2447 or +1-303-675-2140
Fax: +1-303-675-2150
LDCForFreescaleSemiconductor@hibbertgroup.com

Information in this document is provided solely to enable system and software implementers to use Freescale Semiconductor products. There are no express or implied copyright licenses granted hereunder to design or fabricate any integrated circuits or integrated circuits based on the information in this document.

Freescale Semiconductor reserves the right to make changes without further notice to any products herein. Freescale Semiconductor makes no warranty, representation or guarantee regarding the suitability of its products for any particular purpose, nor does Freescale Semiconductor assume any liability arising out of the application or use of any product or circuit, and specifically disclaims any and all liability, including without limitation consequential or incidental damages. "Typical" parameters that may be provided in Freescale Semiconductor data sheets and/or specifications can and do vary in different applications and actual performance may vary over time. All operating parameters, including "Typicals", must be validated for each customer application by customer's technical experts. Freescale Semiconductor does not convey any license under its patent rights nor the rights of others. Freescale Semiconductor products are not designed, intended, or authorized for use as components in systems intended for surgical implant into the body, or other applications intended to support or sustain life, or for any other application in which the failure of the Freescale Semiconductor product could create a situation where personal injury or death may occur. Should Buyer purchase or use Freescale Semiconductor products for any such unintended or unauthorized application, Buyer shall indemnify and hold Freescale Semiconductor and its officers, employees, subsidiaries, affiliates, and distributors harmless against all claims, costs, damages, and expenses, and reasonable attorney fees arising out of, directly or indirectly, any claim of personal injury or death associated with such unintended or unauthorized use, even if such claim alleges that Freescale Semiconductor was negligent regarding the design or manufacture of the part.

Freescale™ and the Freescale logo are trademarks of Freescale Semiconductor, Inc. All other product or service names are the property of their respective owners.

© Freescale Semiconductor, Inc. 2007-2008, 2010. All rights reserved.