

**Fuseholder
Type FIO and FIN**

front side,
fixing nut fastening
shocksafe category PC2
degree of protection/IEC 60529:
FIO: IP40 or IP 65 from front
FIN: IP67 from front and rear



0031.1361/81



0031.1353/63/83



0031.1351

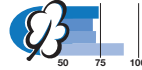

- screw type fuse carrier, slotted
- solder-/quick-conn. term. 2,8 x 0,5 mm
- suitable for equipment with protection classes I and II according to IEC 60536

Technical data





- Rated voltage: 250 V
- Rated current: 10 A
- Rated power acceptance at ambient air temperature T_a 23 °C: 2,5 W
- Power acceptance at higher T_a : see derating curves
- Take note of the information on pages 215–219
- Allowable ambient air temperatures T_a for accessible parts: -40 °C to +85 °C
- Contact resistance: 5 mΩ
- Dielectric strength: > 4 kV, 50 Hz, 1 Min.*
- Insulation resistance (500 V DC/1 Min): FIO: > 102 MΩ, FIN: > 103 MΩ
- Torque/Fixing nut: max. 1,2 Nm
- Torque/screw type fuse-carrier: max. 0,35 Nm
- Materials
socket: thermoset, UL 94 V-0
fuse carrier: thermoset, UL 94-HB

* between metal mounting plate and live parts

Standards

IEC 60127-6 (formerly IEC 257),
EN 60127-6 (formerly EN 60257), UL 512, CSA C22.2-39

Approvals, Patents

- | | | | | | |
|--|-------|--------------|---|-----|--------------|
|  | SEV | (10 A/250 V) |  | UL | (10 A/250 V) |
|  | VDE | (10 A/250 V) |  | CSA | (10 A/250 V) |
|  | SEMCO | (10 A/250 V) | | | |

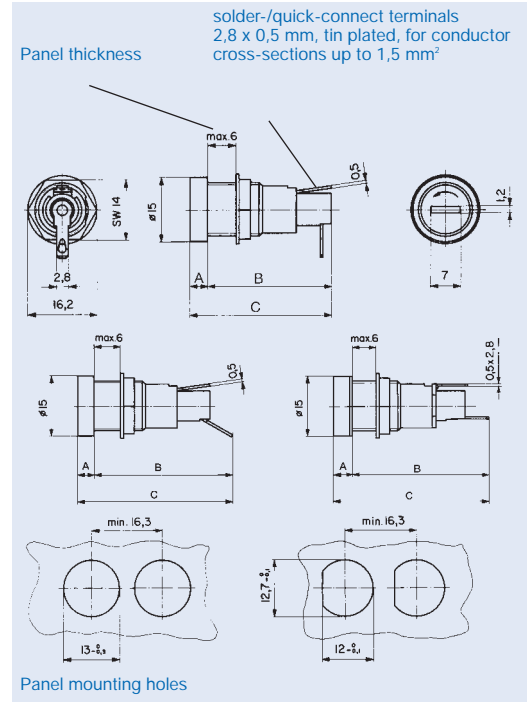

Type	Order no.	Dimensions		
		A	B	C
FIO	0031.1361	4,6	30,9	35,5
	0031.1363	4,6	28,4	33
	0031.1381	4	31,5	35,5
FIN	0031.1383	4	29	33
	0031.1351	4,6	34,5	39,1
	0031.1353	4,6	29,4	34

Derating curve

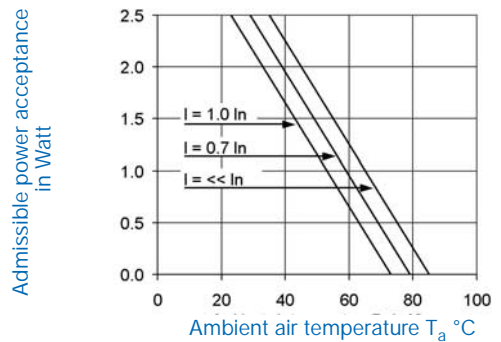

Order No.	Type		to Fuseholder	Degree of protection	Position of the end-terminal
0031.1361	FIO	Fuseholder complete, black		IP65	30°
0031.1363	FIO	Fuseholder complete, black		IP65	90°
0031.1381	FIO	Fuseholder complete, black		IP40	30°
0031.1383	FIO	Fuseholder complete, black		IP40	90°
0031.1351	FIN	Fuseholder complete, black		IP67	straight
0031.1353	FIN	Fuseholder complete, black		IP67	90°
0031.1371		Fuse carrier, screw type, black	0031.1361/63 0031.1351/53		
0031.1372		Fuse carrier, screw type, black	0031.1381/83		

Accessories see page 183