

GR900 and MIL-PRF-123 High-Reliability Ceramic Capacitors are available. Refer to catalog F-3054 for detailed information. KEMET also manufactures Tantalum Leaded, and Surface Mount Capacitors — Tantalum and Ceramic. Refer to catalog F-3100 — Tantalum Leaded, and F3102 — Surface Mount for detailed information on these products.

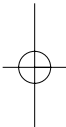

Environmental	.13
Ceramic Molded Standard/Axial & Radial	
Outline Drawing	.14
Dimensions	.14
Ordering Information	.15
Marking	.15
Part Number Reference	.16 - 19
Mil-PRF-20	
Outline Drawings	.20
Dimensions	.20
Ordering Information	.21
Marking	.21
Part Number Reference	.22 - 25
Mil-C-11015 (CK) & Mil-PRF-39014 (CKR)	
Outline Drawings	.26
Dimensions	.26
Ordering Information	.27
Marking	.27
Part Number Reference	.28 - 31
Ceramic Axial Tape & Reel Packaging Specifications	.32
Ceramic Radial Tape & Reel Packaging Specifications	.33
Ceramic Leaded Packaging Quantities	.34
Application Notes for Multilayer Ceramic Capacitors	.35 - 39

NOTICE

Although the information in this catalog has been carefully checked for accuracy, and is believed to be correct and current, no warranty, either express or implied, is made as to either its applicability to, or its compatibility with, specific requirements; nor does KEMET Electronics Corporation assume any responsibility for correctness of this information, nor for damages consequent to its use. All design characteristics, specifications, tolerances, and the like are subject to change without notice.

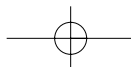

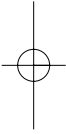

Class II: Stable capacitors, suitable for bypass or coupling applications or frequency discriminating circuits where Q and stability of capacitance characteristics are not of a major importance. Class II capacitors have temperature characteristics of $\pm 15\%$ or less. They are made from materials which are ferro-electric, yielding higher volumetric efficiency but less stability. Class II capacitors are affected by temperature, voltage, frequency and time.

known as NPO).

X7R: Class II, with a maximum capacitance change of $\pm 15\%$ over an operating temperature range of -55°C to $+125^{\circ}\text{C}$.

Z5U: Class III, with a maximum capacitance change of $+22\% - 56\%$ over an operating temperature range of $+10^{\circ}\text{C}$ to $+85^{\circ}\text{C}$.

Specified electrical limits for these three temperature characteristics are shown in Table 1.

SPECIFIED ELECTRICAL LIMITS

PARAMETER	TEMPERATURE CHARACTERISTICS		
	C0G	X7R	Z5U
Dissipation Factor: Measured at following conditions: C0G — 1 kHz and 1 vrms if capacitance > 1000 pF 1 MHz and 1 vrms if capacitance \leq 1000 pF X7R — 1 kHz and 1 vrms* Z5U — 1 kHz and 0.5 vrms	0.15%	2.5%	4.0%
Dielectric Strength: 2.5 times rated DC voltage.	Pass Subsequent IR Test		
Insulation Resistance (IR): At rated DC voltage, whichever of the two is smaller	1,000 M Ω - μF or 100 G Ω	1,000 M Ω - μF or 100 G Ω	1,000 M Ω - μF or 10 G Ω
Temperature Characteristics: Range, $^{\circ}\text{C}$ Capacitance Change without DC voltage	-55 to 125 0 ± 30 ppm/ $^{\circ}\text{C}$	-55 to 125 $\pm 15\%$	+10 to 85 $+22\%, -56\%$

* 1 MHz and 1 vrms if capacitance \leq 100 pF on military product.

Table I

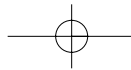

ELECTRICAL @ 25°C

Capacitance:

Within specified tolerance at 25°C and following test conditions.

- C0G - Greater than 1000 pF with 1.0 vrms at 1 kHz.
- 1000 pF and less with 1.0 vrms at 1 MHz.
- X7R - with 1.0 vrms at 1 kHz.
- Z5U - with 0.5 vrms at 1 kHz.

Dissipation Factor:

At 25°C - same test conditions as capacitance.

- C0G - 0.15% maximum
- X7R - 2.5% maximum
- Z5U - 4.0% maximum

Insulation Resistance:

EIA RS-198D, Method 104, Condition A

- C0G - 100 gigohms or 1000 megohm x μF ,
whichever is less.
- X7R - 100 gigohms or 1000 megohm x μF ,
whichever is less.
- Z5U - 10 gigohms or 1000 megohm x μF ,
whichever is less.

Dielectric Withstanding Voltage:

EIA RS-198D, Method 103 (250% of rated voltage for 5 seconds, with current limited to 50mA)

ENVIRONMENTAL

Vibration:

EIA RS-198D, Method 304, Condition D (10-2000 Hz; 20g)

Shock:

EIA RS-198D, Method 305, Condition I (100g)

Post-Test Limits at + 25°C are:

Capacitance Change:

- C0G - 3%, or 0.25 pF, whichever is greater.
- X7R - $\pm 20\%$ of initial value. ⁽²⁾
- Z5U - $\pm 30\%$ of initial value. ⁽²⁾

Dissipation Factor:

- C0G - 0.25% maximum
- X7R - 3.0% maximum
- Z5U - 4.0% maximum

Insulation Resistance:

- C0G - 10 gigohms or 100 megohm x μF ,
whichever is less.
- X7R - 10 gigohms or 100 megohm x μF ,
whichever is less.
- Z5U - 1 gigohm or 100 megohm x μF ,
whichever is less.

Thermal Shock:

EIA RS-198D, Method 202, Condition B (C0G & X7R: - 55°C to + 125°C; Z5U: - 55°C to + 85°C)

- (1) +53 ppm -30 ppm/°C from + 25°C to - 55°C, ± 60 ppm below 10 pF.
- (2) X7R & Z5U dielectrics exhibit aging characteristics; therefore, it is highly recommended that capacitors be deaged for 2 hours at 150°C and stabilized at room temperature for 48 hours before capacitance measurements are made.

CERAMIC

CASE SIZE
(See Table of Dimensions above)

SPECIFICATION
C — Standard

CAPACITANCE
Expressed in Picofarad Code (pF)
First Two Digits — Significant Figures
Third Digit — Number of Zeros

CAPACITANCE TOLERANCE
J — ±5%
K — ±10%
M — ±20%
Z — -20 +80%

FAILURE RATE
A — Not Applicable

LEAD MATERIAL
C — Standard

INTERNAL CONSTRUCTION
5 — Standard

DIELECTRIC
EIA Designation
G — C0G (NPO) — Ultra-Stable
R — X7R — Stable
U — Z5U — General Purpose

RATED VOLTAGE
1 — 100 Volts
5 — 50 Volts

***Part Number Example: C410C104M5U5CA (14 digits – no spaces)**

MARKING INFORMATION

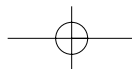
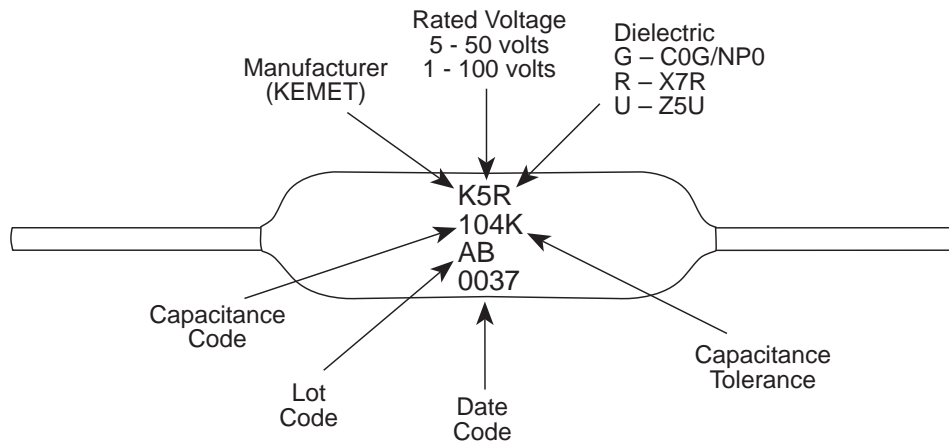

820	C410C821(1)1G5CA
1,000	C410C102(1)1G5CA
1,200	C420C122(1)1G5CA
1,500	C420C152(1)1G5CA
1,800	C420C182(1)1G5CA
2,200	C420C222(1)1G5CA
2,700	C430C272(1)1G5CA
3,300	C430C332(1)1G5CA
3,900	C430C392(1)1G5CA
4,700	C430C472(1)1G5CA
5,600	C430C562(1)1G5CA
6,800	C430C682(1)1G5CA
8,200	C430C822(1)1G5CA
10,000	C440C103(1)1G5CA
12,000	C440C123(1)1G5CA
15,000	C440C153(1)1G5CA
50 VOLT - C0G	
560	C410C561(1)5G5CA
680	C410C681(1)5G5CA
820	C410C821(1)5G5CA
1,000	C410C102(1)5G5CA
1,200	C412C122(1)5G5CA
1,500	C412C152(1)5G5CA
1,800	C412C182(1)5G5CA
2,200	C412C222(1)5G5CA
2,700	C412C272(1)5G5CA
1,200	C420C122(1)5G5CA
1,500	C420C152(1)5G5CA
1,800	C420C182(1)5G5CA
2,200	C420C222(1)5G5CA
2,700	C430C272(1)5G5CA
3,300	C430C332(1)5G5CA
3,900	C430C392(1)5G5CA
4,700	C430C472(1)5G5CA
5,600	C430C562(1)5G5CA
6,800	C430C682(1)5G5CA
8,200	C430C822(1)5G5CA
10,000	C440C103(1)5G5CA
12,000	C440C123(1)5G5CA
15,000	C440C153(1)5G5CA

(1) Insert proper letter for capacitance tolerance desired:
 J = ±5%
 K = ±10%
 M = ±20%

18,000	C420C183(1)1R5CA
22,000	C420C223(1)1R5CA
27,000	C420C273(1)1R5CA
33,000	C420C333(1)1R5CA
39,000	C430C393(1)1R5CA
47,000	C430C473(1)1R5CA
56,000	C430C563(1)1R5CA
68,000	C430C683(1)1R5CA
82,000	C430C823(1)1R5CA
100,000	C430C104(1)1R5CA
120,000	C440C124(1)1R5CA
150,000	C440C154(1)1R5CA
50 VOLT - X7R	
8,200	C410C822(1)5R5CA
10,000	C410C103(1)5R5CA
12,000	C410C123(1)5R5CA
15,000	C410C153(1)5R5CA
18,000	C410C183(1)5R5CA
22,000	C410C223(1)5R5CA
27,000	C410C273(1)5R5CA
33,000	C410C333(1)5R5CA
39,000	C410C393(1)5R5CA
47,000	C410C473(1)5R5CA
56,000	C412C563(1)5R5CA
68,000	C412C683(1)5R5CA
82,000	C412C823(1)5R5CA
100,000	C412C104(1)5R5CA
56,000	C420C563(1)5R5CA
68,000	C420C683(1)5R5CA
82,000	C420C823(1)5R5CA
100,000	C420C104(1)5R5CA
120,000	C430C124(1)5R5CA
150,000	C430C154(1)5R5CA
180,000	C430C184(1)5R5CA
220,000	C430C224(1)5R5CA
270,000	C430C274(1)5R5CA
330,000	C440C334(1)5R5CA
390,000	C440C394(1)5R5CA
470,000	C440C474(1)5R5CA

(1) Insert proper letter for capacitance tolerance desired:
 K = ±10%, M = ±20%

56,000	C410C563(1)5U5CA
68,000	C410C683(1)5U5CA
82,000	C410C823(1)5U5CA
100,000	C410C104(1)5U5CA
120,000	C410C124(1)5U5CA
150,000	C410C154(1)5U5CA
180,000	C410C184(1)5U5CA
220,000	C410C224(1)5U5CA
270,000	C412C274(1)5U5CA
330,000	C412C334(1)5U5CA
270,000	C420C274(1)5U5CA
330,000	C420C334(1)5U5CA
390,000	C430C394(1)5U5CA
470,000	C430C474(1)5U5CA
560,000	C430C564(1)5U5CA
680,000	C430C684(1)5U5CA
820,000	C440C824(1)5U5CA
1,000,000	C440C105(1)5U5CA

(1) Insert proper letter for capacitance tolerance desired:
 M = ±20%, Z = +80, -20%

For packaging information, see pages 32 and 34.

KEMET Electronics Corporation, P.O. Box 5928, Greenville, S.C. 29606, (864) 963-6300

C323	.200 (5.08)	.320 (8.13)	.125 (3.18)	.200 (5.08)	.020 (.51)
C330	.300 (7.62)	.360 (9.14)	.150 (3.81)	.200 (5.08)	.020 (.51)
C333	.300 (7.62)	.390 (9.91)	.150 (3.81)	.200 (5.08)	.020 (.51)
C340	.400 (10.16)	.460 (11.68)	.150 (3.81)	.200 (5.08)	.020 (.51)
C350	.500 (12.70)	.560 (14.22)	.200 (5.08)	.400 (10.16)	.025 (.64)

NOTE: 1 inch = 25.4 mm.
 NOTE: (1) Measured at seating plane.

ORDERING INFORMATION

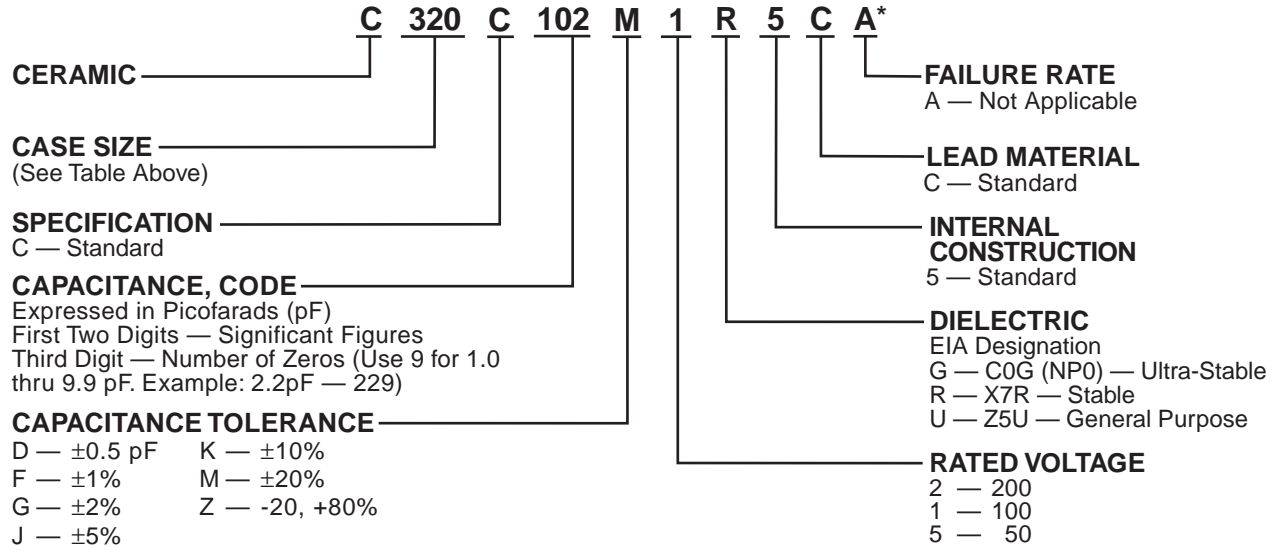

*Part Number Example: C320C102M1R5CA (14 digits – no spaces)

For packaging information, see pages 33 and 34.

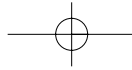

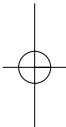

Lead Spacing
.200" ± .030

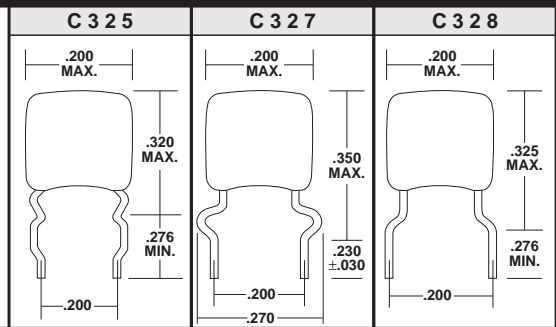

Lead Spacing
.200" ± .030

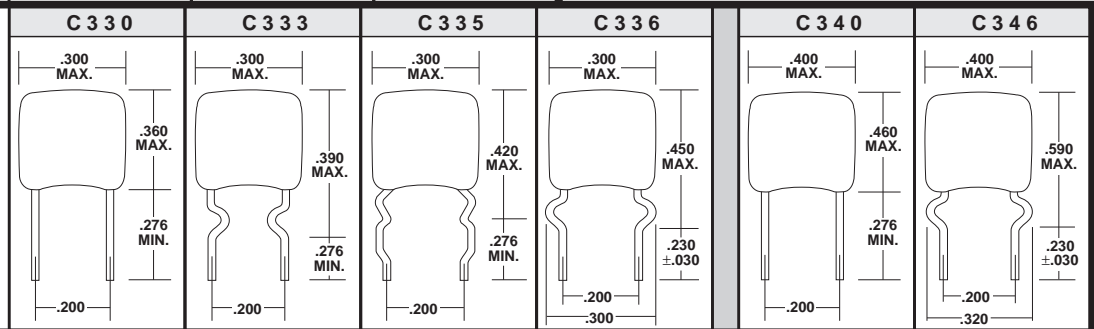

Lead Spacing
.250" ± .030

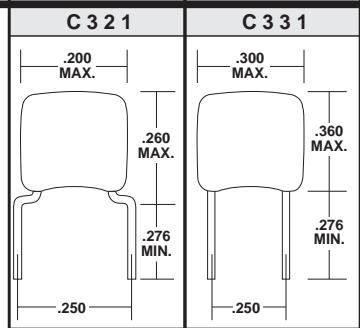

Lead Spacing
.400" ± .030

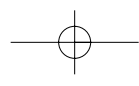
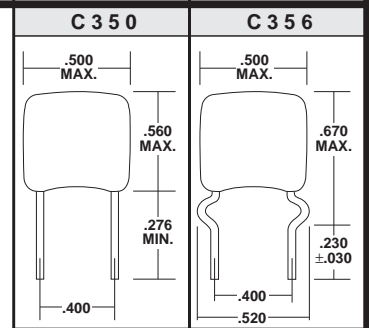

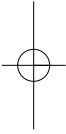

33 pF	C31(1)C330(3)2G5CA
39 pF	C31(1)C390(3)2G5CA
47 pF	C31(1)C470(3)2G5CA
56 pF	C31(1)C560(3)2G5CA
68 pF	C31(1)C680(3)2G5CA
82 pF	C31(1)C820(3)2G5CA
100 pF	C31(1)C101(3)2G5CA
120 pF	C31(1)C121(3)2G5CA
150 pF	C31(1)C151(3)2G5CA
180 pF	C31(1)C181(3)2G5CA
220 pF	C31(1)C221(3)2G5CA
270 pF	C31(1)C271(3)2G5CA
330 pF	C31(1)C331(3)2G5CA
390 pF	C31(1)C391(3)2G5CA
470 pF	C31(1)C471(3)2G5CA
200 VOLT – C32X SIZE	
1.0 pF	C32(2)C109(3)2G5CA
1.5 pF	C32(2)C159(3)2G5CA
2.2 pF	C32(2)C229(3)2G5CA
2.7 pF	C32(2)C279(3)2G5CA
3.3 pF	C32(2)C339(3)2G5CA
3.9 pF	C32(2)C399(3)2G5CA
4.7 pF	C32(2)C479(3)2G5CA
5.6 pF	C32(2)C569(3)2G5CA
6.8 pF	C32(2)C689(3)2G5CA
8.2 pF	C32(2)C829(3)2G5CA
10 pF	C32(2)C100(3)2G5CA
12 pF	C32(2)C120(3)2G5CA
15 pF	C32(2)C150(3)2G5CA
18 pF	C32(2)C180(3)2G5CA
22 pF	C32(2)C220(3)2G5CA
27 pF	C32(2)C270(3)2G5CA
33 pF	C32(2)C330(3)2G5CA
39 pF	C32(2)C390(3)2G5CA

1,000 pF	C32(2)C102(3)2G5CA
1,200 pF	C32(2)C122(3)2G5CA
1,500 pF	C32(2)C152(3)2G5CA
1,800 pF	C32(2)C182(3)2G5CA
2,200 pF	C32(2)C222(3)2G5CA
2,700 pF	C32(2)C272(3)2G5CA
3,300 pF	C32(2)C332(3)2G5CA
200 VOLT – C33X SIZE	
2,700 pF	C33(4)C272(3)2G5CA
3,300 pF	C33(4)C332(3)2G5CA
3,900 pF	C33(4)C392(3)2G5CA
4,700 pF	C33(4)C472(3)2G5CA
5,600 pF	C33(4)C562(3)2G5CA
6,800 pF	C33(4)C682(3)2G5CA
8,200 pF	C33(4)C822(3)2G5CA
.01 µF	C33(4)C103(3)2G5CA
.012 µF	C33(4)C123(3)2G5CA
.015 µF	C33(4)C153(3)2G5CA
.018 µF	C33(4)C183(3)2G5CA
200 VOLT – C340 SIZE	
.018 µF	C340C183(3)2G5CA
.022 µF	C340C223(3)2G5CA
.027 µF	C340C273(3)2G5CA
.033 µF	C340C333(3)2G5CA
.039 µF	C340C393(3)2G5CA
.047 µF	C340C473(3)2G5CA
200 VOLT – C350 SIZE	
.039 µF	C350C393(3)2G5CA
.047 µF	C350C473(3)2G5CA
.056 µF	C350C563(3)2G5CA
.068 µF	C350C683(3)2G5CA

1,000 pF	C32(2)C102(3)1G5CA
1,200 pF	C32(2)C122(3)1G5CA
1,500 pF	C32(2)C152(3)1G5CA
1,800 pF	C32(2)C182(3)1G5CA
2,200 pF	C32(2)C222(3)1G5CA
2,700 pF	C32(2)C272(3)1G5CA
3,300 pF	C32(2)C332(3)1G5CA
3,900 pF	C32(2)C392(3)1G5CA
4,700 pF	C32(2)C472(3)1G5CA
5,600 pF	C32(2)C562(3)1G5CA
100 VOLT – C33X SIZE	
3,300 pF	C33(4)C332(3)1G5CA
3,900 pF	C33(4)C392(3)1G5CA
4,700 pF	C33(4)C472(3)1G5CA
5,600 pF	C33(4)C562(3)1G5CA
6,800 pF	C33(4)C682(3)1G5CA
8,200 pF	C33(4)C822(3)1G5CA
.01 µF	C33(4)C103(3)1G5CA
.012 µF	C33(4)C123(3)1G5CA
.015 µF	C33(4)C153(3)1G5CA
.018 µF	C33(4)C183(3)1G5CA
.022 µF	C33(4)C223(3)1G5CA
.027 µF	C33(4)C273(3)1G5CA
100 VOLT – C340 SIZE	
.027 µF	C340C273(3)1G5CA
.033 µF	C340C333(3)1G5CA
.039 µF	C340C393(3)1G5CA
.047 µF	C340C473(3)1G5CA
.056 µF	C340C563(3)1G5CA
.068 µF	C340C683(3)1G5CA
100 VOLT – C350 SIZE	
.039 µF	C350C393(3)1G5CA
.047 µF	C350C473(3)1G5CA
.056 µF	C350C563(3)1G5CA
.068 µF	C350C683(3)1G5CA
.082 µF	C350C823(3)1G5CA
.1 µF	C350C104(3)1G5CA
.12 µF	C350C124(3)1G5CA

- NOTES:** (1) Case Sizes C315/C317 are identical electrically, but differ in lead spacing. See table of dimensions. Insert the appropriate symbol, "5" or "7" in the part number.
(2) Case Sizes C320/C322/C323 are identical electrically. See table of dimensions. Insert the appropriate symbol, "0" or "2" or "3" in the part number.
(3) Insert proper symbol for capacitance tolerance as follows:
1.0 pF – 8.2 pF: D – ± 0.5pF
10 pF – 22 pF: J – ±5%, K – ±10%
27 pF – 47 pF: G – ±2%, J – ±5%, K – ±10%
56 pF and up: F – ±1%, G – ±2%, J – ±5%
(4) Case Sizes C330 and C333 are identical electrically. Insert the appropriate symbol "0" or "3" in the part number.

10 KEMET Electronics Corporation, P.O. Box 5928, Greenville, S.C. 29606, (864) 963-6300

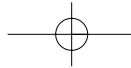

4,700 pF	C32(2)C472(3)2R5CA
5,600 pF	C32(2)C562(3)2R5CA
6,800 pF	C32(2)C682(3)2R5CA
8,200 pF	C32(2)C822(3)2R5CA
.01 µF	C32(2)C103(3)2R5CA
.012 µF	C32(2)C123(3)2R5CA
.015 µF	C32(2)C153(3)2R5CA
.018 µF	C32(2)C183(3)2R5CA
.022 µF	C32(2)C223(3)2R5CA
200 VOLT – C33X SIZE	
.015 µF	C33(4)C153(3)2R5CA
.018 µF	C33(4)C183(3)2R5CA
.022 µF	C33(4)C223(3)2R5CA
.027 µF	C33(4)C273(3)2R5CA
.033 µF	C33(4)C333(3)2R5CA
.039 µF	C33(4)C393(3)2R5CA
.047 µF	C33(4)C473(3)2R5CA
.056 µF	C33(4)C563(3)2R5CA
.068 µF	C33(4)C683(3)2R5CA
.082 µF	C33(4)C823(3)2R5CA
.1 µF	C33(4)C104(3)2R5CA
200 VOLT – C340 SIZE	
.1 µF	C340C104(3)2R5CA
.12 µF	C340C124(3)2R5CA
.15 µF	C340C154(3)2R5CA
.18 µF	C340C184(3)2R5CA
.22 µF	C340C224(3)2R5CA
.27 µF	C340C274(3)2R5CA
200 VOLT – C350 SIZE	
.22 µF	C350C224(3)2R5CA
.27 µF	C350C274(3)2R5CA
.33 µF	C350C334(3)2R5CA
.39 µF	C350C394(3)2R5CA
.47 µF	C350C474(3)2R5CA

.039 µF	C32(2)C393(3)1R5CA
.047 µF	C32(2)C473(3)1R5CA
.056 µF	C32(2)C563(3)1R5CA
.068 µF	C32(2)C683(3)1R5CA
.082 µF	C32(2)C823(3)1R5CA
.1 µF	C32(2)C104(3)1R5CA
100 VOLT – C33X SIZE	
.068 µF	C33(4)C683(3)1R5CA
.082 µF	C33(4)C823(3)1R5CA
.1 µF	C33(4)C104(3)1R5CA
.12 µF	C33(4)C124(3)1R5CA
.15 µF	C33(4)C154(3)1R5CA
.18 µF	C33(4)C184(3)1R5CA
.22 µF	C33(4)C224(3)1R5CA
.27 µF	C33(4)C274(3)1R5CA
.33 µF	C33(4)C334(3)1R5CA
.39 µF	C33(4)C394(3)1R5CA
.47 µF	C33(4)C474(3)1R5CA
100 VOLT – C340 SIZE	
.47 µF	C340C474(3)1R5CA
.56 µF	C340C564(3)1R5CA
.68 µF	C340C684(3)1R5CA
.82 µF	C340C824(3)1R5CA
1.0 µF	C340C105(3)1R5CA
100 VOLT – C350 SIZE	
.68 µF	C350C684(3)1R5CA
.82 µF	C350C824(3)1R5CA
1.0 µF	C350C105(3)1R5CA
1.2 µF	C350C125(3)1R5CA

.12 µF	C32(2)C124(3)5R5CA
.15 µF	C32(2)C154(3)5R5CA
.18 µF	C32(2)C184(3)5R5CA
.22 µF	C32(2)C224(3)5R5CA
.27 µF	C32(2)C274(3)5R5CA
50 VOLT – C33X SIZE	
.15 µF	C33(4)C154(3)5R5CA
.18 µF	C33(4)C184(3)5R5CA
.22 µF	C33(4)C224(3)5R5CA
.27 µF	C33(4)C274(3)5R5CA
.33 µF	C33(4)C334(3)5R5CA
.39 µF	C33(4)C394(3)5R5CA
.47 µF	C33(4)C474(3)5R5CA
.56 µF	C33(4)C564(3)5R5CA
.68 µF	C33(4)C684(3)5R5CA
.82 µF	C33(4)C824(3)5R5CA
1.0 µF	C33(4)C105(3)5R5CA
50 VOLT – C340 SIZE	
1.2 µF	C340C125(3)5R5CA
1.5 µF	C340C155(3)5R5CA
1.8 µF	C340C185(3)5R5CA
2.2 µF	C340C225(3)5R5CA
50 VOLT – C350 SIZE	
2.2 µF	C350C225(3)5R5CA
2.7 µF	C350C275(3)5R5CA
3.3 µF	C350C335(3)5R5CA
3.9 µF	C350C395(3)5R5CA
4.7 µF	C350C475(3)5R5CA

NOTES: (1) Case Sizes C315/C317 are identical electrically, but differ in lead spacing. See table of dimensions. Insert the appropriate symbol, "5" or "7" in the part number.
(2) Case Sizes C320/C322/C323 are identical electrically. See table of dimensions. Insert the appropriate symbol, "0" or "2" or "3" in the part number.
(3) Insert proper symbol for capacitance tolerance as follows: K – ±10%, M – ±20%
(4) Case Sizes C330 and C333 are identical electrically. Insert the appropriate symbol "0" or "3" in the part number.

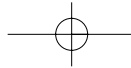

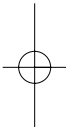

.047 μ F	C32(2)C473(3)1U5CA
.056 μ F	C32(2)C563(3)1U5CA
.068 μ F	C32(2)C683(3)1U5CA
.082 μ F	C32(2)C823(3)1U5CA
0.1 μ F	C32(2)C104(3)1U5CA
.12 μ F	C32(2)C124(3)1U5CA
.15 μ F	C32(2)C154(3)1U5CA
100 VOLT – C33X SIZE	
0.1 μ F	C33(4)C104(3)1U5CA
.12 μ F	C33(4)C124(3)1U5CA
.15 μ F	C33(4)C154(3)1U5CA
.18 μ F	C33(4)C184(3)1U5CA
.22 μ F	C33(4)C224(3)1U5CA
.27 μ F	C33(4)C274(3)1U5CA
.33 μ F	C33(4)C334(3)1U5CA
.39 μ F	C33(4)C394(3)1U5CA
.47 μ F	C33(4)C474(3)1U5CA
100 VOLT – C340 SIZE	
.47 μ F	C340C474(3)1U5CA
.56 μ F	C340C564(3)1U5CA
.68 μ F	C340C684(3)1U5CA
.82 μ F	C340C824(3)1U5CA
1.0 μ F	C340C105(3)1U5CA
1.2 μ F	C340C125(3)1U5CA
1.5 μ F	C340C155(3)1U5CA
100 VOLT – C350 SIZE	
1.0 μ F	C350C105(3)1U5CA
1.2 μ F	C350C125(3)1U5CA
1.5 μ F	C350C155(3)1U5CA
1.8 μ F	C350C185(3)1U5CA
2.2 μ F	C350C225(3)1U5CA

0.1 μ F	C32(2)C104(3)5U5CA
.12 μ F	C32(2)C124(3)5U5CA
.15 μ F	C32(2)C154(3)5U5CA
.18 μ F	C32(2)C184(3)5U5CA
.22 μ F	C32(2)C224(3)5U5CA
.27 μ F	C32(2)C274(3)5U5CA
.33 μ F	C32(2)C334(3)5U5CA
.39 μ F	C32(2)C394(3)5U5CA
.47 μ F	C32(2)C474(3)5U5CA
.56 μ F	C32(2)C564(3)5U5CA
50 VOLT – C33X SIZE	
.27 μ F	C33(4)C274(3)5U5CA
.33 μ F	C33(4)C334(3)5U5CA
.39 μ F	C33(4)C394(3)5U5CA
.47 μ F	C33(4)C474(3)5U5CA
.56 μ F	C33(4)C564(3)5U5CA
.68 μ F	C33(4)C684(3)5U5CA
.82 μ F	C33(4)C824(3)5U5CA
1.0 μ F	C33(4)C105(3)5U5CA
1.2 μ F	C33(4)C125(3)5U5CA
1.5 μ F	C33(4)C155(3)5U5CA
1.8 μ F	C33(4)C185(3)5U5CA
2.2 μ F	C33(4)C225(3)5U5CA
50 VOLT – C340 SIZE	
2.2 μ F	C340C225(3)5U5CA
2.7 μ F	C340C275(3)5U5CA
3.3 μ F	C340C335(3)5U5CA
3.9 μ F	C340C395(3)5U5CA
4.7 μ F	C340C475(3)5U5CA
50 VOLT – C350 SIZE	
3.9 μ F	C350C395(3)5U5CA
4.7 μ F	C350C475(3)5U5CA
5.6 μ F	C350C565(3)5U5CA
6.8 μ F	C350C685(3)5U5CA

- NOTES:** (1) Case Sizes C315/C317 are identical electrically, but differ in lead spacing. See table of dimensions. Insert the appropriate symbol, "5" or "7" in the part number.
- (2) Case Sizes C320/C322/C323 are identical electrically. See table of dimensions. Insert the appropriate symbol, "0" or "2" or "3" in the part number.
- (3) Insert proper symbol for capacitance tolerance as follows:
 M – $\pm 20\%$
 Z – $+80\%$, -20%
- (4) Case Sizes C330 and C333 are identical electrically. Insert the appropriate symbol "0" or "3" in the part number.

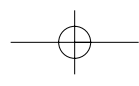

at 1 kHz (1000 pF or less at 1 MHz for C0G).

Dissipation Factor:

25°C at 1 kHz (1000 pF or less at 1 MHz for C0G).

C0G – .15% maximum

X7R – 2.5% maximum

Insulation Resistance:

After 2 minutes electrification at 25°C and rated voltage

C0G – 100K megohms or 1000 megohm - μ F, whichever is less.

X7R – 100K megohms or 1000 megohm - μ F, whichever is less.

Dielectric Withstanding Voltage:

250% of rated voltage for 5 seconds with current limited to 50 mA at 25°C.

Life Test:

2000 hours at 200% of rated voltage at 125°C. Post-Test limits at 25°C are:

Capacitance Change:

C0G – less than 3% or 0.25 pF, whichever is higher

X7R – \pm 20% of initial value

Dissipation Factor:

C0G – .25% maximum

X7R – 3.0% maximum

Insulation Resistance:

C0G – 10K megohms or 100 megohm - μ F, whichever is less

X7R – 10K megohms or 100 megohm - μ F, whichever is less

Solderability:

MIL-STD-202, Method 208, Sn62 solder, 245°C for 5 \pm 1/2 seconds.

Resistance to Soldering Heat:

MIL-STD-202, Method 210, Condition B (260°C, 10 secs).

Depth of immersion – to a minimum of .050" from the capacitor body.

Lead Material:

Axial: Solder-coated copper clad steel

Radial: Solder-coated copper

CAPACITOR OUTLINE DRAWINGS – (RADIAL LEADS)

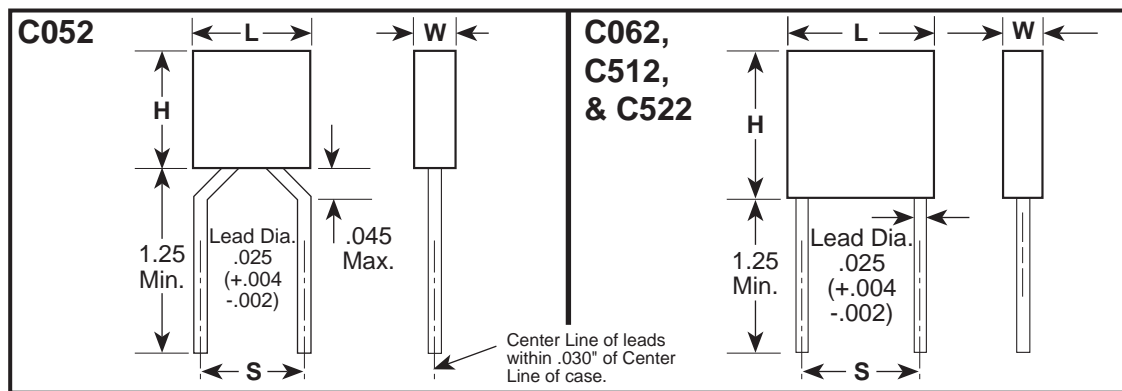

DIMENSIONS—INCHES & (MILLIMETERS)

CASE SIZE	MILITARY EQUIVALENT STYLES	H HEIGHT	L LENGTH	W WIDTH	S LEAD SPACING
C052	CC05, CCR05 CK05, CKR05	.190 ± .010 (4.83 ± .25)	.190 ± .010 (4.83 ± .25)	.090 ± .010 (2.29 ± .25)	.200 ± .015 (5.08 ± .38)
C062	CC06, CCR06 CK06, CKR06	.290 ± .010 (7.37 ± .25)	.290 ± .010 (7.37 ± .25)	.090 ± .010 (2.29 ± .25)	.200 ± .015 (5.08 ± .38)
C512	CC07, CCR07	.480 ± .020 (12.19 ± .51)	.480 ± .020 (12.19 ± .51)	.140 ± .010 (3.56 ± .25)	.400 ± .020 (10.16 ± .51)
C522	CC08, CCR08	.480 ± .020 (12.19 ± .51)	.480 ± .020 (12.19 ± .51)	.240 ± .010 (6.10 ± .25)	.400 ± .020 (10.16 ± .51)

For packaging information, see pages 32, 33 and 34.

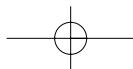

*CASE SIZES	
RADIAL	AXIAL
C052	C114
C062	C124
C512	C192
C522	C202
	C222

R (Stable)	X7R	-55 to +125	±15%
---------------	-----	----------------	------

****Part Number Example: C052C102K2R5CA (14 digits – no spaces)**

AXIAL CAPACITOR MARKINGS STANDARD C114C, C124C, C192C, C202C & C222C

KC0G	—	KEMET, Temperature Characteristic
101J	—	Capacitance, Capacitance Tolerance
200V	—	Voltage
0012	—	Date Code

RADIAL CAPACITOR MARKINGS C052C & C062C STANDARD MARKING

	FRONT	BACK	
Style	C062	100V	Voltage
Temperature Characteristic	X7R	K	KEMET
Capacitance, Capacitance Tolerance	104K	0011	Date Code

C512 & C522 STANDARD MARKING

KEMET	—	KEMET
C512X7R	—	SIZE and Temperature Characteristic
105K 50V	—	Capacitance, Capacitance Tolerance, Voltage
0032	—	Date Code

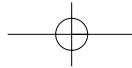

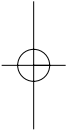

220.0	C114C221(4)1G5CA
270.0	C114C271(4)2G5CA
330.0	C114C331(4)2G5CA
100 VOLT – C114 STANDARD COG	
82.0	C114C820(4)1G5CA
100.0	C114C101(4)1G5CA
120.0	C114C121(4)1G5CA
150.0	C114C151(4)1G5CA
180.0	C114C181(4)1G5CA
220.0	C114C221(4)1G5CA
270.0	C114C271(4)1G5CA
330.0	C114C331(4)1G5CA
390.0	C114C391(4)1G5CA
470.0	C114C471(4)1G5CA
560.0	C114C561(4)1G5CA
680.0	C114C681(4)1G5CA

3,900.0	C192C392(4)1G5CA
4,700.0	C192C472(4)1G5CA
5,600.0	C192C562(4)1G5CA
6,800.0	C192C682(4)1G5CA
8,200.0	C192C822(4)1G5CA

82,000.0	C222C823(4)1G5CA
100,000.0	C222C104(4)1G5CA

NOTE 1: Insert proper symbol for capacitance tolerance as follows:

- (1) 1.0 pF to 8.2 pF: D- ±5 pF
- (2) 10.0 pF to 22 pF: J- ±5%, K- ±10%
- (3) 27.0 pF to 47 pF: G- ±2%, J- ±5%, K- ±10%
- (4) 56.0 pF and up: F- ±1%, G- ±2%, J- ±5%, K- ±10%

NOTE 1: Insert proper symbol for capacitance tolerance as follows:

- (1) 1.0 pF to 8.2 pF: D- ±5 pF
- (2) 10.0 pF to 22 pF: J- ±5%, K- ±10%
- (3) 27.0 pF to 47 pF: G- ±2%, J- ±5%, K- ±10%
- (4) 56.0 pF and up: F- ±1%, G- ±2%, J- ±5%, K- ±10%

NOTE 1: Insert proper symbol for capacitance tolerance as follows:

- (1) 1.0 pF to 8.2 pF: D- ±5 pF
- (2) 10.0 pF to 22 pF: J- ±5%, K- ±10%
- (3) 27.0 pF to 47 pF: G- ±2%, J- ±5%, K- ±10%
- (4) 56.0 pF and up: F- ±1%, G- ±2%, J- ±5%, K- ±10%

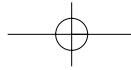

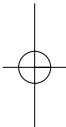

220.0	C052C221(4)2G5CA
270.0	C052C271(4)2G5CA
330.0	C052C331(4)2G5CA
390.0	C052C391(4)2G5CA
470.0	C052C471(4)2G5CA
560.0	C052C561(4)2G5CA
680.0	C052C681(4)2G5CA
820.0	C052C821(4)2G5CA
1,000.0	C052C102(4)2G5CA
1,200.0	C052C122(4)2G5CA
1,500.0	C052C152(4)2G5CA
1,800.0	C052C182(4)2G5CA
2,200.0	C052C222(4)2G5CA
2,700.0	C052C272(4)2G5CA
100 VOLT — C052 SIZE C0G	
390.0	C052C391(4)1G5CA
470.0	C052C471(4)1G5CA
560.0	C052C561(4)1G5CA
680.0	C052C681(4)1G5CA
820.0	C052C821(4)1G5CA
1,000.0	C052C102(4)1G5CA
1,200.0	C052C122(4)1G5CA
1,500.0	C052C152(4)1G5CA
1,800.0	C052C182(4)1G5CA
2,200.0	C052C222(4)1G5CA
2,700.0	C052C272(4)1G5CA
3,300.0	C052C332(4)1G5CA
3,900.0	C052C392(4)1G5CA
4,700.0	C052C472(4)1G5CA

NOTE 1: Insert proper symbol for capacitance tolerance as follows:

- (1) 1.0 pF to 8.2 pF: D— ±5 pF
- (2) 10.0 pF to 22 pF: J— ±5%, K— ±10%
- (3) 27.0 pF to 47 pF: G— ±2%, J— ±5%, K— ±10%
- (4) 56.0 pF and up: F— ±1%, G— ±2%, J— ±5%, K— ±10%

68,000.0	C512C683(4)2G5CA
100 VOLT — C512 SIZE C0G	
27,000.0	C512C273(4)1G5CA
33,000.0	C512C333(4)1G5CA
39,000.0	C512C393(4)1G5CA
47,000.0	C512C473(4)1G5CA
56,000.0	C512C563(4)1G5CA
68,000.0	C512C683(4)1G5CA
82,000.0	C512C823(4)1G5CA
100,000.0	C512C104(4)1G5CA
200 VOLT — C522 SIZE C0G	
82,000.0	C522C823(4)2G5CA
100,000.0	C522C104(4)2G5CA
100 VOLT — C522 SIZE C0G	
120,000.0	C522C124(4)1G5CA
150,000.0	C522C154(4)1G5CA
180,000.0	C522C184(4)1G5CA

NOTE 1: Insert proper symbol for capacitance tolerance as follows:

- (1) 1.0 pF to 8.2 pF: D— ±5 pF
- (2) 10.0 pF to 22 pF: J— ±5%, K— ±10%
- (3) 27.0 pF to 47 pF: G— ±2%, J— ±5%, K— ±10%
- (4) 56.0 pF and up: F— ±1%, G— ±2%, J— ±5%, K— ±10%

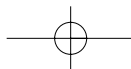

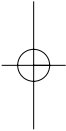

270	10	C114C271K1R5CA
330	10	C114C331K1R5CA
330	20	C114C331M1R5CA
390	10	C114C391K1R5CA
470	10	C114C471K1R5CA
470	20	C114C471M1R5CA
560	10	C114C561K1R5CA
680	10	C114C681K1R5CA
680	20	C114C681M1R5CA
820	10	C114C821K1R5CA
1,000	10	C114C102K1R5CA
1,000	20	C114C102M1R5CA
1,200	10	C114C122K1R5CA
1,500	10	C114C152K1R5CA
1,500	20	C114C152M1R5CA
1,800	10	C114C182K1R5CA
2,200	10	C114C222K1R5CA
2,200	20	C114C222M1R5CA
2,700	10	C114C272K1R5CA
3,300	10	C114C332K1R5CA
3,300	20	C114C332M1R5CA
3,900	10	C114C392K1R5CA
4,700	10	C114C472K1R5CA
4,700	20	C114C472M1R5CA
50 VOLT – C114 SIZE		
5,600	10	C114C562K5R5CA
6,800	10	C114C682K5R5CA
6,800	20	C114C682M5R5CA
8,200	10	C114C822K5R5CA
10,000	10	C114C103K5R5CA
10,000	20	C114C103M5R5CA

22,000	20	C192C223M1R5CA
27,000	10	C192C273K1R5CA
33,000	10	C192C333K1R5CA
33,000	20	C192C333M1R5CA
39,000	10	C192C393K1R5CA
47,000	10	C192C473K1R5CA
47,000	20	C192C473M1R5CA
56,000	10	C192C563K1R5CA
68,000	10	C192C683K1R5CA
68,000	20	C192C683M1R5CA
82,000	10	C192C823K1R5CA
100,000	10	C192C104K1R5CA
100,000	20	C192C104M1R5CA
50 VOLT – C192 SIZE		
56,000	10	C192C563K5R5CA
68,000	10	C192C683K5R5CA
68,000	20	C192C683M5R5CA
82,000	10	C192C823K5R5CA
100,000	10	C192C104K5R5CA
100,000	20	C192C104M5R5CA
120,000	10	C192C124K5R5CA
150,000	10	C192C154K5R5CA
150,000	20	C192C154M5R5CA
180,000	10	C192C184K5R5CA
220,000	10	C192C224K5R5CA
220,000	20	C192C224M5R5CA
270,000	10	C192C274K5R5CA

680,000	10	C222C684K1R5CA
680,000	20	C222C684M1R5CA
1,000,000	10	C222C105K1R5CA
1,000,000	20	C222C105M1R5CA
50 VOLT – C222 SIZE		
2,200,000	10	C222C225K5R5CA
2,200,000	20	C222C225M5R5CA
3,300,000	10	C222C335K5R5CA
3,300,000	20	C222C335M5R5CA

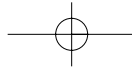

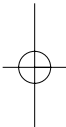

270	10	C052C271K2R5CA
330	10	C052C331K2R5CA
330	20	C052C331M2R5CA
390	10	C052C391K2R5CA
470	10	C052C471K2R5CA
470	20	C052C471M2R5CA
560	10	C052C561K2R5CA
680	10	C052C681K2R5CA
680	20	C052C681M2R5CA
820	10	C052C821K2R5CA
1,000	10	C052C102K2R5CA
1,000	20	C052C102M2R5CA

33,000	10	C052C333K5R5CA
33,000	20	C052C333M5R5CA
39,000	10	C052C393K5R5CA
47,000	10	C052C473K5R5CA
47,000	20	C052C473M5R5CA
56,000	10	C052C563K5R5CA
68,000	10	C052C683K5R5CA
68,000	20	C052C683M5R5CA
82,000	10	C052C823K5R5CA
100,000	10	C052C104K5R5CA
100,000	20	C052C104M5R5CA

330,000	10	C062C334K5R5CA
330,000	20	C062C334M5R5CA
390,000	10	C062C394K5R5CA
470,000	10	C062C474K5R5CA
470,000	20	C062C474M5R5CA
560,000	10	C062C564K5R5CA
680,000	10	C062C684K5R5CA
680,000	20	C062C684M5R5CA
820,000	10	C062C824K5R5CA
1,000,000	10	C062C105K5R5CA
1,000,000	20	C062C105M5R5CA

200 VOLT – C062 SIZE		
1,200	10	C062C122K2R5CA
1,500	10	C062C152K2R5CA
1,500	20	C062C152M2R5CA
1,800	10	C062C182K2R5CA
2,200	10	C062C222K2R5CA
2,200	20	C062C222M2R5CA
2,700	10	C062C272K2R5CA
3,300	10	C062C332K2R5CA
3,300	20	C062C332M2R5CA
3,900	10	C062C392K2R5CA
4,700	10	C062C472K2R5CA
4,700	20	C062C472M2R5CA
5,600	10	C062C562K2R5CA
6,800	10	C062C682K2R5CA
6,800	20	C062C682M2R5CA
8,200	10	C062C822K2R5CA
10,000	10	C062C103K2R5CA
10,000	20	C062C103M2R5CA

50 VOLT – C512 SIZE		
1,000,000	10	C512C105K5X5CA
1,000,000	20	C512C105M5X5CA
1,500,000	10	C512C155K5X5CA
1,500,000	20	C512C155M5X5CA
2,000,000	10	C512C205K5X5CA
2,000,000	20	C512C205M5X5CA
2,200,000	10	C512C225K5X5CA
2,200,000	20	C512C225M5X5CA
100 VOLT – C522 SIZE		
1,000,000	10	C522C105K1X5CA
1,000,000	20	C522C105M1X5CA
50 VOLT – C522 SIZE		
2,700,000	10	C522C275K5X5CA
2,700,000	20	C522C275M5X5CA
3,300,000	10	C522C335K5X5CA
3,300,000	20	C522C335M5X5CA

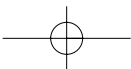

CAPACITOR OUTLINE DRAWINGS (RADIAL LEADS)

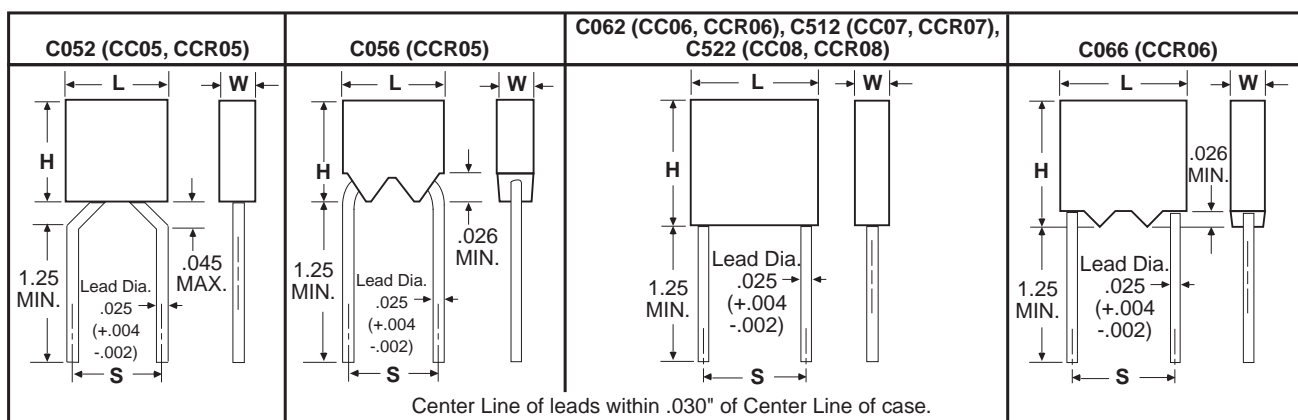

* Leads are .625 minimum when tape and reel packaged

DIMENSIONS – INCHES & (MILLIMETERS)

CASE SIZE	MILITARY EQUIVALENT STYLES	H HEIGHT	L LENGTH	W WIDTH	S LEAD SPACING
C052/ C056	CC05, CCR05	.190 ± .010 (4.83 ± .25)	.190 ± .010 (4.83 ± .25)	.090 ± .010 (2.29 ± .25)	.200 ± .015 (5.08 ± .38)
C062/ C066	CC06, CCR06	.290 ± .010 (7.37 ± .25)	.290 ± .010 (7.37 ± .25)	.090 ± .010 (2.29 ± .25)	.200 ± .015 (5.08 ± .38)
C512	CC07, CCR07	.480 ± .020 (12.19 ± .51)	.480 ± .020 (12.19 ± .51)	.140 ± .010 (3.56 ± .25)*	.400 ± .020 (10.16 ± .51)
C522	CC08, CCR08	.480 ± .020 (12.19 ± .51)	.480 ± .020 (12.19 ± .51)	.240 ± .010 (6.10 ± .25)	.400 ± .020 (10.16 ± .51)

* 0.200 (5.08) maximum for 100,000 pF only.

For packaging information, see pages 32, 33 and 34.

RADIAL	AXIAL
C052	C114
C056	C124
C062	C192
C066	C202
C512	C222
C522	

*CH — ±60 ppm/°C 8.2 pF-18.0 pF.
 *CJ — ±120 ppm/°C 4.3 pF-7.5 pF.
 *CK — ±250 ppm/°C 2.2 pF-3.9 pF
 *CX — not measurable 0.1 pF-2.0 pF.

****Part Number Example: C052G102J1G5CR (14 digits – no spaces)**

CAPACITOR MARKINGS

CC(R) 75, 76

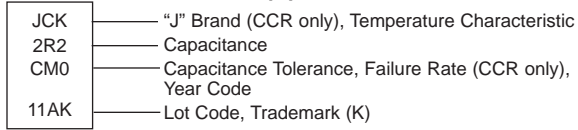

CC(R) 77

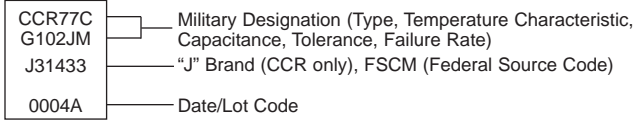

CC(R) 78

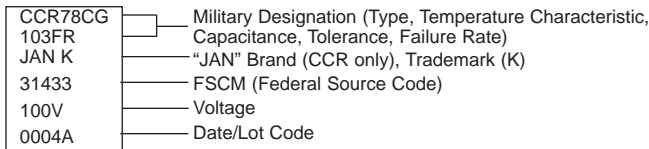

CC(R) 79

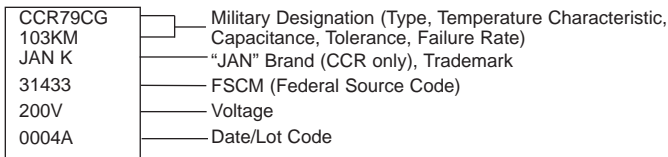

CC(R) 05

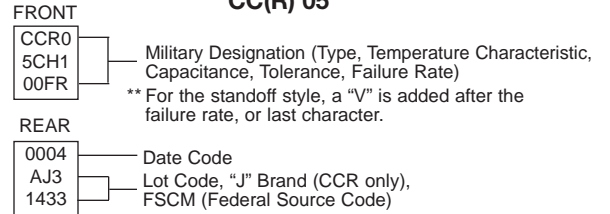

CC(R) 06

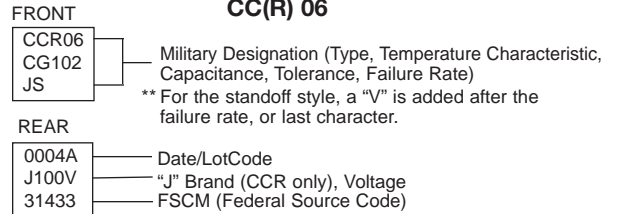

CC(R) 07

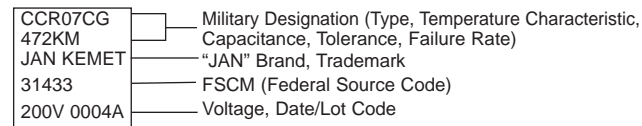

CC(R) 08

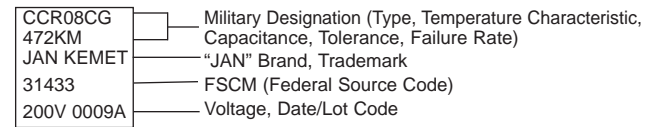

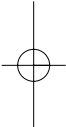

13.0	C114G130(4)2G5C(1)	CC75CH130(4)	CCR75CH130(4)(1)
15.0	C114G150(4)2G5C(1)	CC75CH150(4)	CCR75CH150(4)(1)
16.0	C114G160(4)2G5C(1)	CC75CH160(4)	CCR75CH160(4)(1)
18.0	C114G180(4)2G5C(1)	CC75CH180(4)	CCR75CH180(4)(1)
20.0	C114G200(4)2G5C(1)	CC75CG200(4)	CCR75CG200(4)(1)
22.0	C114G220(4)2G5C(1)	CC75CG220(4)	CCR75CG220(4)(1)
24.0	C114G240(4)2G5C(1)	CC75CG240(4)	CCR75CG240(4)(1)
27.0	C114G270(4)2G5C(1)	CC75CG270(4)	CCR75CG270(4)(1)
30.0	C114G300(4)2G5C(1)	CC75CG300(4)	CCR75CG300(4)(1)
33.0	C114G330(4)2G5C(1)	CC75CG330(4)	CCR75CG330(4)(1)
36.0	C114G360(4)2G5C(1)	CC75CG360(4)	CCR75CG360(4)(1)
39.0	C114G390(4)2G5C(1)	CC75CG390(4)	CCR75CG390(4)(1)
43.0	C114G430(4)2G5C(1)	CC75CG430(4)	CCR75CG430(4)(1)
47.0	C114G470(4)2G5C(1)	CC75CG470(4)	CCR75CG470(4)(1)
51.0	C114G510(4)2G5C(1)	CC75CG510(4)	CCR75CG510(4)(1)
56.0	C114G560(4)2G5C(1)	CC75CG560(4)	CCR75CG560(4)(1)
62.0	C114G620(4)2G5C(1)	CC75CG620(4)	CCR75CG620(4)(1)
68.0	C114G680(4)2G5C(1)	CC75CG680(4)	CCR75CG680(4)(1)
75.0	C114G750(4)2G5C(1)	CC75CG750(4)	CCR75CG750(4)(1)

To complete Part Number, insert the following letters:
(1) Available Failure Rates: A (CC styles only); M, P, R & S (CCR styles only).
(2) Available Capacitance Tolerances: B, C.
(3) Available Capacitance Tolerances: B, C, D.
(4) Available Capacitance Tolerances: F, G, J.

91.0	C124G910(4)2G5C(1)	CC76CG910(4)	CCR76CG910(4)(1)
100.0	C124G101(4)2G5C(1)	CC76CG101(4)	CCR76CG101(4)(1)
110.0	C124G111(4)2G5C(1)	CC76CG111(4)	CCR76CG111(4)(1)
120.0	C124G121(4)2G5C(1)	CC76CG121(4)	CCR76CG121(4)(1)
130.0	C124G131(4)2G5C(1)	CC76CG131(4)	CCR76CG131(4)(1)
100 VOLT — C124 (CC(R)76 PER MIL-PRF-20/28)			
270.0	C124G271(4)1G5C(1)	CC76CG271(4)	CCR76CG271(4)(1)
300.0	C124G301(4)1G5C(1)	CC76CG301(4)	CCR76CG301(4)(1)
330.0	C124G331(4)1G5C(1)	CC76CG331(4)	CCR76CG331(4)(1)
360.0	C124G361(4)1G5C(1)	CC76CG361(4)	CCR76CG361(4)(1)
390.0	C124G391(4)1G5C(1)	CC76CG391(4)	CCR76CG391(4)(1)
430.0	C124G431(4)1G5C(1)	CC76CG431(4)	CCR76CG431(4)(1)
470.0	C124G471(4)1G5C(1)	CC76CG471(4)	CCR76CG471(4)(1)
510.0	C124G511(4)1G5C(1)	CC76CG511(4)	CCR76CG511(4)(1)
560.0	C124G561(4)1G5C(1)	CC76CG561(4)	CCR76CG561(4)(1)
620.0	C124G621(4)1G5C(1)	CC76CG621(4)	CCR76CG621(4)(1)
680.0	C124G681(4)1G5C(1)	CC76CG681(4)	CCR76CG681(4)(1)

50 VOLT — C124 (CC(R)76 PER MIL-PRF-20/28)			
750.0	C124G751(4)5G5C(1)	CC76CG751(4)	CCR76CG751(4)(1)
820.0	C124G821(4)5G5C(1)	CC76CG821(4)	CCR76CG821(4)(1)
910.0	C124G911(4)5G5C(1)	CC76CG911(4)	CCR76CG911(4)(1)
1,000.0	C124G102(4)5G5C(1)	CC76CG102(4)	CCR76CG102(4)(1)

200 VOLT — C192 (CC(R)77 PER MIL-PRF-20/29)			
150.0	C192G151(4)2G5C(1)	CC77CG151(4)	CCR77CG151(4)(1)
160.0	C192G161(4)2G5C(1)	CC77CG161(4)	CCR77CG161(4)(1)
180.0	C192G181(4)2G5C(1)	CC77CG181(4)	CCR77CG181(4)(1)
200.0	C192G201(4)2G5C(1)	CC77CG201(4)	CCR77CG201(4)(1)
220.0	C192G221(4)2G5C(1)	CC77CG221(4)	CCR77CG221(4)(1)
240.0	C192G241(4)2G5C(1)	CC77CG241(4)	CCR77CG241(4)(1)
270.0	C192G271(4)2G5C(1)	CC77CG271(4)	CCR77CG271(4)(1)
300.0	C192G301(4)2G5C(1)	CC77CG301(4)	CCR77CG301(4)(1)
330.0	C192G331(4)2G5C(1)	CC77CG331(4)	CCR77CG331(4)(1)
360.0	C192G361(4)2G5C(1)	CC77CG361(4)	CCR77CG361(4)(1)
390.0	C192G391(4)2G5C(1)	CC77CG391(4)	CCR77CG391(4)(1)
430.0	C192G431(4)2G5C(1)	CC77CG431(4)	CCR77CG431(4)(1)
470.0	C192G471(4)2G5C(1)	CC77CG471(4)	CCR77CG471(4)(1)
510.0	C192G511(4)2G5C(1)	CC77CG511(4)	CCR77CG511(4)(1)
560.0	C192G561(4)2G5C(1)	CC77CG561(4)	CCR77CG561(4)(1)
620.0	C192G621(4)2G5C(1)	CC77CG621(4)	CCR77CG621(4)(1)
680.0	C192G681(4)2G5C(1)	CC77CG681(4)	CCR77CG681(4)(1)

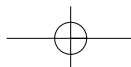

1,200.0	C202G122(5)2G5C(1)	CC78CG122(5)	CCR78CG122(5)(1)
1,500.0	C202G152(5)2G5C(1)	CC78CG152(5)	CCR78CG152(5)(1)
1,800.0	C202G182(5)2G5C(1)	CC78CG182(5)	CCR78CG182(5)(1)
2,200.0	C202G222(5)2G5C(1)	CC78CG222(5)	CCR78CG222(5)(1)
2,700.0	C202G272(5)2G5C(1)	CC78CG272(5)	CCR78CG272(5)(1)
3,300.0	C202G332(5)2G5C(1)	CC78CG332(5)	CCR78CG332(5)(1)

50 VOLT — C222 (CC(R)79 PER MIL-PRF-20/31)			
47,000.0	C222G473(5)5G5C(1)	CC79CG473(5)	CCR79CG473(5)(1)
56,000.0	C222G563(5)5G5C(1)	CC79CG563(5)	CCR79CG563(5)(1)
68,000.0	C222G683(5)5G5C(1)	CC79CG683(5)	CCR79CG683(5)(1)
82,000.0	C222G823(5)5G5C(1)	CC79CG823(5)	CCR79CG823(5)(1)

- To complete Part Number, insert the following letters:
- (1) Available Failure Rates: A (CC styles only); M, P, R & S (CCR styles only).
 - (2) Available Capacitance Tolerances: B, C.
 - (3) Available Capacitance Tolerances: B, C, D.
 - (4) Available Capacitance Tolerances: F, G, J.
 - (5) Available Capacitance Tolerances: F, G, J, K.

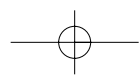
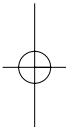

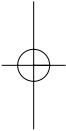

13.0	C05(6)G130(4)2G5C(1)	CC05CH130(4)	CCR05CH130(4)(1)(Z)
15.0	C05(6)G150(4)2G5C(1)	CC05CH150(4)	CCR05CH150(4)(1)(Z)
16.0	C05(6)G160(4)2G5C(1)	CC05CH160(4)	CCR05CH160(4)(1)(Z)
18.0	C05(6)G180(4)2G5C(1)	CC05CH180(4)	CCR05CH180(4)(1)(Z)
20.0	C05(6)G200(4)2G5C(1)	CC05CG200(4)	CCR05CG200(4)(1)(Z)
22.0	C05(6)G220(4)2G5C(1)	CC05CG220(4)	CCR05CG220(4)(1)(Z)
24.0	C05(6)G240(4)2G5C(1)	CC05CG240(4)	CCR05CG240(4)(1)(Z)
27.0	C05(6)G270(4)2G5C(1)	CC05CG270(4)	CCR05CG270(4)(1)(Z)
30.0	C05(6)G300(4)2G5C(1)	CC05CG300(4)	CCR05CG300(4)(1)(Z)
33.0	C05(6)G330(4)2G5C(1)	CC05CG330(4)	CCR05CG330(4)(1)(Z)
36.0	C05(6)G360(4)2G5C(1)	CC05CG360(4)	CCR05CG360(4)(1)(Z)
39.0	C05(6)G390(4)2G5C(1)	CC05CG390(4)	CCR05CG390(4)(1)(Z)
43.0	C05(6)G430(4)2G5C(1)	CC05CG430(4)	CCR05CG430(4)(1)(Z)
47.0	C05(6)G470(4)2G5C(1)	CC05CG470(4)	CCR05CG470(4)(1)(Z)
51.0	C05(6)G510(4)2G5C(1)	CC05CG510(4)	CCR05CG510(4)(1)(Z)

620.0	C05(6)G621(4)1G5C(1)	CC05CG621(4)	CCR05CG621(4)(1)(Z)
680.0	C05(6)G681(4)1G5C(1)	CC05CG681(4)	CCR05CG681(4)(1)(Z)
750.0	C05(6)G751(4)1G5C(1)	CC05CG751(4)	CCR05CG751(4)(1)(Z)
820.0	C05(6)G821(4)1G5C(1)	CC05CG821(4)	CCR05CG821(4)(1)(Z)
910.0	C05(6)G911(4)1G5C(1)	CC05CG911(4)	CCR05CG911(4)(1)(Z)
1,000.0	C05(6)G102(4)1G5C(1)	CC05CG102(4)	CCR05CG102(4)(1)(Z)
1,100.0	C05(6)G112(4)1G5C(1)	CC05CG112(4)	CCR05CG112(4)(1)(Z)
1,200.0	C05(6)G122(4)1G5C(1)	CC05CG122(4)	CCR05CG122(4)(1)(Z)
1,300.0	C05(6)G132(4)1G5C(1)	CC05CG132(4)	CCR05CG132(4)(1)(Z)
1,500.0	C05(6)G152(4)1G5C(1)	CC05CG152(4)	CCR05CG152(4)(1)(Z)
1,600.0	C05(6)G162(4)1G5C(1)	CC05CG162(4)	CCR05CG162(4)(1)(Z)
1,800.0	C05(6)G182(4)1G5C(1)	CC05CG182(4)	CCR05CG182(4)(1)(Z)

50 VOLT — C052/C056 SIZE (CC(R)05 PER MIL-PRF-20/35)

2,000.0	C05(6)G202(4)5G5C(1)	CC05CG202(4)	CCR05CG202(4)(1)(Z)
2,200.0	C05(6)G222(4)5G5C(1)	CC05CG222(4)	CCR05CG222(4)(1)(Z)
2,400.0	C05(6)G242(4)5G5C(1)	CC05CG242(4)	CCR05CG242(4)(1)(Z)
2,700.0	C05(6)G272(4)5G5C(1)	CC05CG272(4)	CCR05CG272(4)(1)(Z)
3,000.0	C05(6)G302(4)5G5C(1)	CC05CG302(4)	CCR05CG302(4)(1)(Z)
3,300.0	C05(6)G332(4)5G5C(1)	CC05CG332(4)	CCR05CG332(4)(1)(Z)

To complete Part Number, insert the following letters:

(1) Available Failure Rates: A (CC styles only); M, P, R & S (CCR styles only).

(2) Available Capacitance Tolerances: B, C.

(3) Available Capacitance Tolerances: B, C, D.

(4) Available Capacitance Tolerances: F, G, J.

(5) Available Capacitance Tolerances: F, G, J, K.

(6) Insert "2" for standard design, Style C052G } Stand-offs are available

Insert "6" for stand-off design, Style C056G } only as CCR's, not available as CC.

(7) Add "V" for stand-off design, Style C056G

And leave blank for the flat bottom design (C052G)

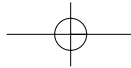

3,500.0	C06(6)G552(4)1G5C(1)	CC06CG552(4)	CCR06CG552(4)(1)(7)
4,300.0	C06(6)G432(4)1G5C(1)	CC06CG432(4)	CCR06CG432(4)(1)(7)
4,700.0	C06(6)G472(4)1G5C(1)	CC06CG472(4)	CCR06CG472(4)(1)(7)
50 VOLT — C062/C066 SIZE (CC(R)06 PER MIL-PRF-20/36)			
5,100.0	C06(6)G512(5)5G5C(1)	CC06CG512(5)	CCR06CG512(5)(1)(7)
5,600.0	C06(6)G562(5)5G5C(1)	CC06CG562(5)	CCR06CG562(5)(1)(7)
6,200.0	C06(6)G622(5)5G5C(1)	CC06CG622(5)	CCR06CG622(5)(1)(7)
6,800.0	C06(6)G682(5)5G5C(1)	CC06CG682(5)	CCR06CG682(5)(1)(7)
7,500.0	C06(6)G752(5)5G5C(1)	CC06CG752(5)	CCR06CG752(5)(1)(7)

- To complete Part Number, insert the following letters:
- (1) Available Failure Rates: A (CC styles only); M, P, R & S (CCR styles only).
 - (2) Available Capacitance Tolerances: B, C.
 - (3) Available Capacitance Tolerances: B, C, D.
 - (4) Available Capacitance Tolerances: F, G, J.
 - (5) Available Capacitance Tolerances: F, G, J, K.
 - (6) Insert "2" for standard design, Style C062G
 Insert "6" for stand-off design, Style C066G } Stand-offs are available only as CCR's, not available as CC.
 - (7) Add "V" for stand-off design, Style C066G
 And leave blank for the flat bottom design (C062G)
 - (8) Available Capacitance Tolerances: G, J, K

56,000.0	C512G563(5)5G5C(1)	CC07CG563(5)	CCR07CG563(5)(1)
68,000.0	C512G683(5)5G5C(1)	CC07CG683(5)	CCR07CG683(5)(1)
83,000.0	C512G823(5)5G5C(1)	CC07CG823(5)	CCR07CG823(5)(1)
100,000.0	C512G104(5)5G5C(1)	CC07CG104(5)	CCR07CG104(5)(1)
200 VOLT — C522 SIZE (CC(R)08 PER MIL-PRF-20/38)			
3,900.0	C522G392(8)2G5C(1)	CC08CG392(8)	CCR08CG392(8)(1)
4,700.0	C522G472(8)2G5C(1)	CC08CG472(8)	CCR08CG472(8)(1)
100 VOLT — C522 SIZE (CC(R)08 PER MIL-PRF-20/38)			
15,000.0	C522G153(8)1G5C(1)	CC08CG153(8)	CCR08CG153(8)(1)
18,000.0	C522G183(8)1G5C(1)	CC08CG183(8)	CCR08CG183(8)(1)
50 VOLT — C522 SIZE (CC(R)08 PER MIL-PRF-20/38)			
56,000.0	C522G563(8)5G5C(1)	CC08CG563(8)	CCR08CG563(8)(1)
68,000.0	C522G683(8)5G5C(1)	CC08CG683(8)	CCR08CG683(8)(1)

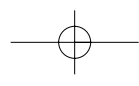

CAPACITOR OUTLINE DRAWINGS (RADIAL LEADS)

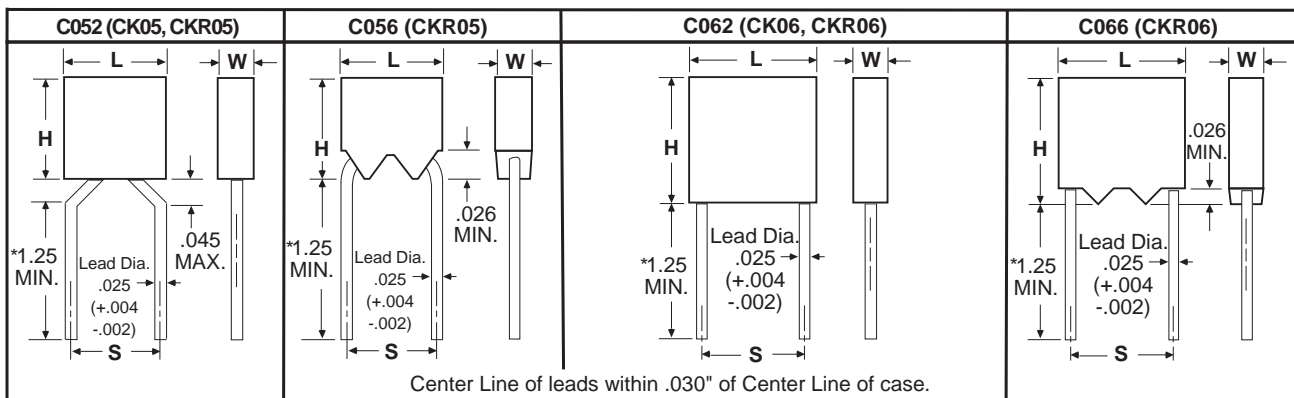

* Leads are .625 minimum when tape and reel packaged.

DIMENSIONS – INCHES & (MILLIMETERS)

CASE SIZE	MILITARY EQUIVALENT STYLES	H HEIGHT	L LENGTH	W WIDTH	S LEAD SPACING
C052/ C056	CK05, CKR05	.190 ± .010 (4.83 ± .25)	.190 ± .010 (4.83 ± .25)	.090 ± .010 (2.29 ± .25)	.200 ± .015 (5.08 ± .38)
C062/ C066	CK06, CKR06	.290 ± .010 (7.37 ± .25)	.290 ± .010 (7.37 ± .25)	.090 ± .010 (2.29 ± .25)	.200 ± .015 (5.08 ± .38)

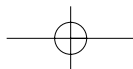

C062	C192
C066	C202
	C222

****Part Number Example: C052K102K2X5CA (14 digits – no spaces)**

MARKING INFORMATION

C114T (CKR11) THROUGH C222T (CKR16) PER MIL-PRF-39014

C114T (CKR11)

JK	J for JAN K for KEMET
103	Capacitance
KP0	Capacitance Tolerance, FR Level
37A	& Date Code (Yr.) Date and Lot Code

C124T (CKR12)

CKR12	Style
2657J	Dash No., J for JAN
0037A	Date & Lot Code
31433	Source Code (Federal Supply Code for Manufacturers, FSCM)

C192T (CKR14) C202T (CKR15) C222T (CKR16)

M39014	Complete Part Number
5-2125	Manufacturer's Name
KEMET	
0037A	Date & Lot Code
J50V	JAN & Voltage
105K	Capacitance, pF Code, Capacitance Tolerance

C052/56T (CKR05) PER MIL-PRF-39014/01

	FRONT	BACK
Specification	M390	JK — JAN-KEMET
Sheet No.	14/01	0037 — Date Code
Four Digit Part No.	1579*	A — Lot Code

*Add "V" as the last digit for stand-off leads.

C062/66T (CKR06) PER MIL-PRF-39014/02

	FRONT	BACK
Complete MIL Part No.	M39014	0037A — Date & Lot Code
Manufacturer's Name	2-1338	J200V — JAN & Voltage
	*KEMET	103K — Capacitance, pF Code, Capacitance Tolerance

*Add "V" as the last digit for stand-off leads.

C114K (CK12) THROUGH C222K (CK16) PER MIL-C-11015

C114K (CK12) C124K (CK13)

KCK	KEMET, CK
12BX	Style (12 or 13), Temp. Char. (BX or BR)
102K	Capacitance, pF Code, Capacitance Tolerance
0037	Date Code

C192K (CK14) C202K (CK15) C222K (CK16)

K100V	KEMET, Voltage
CK14BX	Style (14, 15 or 16), Temp. Char. (BX or BR)
123K	Capacitance, pF Code, Capacitance Tolerance
0037	Date Code

C052K (CK05) PER MIL-C-11015/18 & C062K (CK06) PER MIL-C-11015/19

	FRONT	BACK
Style	CK05	200V — Voltage
Temperature Characteristic	BX	K — KEMET
Capacitance, pF Code, Capacitance Tolerance	102K	0001 — Date Code

KEMET Electronics Corporation, P.O. Box 5928, Greenville, S.C. 29606, (864) 963-6300

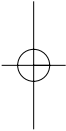

470	20	C114(1)471M1X5C(2)	CK12BX471M	CKR11BX471M(2)	2632	2832	2032	2232
560	10	C114(1)561K1X5C(2)	CK12BX561K	CKR11BX561K(2)	2633	2833	2033	2233
680	10	C114(1)681K1X5C(2)	CK12BX681K	CKR11BX681K(2)	2634	2834	2034	2234
680	20	C114(1)681M1X5C(2)	CK12BX681M	CKR11BX681M(2)	2635	2835	2035	2235
820	10	C114(1)821K1X5C(2)	CK12BX821K	CKR11BX821K(2)	2636	2836	2036	2236
1,000	10	C114(1)102K1X5C(2)	CK12BX102K	CKR11BX102K(2)	2637	2837	2037	2237
1,000	20	C114(1)102M1X5C(2)	CK12BX102M	CKR11BX102M(2)	2638	2838	2038	2238
1,200	10	C114(1)122K1X5C(2)	CK12BX122K	CKR11BX122K(2)	2639	2839	2039	2239
1,500	10	C114(1)152K1X5C(2)	CK12BX152K	CKR11BX152K(2)	2640	2840	2040	2240
1,500	20	C114(1)152M1X5C(2)	CK12BX152M	CKR11BX152M(2)	2641	2841	2041	2241
1,800	10	C114(1)182K1X5C(2)	CK12BX182K	CKR11BX182K(2)	2642	2842	2042	2242
2,200	10	C114(1)222K1X5C(2)	CK12BX222K	CKR11BX222K(2)	2643	2843	2043	2243
2,200	20	C114(1)222M1X5C(2)	CK12BX222M	CKR11BX222M(2)	2644	2844	2044	2244
2,700	10	C114(1)272K1X5C(2)	CK12BX272K	CKR11BX272K(2)	2645	2845	2045	2245
3,300	10	C114(1)332K1X5C(2)	CK12BX332K	CKR11BX332K(2)	2646	2846	2046	2246
3,300	20	C114(1)332M1X5C(2)	CK12BX332M	CKR11BX332M(2)	2647	2847	2047	2247
3,900	10	C114(1)392K1X5C(2)	CK12BX392K	CKR11BX392K(2)	2648	2848	2048	2248
4,700	10	C114(1)472K1X5C(2)	CK12BX472K	CKR11BX472K(2)	2649	2849	2049	2249
4,700	20	C114(1)472M1X5C(2)	CK12BX472M	CKR11BX472M(2)	2650	2850	2050	2250
50 VOLT — C114 SIZE (MILITARY—CK12 or CKR11)								
5,600	10	C114(1)562K5X5C(2)	CK12BX562K	CKR11BX562K(2)	2651	2851	2051	2251
6,800	10	C114(1)682K5X5C(2)	CK12BX682K	CKR11BX682K(2)	2652	2852	2052	2252
6,800	20	C114(1)682M5X5C(2)	CK12BX682M	CKR11BX682M(2)	2653	2853	2053	2253
8,200	10	C114(1)822K5X5C(2)	CK12BX822K	CKR11BX822K(2)	2654	2854	2054	2254
10,000	10	C114(1)103K5X5C(2)	CK12BX103K	CKR11BX103K(2)	2655	2855	2055	2255
10,000	20	C114(1)103M5X5C(2)	CK12BX103M	CKR11BX103M(2)	2656	2856	2056	2256
100 VOLT — C124 SIZE (MILITARY—CK13 or CKR12)								
5,600	10	C124(1)562K1X5C(2)	CK13BX562K	CKR12BX562K(2)	2657	2857	2057	2257
6,800	10	C124(1)682K1X5C(2)	CK13BX682K	CKR12BX682K(2)	2658	2858	2058	2258
6,800	20	C124(1)682M1X5C(2)	CK13BX682M	CKR12BX682M(2)	2659	2859	2059	2259
8,200	10	C124(1)822K1X5C(2)	CK13BX822K	CKR12BX822K(2)	2660	2860	2060	2260
10,000	10	C124(1)103K1X5C(2)	CK13BX103K	CKR12BX103K(2)	2661	2861	2061	2261
10,000	20	C124(1)103M1X5C(2)	CK13BX103M	CKR12BX103M(2)	2662	2862	2062	2262
50 VOLT — C124 SIZE (MILITARY—CK13 or CKR12)								
12,000	10	C124(1)123K5X5C(2)	CK13BX123K	CKR12BX123K(2)	2663	2863	2063	2263
15,000	10	C124(1)153K5X5C(2)	CK13BX153K	CKR12BX153K(2)	2664	2864	2064	2264
15,000	20	C124(1)153M5X5C(2)	CK13BX153M	CKR12BX153M(2)	2665	2865	2065	2265
18,000	10	C124(1)183K5X5C(2)	CK13BX183K	CKR12BX183K(2)	2666	2866	2066	2266
22,000	10	C124(1)223K5X5C(2)	CK13BX223K	CKR12BX223K(2)	2667	2867	2067	2267
22,000	20	C124(1)223M5X5C(2)	CK13BX223M	CKR12BX223M(2)	2668	2868	2068	2268
27,000	10	C124K273K5R5CA	CK13BR273K					
33,000	10	C124K333K5R5CA	CK13BR333K					
33,000	20	C124K333M5R5CA	CK13BR333M					
39,000	10	C124K393K5R5CA	CK13BR393K					
47,000	10	C124K473K5R5CA	CK13BR473K					
47,000	20	C124K473M5R5CA	CK13BR473M					

(1) Insert proper letter for specification: K — MIL-C-11015; T — MIL-PRF-39014 (2) Failure Rate Designator: A — Not applicable (MIL-C-11015); M — 1%/1000 Hours, P — .1%/1000 Hours, R — .01%/1000 Hours, S — .001%/1000 Hours (MIL-PRF-39014)

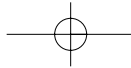

100,000	10	C192T104K5X5C(2)		CKR14BX104K(2)	2691	2891	2091	2291
100,000	20	C192T104M5X5C(2)		CKR14BX104M(2)	2692	2892	2092	2292
120,000	10	C192(1)124K5R5C(2)	CK14BR124K	CKR14BR124K(2)	2699	2899	2099	2299
150,000	10	C192(1)154K5R5C(2)	CK14BR154K	CKR14BR154K(2)	2700	2900	2100	2300
150,000	20	C192(1)154M5R5C(2)	CK14BR154M	CKR14BR154M(2)	2701	2901	2101	2301
180,000	10	C192(1)184K5R5C(2)	CK14BR184K	CKR14BR184K(2)	2702	2902	2102	2302
220,000	10	C192(1)224K5R5C(2)	CK14BR224K	CKR14BR224K(2)	2703	2903	2103	2303
220,000	20	C192(1)224M5R5C(2)	CK14BR224M	CKR14BR224M(2)	2704	2904	2104	2304
270,000	10	C192(1)274K5R5C(2)	CK14BR274K	CKR14BR274K(2)	2705	2905	2105	2305
100 VOLT – C202 SIZE (MILITARY – CK15 or CKR15)								
56,000	10	C202T563K1X5C(2)		CKR15BX563K(2)	2706	2906	2106	2306
68,000	10	C202T683K1X5C(2)		CKR15BX683K(2)	2707	2907	2107	2307
68,000	20	C202T683M1X5C(2)		CKR15BX683M(2)	2708	2908	2108	2308
82,000	10	C202T823K1X5C(2)		CKR15BX823K(2)	2709	2909	2109	2309
100,000	10	C202(1)104K1X5C(2)	CK15BX104K	CKR15BX104K(2)	2710	2910	2110	2310
100,000	20	C202(1)104M1X5C(2)	CK15BX104M	CKR15BX104M(2)	2711	2911	2111	2311
120,000	10	C202(1)124K1R5C(2)	CK15BR124K	CKR15BR124K(2)	2712	2912	2112	2312
150,000	10	C202(1)154K1R5C(2)	CK15BR154K	CKR15BR154K(2)	2713	2913	2113	2313
150,000	20	C202(1)154M1R5C(2)	CK15BR154M	CKR15BR154M(2)	2714	2914	2114	2314
180,000	10	C202(1)184K1R5C(2)	CK15BR184K	CKR15BR184K(2)	2715	2915	2115	2315
220,000	10	C202(1)224K1R5C(2)	CK15BR224K	CKR15BR224K(2)	2716	2916	2116	2316
220,000	20	C202(1)224M1R5C(2)	CK15BR224M	CKR15BR224M(2)	2717	2917	2117	2317
270,000	10	C202(1)274K1R5C(2)	CK15BR274K	CKR15BR274K(2)	2718	2918	2118	2318
330,000	10	C202(1)334K1R5C(2)	CK15BR334K	CKR15BR334K(2)	2719	2919	2119	2319
330,000	20	C202(1)334M1R5C(2)	CK15BR334M	CKR15BR334M(2)	2720	2920	2120	2320
50 VOLT – C202 SIZE (MILITARY – CK15 or CKR15)								
470,000	10	C202(1)474K5R5C(2)	CK15BR474K	CKR15BR474K(2)	2721	2921	2121	2321
470,000	20	C202(1)474M5R5C(2)	CK15BR474M	CKR15BR474M(2)	2722	2922	2122	2322
680,000	10	C202T684K5R5C(2)		CKR15BR684K(2)	2723	2923	2123	2323
680,000	20	C202T684M5R5C(2)		CKR15BR684M(2)	2724	2924	2124	2324
1,000,000	10	C202(1)105K5R5C(2)	CK15BR105K	CKR15BR105K(2)	2725	2925	2125	2325
1,000,000	20	C202(1)105M5R5C(2)	CK15BR105M	CKR15BR105M(2)	2726	2926	2126	2326
100 VOLT – C222 SIZE (MILITARY – CK16 or CKR16)								
470,000	10	C222(1)474K1R5C(2)	CK16BR474K	CKR16BR474K(2)	2727	2927	2127	2327
470,000	20	C222(1)474M1R5C(2)	CK16BR474M	CKR16BR474M(2)	2728	2928	2128	2328
680,000	10	C222T684K1R5C(2)		CKR16BR684K(2)	2729	2929	2129	2329
680,000	20	C222T684M1R5C(2)		CKR16BR684M(2)	2730	2930	2130	2330
1,000,000	10	C222(1)105K1R5C(2)	CK16BR105K	CKR16BR105K(2)	2731	2931	2131	2331
1,000,000	20	C222(1)105M1R5C(2)	CK16BR105M	CKR16BR105M(2)	2732	2932	2132	2332
50 VOLT – C222 SIZE (MILITARY – CK16 or CKR16)								
2,200,000	10	C222(1)225K5R5C(2)	CK16BR225K	CKR16BR225K(2)	2733	2933	2133	2333
2,200,000	20	C222(1)225M5R5C(2)	CK16BR225M	CKR16BR225M(2)	2734	2934	2134	2334
3,300,000	10	C222(1)335K5R5C(2)	CK16BR335M	CKR16BR335K(2)	2735	2935	2135	2335
3,300,000	20	C222(1)335M5R5C(2)	CK16BR335M	CKR16BR335M(2)	2736	2936	2136	2336

(1) Insert proper letter for specification: K – MIL-C-11015; T – MIL-PRF-39014 (2) Failure Rate Designator: A – Not applicable (MIL-C-11015); M – 1%/1000 Hours, P – .1%/1000 Hours, R – .01%/1000 Hours, S – .001%/1000 Hours (MIL-PRF-39014)

KEMET Electronics Corporation, P.O. Box 5928, Greenville, S.C. 29606, (864) 963-6300

29

MIL-C-11015

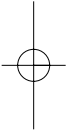

470	20	C05(4)(1)471M2X5C(2)	CK05BX471M	CKR05BX471M(2)(3)	1232(3)	1272(3)	1312(3)	1352(3)
560	10	C05(4)(1)561K2X5C(2)	CK05BX561K	CKR05BX561K(2)(3)	1233(3)	1273(3)	1313(3)	1353(3)
680	10	C05(4)(1)681K2X5C(2)	CK05BX681K	CKR05BX681K(2)(3)	1234(3)	1274(3)	1314(3)	1354(3)
680	20	C05(4)(1)681M2X5C(2)	CK05BX681M	CKR05BX681M(2)(3)	1235(3)	1275(3)	1315(3)	1355(3)
820	10	C05(4)(1)821K2X5C(2)	CK05BX821K	CKR05BX821K(2)(3)	1236(3)	1276(3)	1316(3)	1356(3)
1,000	10	C05(4)(1)102K2X5C(2)	CK05BX102K	CKR05BX102K(2)(3)	1237(3)	1277(3)	1317(3)	1357(3)
1,000	20	C05(4)(1)102M2X5C(2)	CK05BX102M	CKR05BX102M(2)(3)	1238(3)	1278(3)	1318(3)	1358(3)
100 VOLT — C052/C056 SIZE (MILITARY — CK05 or CKR05)								
1,200	10	C05(4)(1)122K1X5C(2)	CK05BX122K	CKR05BX122K(2)(3)	1239(3)	1279(3)	1319(3)	1359(3)
1,500	10	C05(4)(1)152K1X5C(2)	CK05BX152K	CKR05BX152K(2)(3)	1240(3)	1280(3)	1320(3)	1360(3)
1,500	20	C05(4)(1)152M1X5C(2)	CK05BX152M	CKR05BX152M(2)(3)	1441(3)	1481(3)	1521(3)	1561(3)
1,800	10	C05(4)(1)182K1X5C(2)	CK05BX182K	CKR05BX182K(2)(3)	1442(3)	1482(3)	1522(3)	1562(3)
2,200	10	C05(4)(1)222K1X5C(2)	CK05BX222K	CKR05BX222K(2)(3)	1443(3)	1483(3)	1523(3)	1563(3)
2,200	20	C05(4)(1)222M1X5C(2)	CK05BX222M	CKR05BX222M(2)(3)	1444(3)	1484(3)	1524(3)	1564(3)
2,700	10	C05(4)(1)272K1X5C(2)	CK05BX272K	CKR05BX272K(2)(3)	1445(3)	1485(3)	1525(3)	1565(3)
3,300	10	C05(4)(1)332K1X5C(2)	CK05BX332K	CKR05BX332K(2)(3)	1446(3)	1486(3)	1526(3)	1566(3)
3,300	20	C05(4)(1)332M1X5C(2)	CK05BX332M	CKR05BX332M(2)(3)	1447(3)	1487(3)	1527(3)	1567(3)
3,900	10	C05(4)(1)392K1X5C(2)	CK05BX392K	CKR05BX392K(2)(3)	1448(3)	1488(3)	1528(3)	1568(3)
4,700	10	C05(4)(1)472K1X5C(2)	CK05BX472K	CKR05BX472K(2)(3)	1449(3)	1489(3)	1529(3)	1569(3)
4,700	20	C05(4)(1)472M1X5C(2)	CK05BX472M	CKR05BX472M(2)(3)	1450(3)	1490(3)	1530(3)	1570(3)
5,600	10	C05(4)(1)562K1X5C(2)	CK05BX562K	CKR05BX562K(2)(3)	1451(3)	1491(3)	1531(3)	1571(3)
6,800	10	C05(4)(1)682K1X5C(2)	CK05BX682K	CKR05BX682K(2)(3)	1452(3)	1492(3)	1532(3)	1572(3)
6,800	20	C05(4)(1)682M1X5C(2)	CK05BX682M	CKR05BX682M(2)(3)	1453(3)	1493(3)	1533(3)	1573(3)
8,200	10	C05(4)(1)822K1X5C(2)	CK05BX822K	CKR05BX822K(2)(3)	1454(3)	1494(3)	1534(3)	1574(3)
10,000	10	C05(4)(1)103K1X5C(2)	CK05BX103K	CKR05BX103K(2)(3)	1455(3)	1495(3)	1535(3)	1575(3)
10,000	20	C05(4)(1)103M1X5C(2)	CK05BX103M	CKR05BX103M(2)(3)	1456(3)	1496(3)	1536(3)	1576(3)
50 VOLT — C052/C056 SIZE (MILITARY — CK05 or CKR05)								
12,000	10	C05(4)(1)123K5X5C(2)	CK05BX123K	CKR05BX123K(2)(3)	1457(3)	1497(3)	1537(3)	1577(3)
15,000	10	C05(4)(1)153K5X5C(2)	CK05BX153K	CKR05BX153K(2)(3)	1458(3)	1498(3)	1538(3)	1578(3)
15,000	20	C05(4)(1)153M5X5C(2)	CK05BX153M	CKR05BX153M(2)(3)	1459(3)	1499(3)	1539(3)	1579(3)
18,000	10	C05(4)(1)183K5X5C(2)	CK05BX183K	CKR05BX183K(2)(3)	1460(3)	1500(3)	1540(3)	1580(3)
22,000	10	C05(4)(1)223K5X5C(2)	CK05BX223K	CKR05BX223K(2)(3)	1461(3)	1501(3)	1541(3)	1581(3)
22,000	20	C05(4)(1)223M5X5C(2)	CK05BX223M	CKR05BX223M(2)(3)	1462(3)	1502(3)	1542(3)	1582(3)
27,000	10	C05(4)(1)273K5X5C(2)	CK05BX273K	CKR05BX273K(2)(3)	1463(3)	1503(3)	1543(3)	1583(3)
33,000	10	C05(4)(1)333K5X5C(2)	CK05BX333K	CKR05BX333K(2)(3)	1464(3)	1504(3)	1544(3)	1584(3)
33,000	20	C05(4)(1)333M5X5C(2)	CK05BX333M	CKR05BX333M(2)(3)	1465(3)	1505(3)	1545(3)	1585(3)
39,000	10	C05(4)(1)393K5X5C(2)	CK05BX393K	CKR05BX393K(2)(3)	1466(3)	1506(3)	1546(3)	1586(3)
47,000	10	C05(4)(1)473K5X5C(2)	CK05BX473K	CKR05BX473K(2)(3)	1467(3)	1507(3)	1547(3)	1587(3)
47,000	20	C05(4)(1)473M5X5C(2)	CK05BX473M	CKR05BX473M(2)(3)	1468(3)	1508(3)	1548(3)	1588(3)
56,000	10	C05(4)(1)563K5X5C(2)	CK05BX563K	CKR05BX563K(2)(3)	1469(3)	1509(3)	1549(3)	1589(3)
68,000	10	C05(4)(1)683K5X5C(2)	CK05BX683K	CKR05BX683K(2)(3)	1470(3)	1510(3)	1550(3)	1590(3)
68,000	20	C05(4)(1)683M5X5C(2)	CK05BX683M	CKR05BX683M(2)(3)	1471(3)	1511(3)	1551(3)	1591(3)
82,000	10	C05(4)(1)823K5X5C(2)	CK05BX823K	CKR05BX823K(2)(3)	1472(3)	1512(3)	1552(3)	1592(3)
100,000	10	C05(4)(1)104K5X5C(2)	CK05BX104K	CKR05BX104K(2)(3)	1473(3)	1513(3)	1553(3)	1593(3)
100,000	20	C05(4)(1)104M5X5C(2)	CK05BX104M	CKR05BX104M(2)(3)	1474(3)	1514(3)	1554(3)	1594(3)

(1) Insert proper letter for specification: K — MIL-C-11015; T — MIL-PRF-39014 (2) Failure Rate Designator: A — Not applicable (MIL-C-11015); M — 1%/1000 Hours, P — .1%/1000 Hours, R — .01%/1000 Hours, S — .001%/1000 Hours (MIL-PRF-39014)
 (3) Insert "V" for standard design (C056). Leave blank for the flat bottom design (C052).
 (4) Insert "2" for standard design (Style C052) } Note: Stand-offs are available only
 Insert "6" for stand-off design (Style C056) } with the CKR, not the CK.

30

KEMET Electronics Corporation, P.O. Box 5928, Greenville, S.C. 29606, (864) 963-6300

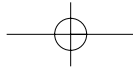

56,000	10	C06(4)(1)563K1X5C(2)	CK06BX563K	CKR06BX563K(2)(3)	1226(3)	1266(3)	1306(3)	1346(3)
68,000	10	C06(4)(1)683K1X5C(2)	CK06BX683K	CKR06BX683K(2)(3)	1227(3)	1267(3)	1307(3)	1347(3)
68,000	20	C062K683M1X5CA	CK06BX683M					
82,000	10	C06(4)(1)823K1X5C(2)	CK06BX823K	CKR06BX823K(2)(3)	1229(3)	1269(3)	1309(3)	1349(3)
100,000	10	C06(4)(1)104K1X5C(2)	CK06BX104K	CKR06BX104K(2)(3)	1230(3)	1270(3)	1310(3)	1350(3)
100,000	20	C062K104M1X5CA	CK06BX104M					
50 VOLT — C062/C066 SIZE (MILITARY — CK06 or CKR06)								
120,000	10	C06(4)(1)124K5X5C(2)	CK06BX124K	CKR06BX124K(2)(3)	1233(3)	1273(3)	1313(3)	1353(3)
150,000	10	C06(4)(1)154K5X5C(2)	CK06BX154K	CKR06BX154K(2)(3)	1234(3)	1274(3)	1314(3)	1354(3)
150,000	20	C062K154M5X5CA	CK06BX154M					
180,000	10	C06(4)(1)184K5X5C(2)	CK06BX184K	CKR06BX184K(2)(3)	1235(3)	1275(3)	1315(3)	1355(3)
220,000	10	C06(4)(1)224K5X5C(2)	CK06BX224K	CKR06BX224K(2)(3)	1236(3)	1276(3)	1316(3)	1356(3)
220,000	20	C062K224M5X5CA	CK06BX224M					
270,000	10	C06(4)(1)274K5X5C(2)	CK06BX274K	CKR06BX274K(2)(3)	1237(3)	1277(3)	1317(3)	1357(3)
330,000	10	C06(4)(1)334K5X5C(2)	CK06BX334K	CKR06BX334K(2)(3)	1238(3)	1278(3)	1318(3)	1358(3)
330,000	20	C062K334M5X5CA	CK06BX334M					
390,000	10	C06(4)(1)394K5X5C(2)	CK06BX394K	CKR06BX394K(2)(3)	1239(3)	1279(3)	1319(3)	1359(3)
470,000	10	C06(4)(1)474K5X5C(2)	CK06BX474K	CKR06BX474K(2)(3)	1240(3)	1280(3)	1320(3)	1360(3)
470,000	20	C062K474M5X5CA	CK06BX474M					
560,000	10	C06(4)(1)564K5X5C(2)	CK06BX564K	CKR06BX564K(2)(3)	1404(3)	1408(3)	1412(3)	1416(3)
680,000	10	C06(4)(1)684K5X5C(2)	CK06BX684K	CKR06BX684K(2)(3)	1405(3)	1409(3)	1413(3)	1417(3)
680,000	20	C062K684M5X5CA	CK06BX684M					
820,000	10	C06(4)(1)824K5X5C(2)	CK06BX824K	CKR06BX824K(2)(3)	1406(3)	1410(3)	1414(3)	1418(3)
1,000,000	10	C06(4)(1)105K5X5C(2)	CK06BX105K	CKR06BX105K(2)(3)	1407(3)	1411(3)	1415(3)	1419(3)
1,000,000	20	C062K105M5X5CA	CK06BX105M					

(1) Insert proper letter for specification: K — MIL-C-11015; T — MIL-PRF-39014.

(2) Failure Rate Designator: A — Not applicable (MIL-C-11015); M — 1%/1000 Hours, P — .1%/1000 Hours, R — .01%/1000 Hours, S — .001%/1000 Hours (MIL-PRF-39014)

(3) Add "V" for stand-off design (C066). Leave blank for the flat bottom design (C062).

(4) Insert "2" for standard design (Style C062). Insert "6" for stand-off design (Style C066). Note: Stand-offs are available only with the CKR, not the CK.

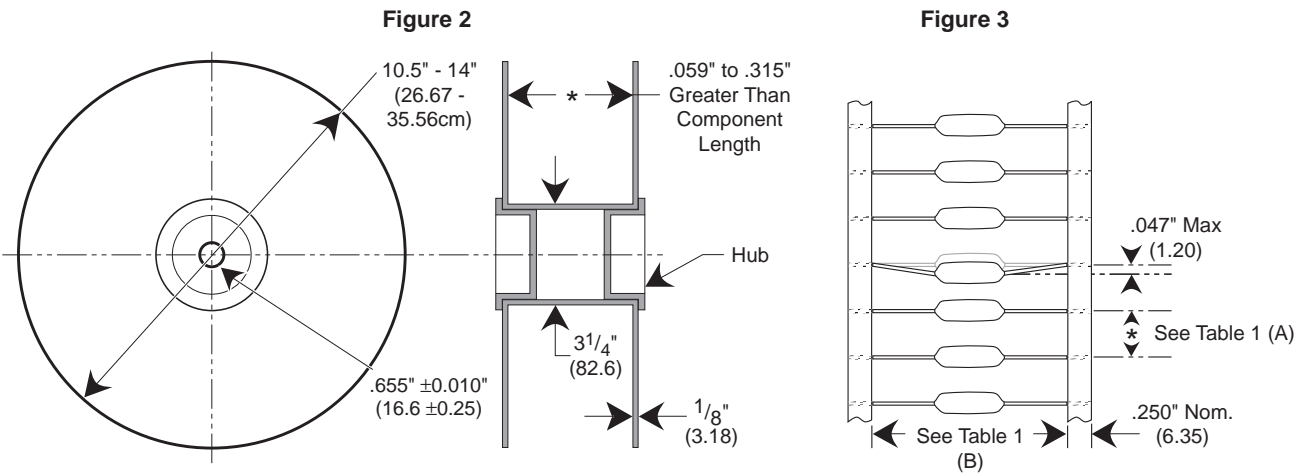
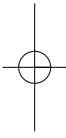
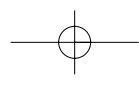

Table 1 Dimensions in Inches & (Millimeters)

Component Body Diameter	Component Pitch "A"	Inside Tape Spacing "B" ± 1.5mm (0.059")	
		I	III*
0" (0mm) to 0.197" (5mm)	0.197" or (5mm)	2.062" (52.4mm)	
0.197" (5.01mm) to 0.394" (10mm)	0.394" or (10mm)		2.874" (73mm)

* Not Available for Conformally Coated Parts.



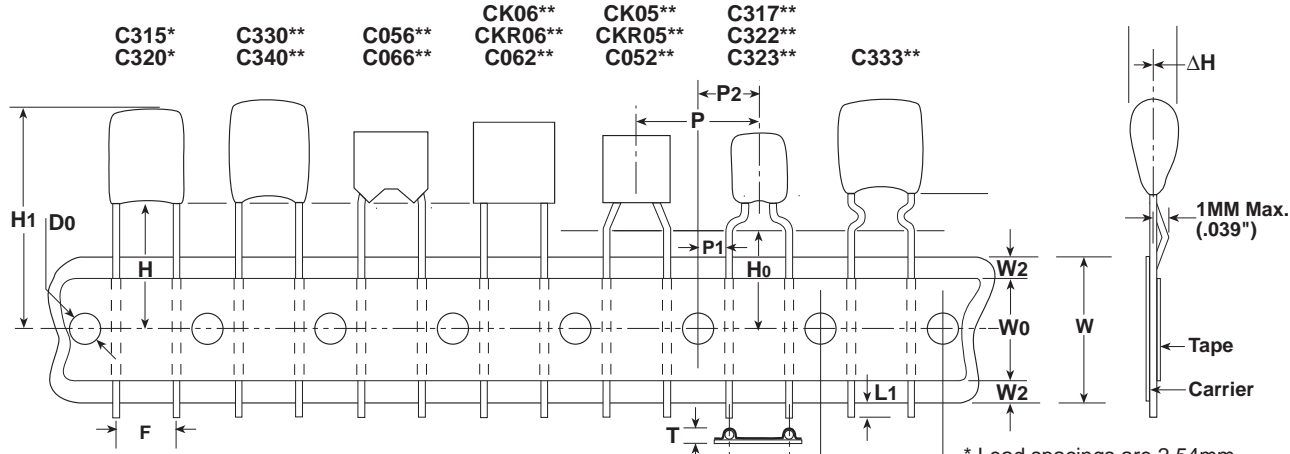

Figure 2: Lead Tape Configuration (See Table Below)

* Lead spacings are 2.54mm (.10") center-to-center.
 ** Lead spacings are 5.08mm (.20") center-to-center.

Ceramic Radial Tape and Reel Dimensions in Millimeters & (Inches)

Dimension	Symbol	Nominal mm (inch)		Tolerance mm (inch)		Dimension	Symbol	Nominal mm (inch)		Tolerance mm (inch)	
Sprocket Hole Diameter	Do	4.0 (.157)		± 0.2 (.008)		Height to Seating Plane (formed leads) (2)	Ho	C7301	C7303	C7301	C7303
Sprocket Hole Pitch	P0	12.7 (.500)		± 0.3 (.012)		Component Alignment	Δh	4.0 (.157)		±0.5 (.020) Minimum	
Component Pitch	P	12.7 (.500)		± 0.3 (.012)		Lead Protrusion	L1	1.0 (.039)		Maximum	
Lead Spacing (1)	F	5.08 (.20)	2.54 (.10)	+0.6 -0.2 (+.024 -.008)		Composite Tape Thickness	t	0.7 (.051)		±0.2 (.008)	
Sprocket Hole Center to Lead Center (1)	P1	3.81 (.150)	5.08 (.200)	± 0.7 (.028)		Overall Tape and Lead Thickness	T	1.5 (.059)		Maximum	
Sprocket Hole Center to Component Center	P2	6.35 (.250)		± 1.3 (.051)		Carrier Tape Width	W	18.0 (.709)		+1.0 - 0.5 (+.039 -.020)	
Height to Seating Plane (straight leads) (2)	H	C7301	C7303	C7301	C7303	Hold-Down Tape Width	W0	5.0 (.197)		Minimum	
Component Height Above Tape Center	H1	32.2 (1.27)		Maximum		Hold-Down Tape Location	W2	3.0 (.118)		Maximum	

- (1) Measured at the egress from the carrier tape, on the component side.
 (2) Determined by a 4 digit suffix placed at the end of the part number, as follows:
 7301 = Recommended for parts with formed leads. Example: C322C104K5R5CA7301
 7303 = Recommended for parts with straight leads. Example: C320C104K5R5CA7303

Tape and Reel Packaging

C512G	CC07-CCR07		Footnote (2)	N/A	N/A
C522G	CC08-CCR08		Footnote (2)	N/A	N/A
C114T	CKR11	MIL-PRF-39014	200/Box	5000	12"
C124T	CKR12		200/Box	5000	12"
C192T	CKR14		100/Box	3000	12"
C202T	CKR15		25/Box	500	12"
C222T	CKR16		10/Tray	300	12"
C052/56T	CKR05		100/Bag	1700	12"
C062/66T	CKR06		100/Bag	1500	12"
C31X				500/Bag	2500
C32X			500/Bag	2500	12"
C33X			250/Bag	1500	12"
C340			100/Bag	1000	12"
C350			50/Bag	N/A	N/A
C410			300/Box	5000	12"
C412			200/Box	5000	12"
C420			300/Box	5000	12"
C430			200/Box	2500	12"
C440			200/Box	2500	12"
C512	N/A	N/A	Footnote (2)	N/A	N/A
C522	N/A	N/A	Footnote (2)	N/A	N/A

NOTE: (1) Standard packaging refers to number of pieces per bag, box, tray or vial.

(2) Quantity varies. For further details, please consult the factory.

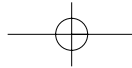

Like all other practical capacitors, multilayer ceramic capacitors also have resistance and inductance. A simplified schematic for the equivalent circuit is shown in Figure 1. Other significant electrical characteristics resulting from these additional properties are as follows:

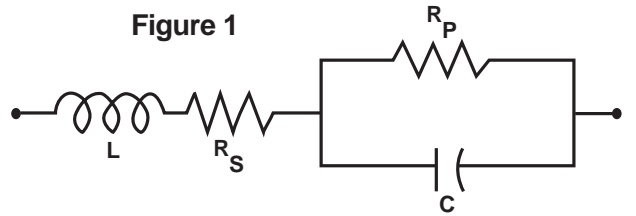

C = Capacitance **RS = Equivalent Series Resistance (ESR)**
L = Inductance **RP = Insulation Resistance (IR)**

Impedance: Since the parallel resistance (Rp) is normally very high, the total impedance of the capacitor is:

$$Z = \sqrt{R_S^2 + (X_C - X_L)^2}$$

Where Z = Total Impedance

RS = Equivalent Series Resistance

XC = Capacitive Reactance = 1/(2 πfC)

XL = Inductive Reactance = 2 πfL

Insulation Resistance: Insulation Resistance (IR) is the DC resistance measured across the terminals of a capacitor, represented by the parallel resistance (Rp) shown in Figure 1. For a given dielectric type, electrode area increases with capacitance, resulting in a decrease in the insulation resistance. Consequently, insulation resistance is usually specified as the “RC” (IR x C) product, in terms of ohm-farads or megohm-microfarads. The insulation resistance for a specific capacitance value is determined by dividing this product by the capacitance. However, as the nominal capacitance values become small, the insulation resistance calculated from the RC product reaches values which are impractical. Consequently, IR specifications usually include both a minimum RC product and a maximum limit on the IR calculated from that value. For example, a typical IR specification might read “1,000 megohm-microfarads or 100 gigohms, whichever is less.”

Insulation Resistance is the measure of a capacitor to resist the flow of DC leakage current. It is sometimes referred to as “leakage resistance.” The DC leakage current may be calculated by dividing the applied voltage by the insulation resistance (Ohm’s Law).

Dielectric Withstanding Voltage: Dielectric withstanding voltage (DWV) is the peak voltage which a capacitor is designed to withstand for short periods of time without damage. All KEMET multilayer ceramic capacitors will withstand a test voltage of 2.5 x the rated voltage for 60 seconds.

KEMET specification limits for these characteristics at standard measurement conditions are shown in Table 1 on page 4. Variations in these properties caused by changing conditions of temperature, voltage, frequency, and time are covered in the following sections.

**EIA TEMPERATURE CHARACTERISTIC CODES
FOR CLASS II & III DIELECTRICS**

Low Temperature Rating		High Temperature Rating		Maximum Capacitance Shift	
Degree Celcius	Letter Symbol	Degree Celcius	Number Symbol	Percent	Letter Symbol
+10C	Z	+45C	2	±1.0%	A
-30C	Y	+65C	4	±1.5%	B
-55C	X	+85C	5	±2.2%	C
		+105C	6	±3.3%	D
		+125C	7	±4.7%	E
		+150C	8	±7.5%	F
		+200C	9	±10.0%	P
				±15.0%	R
				±22.0%	S
				±22/-33%	T
				±22/-56%	U
				±22/-82%	V

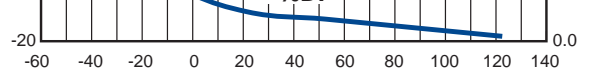

**Figure 4. Temperature °C
Capacitance & DF vs Temperature - X7R**

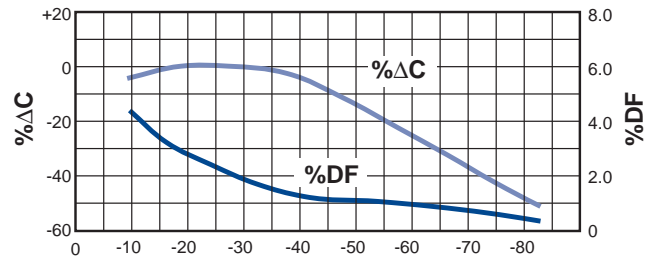

**Figure 5. Temperature °C
Capacitance & DF vs Temperature - Z5U**

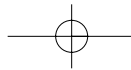

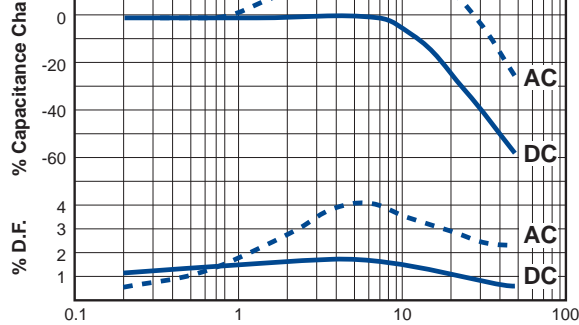

Figure 7. AC or DC Volts Applied
Typical Effects of 1000 Hz AC and DC Voltage Level on
Capacitance and Dissipation Factor - Z5U

Note: C0G Dielectric capacitance and dissipation factor are stable with voltage.

Effect of Temperature: Both capacitance and dissipation factor are affected by variations in temperature. The maximum capacitance change with temperature is defined by the temperature characteristic. However, this only defines a “box” bounded by the upper and lower operating temperatures and the minimum and maximum capacitance values. Within this “box”, the variation with temperature depends upon the specific dielectric formulation. Typical curves for KEMET capacitors are shown in Figures 3, 4, and 5. These figures also include the typical change in dissipation factor for KEMET capacitors.

Insulation resistance decreases with temperature. Typically, the insulation resistance at maximum rated temperature is 10% of the 25°C value.

Effect of Voltage: Class I ceramic capacitors are not affected by variations in applied AC or DC voltages. For Class II and III ceramic capacitors, variations in voltage affect only

multilayer ceramic capacitors are shown in Figures 10, 11, and 12. These curves apply to KEMET capacitors in chip form, without leads. Lead configuration and lead length have a significant impact on the series inductance. The lead inductance is approximately 10nH/inch, which is large compared to the inductance of the chip. The effect of this additional inductance is a decrease in the self-resonant frequency, and an increase in impedance in the inductive region above the self-resonant frequency.

Effect of Time: The capacitance of Class II and III dielectrics change with time as well as with temperature, voltage and frequency. This change with time is known as “aging.” It is caused by gradual realignment of the crystalline structure of the ceramic dielectric material as it is cooled below its Curie temperature, which produces a loss of capacitance with time. The aging process is predictable and follows a logarithmic decay. Typical aging rates for C0G, X7R, and Z5U dielectrics are as follows:

C0G	None
X7R	1.0% per decade of time
Z5U	5.0% per decade of time

Typical aging curves for X7R and Z5U dielectrics are shown in Figure 13.

The aging process is reversible. If the capacitor is heated to a temperature above its Curie point for some period of time, de-aging will occur and the capacitor will regain the capacitance lost during the aging process. The amount of de-aging depends on both the elevated temperature and the length of time at that temperature. Exposure to 150°C for one-half hour or 125°C for two hours is usually sufficient to return the capacitor to its initial value.

Because the capacitance changes rapidly immediately after de-aging, capacitance measurements are usually delayed for at least 10 hours after the de-aging process, which is often referred to as the “last heat.” In addition, manufacturers utilize

Mounting Configuration	Power Dissipation of C052 & C062
1.00" leadwires attached to binding post of GR-1615 bridge (excellent heat sink)	90 Celsius degrees rise per Watt ±10%
0.25" leadwires attached to binding post of GR-1615 bridge	55 Celsius degrees rise per Watt ±10%
Capacitor mounted flush to 0.062" glass-epoxy circuit board with small copper traces	77 Celsius degrees rise per Watt ±10%
Capacitor mounted flush to 0.062" glass-epoxy circuit board with four square inches of copper land area as a heat sink	53 Celsius degrees rise per Watt ±10%

As shown in Table 3, the power dissipation capability of the capacitor is very sensitive to the details of its use environment. The temperature rise due to power dissipation should not exceed 20°C. Using that constraint, the maximum permissible power dissipation may be calculated from the data provided in Table 3.

It is often convenient to translate power dissipation capability into a permissible AC voltage rating. Assuming a sinusoidal wave form, the RMS "ripple voltage" may be calculated from the following formula:

$$E = Z \sqrt{\frac{P}{R}}$$

Where E = RMS Ripple Voltage (volts)

P = Power Dissipation (watts)

Z = Impedance

R = ESR

PRF-39014, and MIL-PRF-55681. Failure rates as low as 0.001% per 1,000 hours are available for all capacitance / voltage ratings covered by these specifications. These specifications and accompanying Qualified Products List should be consulted for details.

For series not covered by these military specifications, an internal testing program is maintained by KEMET Quality Assurance. Samples from each week's production are subjected to a 2,000 hour accelerated life test at 2 x rated voltage and maximum rated temperature. Based on the results of these tests, the average failure rate for all non-military series covered by this test program is currently 0.06% per 1,000 hours at maximum rated conditions. The failure rate would be much lower at typical use conditions. For example, using MIL-HDBK-217D this failure rate translates to 0.9 FITS at 50% rated voltage and 50°C.

Current failure rate details for specific KEMET multilayer ceramic capacitor series are available on request.

MISAPPLICATION

Ceramic capacitors, like any other capacitors, may fail if they are misapplied. Typical misapplications include exposure to excessive voltage, current or temperature. If the dielectric layer of the capacitor is damaged by misapplication the electrical energy of the circuit can be released as heat, which may damage the circuit board and other components as well.

If potential for misapplication exists, it is recommended that precautions be taken to protect personnel and equipment during initial application of voltage. Commonly used precautions include shielding of personnel and sensing for excessive power drain during board testing.

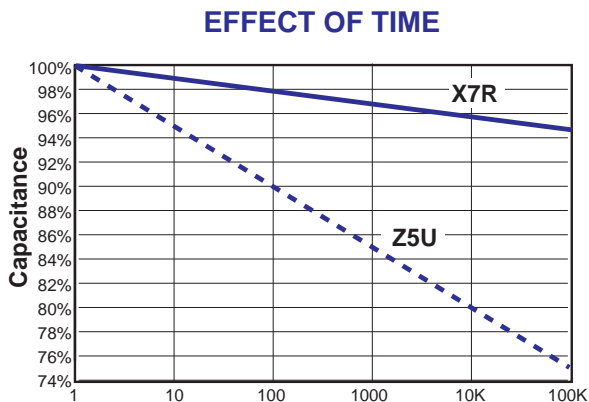
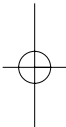

Figure 13. Typical Aging Rates for X7R & Z5U

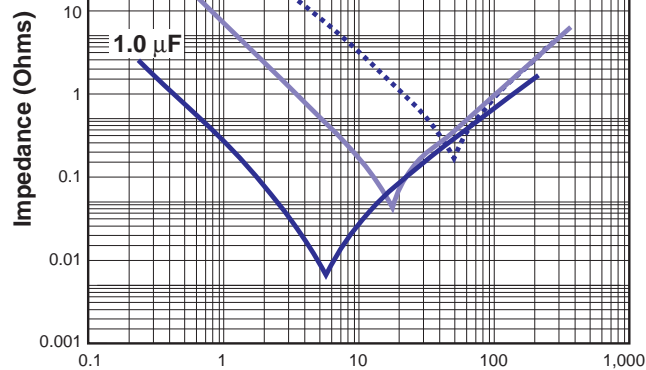

Figure 11. Impedance vs Frequency for X7R Dielectric

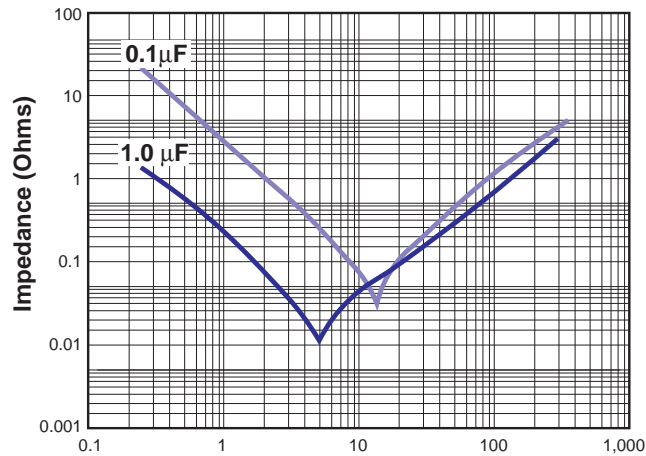
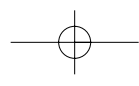

Figure 12. Impedance vs Frequency for Z5U Dielectric



Phone: 33-1-4512-5320
Fax: 33-1-4687-4087

KEMET Electronics GmbH
Postfach 1380
D85531 Haar/Munich
Germany
Phone: 49-89-456-4200
Fax: 49-89-460-4117

KEMET Electronics S.A.
1-3, Avenue de la Paix
P.O.B. 76
CH-1211 Geneva 20,
Switzerland
Phone: 41-22-715-0100
Fax: 41-22-715-0170

Phone: 44-1279-75-7343
Fax: 44-1279-75-7188

Aviv Electronics Ltd.
Hayetzira St. No. 4
P.O. Box 2433
Ra'anana, 43100
Israel
Phone: 972-9-748-3232
Fax: 972-9-741-6510

Arrow Altech Distribution PTY LTD
53 - 57 Yaldwyn Road
Hughes Ext.
Jet Park 1459
South Africa
Phone: 27-11-923-9600
Fax: 27-11-923-9884

Asia Locations

KEMET Electronics (Shanghai) Co., Ltd.
2/F, No. 7 Bldg., 330 Xiya Rd.
Waigaoqiao Free Trade Zone
Pudong, Shanghai 200137, China
Phone: 86-21-5046-0983
Fax: 86-21-5046-0981

KEMET Electronics Asia Ltd.
(Beijing Representative Office)
Suite 1512, 15/F, Lucky Tower B
3 Dong San Huan Bei Rd., Chao Yang District
Beijing, 100027, China
Phone: 86-10-6462-0173
Fax: 86-10-6461-5707

KEMET Electronics Asia Ltd.
4A Chuan Hing Industrial Bldg.
14 Wang Tai Road
Kowloon Bay, Hong Kong
Phone: 852-2305-1168
Fax: 852-2759-0345

KEMET Electronics Marketing PTE Ltd.
8-2-04, Sunny Point Kompleks, Jalan
Batu Uban, 11700 Penang
Penang, Malaysia
Phone: 60-4-6595200
Fax: 60-4-6595220

KEMET Electronics Marketing PTE Ltd.
101 Thomson Road, #23-03
United Square
Singapore, 307591, Singapore
Phone: 65-353-6636
Fax: 65-353-6656

KEMET Electronics Corporation
Taiwan Branch, 3-4F, No. 148, Section 4
Chung-Hsaio E. Rd.
Taipei, Taiwan ROC
Phone: 886-2-27528585
Fax: 886-2-27213129

Bestrade Limited
28/3 Charoren Vian Road Silcom
Bangrak, Bangkok 10500, Thailand
Phone: 662-235-1613
Fax: 662-237-7132

Crusader Electronics Pty. Ltd.
Unit 3, 92 Bryant Street
Padstow, NSW 2211, Australia
Phone: 02-9792-3922
Fax: 02-9792-1446

Electronic Enterprises Private Ltd.
Post Bag No. 6367
Unit 216 Regal Industrial Estate
Acharya Donda Marg., Sewri
Bombay 400 015, India
Phone: 91-22-413-7096
Fax: 91-22-413-3341

Unicom International Corporation
702 Shinhwa Bldg., Mapo-Gu
Seoul, 121050, Korea
Phone: 82-2712-5821
Fax: 82-2712-5823

NOTICE: Place 011 in front of the above Phone and Fax numbers for Europe and Asia, when dialing from a United States exchange.
Note: KEMET reserves the right to modify minor details of internal and external construction at any time in the interest of product improvement.
KEMET does not assume any responsibility for infringement that might result from the use of KEMET Capacitors in potential circuit designs.
"KEMET" is a registered trademark of KEMET Electronics Corporation.