

N-CHANNEL SILICON POWER MOS-FET

■ Features

- High speed switching
- Low on-resistance
- No secondary breakdown
- Low driving power
- Avalanche-proof

■ Applications

- Switching regulators
- UPS (Uninterruptible Power Supply)
- DC-DC converters

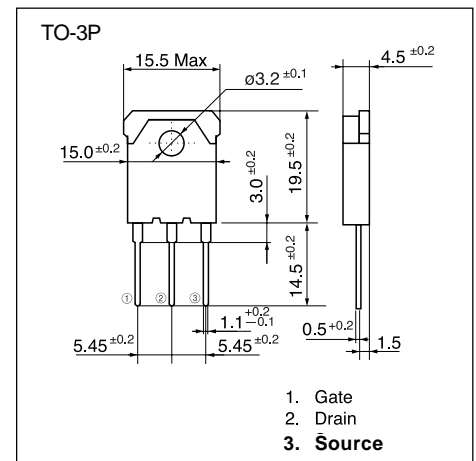

■ Maximum ratings and characteristic Absolute maximum ratings

● (T_c=25°C unless otherwise specified)

Item	Symbol	Rating	Unit
Drain-source voltage	V _{DS}	60	V
Continuous drain current	I _D	±80	A
Pulsed drain current	I _{D(puls)}	±320	A
Gate-source voltage	V _{GS}	±30	V
Maximum Avalanche Energy	E _{AV} *1	972.3	mJ
Max. power dissipation	P _D	125	W
Operating and storage temperature range	T _{ch} T _{stg}	+150 -55 to +150	°C

*1 L=0.203mH, V_{cc}=24V

■ Equivalent circuit schematic

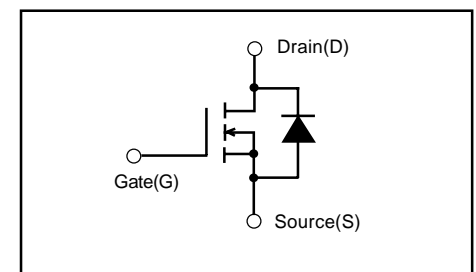

● Electrical characteristics (T_c =25°C unless otherwise specified)

Item	Symbol	Test Conditions	Min.	Typ.	Max.	Units
Drain-source breakdown voltage	BV _{DSS}	I _D =1mA V _{GS} =0V	60			V
Gate threshold voltage	V _{GS(th)}	I _D =10mA V _{DS} =V _{GS}	2.5	3.0	3.5	V
Zero gate voltage drain current	I _{DSS}	V _{DS} =60V V _{GS} =0V	T _{ch} =25°C	10	500	μA
			T _{ch} =125°C	0.2	1.0	mA
Gate-source leakage current	I _{GSS}	V _{GS} =±30V V _{DS} =0V		10	100	nA
Drain-source on-state resistance	R _{DS(on)}	I _D =40A V _{GS} =10V		9.5	12	mΩ
Forward transconductance	g _{fs}	I _D =40A V _{DS} =25V	20	40		S
Input capacitance	C _{iss}	V _{DS} =25V		3100	4650	pF
Output capacitance	C _{oss}	V _{GS} =0V		1300	1950	pF
Reverse transfer capacitance	C _{rss}	f=1MHz		350	530	pF
Turn-on time t _{on}	t _{d(on)} t _r	V _{CC} =30V I _D =80A V _{GS} =10V		20	30	ns
				85	120	
Turn-off time t _{off}	t _{d(off)} t _f	R _{GS} =10 Ω		88	130	ns
				65	120	
Avalanche capability	I _{AV}	L=100 μH T _{ch} =25°C	80			A
Diode forward on-voltage	V _{SD}	I _F =50A V _{GS} =0V T _{ch} =25°C		1.0	1.5	V
Reverse recovery time	t _{rr}	I _F =50A V _{GS} =0V		70		ns
Reverse recovery charge	Q _{rr}	-di/dt=100A/μs T _{ch} =25°C		0.13		μC

● Thermal characteristics

Item	Symbol	Test Conditions	Min.	Typ.	Max.	Units
Thermal resistance	R _{th(ch-c)}	channel to case			1.0	°C/W
	R _{th(ch-a)}	channel to ambient			35.0	°C/W

Characteristics

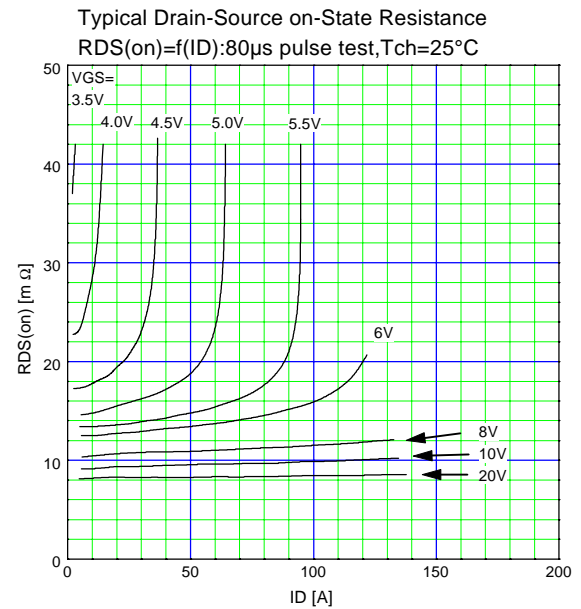
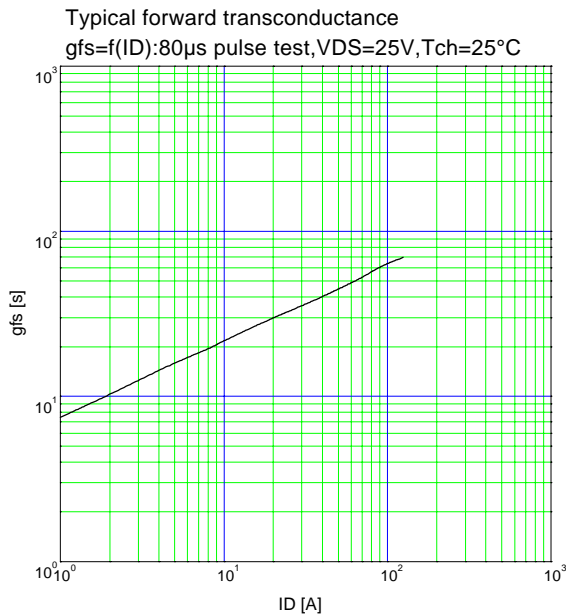
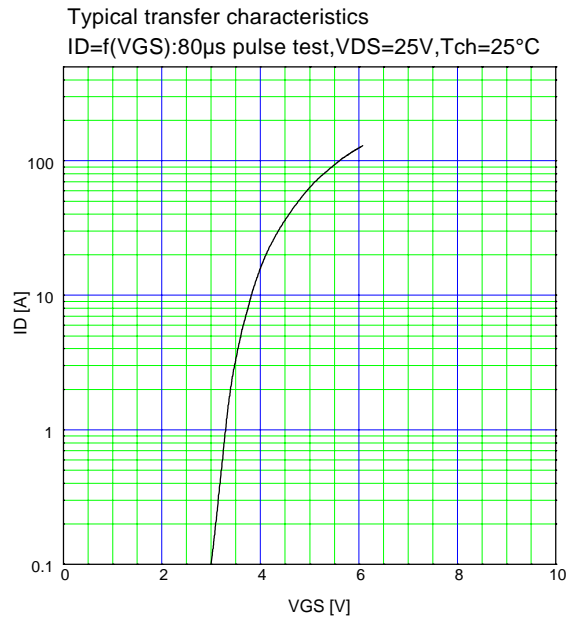
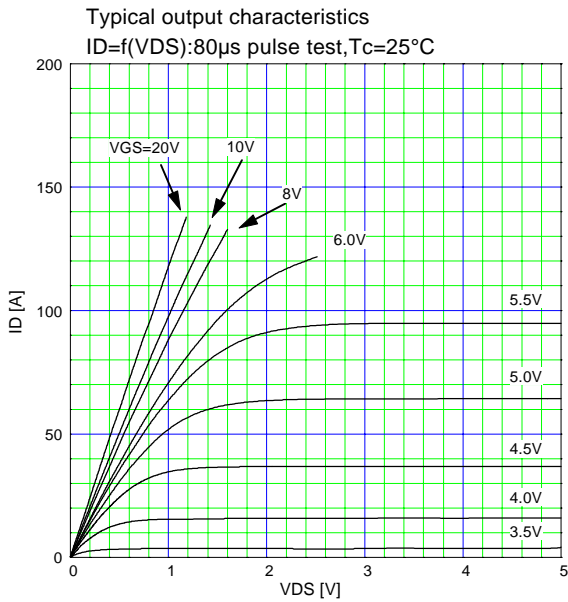
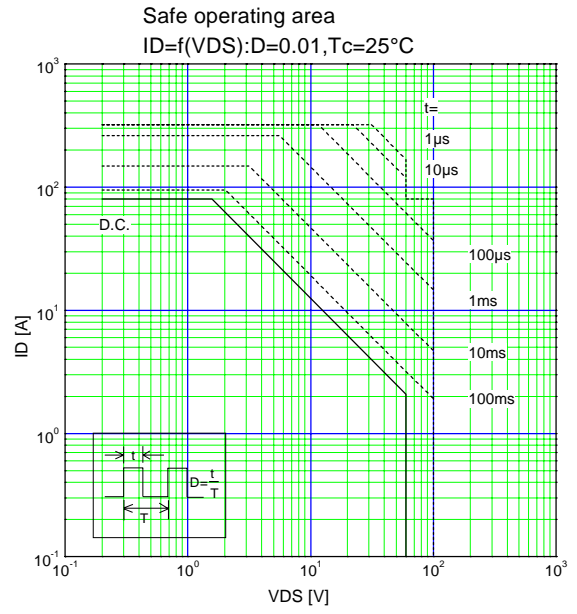
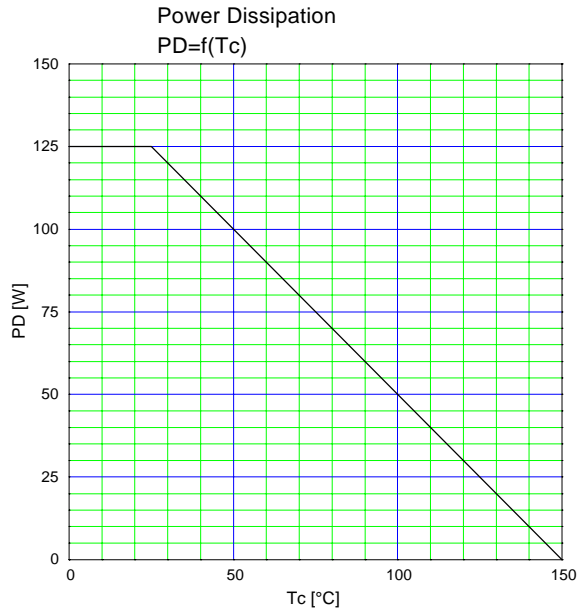

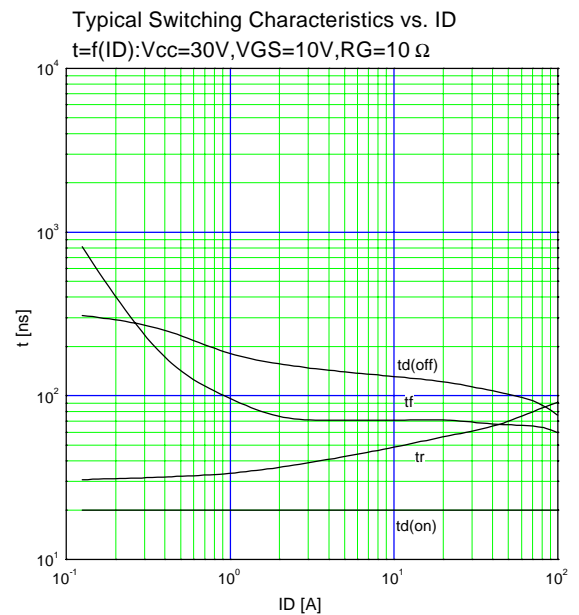
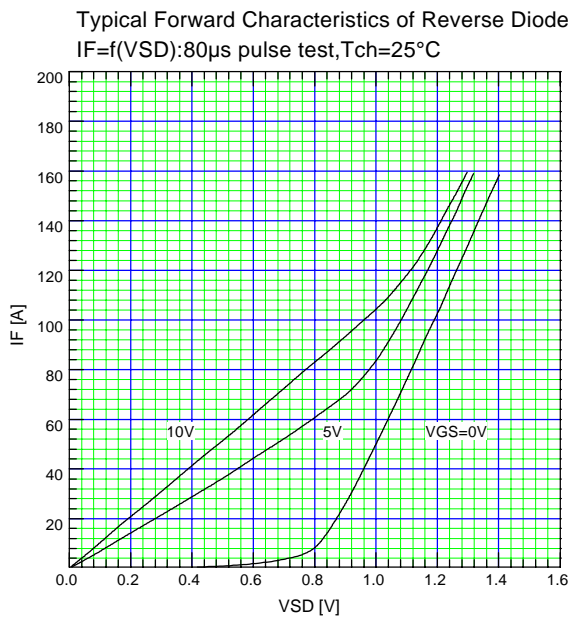
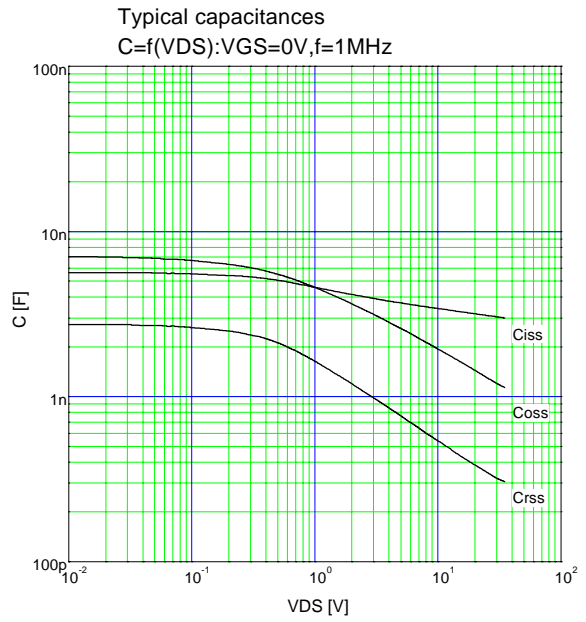
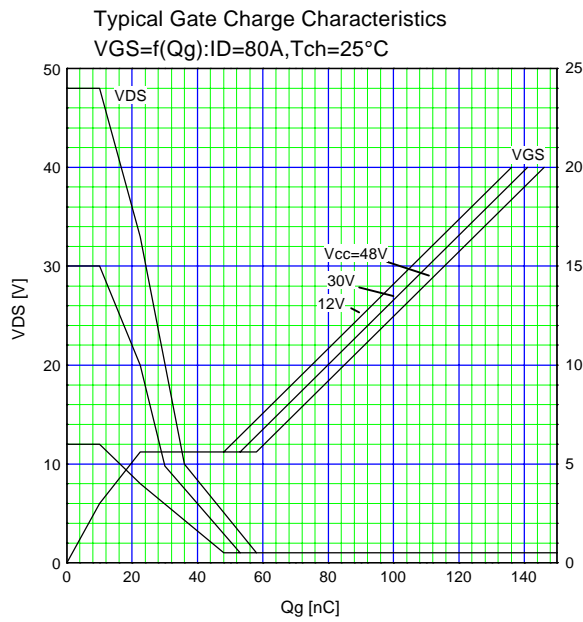
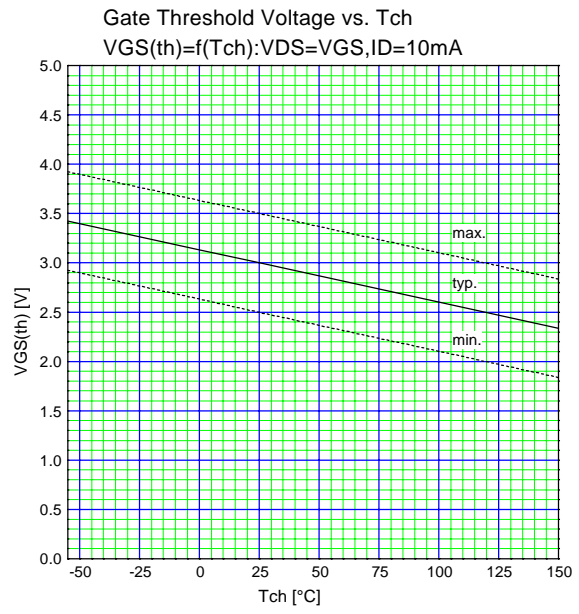
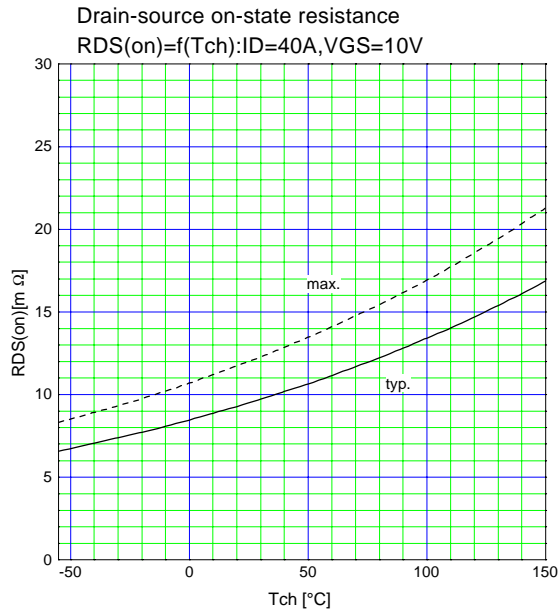

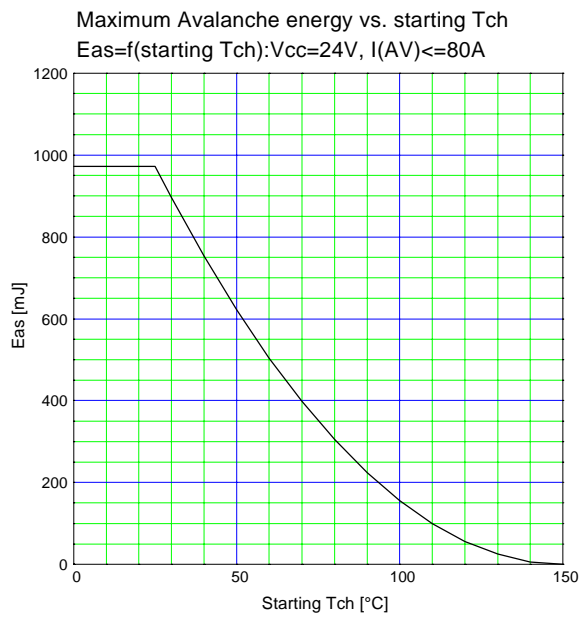
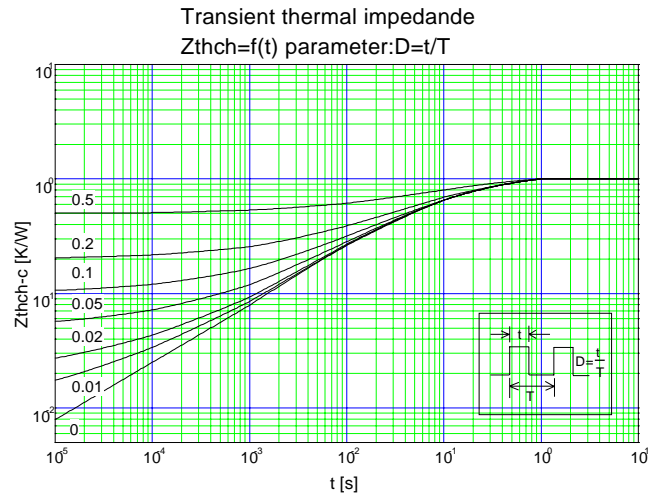
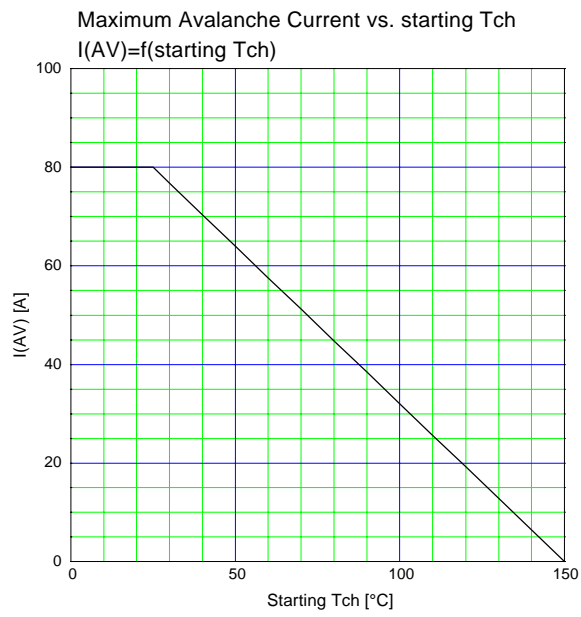

Copyright © Each Manufacturing Company.

All Datasheets cannot be modified without permission.

This datasheet has been download from :

www.AllDataSheet.com

100% Free DataSheet Search Site.

Free Download.

No Register.

Fast Search System.

www.AllDataSheet.com