



CMOS, Rail-to-Rail, I/O OPERATIONAL AMPLIFIERS

FEATURES

- RAIL-TO-RAIL INPUT AND OUTPUT
- WIDE SUPPLY RANGE:
Single Supply: 4V to 12V
Dual Supplies: ± 2 to ± 6
- LOW QUIESCENT CURRENT: 160 μ A
- FULL-SCALE CMRR: 90dB
- LOW OFFSET: 160 μ V
- HIGH SPEED:
OPA703: 1MHz, 0.6V/ μ s
OPA704: 3MHz, 3V/ μ s
- *Micro*SIZE PACKAGES:
SOT23-5, MSOP-8, TSSOP-14
- LOW INPUT BIAS CURRENT: 1pA

APPLICATIONS

- AUTOMOTIVE APPLICATIONS:
Audio, Sensor Applications, Security Systems
- PORTABLE EQUIPMENT
- ACTIVE FILTERS
- TRANSDUCER AMPLIFIER
- TEST EQUIPMENT
- DATA ACQUISITION

DESCRIPTION

The OPA703 and OPA704 series op amps are optimized for applications requiring rail-to-rail input and output swing. Single, dual, and quad versions are offered in a variety of packages. While the quiescent current is less than 200 μ A per amplifier, the OPA703 still offers excellent dynamic performance (1MHz GBW and 0.6V/ μ s SR) and unity-gain stability. The OPA704 is optimized for gains of 5 or greater and provides 3MHz GBW and 3V/ μ s slew rate.

The OPA703 and OPA704 series are fully specified and guaranteed over the supply range of ± 2 V to ± 6 V. Input swing extends 300mV beyond the rail and the output swings to within 40mV of the rail.

The single versions (OPA703 and OPA704) are available in the *Micro*SIZE SOT23-5 and in the standard SO-8 surface-mount, as well as the DIP-8 packages. Dual versions (OPA2703 and OPA2704) are available in the MSOP-8, SO-8, and DIP-8 packages. The quad OPA4703 and OPA4704 are available in the TSSOP-14 and SO-14 packages. All are specified for operation from -40° C to $+85^{\circ}$ C.



Please be aware that an important notice concerning availability, standard warranty, and use in critical applications of Texas Instruments semiconductor products and disclaimers thereto appears at the end of this data sheet.

ABSOLUTE MAXIMUM RATINGS⁽¹⁾

Supply Voltage, V+ to V-.....	13.2V
Signal Input Terminals, Voltage ⁽²⁾ (V-) -0.3V to (V+) +0.3V	
Current ⁽²⁾	10mA
Output Short-Circuit ⁽³⁾	Continuous
Operating Temperature.....	-55°C to +125°C
Storage Temperature.....	-65°C to +150°C
Junction Temperature.....	+150°C
Lead Temperature (soldering, 10s).....	+300°C

NOTES: (1) Stresses above these ratings may cause permanent damage. Exposure to absolute maximum conditions for extended periods may degrade device reliability. (2) Input terminals are diode-clamped to the power supply rails. Input signals that can swing more than 0.3V beyond the supply rails should be current-limited to 10mA or less. (3) Short-circuit to ground, one amplifier per package.



ELECTROSTATIC DISCHARGE SENSITIVITY

This integrated circuit can be damaged by ESD. Texas Instruments recommends that all integrated circuits be handled with appropriate precautions. Failure to observe proper handling and installation procedures can cause damage.

ESD damage can range from subtle performance degradation to complete device failure. Precision integrated circuits may be more susceptible to damage because very small parametric changes could cause the device not to meet its published specifications.

PACKAGE/ORDERING INFORMATION

PRODUCT	DESCRIPTION	MINIMUM RECOMMENDED GAIN	PACKAGE	PACKAGE DRAWING NUMBER	PACKAGE MARKING	ORDERING NUMBER ⁽¹⁾	TRANSPORT MEDIA
OPA703NA "	Single, GBW = 1MHz "	1 "	SOT23-5 "	331 "	A03 "	OPA703NA/250 OPA703NA/3K	Tape and Reel Tape and Reel
OPA703UA "	Single, GBW = 1MHz "	1 "	SO-8 "	182 "	OPA703UA "	OPA703UA OPA703UA/2K5	Rails Tape and Reel
OPA703PA "	Single, GBW = 1MHz "	1 "	DIP-8 "	006 "	OPA703PA "	OPA703PA "	Rails Rails
OPA2703EA "	Dual, GBW = 1MHz "	1 "	MSOP-8 "	337 "	B03 "	OPA2703EA/250 OPA2703EA/2K5	Tape and Reel Tape and Reel
OPA2703UA "	Dual, GBW = 1MHz "	1 "	SO-8 "	182 "	OPA2703UA "	OPA2703UA OPA2703UA/2K5	Rails Tape and Reel
OPA2703PA "	Dual, GBW = 1MHz "	1 "	DIP-8 "	006 "	OPA2703PA "	OPA2703PA "	Rails Rails
OPA4703EA "	Quad, GBW = 1MHz "	1 "	TSSOP-14 "	357 "	OPA4703EA "	OPA4703EA/250 OPA4703EA/2K5	Tape and Reel Tape and Reel
OPA4703UA "	Quad, GBW = 1MHz "	1 "	SO-14 "	235 "	OPA4703UA "	OPA4703UA OPA4703UA/2K5	Rails Tape and Reel
OPA704NA "	Single, GBW = 5MHz "	5 "	SOT23-5 "	331 "	A04 "	OPA704NA/250 OPA704NA/3K	Tape and Reel Tape and Reel
OPA704UA "	Single, GBW = 5MHz "	5 "	SO-8 "	182 "	OPA704UA "	OPA704UA OPA704UA/2K5	Tape and Reel Tape and Reel
OPA704PA "	Single, GBW = 5MHz "	5 "	DIP-8 "	006 "	OPA704PA "	OPA704PA "	Rails Rails
OPA2704EA "	Dual, GBW = 5MHz "	5 "	MSOP-8 "	337 "	B04 "	OPA2703EA/250 OPA2703EA/2K5	Tape and Reel Tape and Reel
OPA2704UA "	Dual, GBW = 5MHz "	5 "	SO-8 "	182 "	OPA2704UA "	OPA2704UA OPA2704UA/2K5	Rails Tape and Reel
OPA2704PA "	Dual, GBW = 5MHz "	5 "	DIP-8 "	006 "	OPA2704PA "	OPA2704PA "	Rails Rails
OPA4704EA "	Quad, GBW = 5MHz "	5 "	TSSOP-14 "	357 "	OPA4704EA "	OPA4704EA/250 OPA4704EA/2K5	Tape and Reel Tape and Reel
OPA4704UA "	Quad, GBW = 5MHz "	5 "	SO-14 "	235 "	OPA4704UA "	OPA4704UA OPA4704UA/2K5	Rails Tape and Reel

NOTE: (1) Models with a slash (/) are available only in Tape and Reel in the quantities indicated (e.g., /3K indicates 3000 devices per reel). Ordering 3000 pieces of "OPA703NA/3K" will get a single 3000-piece Tape and Reel.

OPA703 ELECTRICAL CHARACTERISTICS: $V_S = 4V$ to $12V$

Boldface limits apply over the specified temperature range, $T_A = -40^\circ\text{C}$ to $+85^\circ\text{C}$

At $T_A = +25^\circ\text{C}$, $R_L = 20\text{k}\Omega$ connected to $V_S/2$ and $V_{OUT} = V_S/2$, unless otherwise noted.

PARAMETER	CONDITION	OPA703NA, UA, PA OPA2703EA, UA, PA OPA4703EA, UA			UNITS
		MIN	TYP	MAX	
OFFSET VOLTAGE Input Offset Voltage Drift vs Power Supply Over Temperature Channel Separation, dc $f = 1\text{kHz}$	V_{OS} dV_{OS}/dT PSRR $V_S = \pm 5V, V_{CM} = 0V$ $T_A = -40^\circ\text{C}$ to $+85^\circ\text{C}$ $V_S = \pm 2V$ to $\pm 6V, V_{CM} = 0V$ $V_S = \pm 2V$ to $\pm 6V, V_{CM} = 0V$ $R_L = 20\text{k}\Omega$		± 160 ± 4 20 1 98	± 750 100 200	μV $\mu\text{V}/^\circ\text{C}$ $\mu\text{V}/\text{V}$ $\mu\text{V}/\text{V}$ $\mu\text{V}/\text{V}$ dB
INPUT VOLTAGE RANGE Common-Mode Voltage Range Common-Mode Rejection Ratio over Temperature over Temperature	V_{CM} CMRR $V_S = \pm 5V, (V-) - 0.3V < V_{CM} < (V+) + 0.3V$ $V_S = \pm 5V, (V-) < V_{CM} < (V+)$ $V_S = \pm 5V, (V-) - 0.3V < V_{CM} < (V+) - 2V$ $V_S = \pm 5V, (V-) < V_{CM} < (V+) - 2V$	$(V-) - 0.3$ 70 80 74	90 96	$(V+) + 0.3$ dB dB dB	V dB dB dB
INPUT BIAS CURRENT Input Bias Current Input Offset Current	I_B I_{OS} $V_S = \pm 5V, V_{CM} = 0V$ $V_S = \pm 5V, V_{CM} = 0V$		± 1 ± 0.5	± 10 ± 10	pA pA
INPUT IMPEDANCE Differential Common-Mode			$4 \cdot 10^9 \parallel 4$ $5 \cdot 10^{12} \parallel 4$		$\Omega \parallel \text{pF}$ $\Omega \parallel \text{pF}$
NOISE Input Voltage Noise, $f = 0.1\text{Hz}$ to 10Hz Input Voltage Noise Density, $f = 1\text{kHz}$ Current Noise Density, $f = 1\text{kHz}$	e_n i_n $V_S = \pm 5V, V_{CM} = 0V$ $V_S = \pm 5V, V_{CM} = 0V$ $V_S = \pm 5V, V_{CM} = 0V$		6 45 2.5		$\mu\text{Vp-p}$ $\text{nV}/\sqrt{\text{Hz}}$ $\text{fA}/\sqrt{\text{Hz}}$
OPEN-LOOP GAIN Open-Loop Voltage Gain over Temperature over Temperature	A_{OL} $R_L = 100\text{k}\Omega, (V-) + 0.1V < V_O < (V+) - 0.1V$ $R_L = 20\text{k}\Omega, (V-) + 0.075V < V_O < (V+) - 0.075V$ $R_L = 20\text{k}\Omega, (V-) + 0.075V < V_O < (V+) - 0.075V$ $R_L = 5\text{k}\Omega, (V-) + 0.15V < V_O < (V+) - 0.15V$ $R_L = 5\text{k}\Omega, (V-) + 0.15V < V_O < (V+) - 0.15V$	100 96 100 96	120 110 110		dB dB dB dB
OUTPUT Voltage Output Swing from Rail over Temperature over Temperature Output Current Short-Circuit Current Capacitive Load Drive	I_{OUT} I_{SC} C_{LOAD} $R_L = 100\text{k}\Omega, A_{OL} > 80\text{dB}$ $R_L = 20\text{k}\Omega, A_{OL} > 100\text{dB}$ $R_L = 20\text{k}\Omega, A_{OL} > 96\text{dB}$ $R_L = 5\text{k}\Omega, A_{OL} > 100\text{dB}$ $R_L = 5\text{k}\Omega, A_{OL} > 96\text{dB}$ $ V_S - V_{OUT} < 1V$		40 ± 10 ± 40	75 75 150 150	mV mV mV mV mV mA mA
FREQUENCY RESPONSE Gain-Bandwidth Product Slew Rate Settling Time, 0.1% 0.01% Overload Recovery Time Total Harmonic Distortion + Noise	GBW SR t_s THD+N $C_L = 100\text{pF}$ $G = +1$ $V_S = \pm 5V, G = +1$ $V_S = \pm 5V, 5V$ Step, $G = +1$ $V_S = \pm 5V, 5V$ Step, $G = +1$ $V_{IN} \cdot \text{Gain} = V_S$ $V_S = \pm 5V, V_O = 3V_{p-p}, G = +1, f = 1\text{kHz}$		1 0.6 15 20 3 0.02		MHz V/ μs μs μs μs %
POWER SUPPLY Specified Voltage Range, Single Supply Specified Voltage Range, Dual Supplies Operating Voltage Range Quiescent Current (per amplifier) over Temperature	V_S V_S I_Q $I_Q = 0$	4 ± 2	3.6 to 12 160	12 ± 6	V V V μA μA
TEMPERATURE RANGE Specified Range Operating Range Storage Range Thermal Resistance SOT23-5 Surface-Mount MSOP-8 Surface-Mount TSSOP-14 Surface-Mount SO-8 Surface Mount SO-14 Surface Mount DIP-8	θ_{JA}	-40 -55 -65		85 125 150	$^\circ\text{C}$ $^\circ\text{C}$ $^\circ\text{C}$ $^\circ\text{C}/\text{W}$ $^\circ\text{C}/\text{W}$ $^\circ\text{C}/\text{W}$ $^\circ\text{C}/\text{W}$ $^\circ\text{C}/\text{W}$ $^\circ\text{C}/\text{W}$ $^\circ\text{C}/\text{W}$

OPA704 ELECTRICAL CHARACTERISTICS: $V_S = 4V$ to $12V$

Boldface limits apply over the specified temperature range, $T_A = -40^\circ\text{C}$ to $+85^\circ\text{C}$

At $T_A = +25^\circ\text{C}$, $R_L = 20\text{k}\Omega$ connected to $V_S/2$ and $V_{OUT} = V_S/2$, unless otherwise noted.

PARAMETER	CONDITION	OPA704NA, UA, PA OPA2704EA, UA, PA OPA4704EA, UA			UNITS
		MIN	TYP	MAX	
OFFSET VOLTAGE Input Offset Voltage Drift vs Power Supply Over Temperature Channel Separation, dc $f = 1\text{kHz}$	V_{OS} dV_{OS}/dT PSRR $V_S = \pm 5V, V_{CM} = 0V$ $T_A = -40^\circ\text{C}$ to $+85^\circ\text{C}$ $V_S = \pm 2V$ to $\pm 6V, V_{CM} = 0V$ $V_S = \pm 2V$ to $\pm 6V, V_{CM} = 0V$ $R_L = 20\text{k}\Omega$		± 160 ± 4 20 1 98	± 750 100 200	μV $\mu\text{V}/^\circ\text{C}$ $\mu\text{V}/\text{V}$ $\mu\text{V}/\text{V}$ $\mu\text{V}/\text{V}$ dB
INPUT VOLTAGE RANGE Common-Mode Voltage Range Common-Mode Rejection Ratio over Temperature over Temperature	V_{CM} CMRR $V_S = \pm 5V, (V-) - 0.3V < V_{CM} < (V+) + 0.3V$ $V_S = \pm 5V, (V-) < V_{CM} < (V+)$ $V_S = \pm 5V, (V-) - 0.3V < V_{CM} < (V+) - 2V$ $V_S = \pm 5V, (V-) < V_{CM} < (V+) - 2V$	$(V-) - 0.3$ 70 80 74	90 96	$(V+) + 0.3$	V dB dB dB
INPUT BIAS CURRENT Input Bias Current Input Offset Current	I_B I_{OS} $V_S = \pm 5V, V_{CM} = 0V$ $V_S = \pm 5V, V_{CM} = 0V$		± 1 ± 0.5	± 10 ± 10	pA pA
INPUT IMPEDANCE Differential Common-Mode			$4 \cdot 10^9 \parallel 4$ $5 \cdot 10^{12} \parallel 4$		$\Omega \parallel \text{pF}$ $\Omega \parallel \text{pF}$
NOISE Input Voltage Noise, $f = 0.1\text{Hz}$ to 10Hz Input Voltage Noise Density, $f = 1\text{kHz}$ Current Noise Density, $f = 1\text{kHz}$	e_n e_n i_n $V_S = \pm 5V, V_{CM} = 0V$ $V_S = \pm 5V, V_{CM} = 0V$ $V_S = \pm 5V, V_{CM} = 0V$		6 45 2.5		$\mu\text{Vp-p}$ $\text{nV}/\sqrt{\text{Hz}}$ $\text{fA}/\sqrt{\text{Hz}}$
OPEN-LOOP GAIN Open-Loop Voltage Gain over Temperature over Temperature	A_{OL} $R_L = 100\text{k}\Omega, (V-) + 0.1V < V_O < (V+) - 0.1V$ $R_L = 20\text{k}\Omega, (V-) + 0.075V < V_O < (V+) - 0.075V$ $R_L = 20\text{k}\Omega, (V-) + 0.075V < V_O < (V+) - 0.075V$ $R_L = 5\text{k}\Omega, (V-) + 0.15V < V_O < (V+) - 0.15V$ $R_L = 5\text{k}\Omega, (V-) + 0.15V < V_O < (V+) - 0.15V$	100 96 100 96	120 110 110		dB dB dB dB
OUTPUT Voltage Output Swing from Rail over Temperature over Temperature Output Current Short-Circuit Current Capacitive Load Drive	I_{OUT} I_{SC} C_{LOAD} $R_L = 100\text{k}\Omega, A_{OL} > 80\text{dB}$ $R_L = 20\text{k}\Omega, A_{OL} > 100\text{dB}$ $R_L = 20\text{k}\Omega, A_{OL} > 96\text{dB}$ $R_L = 5\text{k}\Omega, A_{OL} > 100\text{dB}$ $R_L = 5\text{k}\Omega, A_{OL} > 96\text{dB}$ $ V_S - V_{OUT} < 1V$		40 ± 10 ± 40	75 75 150 150	mV mV mV mV mA mA
FREQUENCY RESPONSE Gain-Bandwidth Product Slew Rate Settling Time, 0.1% 0.01% Overload Recovery Time Total Harmonic Distortion + Noise	GBW SR t_S THD+N $C_L = 100\text{pF}$ $G = +5$ $V_S = \pm 5V, G = +5$ $V_S = \pm 5V, 5V$ Step, $G = +5$ $V_S = \pm 5V, 5V$ Step, $G = +5$ $V_{IN} \cdot \text{Gain} = V_S$ $V_S = \pm 5V, V_O = 3V_{p-p}, G = +5, f = 1\text{kHz}$		3 3 18 21 0.6 0.025		MHz V/ μs μs μs μs %
POWER SUPPLY Specified Voltage Range, Single Supply Specified Voltage Range, Dual Supplies Operating Voltage Range Quiescent Current (per amplifier) over Temperature	V_S V_S I_Q $I_Q = 0$	4 ± 2	 3.6 to 12 160	12 ± 6 200 300	V V V μA μA
TEMPERATURE RANGE Specified Range Operating Range Storage Range Thermal Resistance SOT23-5 Surface-Mount MSOP-8 Surface-Mount TSSOP-14 Surface-Mount SO-8 Surface Mount SO-14 Surface Mount DIP-8	θ_{JA}	-40 -55 -65		85 125 150 200 150 100 150 100 100	$^\circ\text{C}$ $^\circ\text{C}$ $^\circ\text{C}$ $^\circ\text{C}/\text{W}$ $^\circ\text{C}/\text{W}$ $^\circ\text{C}/\text{W}$ $^\circ\text{C}/\text{W}$ $^\circ\text{C}/\text{W}$ $^\circ\text{C}/\text{W}$ $^\circ\text{C}/\text{W}$

TYPICAL CHARACTERISTICS

At $T_A = +25^\circ\text{C}$, $V_S = \pm 5\text{V}$, and $R_L = 20\text{k}\Omega$, unless otherwise noted.

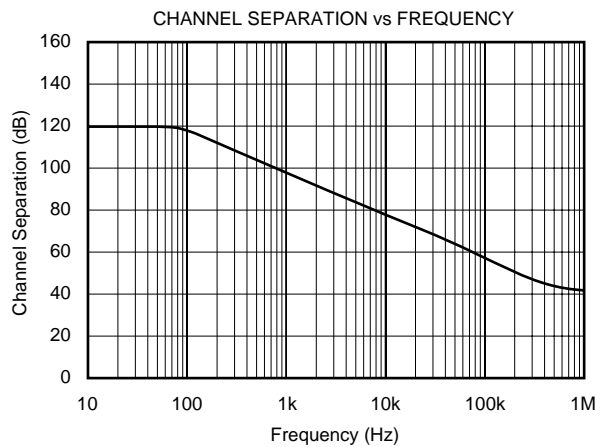
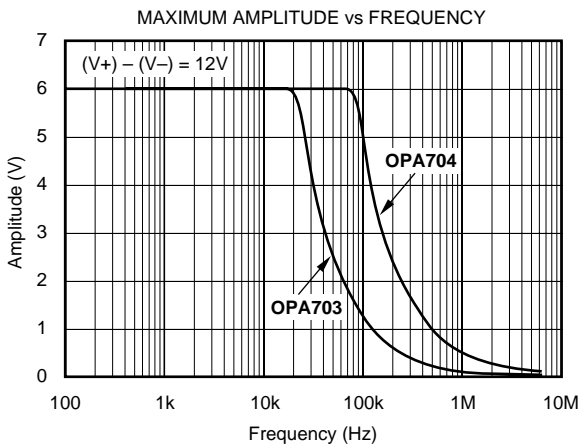
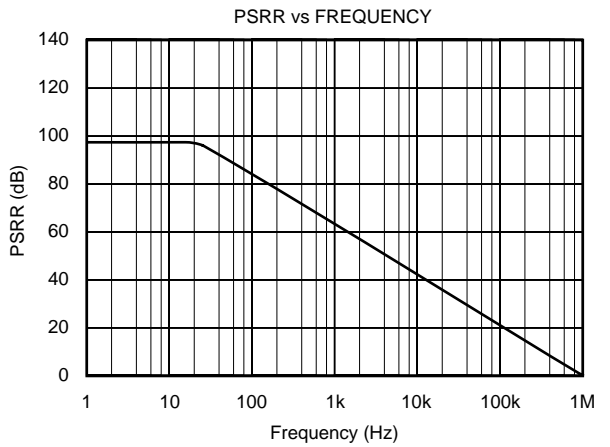
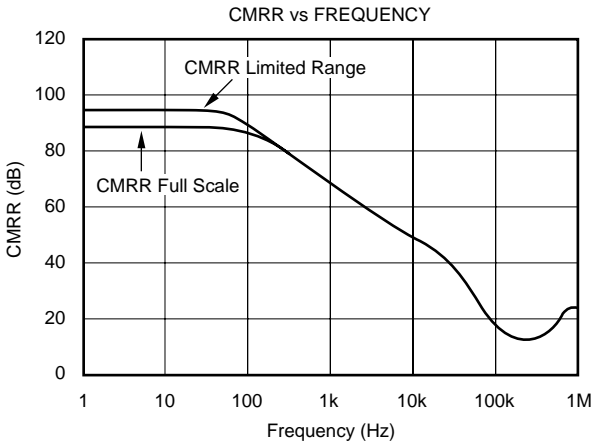
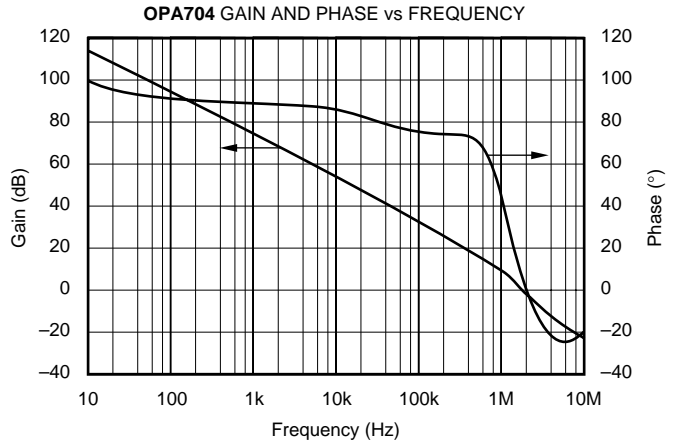

TYPICAL CHARACTERISTICS (Cont.)

At $T_A = +25^\circ\text{C}$, $V_S = \pm 5\text{V}$, and $R_L = 20\text{k}\Omega$, unless otherwise noted.



TYPICAL CHARACTERISTICS (Cont.)

At $T_A = +25^\circ\text{C}$, $V_S = \pm 5\text{V}$, and $R_L = 20\text{k}\Omega$, unless otherwise noted.

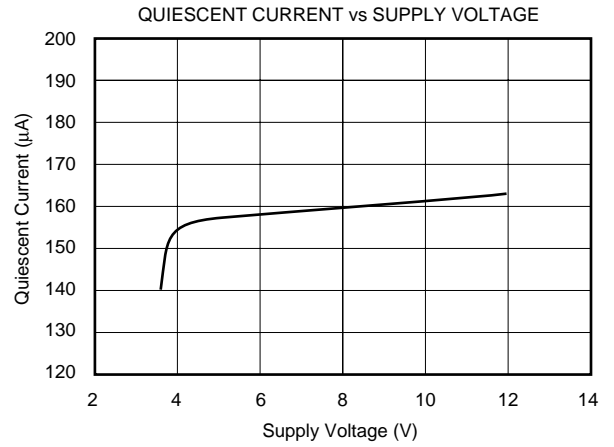
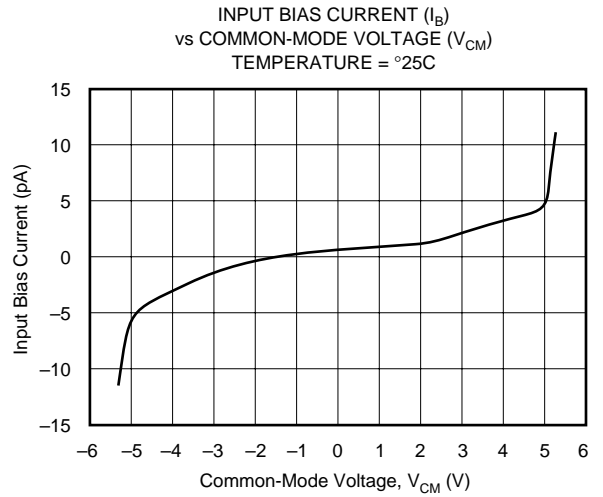

TYPICAL CHARACTERISTICS (Cont.)

At $T_A = +25^\circ\text{C}$, $V_S = \pm 5\text{V}$, and $R_L = 20\text{k}\Omega$, unless otherwise noted.



TYPICAL CHARACTERISTICS (Cont.)

At $T_A = +25^\circ\text{C}$, $V_S = \pm 5\text{V}$, and $R_L = 20\text{k}\Omega$, unless otherwise noted.

OPA703 SMALL SIGNAL STEP RESPONSE
($G = +1\text{V/V}$, $R_L = 20\text{k}\Omega$, $C_L = 100\text{pF}$)

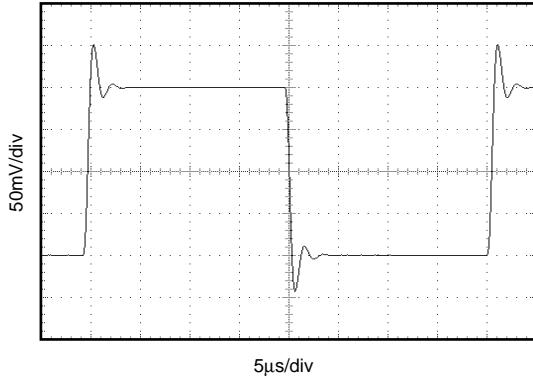

OPA704 SMALL SIGNAL STEP RESPONSE
($G = +5\text{V/V}$, $C_F = 3\text{pF}$, $R_F = 100\text{k}\Omega$,
 $C_L = 100\text{pF}$, $R_L = 20\text{k}\Omega$)

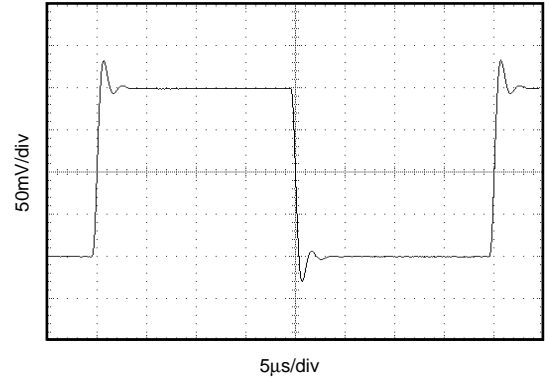

OPA703 LARGE SIGNAL STEP RESPONSE
($G = +1\text{V/V}$, $R_L = 20\text{k}\Omega$, $C_L = 100\text{pF}$)

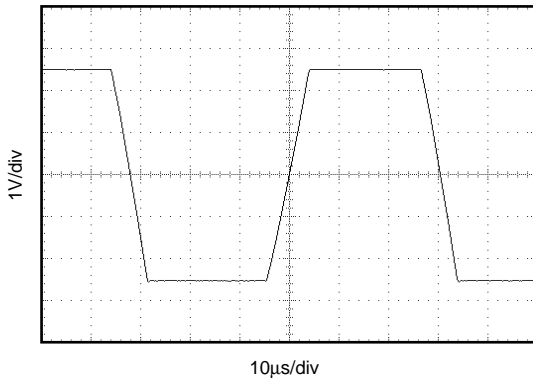

OPA704 LARGE SIGNAL STEP RESPONSE
($G = +5\text{V/V}$, $R_L = 20\text{k}\Omega$, $C_F = 3\text{pF}$, $C_L = 100\text{pF}$)

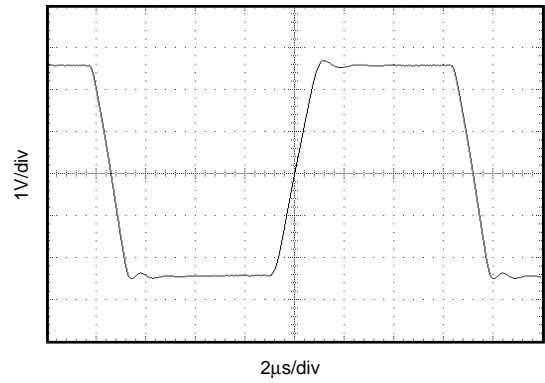

APPLICATIONS INFORMATION

OPA703 and OPA704 series op amps can operate on 160 μ A quiescent current from a single (or split) supply in the range of 4V to 12V (± 2 V to ± 6 V), making them highly versatile and easy to use. The OPA703 is unity-gain stable and offers 1MHz bandwidth and 0.6V/ μ s slew rate. The OPA704 is optimized for gains of 5 or greater with a 3MHz bandwidth and 3V/ μ s slew rate.

Rail-to-rail input and output swing helps maintain dynamic range, especially in low supply applications. Figure 1 shows the input and output waveforms for the OPA703 in unity-gain configuration. Operation is from a ± 5 V supply with a 100k Ω load connected to $V_S/2$. The input is a 10Vp-p sinusoid. Output voltage is approximately 10Vp-p.



FIGURE 1. Rail-to-Rail Input and Output.

Power-supply pins should be bypassed with 1000pF ceramic capacitors in parallel with 1 μ F tantalum capacitors.

OPERATING VOLTAGE

OPA703 and OPA704 series op amps are fully specified and guaranteed from +4V to +12V over a temperature range of -40°C to $+85^{\circ}\text{C}$. Parameters that vary significantly with operating voltages or temperature are shown in the Typical Performance Curves.

RAIL-TO-RAIL INPUT

The input common-mode voltage range of the OPA703 series extends 300mV beyond the supply rails at room temperature. This is achieved with a complementary input stage—an N-channel input differential pair in parallel with a P-channel differential pair, as shown in Figure 2. The N-channel pair is active for input voltages close to the positive rail, typically $(V_+) - 2.0$ V to 300mV above the positive supply, while the P-channel pair is on for inputs from 300mV below the negative supply to approximately $(V_+) - 1.5$ V. There is a small transition region, typically $(V_+) - 2.0$ V to $(V_+) - 1.5$ V, in which both pairs are on. This 500mV transition region can vary ± 100 mV with process variation. Thus, the transition region (both stages on) can range from $(V_+) - 2.1$ V to $(V_+) - 1.4$ V on the low end, up to $(V_+) - 1.9$ V to $(V_+) - 1.6$ V on the high end. Within the 500mV transition region PSRR, CMRR, offset voltage, and offset drift, and THD may vary compared to operation outside this region.

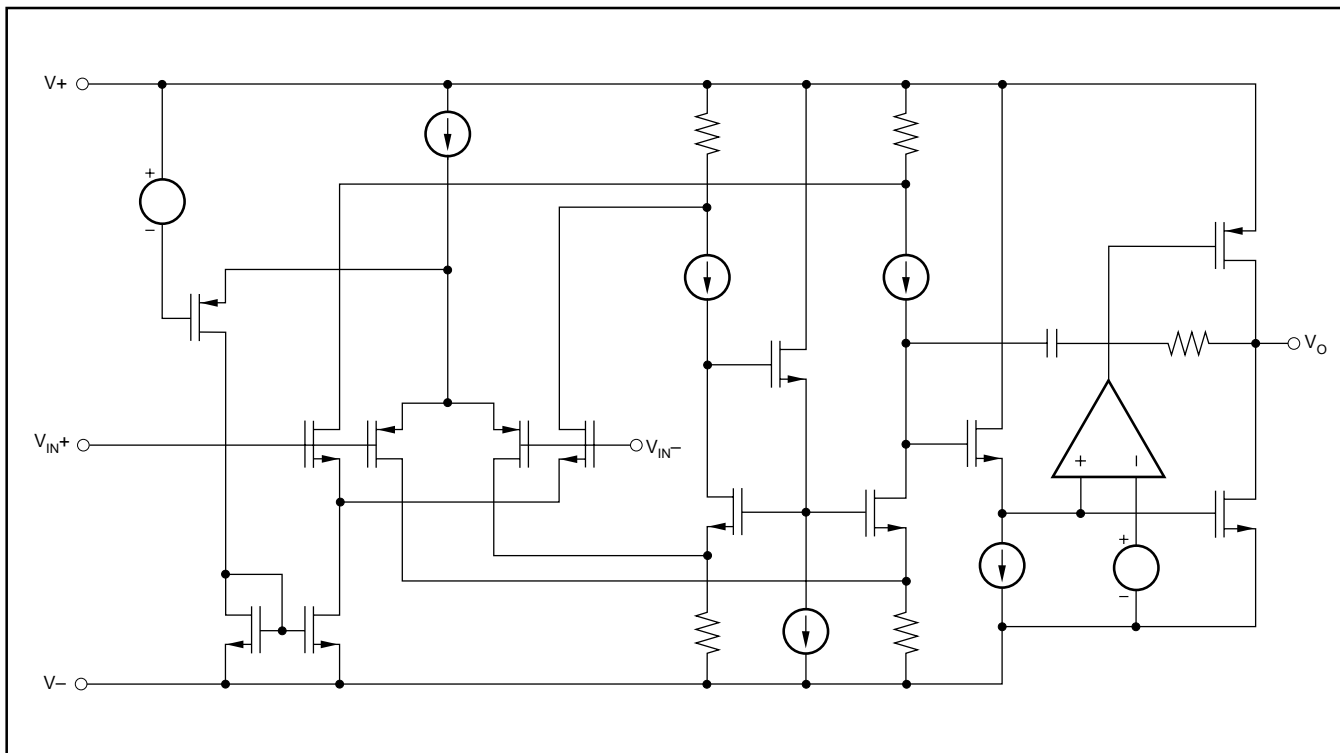

FIGURE 2. Simplified Schematic.

INPUT VOLTAGE

Device inputs are protected by ESD diodes that will conduct if the input voltages exceed the power supplies by more than approximately 300mV. Momentary voltages greater than 300mV beyond the power supply can be tolerated if the current is limited to 10mA. This is easily accomplished with an input resistor, as shown in Figure 3. Many input signals are inherently current-limited to less than 10mA; therefore, a limiting resistor is not always required. The OPA703 features no phase inversion when the inputs extend beyond supplies if the input current is limited, as seen in Figure 4.



FIGURE 3. Input Current Protection for Voltages Exceeding the Supply Voltage.



FIGURE 4. OPA703—No Phase Inversion with Inputs Greater than the Power-Supply Voltage.

RAIL-TO-RAIL OUTPUT

A class AB output stage with common-source transistors is used to achieve rail-to-rail output. This output stage is capable of driving 1k Ω loads connected to any point between V+ and ground. For light resistive loads (> 100k Ω), the output voltage can swing to 40mV from the supply rail. With moderate resistive loads (20k Ω), the output can swing to within 75mV from the supply rails while maintaining high open-loop gain (see the typical performance curve “Output Voltage Swing vs Output Current”).

CAPACITIVE LOAD AND STABILITY

The OPA703 and OPA704 series op amps can drive up to 1000pF pure capacitive load. Increasing the gain enhances the amplifier’s ability to drive greater capacitive loads (see the typical performance curve “Small Signal Overshoot vs Capacitive Load”).

One method of improving capacitive load drive in the unity-gain configuration is to insert a 10 Ω to 20 Ω resistor inside the feedback loop, as shown in Figure 5. This reduces ringing with large capacitive loads while maintaining DC accuracy.

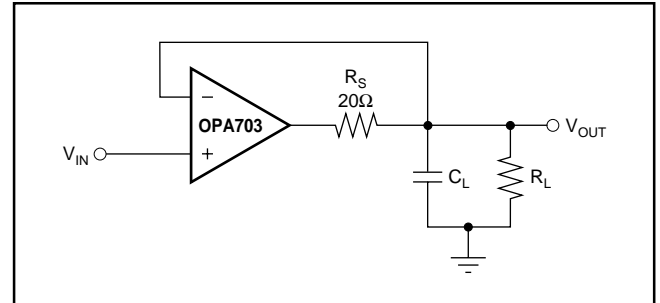

FIGURE 5. Series Resistor in Unity-Gain Buffer Configuration Improves Capacitive Load Drive.

APPLICATION CIRCUITS

Figure 6 shows a G = 5 non-inverting amplifier implemented with the OPA703 and OPA704 op amps. It demonstrates the increased speed characteristics (bandwidth, slew rate and settling time) that can be achieved with the OPA704 family when used in gains of five or greater. Some optimization of feedback capacitor value may be required to achieve best dynamic response. Circuits with closed-loop gains of less than five should use the OPA703 family for good stability and capacitive load drive. The OPA703 can be used in gains greater than five, but will not provide the increased speed benefits of the OPA704 family.

The OPA703 series op amps are optimized for driving medium-speed sampling data converters. The OPA703 op amps buffer the converter’s input capacitance and resulting charge injection while providing signal gain.

Figure 7 shows the OPA2703 in a dual-supply buffered reference configuration for the DAC7644. The DAC7644 is a 16-bit, low-power, quad-voltage output converter. Small size makes the combination ideal for automatic test equipment, data acquisition systems, and other low-power space-limited applications.

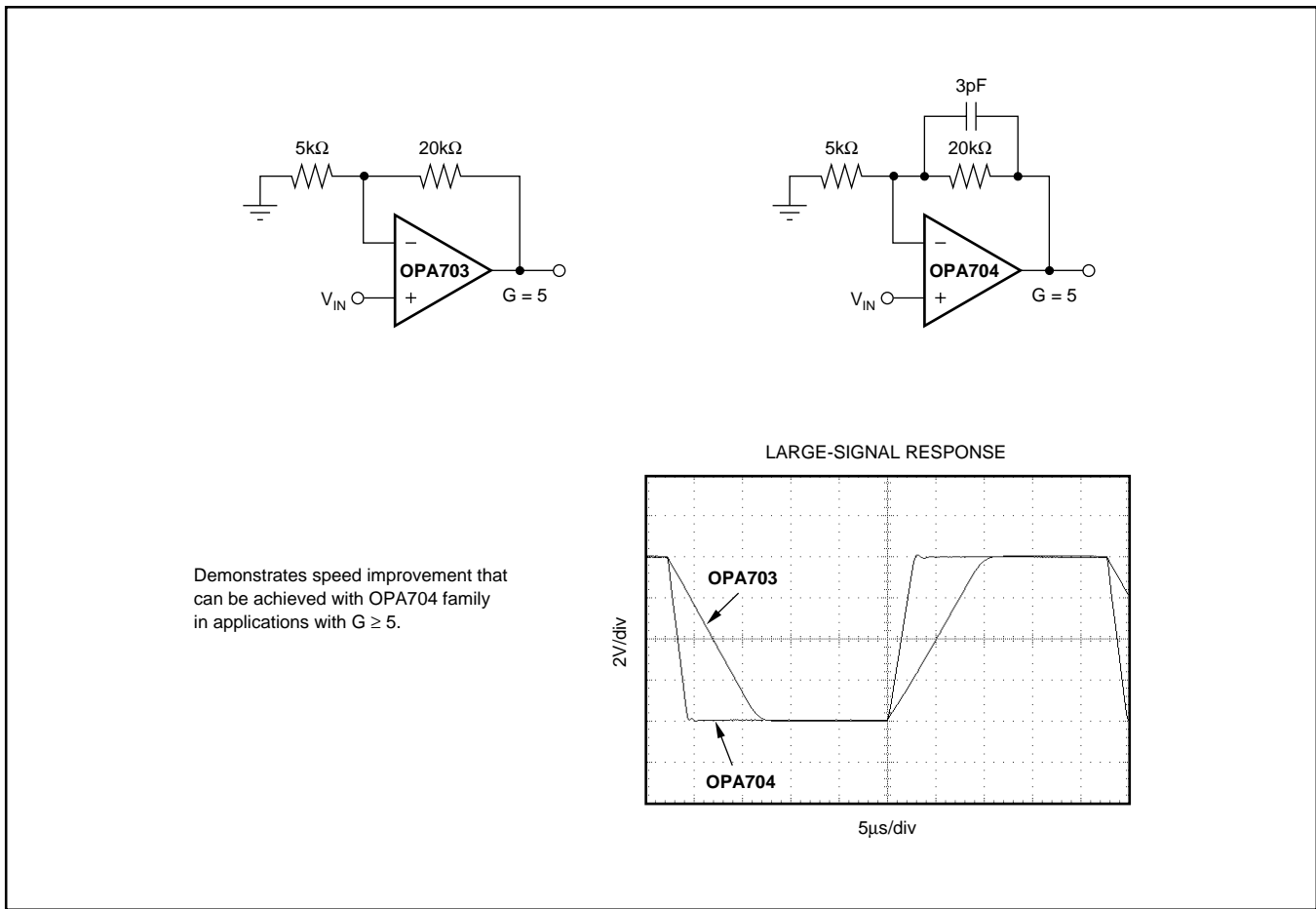

FIGURE 6. OPA704 Provides higher Speed in $G \geq 5$.



FIGURE 7. OPA703 as Dual Supply Configuration-Buffered References for the DAC7644.

PACKAGING INFORMATION

ORDERABLE DEVICE	STATUS(1)	PACKAGE TYPE	PACKAGE DRAWING	PINS	PACKAGE QTY
OPA2703EA/250	ACTIVE	VSSOP	DGK	8	250
OPA2703EA/2K5	ACTIVE	VSSOP	DGK	8	2500
OPA2703PA	ACTIVE	PDIP	P	8	50
OPA2703UA	ACTIVE	SOIC	D	8	100
OPA2703UA/2K5	ACTIVE	SOIC	D	8	2500
OPA2704EA/250	ACTIVE	VSSOP	DGK	8	250
OPA2704EA/2K5	ACTIVE	VSSOP	DGK	8	2500
OPA2704PA	ACTIVE	PDIP	P	8	50
OPA2704UA	ACTIVE	SOIC	D	8	100
OPA2704UA/2K5	ACTIVE	SOIC	D	8	2500
OPA4703EA/250	ACTIVE	TSSOP	PW	14	250
OPA4703EA/2K5	ACTIVE	TSSOP	PW	14	2500
OPA4703UA	ACTIVE	SOIC	D	14	58
OPA4703UA/2K5	ACTIVE	SOIC	D	14	2500
OPA4704EA/250	ACTIVE	TSSOP	PW	14	250
OPA4704EA/2K5	ACTIVE	TSSOP	PW	14	2500
OPA4704UA	ACTIVE	SOIC	D	14	58
OPA4704UA/2K5	ACTIVE	SOIC	D	14	2500
OPA703NA/250	ACTIVE	SOP	DBV	5	250
OPA703NA/3K	ACTIVE	SOP	DBV	5	3000
OPA703PA	ACTIVE	PDIP	P	8	50
OPA703UA	ACTIVE	SOIC	D	8	100
OPA703UA/2K5	ACTIVE	SOIC	D	8	2500
OPA704NA/250	ACTIVE	SOP	DBV	5	250
OPA704NA/3K	ACTIVE	SOP	DBV	5	3000
OPA704PA	ACTIVE	PDIP	P	8	50
OPA704UA	ACTIVE	SOIC	D	8	100
OPA704UA/2K5	ACTIVE	SOIC	D	8	2500

(1) The marketing status values are defined as follows:

ACTIVE: Product device recommended for new designs.

LIFEBUY: TI has announced that the device will be discontinued, and a lifetime-buy period is in effect.

NRND: Not recommended for new designs. Device is in production to support existing customers, but TI does not recommend using this part in a new design.

PREVIEW: Device has been announced but is not in production. Samples may or may not be available.

OBSOLETE: TI has discontinued the production of the device.

IMPORTANT NOTICE

Texas Instruments Incorporated and its subsidiaries (TI) reserve the right to make corrections, modifications, enhancements, improvements, and other changes to its products and services at any time and to discontinue any product or service without notice. Customers should obtain the latest relevant information before placing orders and should verify that such information is current and complete. All products are sold subject to TI's terms and conditions of sale supplied at the time of order acknowledgment.

TI warrants performance of its hardware products to the specifications applicable at the time of sale in accordance with TI's standard warranty. Testing and other quality control techniques are used to the extent TI deems necessary to support this warranty. Except where mandated by government requirements, testing of all parameters of each product is not necessarily performed.

TI assumes no liability for applications assistance or customer product design. Customers are responsible for their products and applications using TI components. To minimize the risks associated with customer products and applications, customers should provide adequate design and operating safeguards.

TI does not warrant or represent that any license, either express or implied, is granted under any TI patent right, copyright, mask work right, or other TI intellectual property right relating to any combination, machine, or process in which TI products or services are used. Information published by TI regarding third-party products or services does not constitute a license from TI to use such products or services or a warranty or endorsement thereof. Use of such information may require a license from a third party under the patents or other intellectual property of the third party, or a license from TI under the patents or other intellectual property of TI.

Reproduction of information in TI data books or data sheets is permissible only if reproduction is without alteration and is accompanied by all associated warranties, conditions, limitations, and notices. Reproduction of this information with alteration is an unfair and deceptive business practice. TI is not responsible or liable for such altered documentation.

Resale of TI products or services with statements different from or beyond the parameters stated by TI for that product or service voids all express and any implied warranties for the associated TI product or service and is an unfair and deceptive business practice. TI is not responsible or liable for any such statements.

Following are URLs where you can obtain information on other Texas Instruments products and application solutions:

Products		Applications	
Amplifiers	amplifier.ti.com	Audio	www.ti.com/audio
Data Converters	dataconverter.ti.com	Automotive	www.ti.com/automotive
DSP	dsp.ti.com	Broadband	www.ti.com/broadband
Interface	interface.ti.com	Digital Control	www.ti.com/digitalcontrol
Logic	logic.ti.com	Military	www.ti.com/military
Power Mgmt	power.ti.com	Optical Networking	www.ti.com/opticalnetwork
Microcontrollers	microcontroller.ti.com	Security	www.ti.com/security
		Telephony	www.ti.com/telephony
		Video & Imaging	www.ti.com/video
		Wireless	www.ti.com/wireless

Mailing Address: Texas Instruments
Post Office Box 655303 Dallas, Texas 75265

Copyright © 2003, Texas Instruments Incorporated

Copyright © Each Manufacturing Company.

All Datasheets cannot be modified without permission.

This datasheet has been download from :

www.AllDataSheet.com

100% Free DataSheet Search Site.

Free Download.

No Register.

Fast Search System.

www.AllDataSheet.com