

UCC2808A-1Q1, UCC2808A-2Q1 LOW POWER CURRENT MODE PUSH-PULL PWM

SGLS183 – AUGUST 2003

- Qualification in Accordance With AEC-Q100†
- Qualified for Automotive Applications
- Customer-Specific Configuration Control Can Be Supported Along With Major-Change Approval
- ESD Protection Exceeds 1500 V Per MIL-STD-883, Method 3015; Exceeds 200 V Using Machine Model (C = 200 pF, R = 0)
- Dual Output Drive Stages in Push-Pull Configuration
- Current Sense Discharge Transistor to Improve Dynamic Response
- 130- μ A Typical Starting Current
- 1-mA Typical Run Current
- Operation to 1 MHz
- Internal Soft Start
- On-Chip Error Amplifier With 2-MHz Gain Bandwidth Product
- On Chip VDD Clamping
- Output Drive Stages Capable of 500-mA Peak-Source Current, 1-A Peak-Sink Current

† Contact factory for details. Q100 qualification data available on request.

description

The UCC2808A is a family of BiCMOS push-pull, high-speed, low-power, pulse-width modulators. The UCC2808A contains all of the control and drive circuitry required for off-line or dc-to-dc fixed frequency current-mode switching power supplies with minimal external parts count.

The UCC2808A dual output drive stages are arranged in a push-pull configuration. Both outputs switch at half the oscillator frequency using a toggle flip-flop. The dead time between the two outputs is typically 60 ns to 200 ns depending on the values of the timing capacitor and resistors, thus limiting each output stage duty cycle to less than 50%.

The UCC2808A family offers a variety of package options and choice of undervoltage lockout levels. The family has UVLO thresholds and hysteresis options for off-line and battery powered systems. Thresholds are shown in the ordering information table.

The UCC2808A is an enhanced version of the UCC2808 family. The significant difference is that the A versions feature an internal discharge transistor from the CS pin to ground, which is activated each clock cycle during the oscillator dead time. The feature discharges any filter capacitance on the CS pin during each cycle and helps minimize filter capacitor values and current sense delay.

D PACKAGE
(TOP VIEW)

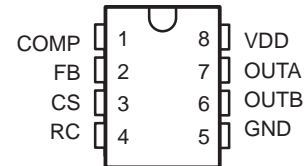

PW PACKAGE
(TOP VIEW)



Please be aware that an important notice concerning availability, standard warranty, and use in critical applications of Texas Instruments semiconductor products and disclaimers thereto appears at the end of this data sheet.

PRODUCTION DATA information is current as of publication date. Products conform to specifications per the terms of Texas Instruments standard warranty. Production processing does not necessarily include testing of all parameters.

 **TEXAS
INSTRUMENTS**

POST OFFICE BOX 655303 • DALLAS, TEXAS 75265

Copyright © 2003 Texas Instruments Incorporated

UCC2808A-1Q1, UCC2808A-2Q1

LOW POWER CURRENT MODE PUSH-PULL PWM

SGLS183 – AUGUST 2003

absolute maximum ratings over operating free-air temperature (unless otherwise noted)^{†‡}

Supply voltage ($I_{DD} \leq 10 \text{ mA}$)	15 V
Supply current	20 mA
OUTA/OUTB source current (peak)	-0.5 A
OUTA/OUTB sink current (peak)	1.0 A
Analog inputs (FB, CS)	-0.3 V to VDD 0.3 V, not to exceed 6 V
Power dissipation at $T_A = 25^\circ\text{C}$ (D package)	650 mW
Power dissipation at $T_A = 25^\circ\text{C}$ (PW package)	400 mW
Storage temperature, T_{stg}	-65°C to 150°C
Junction temperature, T_J	-55°C to 150°C
Lead temperature (soldering, 10 sec.)	300°C

[†] Stresses beyond those listed under “absolute maximum ratings” may cause permanent damage to the device. These are stress ratings only, and functional operation of the device at these or any other conditions beyond those indicated under “recommended operating conditions” is not implied. Exposure to absolute-maximum-rated conditions for extended periods may affect device reliability.

[‡] Currents are positive into, negative out of the specified terminal. Consult Packaging Section of the *Power Supply Control Data Book (TI Literature Number SLUD003)* for thermal limitations and considerations of packages.

electrical characteristics, $T_A = -40^\circ\text{C}$ to 125°C for the UCC2808AQ-x, VDD = 10 V (see Note 6), 1- μF capacitor from VDD to GND, R = 22 k Ω , C = 330 pF $T_A = T_J$, (unless otherwise noted)

PARAMETER	TEST CONDITIONS	MIN	TYP	MAX	UNITS
Oscillator Section					
Oscillator frequency		175	194	213	kHz
Oscillator amplitude/VDD	See Note 1	0.44	0.5	0.56	V/V

- NOTES: 1. Measured at RC. Signal amplitude tracks VDD.
 6. For UCCx808A-1, set VDD above the start threshold before setting at 10 V.



UCC2808A-1Q1, UCC2808A-2Q1

LOW POWER CURRENT MODE PUSH-PULL PWM

SGLS183 – AUGUST 2003

electrical characteristics, $T_A = -40^\circ\text{C}$ to 125°C for the UCC2808AQ-x, $V_{DD} = 10\text{ V}$ (see Note 6), $1\text{-}\mu\text{F}$ capacitor from V_{DD} to GND , $R = 22\text{ k}\Omega$, $C = 330\text{ pF}$ $T_A = T_J$, (unless otherwise noted)

PARAMETER	TEST CONDITIONS	MIN	TYP	MAX	UNITS
Error Amplifier Section					
Input voltage	COMP = 2 V	1.95	2	2.05	V
Input bias current		-1		1	μA
Open loop voltage gain		60	80		dB
COMP sink current	FB = 2.2 V, COMP = 1 V	0.3	2.5		mA
COMP source current	FB = 1.3 V, COMP = 3.5 V	-0.2	-0.5		mA
PWM Section					
Maximum duty cycle	Measured at OUTA or OUTB	48	49	50	%
Minimum duty cycle	COMP = 0 V			0	%
Current Sense Section					
Gain	See Note 2	1.9	2.2	2.5	V/V
Maximum input signal	COMP = 5 V See Note 3	0.45	0.5	0.55	V
CS to output delay	COMP = 3.5 V, CS from 0 mV to 600 mV		100	200	ns
CS source current		-200			nA
CS sink current	CS = 0.5 V, RC = 5.5 V See Note 7	4	10		mA
Over current threshold		0.65	0.75	0.85	V
COMP to CS offset	CS = 0 V	0.35	0.8	1.2	V
Output Section					
OUT low level	I = 100 mA		0.5	1.1	V
OUT high level	I = -50 mA, VDD - OUT		0.5	1	V
Rise time	$C_L = 1\text{ nF}$		25	60	ns
Fall time	$C_L = 1\text{ nF}$		25	60	ns
Undervoltage Lockout Section					
Start threshold	UCCx808A-1 See Note 6	11.5	12.5	13.5	V
	UCCx808A-2	4.1	4.3	4.5	V
Minimum operating voltage after start	UCCx808A-1	7.6	8.3	9	V
	UCCx808A-2	3.9	4.1	4.3	V
Hysteresis	UCCx808A-1	3.5	4.2	5.1	V
	UCCx808A-2	0.1	0.2	0.3	V
Soft Start Section					
COMP rise time	FB = 1.8 V, Rise from 0.5 V to 4 V		3.5	20	ms
Overall Section					
Startup current	$V_{DD} < \text{start threshold}$		130	260	μA
Operating supply current	FB = 0 V, CS = 0 V See Note 5 and 6		1	2	mA
VDD zener shunt voltage	IDD = 10 mA See Note 4	13	14	15	V

NOTES: 2. Gain is defined by: $A = \frac{\Delta V_{COMP}}{\Delta V_{CS}}$, $0 \leq V_{CS} \leq 0.4\text{ V}$.

3. Parameter measured at trip point of latch with FB at 0 V.

4. Start threshold and zener shunt threshold track one another.

5. Does not include current in the external oscillator network.

6. For UCC2808A-1, set VDD above the start threshold before setting at 10 V.

7. The internal current sink on the CS pin is designed to discharge an external filter capacitor. It is not intended to be a dc sink path.



pin assignments

COMP: COMP is the output of the error amplifier and the input of the PWM comparator. The error amplifier in the UCC2808A is a true low-output impedance, 2-MHz operational amplifier. As such, the COMP pin can both source and sink current. However, the error amplifier is internally current limited, so that zero duty cycle can be externally forced by pulling COMP to GND.

The UCC2808A family features built-in full-cycle soft start. Soft start is implemented as a clamp on the maximum COMP voltage.

CS: The input to the PWM, peak current, and overcurrent comparators. The overcurrent comparator is only intended for fault sensing. Exceeding the overcurrent threshold will cause a soft start cycle. An internal MOSFET discharges the current sense filter capacitor to improve dynamic performance of the power converter.

FB: The inverting input to the error amplifier. For best stability, keep FB lead length as short as possible and FB stray capacitance as small as possible.

GND: Reference ground and power ground for all functions. Due to high currents, and high frequency operation of the UCC2808A, a low impedance circuit board ground plane is highly recommended.

OUTA and OUTB: Alternating high current output stages. Both stages are capable of driving the gate of a power MOSFET. Each stage is capable of 500-mA peak-source current, and 1-A peak-sink current.

The output stages switch at half the oscillator frequency, in a push-pull configuration. When the voltage on the RC pin is rising, one of the two outputs is high, but during fall time, both outputs are off. This *dead time* between the two outputs, along with a slower output rise time than fall time, insures that the two outputs can not be on at the same time. This dead time is typically 60 ns to 200 ns and depends upon the values of the timing capacitor and resistor.

The high-current-output drivers consist of MOSFET output devices, which switch from VDD to GND. Each output stage also provides a very low impedance to overshoot and undershoot. This means that in many cases, external-schottky-clamp diodes are not required.

RC: The oscillator programming pin. The UCC2808A's oscillator tracks VDD and GND internally, so that variations in power supply rails minimally affect frequency stability. Figure 1 shows the oscillator block diagram.

Only two components are required to program the oscillator: a resistor (tied to the VDD and RC), and a capacitor (tied to the RC and GND). The approximate oscillator frequency is determined by the simple formula:

$$f_{\text{OSCILLATOR}} = \frac{1.41}{RC}$$

where frequency is in Hz, resistance in Ohms, and capacitance in Farads. The recommended range of timing resistors is between 10 k Ω and 200 k Ω and range of timing capacitors is between 100 pF and 1000 pF. Timing resistors less than 10 k Ω should be avoided.

For best performance, keep the timing capacitor lead to GND as short as possible, the timing resistor lead from VDD as short as possible, and the leads between timing components and RC as short as possible. Separate ground and VDD traces to the external timing network are encouraged.

UCC2808A-1Q1, UCC2808A-2Q1 LOW POWER CURRENT MODE PUSH-PULL PWM

SGLS183 – AUGUST 2003

pin assignments (continued)

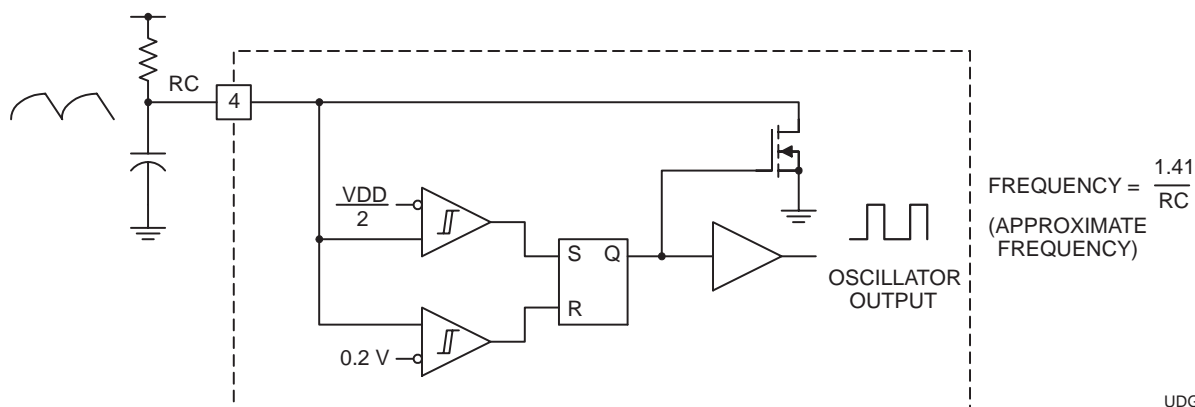

Figure 1. Block Diagram for Oscillator

NOTE A: The oscillator generates a sawtooth waveform on RC. During the RC rise time, the output stages alternate on time, but both stages are off during the RC fall time. The output stages switch a 1/2 the oscillator frequency, with ensured duty cycle of < 50% for both outputs.

VDD: The power input connection for this device. Although quiescent VDD current is very low, total supply current will be higher, depending on OUTA and OUTB current, and the programmed oscillator frequency. Total VDD current is the sum of quiescent VDD current and the average OUT current. Knowing the operating frequency and the MOSFET gate charge (Qg), average OUT current can be calculated from:

$$I_{OUT} = Q_g \times F, \text{ where } F \text{ is frequency}$$

To prevent noise problems, bypass VDD to GND with a ceramic capacitor as close to the chip as possible along with an electrolytic capacitor. A 1- μ F decoupling capacitor is recommended.

APPLICATION INFORMATION

A 200-kHz push-pull application circuit with a full-wave rectifier is shown in Figure 2. The output, V_O , provides 5 V at 50 W maximum and is electrically isolated from the input. Since the UCC2808A is a peak-current-mode controller the 2N2907 emitter following amplifier (buffers the CT waveform) provides slope compensation which is necessary for duty ratios greater than 50%. Capacitor decoupling is very important with a single ground IC controller, and a 1 μ F is suggested as close to the IC as possible. The controller supply is a series RC for start-up, paralleled with a bias winding on the output inductor used in steady state operation.

Isolation is provided by an optocoupler with regulation done on the secondary side using the TL431 adjustable precision shunt regulator. Small signal compensation with tight voltage regulation is achieved using this part on the secondary side. Many choices exist for the output inductor depending on cost, volume, and mechanical strength. Several design options are iron powder, molypermalloy (MPP), or a ferrite core with an air gap as shown here. The main power transformer has a Magnetics Inc. ER28 size core made of P material for efficient operation at this frequency and temperature. The input voltage may range from 36 V dc to 72 V dc.

UCC2808A-1Q1, UCC2808A-2Q1 LOW POWER CURRENT MODE PUSH-PULL PWM

SGLS183 – AUGUST 2003

TYPICAL CHARACTERISTICS

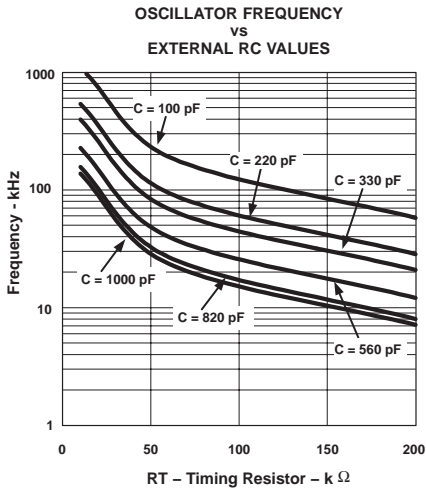

Figure 3

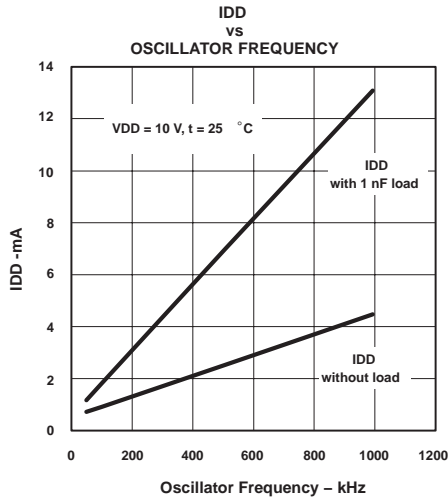

Figure 4

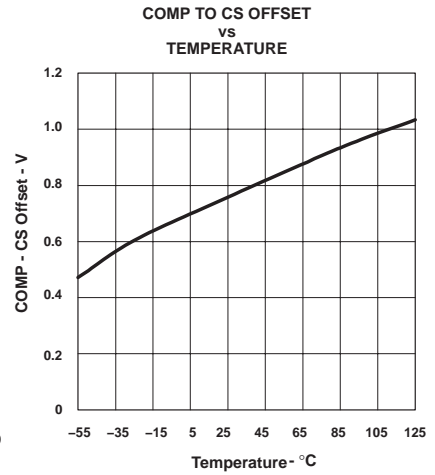

Figure 5

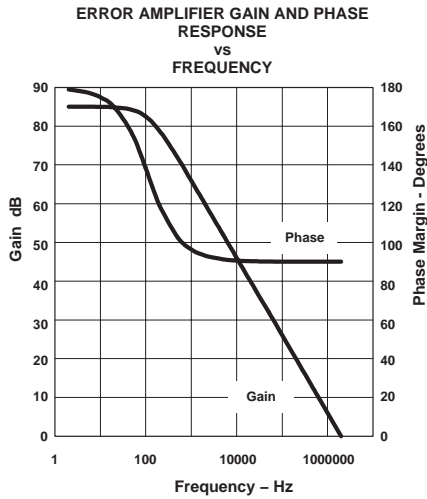

Figure 6

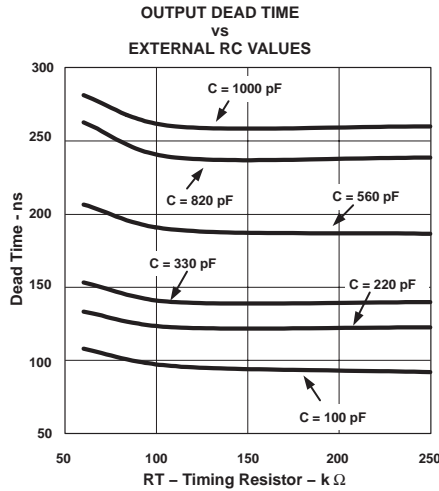

Figure 7

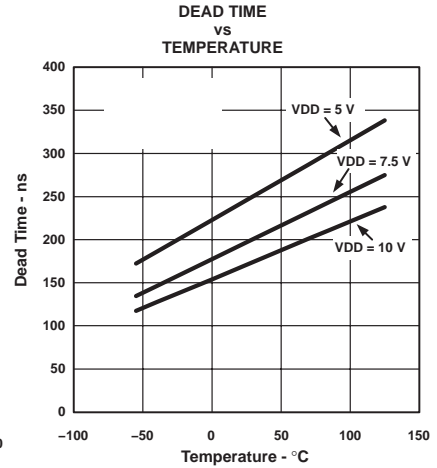

Figure 8

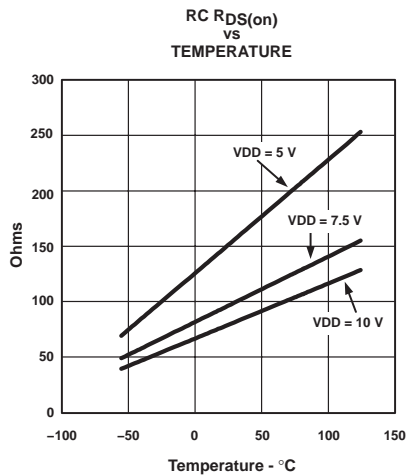

Figure 9

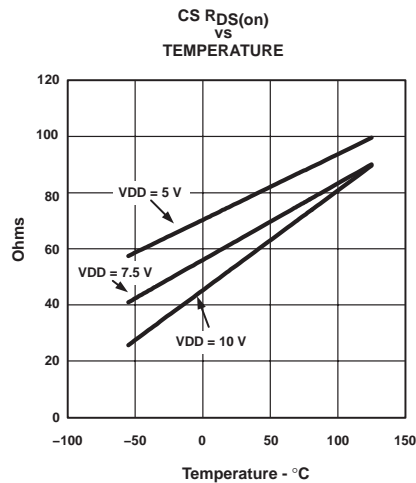

Figure 10



PACKAGING INFORMATION

Orderable Device	Status ⁽¹⁾	Package Type	Package Drawing	Pins	Package Qty	Eco Plan ⁽²⁾	Lead/Ball Finish	MSL Peak Temp ⁽³⁾
UCC2808AQDR-1Q1	ACTIVE	SOIC	D	8	2500	TBD	Call TI	Level-1-220C-UNLIM
UCC2808AQDR-2Q1	ACTIVE	SOIC	D	8	2500	TBD	Call TI	Level-1-220C-UNLIM

⁽¹⁾ The marketing status values are defined as follows:

ACTIVE: Product device recommended for new designs.

LIFEBUY: TI has announced that the device will be discontinued, and a lifetime-buy period is in effect.

NRND: Not recommended for new designs. Device is in production to support existing customers, but TI does not recommend using this part in a new design.

PREVIEW: Device has been announced but is not in production. Samples may or may not be available.

OBsolete: TI has discontinued the production of the device.

⁽²⁾ Eco Plan - The planned eco-friendly classification: Pb-Free (RoHS) or Green (RoHS & no Sb/Br) - please check <http://www.ti.com/productcontent> for the latest availability information and additional product content details.

TBD: The Pb-Free/Green conversion plan has not been defined.

Pb-Free (RoHS): TI's terms "Lead-Free" or "Pb-Free" mean semiconductor products that are compatible with the current RoHS requirements for all 6 substances, including the requirement that lead not exceed 0.1% by weight in homogeneous materials. Where designed to be soldered at high temperatures, TI Pb-Free products are suitable for use in specified lead-free processes.

Green (RoHS & no Sb/Br): TI defines "Green" to mean Pb-Free (RoHS compatible), and free of Bromine (Br) and Antimony (Sb) based flame retardants (Br or Sb do not exceed 0.1% by weight in homogeneous material)

⁽³⁾ MSL, Peak Temp. -- The Moisture Sensitivity Level rating according to the JEDEC industry standard classifications, and peak solder temperature.

Important Information and Disclaimer:The information provided on this page represents TI's knowledge and belief as of the date that it is provided. TI bases its knowledge and belief on information provided by third parties, and makes no representation or warranty as to the accuracy of such information. Efforts are underway to better integrate information from third parties. TI has taken and continues to take reasonable steps to provide representative and accurate information but may not have conducted destructive testing or chemical analysis on incoming materials and chemicals. TI and TI suppliers consider certain information to be proprietary, and thus CAS numbers and other limited information may not be available for release.

In no event shall TI's liability arising out of such information exceed the total purchase price of the TI part(s) at issue in this document sold by TI to Customer on an annual basis.

IMPORTANT NOTICE

Texas Instruments Incorporated and its subsidiaries (TI) reserve the right to make corrections, modifications, enhancements, improvements, and other changes to its products and services at any time and to discontinue any product or service without notice. Customers should obtain the latest relevant information before placing orders and should verify that such information is current and complete. All products are sold subject to TI's terms and conditions of sale supplied at the time of order acknowledgment.

TI warrants performance of its hardware products to the specifications applicable at the time of sale in accordance with TI's standard warranty. Testing and other quality control techniques are used to the extent TI deems necessary to support this warranty. Except where mandated by government requirements, testing of all parameters of each product is not necessarily performed.

TI assumes no liability for applications assistance or customer product design. Customers are responsible for their products and applications using TI components. To minimize the risks associated with customer products and applications, customers should provide adequate design and operating safeguards.

TI does not warrant or represent that any license, either express or implied, is granted under any TI patent right, copyright, mask work right, or other TI intellectual property right relating to any combination, machine, or process in which TI products or services are used. Information published by TI regarding third-party products or services does not constitute a license from TI to use such products or services or a warranty or endorsement thereof. Use of such information may require a license from a third party under the patents or other intellectual property of the third party, or a license from TI under the patents or other intellectual property of TI.

Reproduction of information in TI data books or data sheets is permissible only if reproduction is without alteration and is accompanied by all associated warranties, conditions, limitations, and notices. Reproduction of this information with alteration is an unfair and deceptive business practice. TI is not responsible or liable for such altered documentation.

Resale of TI products or services with statements different from or beyond the parameters stated by TI for that product or service voids all express and any implied warranties for the associated TI product or service and is an unfair and deceptive business practice. TI is not responsible or liable for any such statements.

Following are URLs where you can obtain information on other Texas Instruments products and application solutions:

Products		Applications	
Amplifiers	amplifier.ti.com	Audio	www.ti.com/audio
Data Converters	dataconverter.ti.com	Automotive	www.ti.com/automotive
DSP	dsp.ti.com	Broadband	www.ti.com/broadband
Interface	interface.ti.com	Digital Control	www.ti.com/digitalcontrol
Logic	logic.ti.com	Military	www.ti.com/military
Power Mgmt	power.ti.com	Optical Networking	www.ti.com/opticalnetwork
Microcontrollers	microcontroller.ti.com	Security	www.ti.com/security
		Telephony	www.ti.com/telephony
		Video & Imaging	www.ti.com/video
		Wireless	www.ti.com/wireless

Mailing Address: Texas Instruments
Post Office Box 655303 Dallas, Texas 75265

Copyright © Each Manufacturing Company.

All Datasheets cannot be modified without permission.

This datasheet has been download from :

www.AllDataSheet.com

100% Free DataSheet Search Site.

Free Download.

No Register.

Fast Search System.

www.AllDataSheet.com