

#### OUTLINE DRAWING

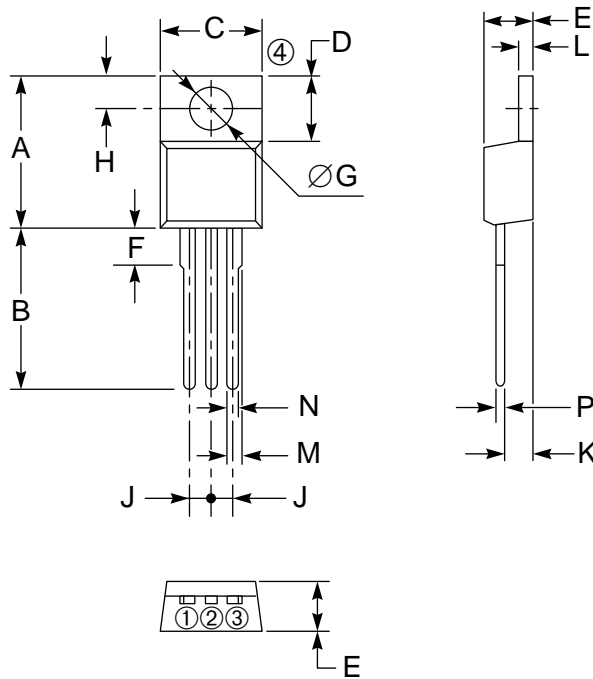

#### CONNECTION DIAGRAM

- ① T1 TERMINAL
- ② T2 TERMINAL
- ③ GATE
- ④ T2 TERMINAL

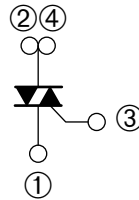

Outline Drawing (Conforms to TO-220)

Dimensions	Inches	Millimeters
A	0.63 Max.	16.0 Max.
B	0.49 Max.	12.5 Max.
C	0.41 Max.	10.5 Max.
D	0.28	7.0
E	0.18	4.5
F	0.15 Max.	3.8 Max.
G	0.142 ± 0.008 Dia.	3.6 ± 0.2 Dia.

Dimensions	Inches	Millimeters
H	0.125 ± 0.008	3.2 ± 0.2
J	0.99	2.54
K	0.10	2.6
L	0.051	1.3
M	0.051	1.3
N	0.031	0.8
P	0.020	0.5

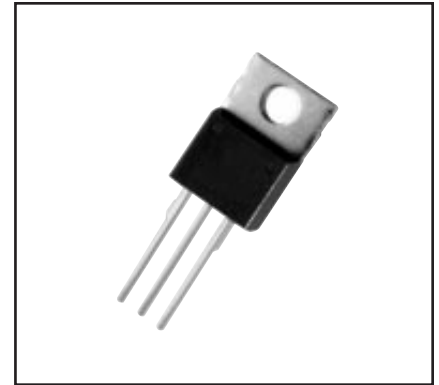

#### Description:

A triac is a solid state silicon AC switch which may be gate triggered from an off-state to an on-state for either polarity of applied voltage.

#### Features:

- Planar Passivation
- Selected for Inductive Loads

#### Applications:

- AC Switch
- Heating
- Motor Controls
- Switch Mode Power Supply
- Lighting
- Solid State Relay

#### Ordering Information:

Example: Select the complete eight, nine or ten digit part number you desire from the table - i.e. BCR20AM-8 is a 400 Volt, 20 Ampere Triac

Type	V <sub>DRM</sub> Volts	Code	Inductive Load*
BCR20AM	400	-8	L
	600	-12	

\*For inductive load, add L.

## BCR20AM

### Triac

20 Ampere/400-600 Volts

### Absolute Maximum Ratings, $T_a = 25^\circ\text{C}$ unless otherwise specified

Ratings	Symbol	BCR20AM-8	BCR20AM-12	Units
On-state Current, $T_c = 105^\circ\text{C}$	$I_{T(RMS)}$	20	20	Amperes
Repetitive Peak Off-state Voltage (Gate Open)	$V_{DRM}$	400	600	Volts
Non-repetitive Peak Off-state Voltage (Gate Open)	$V_{DSM}$	500	720	Volts
Non-repetitive Peak On-state Voltage, One Cycle (60 Hz)	$I_{TSM}$	200	200	Amperes
$I^2t$ for Fusing, $t = 8.3$ msec	$I^2t$	167	167	$\text{A}^2\text{sec}$
Peak Gate Power Dissipation, 20 $\mu\text{sec}$	$P_{GM}$	5	5	Watts
Average Gate Power Dissipation	$P_{G(avg)}$	0.5	0.5	Watts
Peak Gate Current	$I_{GM}$	2	2	Amperes
Peak Gate Voltage	$V_{GM}$	10	10	Volts
Storage Temperature	$T_{stg}$	-40 to 125	-40 to 125	$^\circ\text{C}$
Operating Temperature	$T_j$	-40 to 125	-40 to 125	$^\circ\text{C}$
Weight	—	2.0	2.0	Grams

### Electrical and Thermal Characteristics, $T_j = 25^\circ\text{C}$ unless otherwise specified

Characteristics	Symbol	Test Conditions (Trigger Mode)				BCR30GM			Units
		$V_D$	$R_L$	$R_G$	$T_j$	Min.	Typ.	Max.	
Gate Parameters									
DC Gate Trigger Current									
MT2+ Gate+	$I_{FGT I}$	6V	6 $\Omega$	330 $\Omega$	25 $^\circ\text{C}$	—	—	30	mA
MT2+ Gate-	$I_{RGT I}$	6V	6 $\Omega$	330 $\Omega$	25 $^\circ\text{C}$	—	—	30	mA
MT2- Gate-	$I_{RGT III}$	6V	6 $\Omega$	330 $\Omega$	25 $^\circ\text{C}$	—	—	30	mA
DC Gate Trigger Voltage									
MT2+ Gate+	$V_{FGT I}$	6V	6 $\Omega$	330 $\Omega$	25 $^\circ\text{C}$	—	—	1.5	Volts
MT2+ Gate-	$V_{RGT I}$	6V	6 $\Omega$	330 $\Omega$	25 $^\circ\text{C}$	—	—	1.5	Volts
MT2- Gate-	$V_{RGT III}$	6V	6 $\Omega$	330 $\Omega$	25 $^\circ\text{C}$	—	—	1.5	Volts
DC Gate Non-trigger Voltage									
All	$V_{GD}$	1/2 $V_{DRM}$	—	—	125 $^\circ\text{C}$	0.2	—	—	Volts
Thermal Resistance, Junction-to-case	$R_{th(j-c)}$	—	—	—	—	—	—	0.8	$^\circ\text{C}/\text{W}$
Voltage – Blocking State Repetitive Off-state Current	$I_{DRM}$	Gate Open Circuited, $V_D = V_{DRM}$ , $T_j = 125^\circ\text{C}$				—	—	2	mA
Current – Conducting State Peak On-state Voltage	$V_{TM}$	$T_c = 25^\circ\text{C}$ , $I_{TM} = 30\text{A}$				—	—	1.5	Volts
Critical Rate-of-Rise of Commutating Off-state Voltage (Commutating $dv/dt$ ) ▲ (Switching)	$(dv/dt)_C$	—	—	—	—	—	—	—	$\text{V}/\mu\text{s}$

$\Delta$ Part Number	$V_{DRM}$ (Volts)	Commutating $dv/dt$ , $(dv/dt)_C$ ( $\text{V}/\mu\text{sec}$ ) Minimum	Test Condition	Commutating Voltage & Current Waveform (Inductive Load)
BCR20AM-8	400	—	$T_j = 125^\circ\text{C}$ , Rate of Decay	
BCR20AM-8L	—	10	On-state Commutating Current	
BCR20AM-12	600	—	$(dv/dt)_C = -10\text{A}/\text{msec}$ ,	
BCR20AM-12L	—	10	Peak Off-state Voltage $V_D = 400\text{V}$	

## BCR20AM

### Triac

20 Ampere/400-600 Volts

**MAXIMUM ON-STATE CHARACTERISTICS**

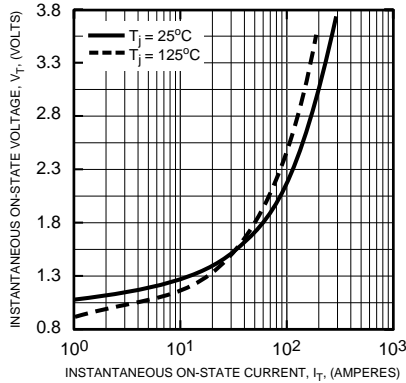

**TRANSIENT THERMAL IMPEDANCE CHARACTERISTICS (JUNCTION-TO-CASE)**

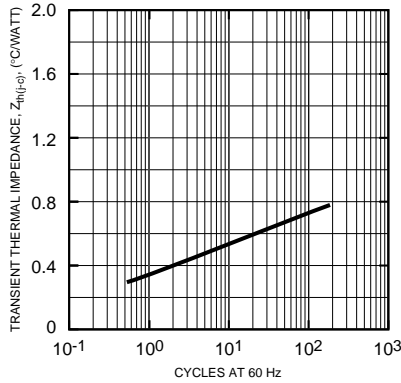

**GATE CHARACTERISTICS (I, II, III)**

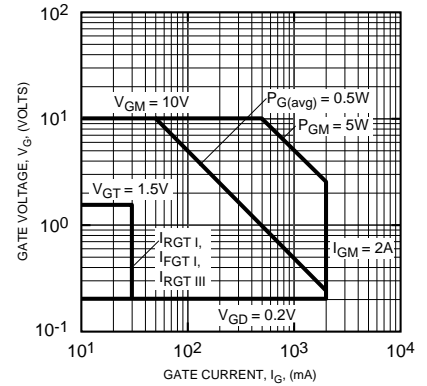

**MAXIMUM SURGE CURRENT FOLLOWING RATED LOAD CONDITIONS**

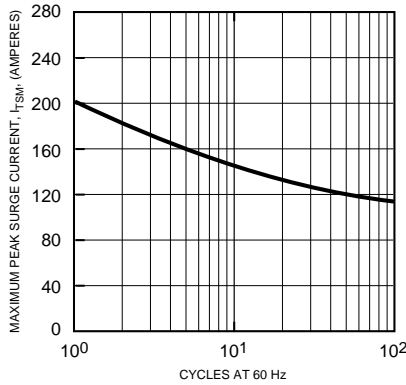

**ALLOWABLE CASE TEMPERATURE VS. RMS ON-STATE CURRENT**

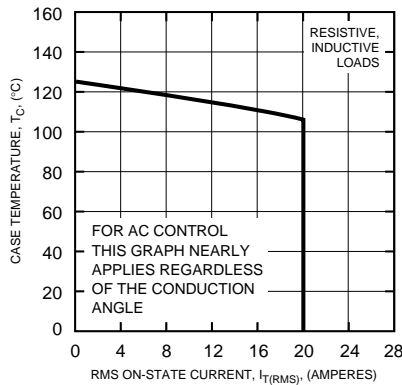

**ALLOWABLE AMBIENT TEMPERATURE VS. RMS ON-STATE CURRENT**

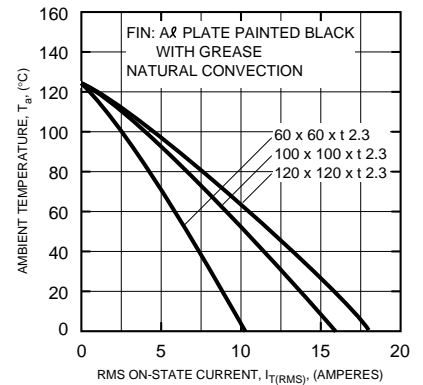

**ALLOWABLE AMBIENT TEMPERATURE VS. RMS ON-STATE CURRENT**

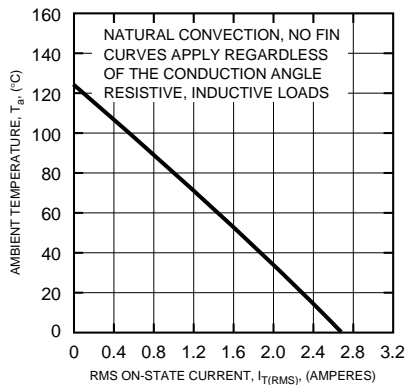

**MAXIMUM ON-STATE POWER DISSIPATION**

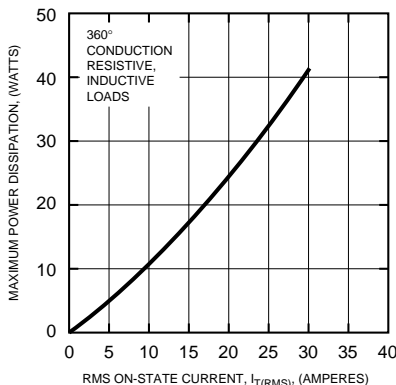

**GATE TRIGGER CURRENT VS. JUNCTION TEMPERATURE (TYPICAL)**

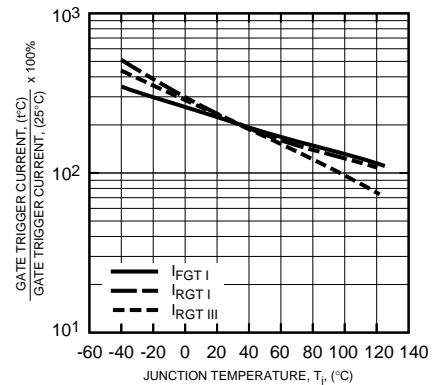

## BCR20AM

### Triac

20 Ampere/400-600 Volts

**GATE TRIGGER VOLTAGE VS. JUNCTION TEMPERATURE (TYPICAL)**

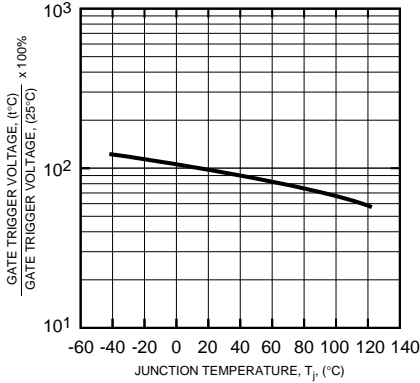

**HOLDING CURRENT VS. JUNCTION TEMPERATURE (TYPICAL)**

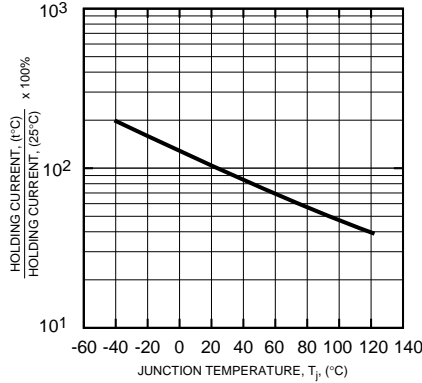

**LATCHING CURRENT VS. JUNCTION TEMPERATURE (TYPICAL)**

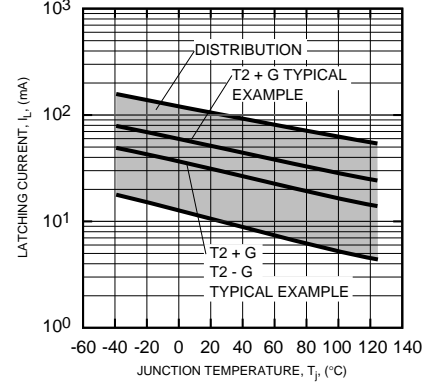

**BREAKOVER VOLTAGE VS. JUNCTION TEMPERATURE (TYPICAL)**

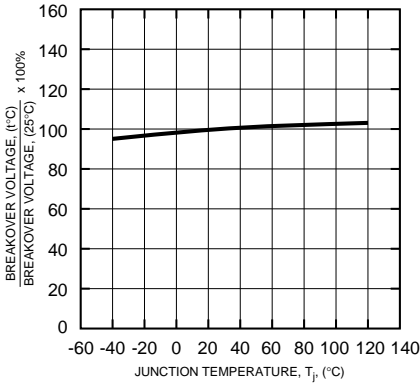

**BREAKOVER VOLTAGE VS. RATE OF RISE OF OFF-STATE VOLTAGE (TYPICAL)**

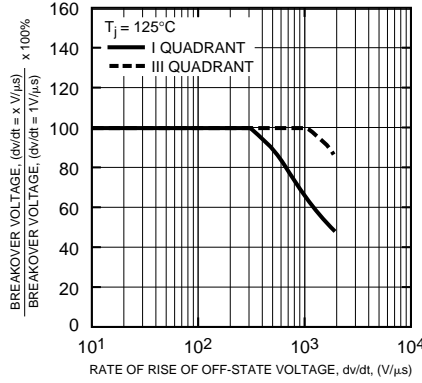

**REPETITIVE PEAK OFF-STATE CURRENT VS. JUNCTION TEMPERATURE (TYPICAL)**

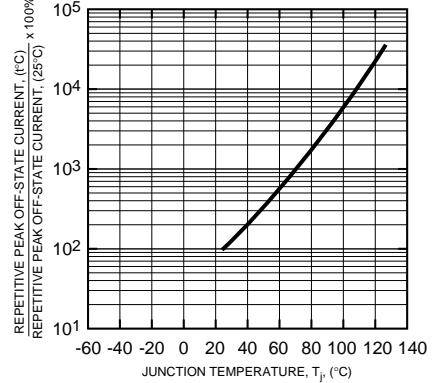

**COMMUTATION CHARACTERISTICS (TYPICAL)**

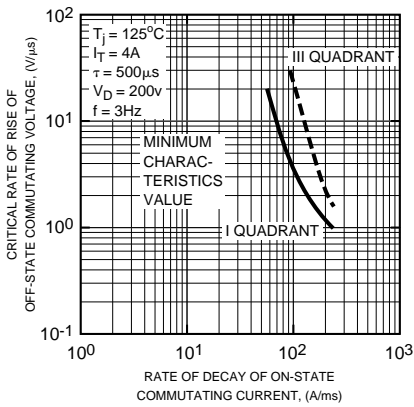

**GATE TRIGGER CURRENT VS. GATE CURRENT PULSE WIDTH (TYPICAL)**

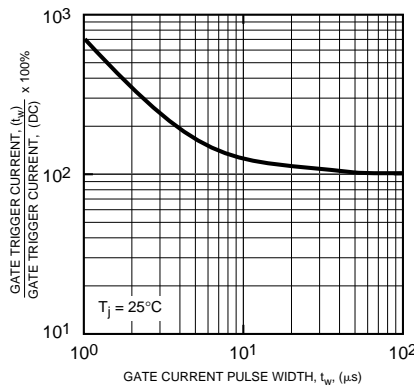

**GATE TRIGGER CHARACTERISTICS TEST CIRCUITS**

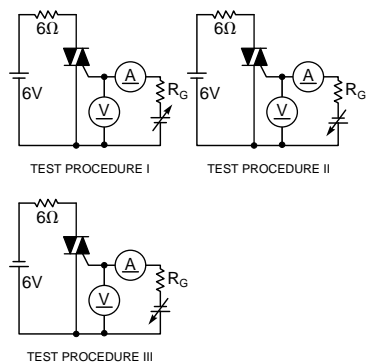

Copyright © Each Manufacturing Company.

All Datasheets cannot be modified without permission.

This datasheet has been download from :

[www.AllDataSheet.com](http://www.AllDataSheet.com)

100% Free DataSheet Search Site.

Free Download.

No Register.

Fast Search System.

[www.AllDataSheet.com](http://www.AllDataSheet.com)