

Triac 30 Ampere/400-600 Volts

OUTLINE DRAWING

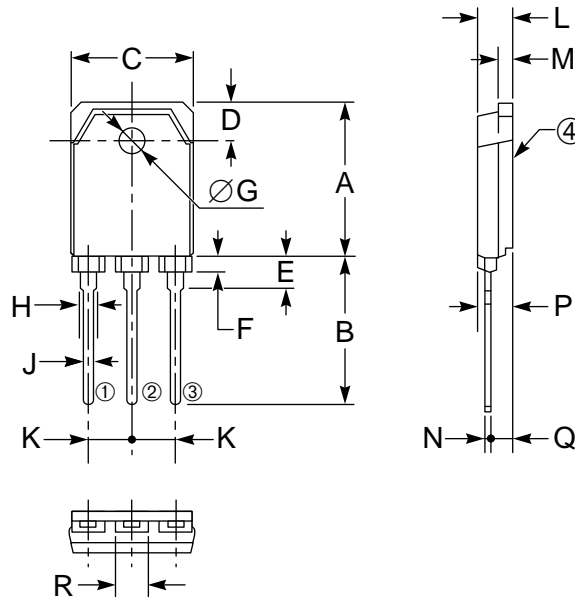

CONNECTION DIAGRAM

- ① T1 TERMINAL
- ② T2 TERMINAL
- ③ GATE
- ④ T2 TERMINAL

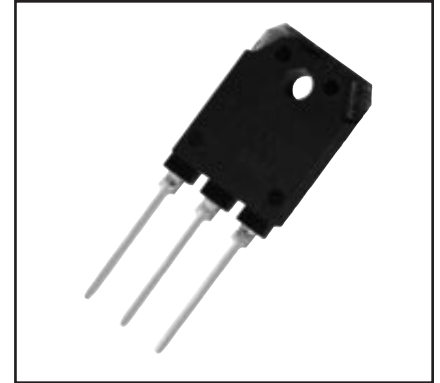
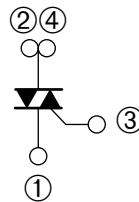

Description:

A triac is a solid state silicon AC switch which may be gate triggered from an off-state to an on-state for either polarity of applied voltage.

Features:

- Planar Passivation
- Selected for Inductive Loads

Applications:

- Contactless AC Switches
- Microwave Ovens
- Motor Controls
- Lighting Controls

Ordering Information:

Example: Select the complete eight, nine or ten digit part number you desire from the table - i.e. BCR30AM-8 is a 400 Volt, 30 Ampere Triac.

Outline Drawing (Conforms to TO-3P)

Dimensions	Inches	Millimeters
A	0.79	20.0
B	0.77	19.5
C	0.63	15.9
D	0.20	5.0
E	0.16	4.0
F	0.08	2.0
G	0.13 Dia.	3.2 Dia.
H	0.08	2.0

Dimensions	Inches	Millimeters
J	0.04	1.0
K	0.21	5.45
L	0.18	4.5
M	0.06	1.5
N	0.02	0.6
P	0.17	4.4
Q	0.11	2.8
R	0.16	4.0

Type	V _{DRM} Volts	Code	Inductive Load*
BCR30AM	400	-8	L
	600	-12	

*For inductive load, add L.

BCR30AM

Triac

30 Ampere/400-600 Volts

Absolute Maximum Ratings, $T_a = 25\text{ }^\circ\text{C}$ unless otherwise specified

Ratings	Symbol	BCR30AM-8	BCR30AM-12	Units
On-state Current, $T_c = 75^\circ\text{C}$	$I_{T(RMS)}$	30	30	Amperes
Repetitive Peak Off-state Voltage (Gate Open)	V_{DRM}	400	600	Volts
Non-repetitive Peak Off-state Voltage (Gate Open)	V_{DSM}	500	720	Volts
Non-repetitive Peak On-state Voltage, One Cycle (60 Hz)	I_{TSM}	300	300	Amperes
I^2t for Fusing, $t = 8.3\text{ msec}$	I^2t	378	378	A^2sec
Peak Gate Power Dissipation, $20\text{ }\mu\text{sec}$	P_{GM}	5	5	Watts
Average Gate Power Dissipation	$P_{G(avg)}$	0.5	0.5	Watts
Peak Gate Current	I_{GM}	2	2	Amperes
Peak Gate Voltage	V_{GM}	10	10	Volts
Storage Temperature	T_{stg}	-40 to 125	-40 to 125	$^\circ\text{C}$
Operating Temperature	T_j	-40 to 125	-40 to 125	$^\circ\text{C}$
Weight	–	4.8	4.8	Grams

Electrical and Thermal Characteristics, $T_j = 25\text{ }^\circ\text{C}$ unless otherwise specified

Characteristics	Symbol	Test Conditions (Trigger Mode)				BCR30GM			Units
		V_D	R_L	R_G	T_j	Min.	Typ.	Max.	
Gate Parameters									
DC Gate Trigger Current									
MT2+ Gate+	$I_{FGT I}$	6V	6 Ω	330 Ω	25 $^\circ\text{C}$	–	–	50	mA
MT2+ Gate–	$I_{RGT I}$	6V	6 Ω	330 Ω	25 $^\circ\text{C}$	–	–	50	mA
MT2– Gate–	$I_{RGT III}$	6V	6 Ω	330 Ω	25 $^\circ\text{C}$	–	–	50	mA
DC Gate Trigger Voltage									
MT2+ Gate+	$V_{FGT I}$	6V	6 Ω	330 Ω	25 $^\circ\text{C}$	–	–	2.5	Volts
MT2+ Gate–	$V_{RGT I}$	6V	6 Ω	330 Ω	25 $^\circ\text{C}$	–	–	2.5	Volts
MT2– Gate–	$V_{RGT III}$	6V	6 Ω	330 Ω	25 $^\circ\text{C}$	–	–	2.5	Volts
DC Gate Non-trigger Voltage									
All	V_{GD}	1/2 V_{DRM}	–	–	125 $^\circ\text{C}$	0.2	–	–	Volts

Characteristics	Symbol	Test Conditions	Min.	Typ.	Max.	Units
Thermal Resistance, Junction-to-case	$R_{th(c-f)}$	–	–	–	1.2	$^\circ\text{C}/\text{W}$
Voltage – Blocking State Repetitive Off-state Current	I_{DRM}	Gate Open Circuited, $V_D = V_{DRM}$, $T_j = 125^\circ\text{C}$	–	–	3	mA
Current – Conducting State Peak On-state Voltage	V_{TM}	$T_c = 25^\circ\text{C}$, $I_{TM} = 45\text{A}$	–	–	1.6	Volts
Critical Rate-of-Rise of Commutating Off-state Voltage (Commutating dv/dt) ▲ (Switching)	$(dv/dt)_c$	–	–	–	–	$\text{V}/\mu\text{s}$



Powerex, Inc., 200 Hillis Street, Youngwood, Pennsylvania 15697-1800 (412) 925-7272

BCR30AM

Triac

30 Ampere/400-600 Volts

MAXIMUM ON-STATE CHARACTERISTICS

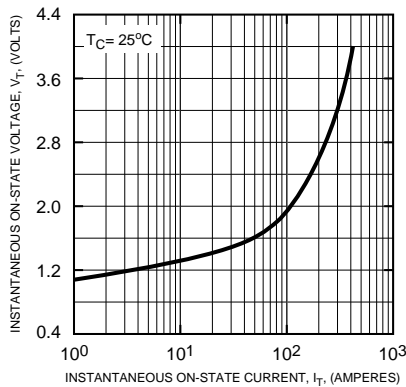

TRANSIENT THERMAL IMPEDANCE CHARACTERISTICS

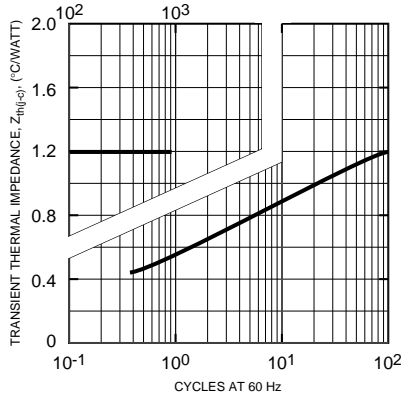

GATE CHARACTERISTICS (I, II, III)

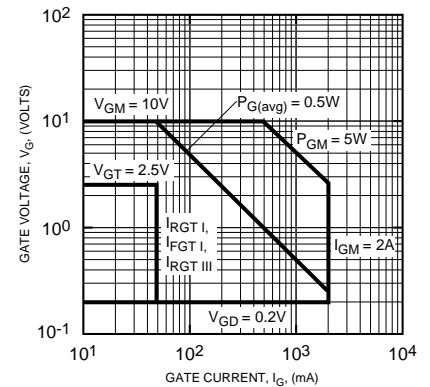

MAXIMUM SURGE CURRENT FOLLOWING RATED LOAD CONDITIONS

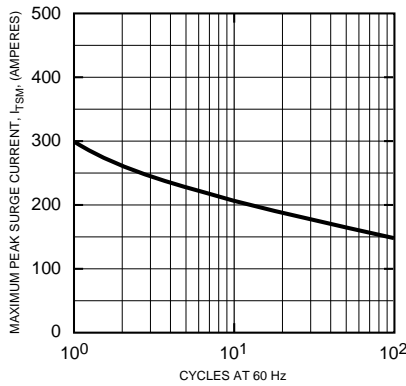

ALLOWABLE CASE TEMPERATURE VS. RMS ON-STATE CURRENT

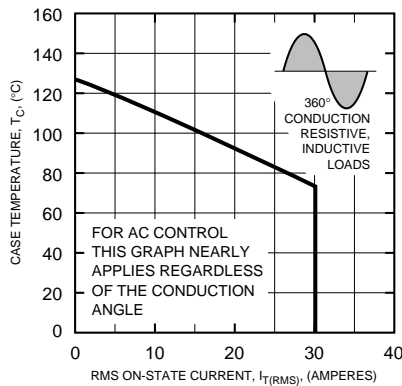

ALLOWABLE AMBIENT TEMPERATURE VS. RMS ON-STATE CURRENT

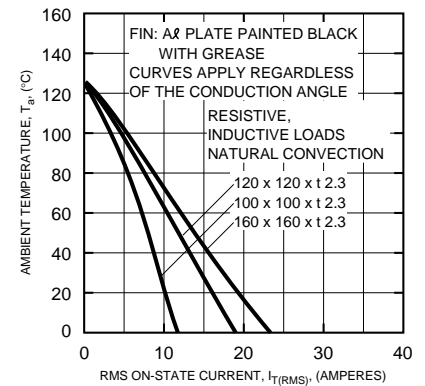

MAXIMUM ON-STATE POWER DISSIPATION

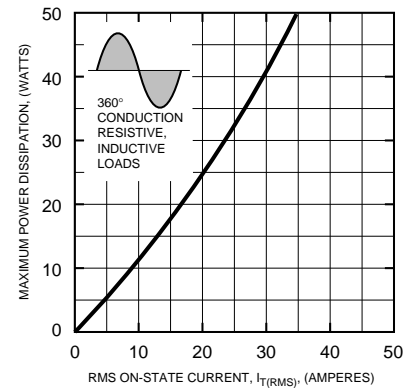

GATE TRIGGER CURRENT VS. JUNCTION TEMPERATURE (TYPICAL)

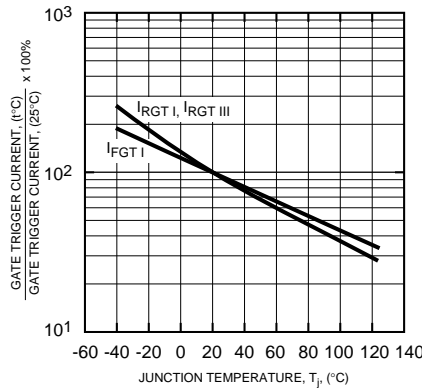

GATE TRIGGER VOLTAGE VS. JUNCTION TEMPERATURE (TYPICAL)

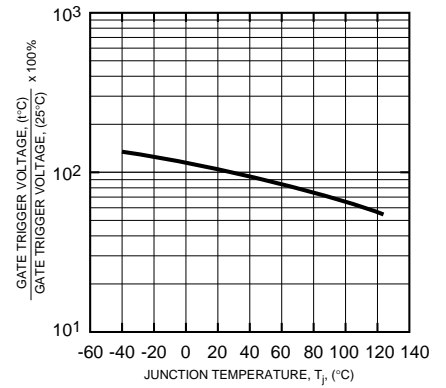

BCR30AM

Triac

30 Ampere/400-600 Volts

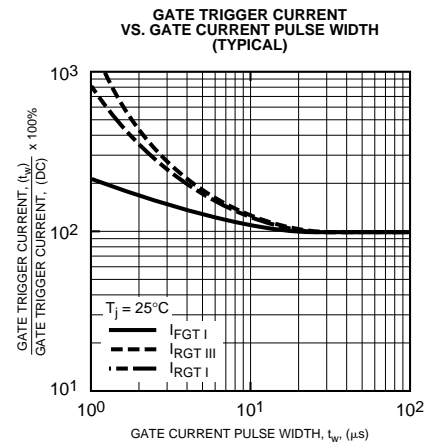
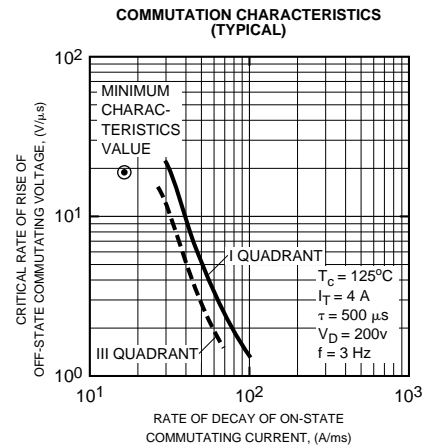
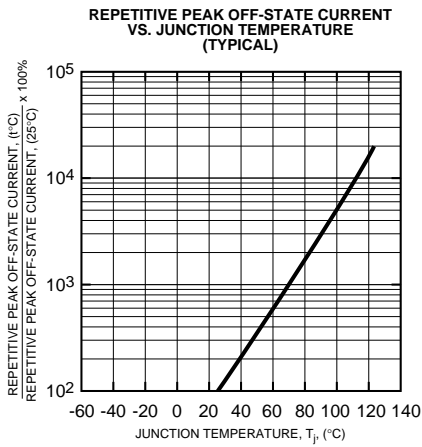
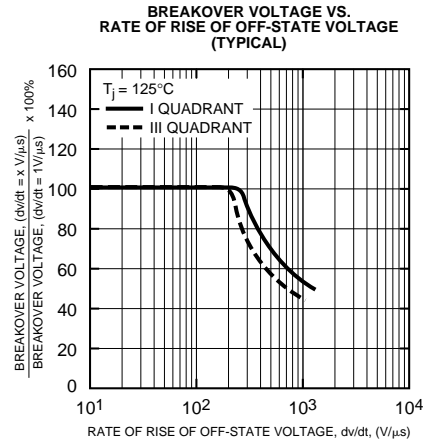
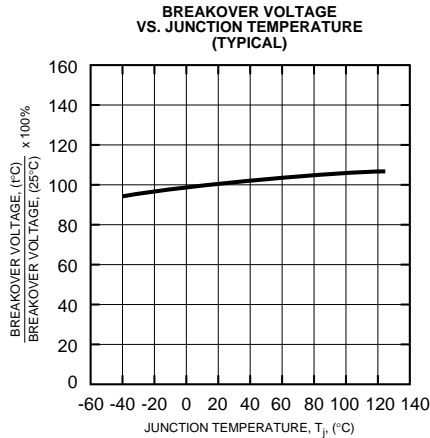
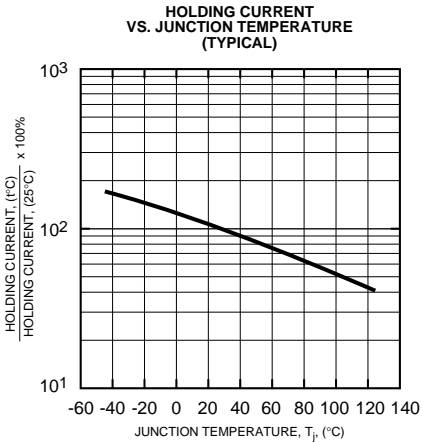

GATE TRIGGER CHARACTERISTICS TEST CIRCUITS

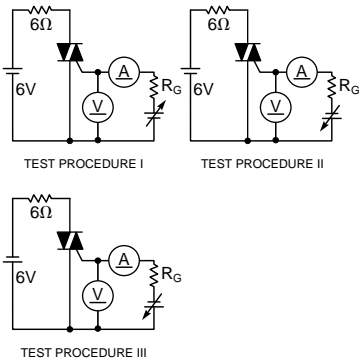

Δ Part Number	V _{DRM} (Volts)	Commutating dv/dt, (dv/dt) _C (V/μsec)		Test Condition	Commutating Voltage & Current Waveform (Inductive Load)
		Minimum	Maximum		
BCR30AM-8L	400	20		T _j = 125°C,	
BCR30AM-12L	600	20		Rate of Decay On-state Commutating Current (di/dt) _C = -016A/msec, Peak Off-state Voltage V _D = 400V	

Copyright © Each Manufacturing Company.

All Datasheets cannot be modified without permission.

This datasheet has been download from :

www.AllDataSheet.com

100% Free DataSheet Search Site.

Free Download.

No Register.

Fast Search System.

www.AllDataSheet.com