



SPX3940/41/42

1A Low Drop Out Voltage Regulator with Shutdown (PRELIMINARY INFORMATION)

FEATURES

- Output Accuracy 3.3V, @ 1A Output
- Very Low Quiescent Current
- Low Dropout Voltage
- Extremely Tight Load And Line Regulation
- Very Low Temperature Coefficient
- Current & Thermal Limiting
- Error Flag Warns Of Output Dropout

APPLICATIONS

- Battery Powered Systems
- Cordless Telephones
- Radio Control Systems
- Portable/Palm Top/Notebook Computers
- Portable Consumer Equipment
- Portable Instrumentation
- Automotive Electronics
- SMPS Post-Regulator
- Voltage Reference

PRODUCT DESCRIPTION

The SPX3940/41/42 is a low power voltage regulator. This device is an excellent choice for battery-powered applications such as cordless telephones, radio control systems and portable computers. The SPX3940/41/42 features very low quiescent current (100µA Typ.) and very low dropout voltage. This includes a tight initial tolerance of 1% max and 2% max., and very low output temperature coefficient, making the SPX3940/41/42 useful as a low-power voltage reference.

The error flag output feature is used as power-on reset for warning of a low output voltage, due to a falling voltage input of batteries. Another feature is the logic-compatible shutdown input which enables the regulator to be switched on and off. The SPX3940/41/42 is offered in 3-pin and 5-pin TO-220 package SOT-223, and surface mount TO-263 packages.

The regulator output voltage (of the 8-pin SO-8 and 5-pin TO-220 & TO-263) may be pin-strapped for a 3.3V or programmed from 1.24V to 29V with an external pair of resistors.

PIN CONNECTIONS

TO-263-5 Package

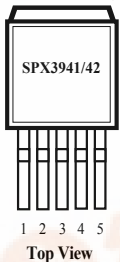

- Five Lead Package Pin Functions:
- | SPX3941 | SPX3942 |
|-------------|----------|
| 1) ERROR | ADJUST |
| 2) INPUT | SHUTDOWN |
| 3) GND | GND |
| 4) OUTPUT | INPUT |
| 5) SHUTDOWN | OUTPUT |

TO-220-5 Package

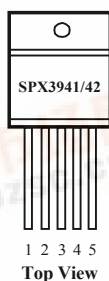

SOT-223 Package

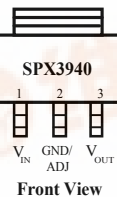

TO-252 Package

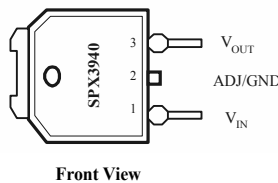

TO-220 Package

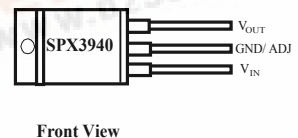

TO-263Package

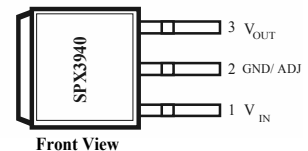

SPX3940/41/42

ABSOLUTE MAXIMUM RATINGS

Power Dissipation.....	Internally Limited
Lead Temp. (Soldering, 5 Seconds)	260°C
Storage Temperature Range	-65° to +150°C
Operating Junction Temperature Range (Note 9) SPX3940/41/42.....	-40°C to +125°C

Input Supply Voltage	+7.5V
Feedback Input Voltage	-1.5V to +30V
Shutdown Input Voltage.....	-0.3V to +30V
Error Comparator Output	-0.3V to +30V
ESD Rating	2KV Min

ELECTRICAL CHARACTERISTICS at $V_S = \pm 15V, T_A = 25^\circ C$, unless otherwise specified. **Boldface** applies over the full operating temperature range.

PARAMETER	CONDITIONS (Note 2)	Typ.	SPX3940A		SPX3940/41		UNITS
			Min	Max	Min	Max	
3.3V Version							
Output Voltage	-40°C ≤ T _J ≤ +125°C 1mA ≤ I _L ≤ 1A	3.3	3.267	3.333	3.234	3.366	V
		3.3	3.217	3.382	3.185	3.415	
All Voltage Options							
Output Voltage Temperature Coefficient	(Note 1)	20		100		150	ppm/°C
Line Regulation (Note 3)	6V ≤ V _{IN} ≤ 30V (Note 4)	20		40		60	mV
Load Regulation (Note 3)	I _L = 50mA to 1mA	35		50		50	mV
				80		80	
Output Noise Voltage	BV = 10Hz – 100kHz I _L = 5mA	150					μV(rms)
Ground Current	4.5V < V _{in} < 5.5V I _L = 5mA	10		15		15	mA
	V _{in} = 5V I _L = 1A	110		200		200	
				250		250	
Current Limit	V _{OUT} = 0	1.7	1.2		1.2		A
Thermal Regulation		0.05		0.2		0.2	%/w
Dropout Voltage (Note 5)	I _L = 1A	0.5		0.8		0.8	V
	I _L = 100mA	110		1.0		1.0	
				150		150	
				200		200	
Adjustable Versions only		Typ	SPX3940/42				
Reference Voltage		1.235			1.200	1.270	V
					1.98	1.272	
Reference Voltage	Over Temperature (Note 6)				1.185	1.285	V
Feedback Pin Bias Current		20				60	nA
						80	
Reference Voltage Temperature Coefficient	(Note 7)	50					ppm/°C
Feedback Pin Bias Current Temperature Coefficient		0.1					nA/°C

SPX3940/41/42

(Continued)

PARAMETER	CONDITIONS (Note 2)	Typ.	SPX3940/42		UNITS
			Min	Max	
Output Leakage Current	$V_{OH} = 30V$	0.01		1.00 2.00	μA
Output Low Voltage	$V_{IN} = 4.5V$ $I_{OL} = 400\mu A$	150		250 400	mV
Upper Threshold Voltage	(Note 8)	60	40 25		mV
Lower Threshold Voltage	(Note 8)	75		95 140	mV
Hysteresis	(Note 8)	15			mV
Input logic Voltage	Low (Regulator ON) High (Regulator OFF)	1.3	2.0	0.7	V
Shut down Pin Input Current	$V_S = 2.4V$	30		90 150	μA
	$V_S = 30V$	450		800 1000	
Regulator Output Current in Shutdown		3		15 25	μA

Note 1: Output or reference voltage temperature coefficients defined as the worst case voltage change divided by the total temperature range.

Note 2: Unless otherwise specified all limits are guaranteed for $T_J = 25^\circ C$, $V_{IN} = 6V$, $I_L = 100\mu A$ and $C_L = 1\mu F$. Additional conditions for the 8-pin versions are feedback tied to 5V tap and output tied to output sense ($V_{OUT} = 5V$) and $V_{SHUTDOWN} \leq 0.8V$.

Note 3: Regulation is measured at constant junction temperature, using pulse testing with a low duty cycle. Changes in output voltage due to heating effects are covered under the specification for thermal regulation.

Note 4: Line regulation for the SPX3940/41/42 is tested at $150^\circ C$ for $I_L = 1\text{ mA}$. For $I_L = 100\mu A$ and $T_J = 125^\circ C$, line regulation is guaranteed by design to 0.2%. See typical performance characteristics for line regulation versus temperature and load current.

Note 5: Dropout voltage is defined as the input to output differential at which the output voltage drops 100 mV below its nominal value measured at 1V differential at very low values of programmed output voltage, the minimum input supply voltage of 2V (2.3V over temperature) must be taken into account.

Note 6: $V_{REF} \leq V_{OUT} \leq (V_{in} - 1V)$, $2.3 \leq V_{in} \leq 30V$, $100\mu A \leq I_L \leq 250\text{ mA}$, $T_J \leq T_{JMAX}$.

Note 7: Comparator thresholds are expressed in terms of a voltage differential at the feedback terminal below the nominal reference voltage measured at 6V input. To express these thresholds in terms of output voltage change, multiply by the error amplifier gain = $V_{OUT}/V_{REF} = (R1 + R2)/R2$. For example, at a programmed output voltage of 5V, the Error output is guaranteed to go low when the output drops by $95\text{ mV} \times 5V/1.235 = 384\text{ mV}$. Thresholds remain constant as a percent of V_{OUT} as V_{OUT} is varied, with the dropout warning occurring at typically 5% below nominal, 7.5% guaranteed.

Note 8: $V_{SHUTDOWN} \geq 2V$, $V_{IN} \leq 30V$, $V_{OUT} = 0$, Feedback pin tied to 5V Tap.

Note 9: The junction -to-ambient thermal resistance of the TO-92 package is $180^\circ C/W$ with 0.4" leads and $160^\circ C/W$ with 0.25" leads to a PC board.

The thermal resistance of the 8-Pin DIP package is $105^\circ C/W$ junction-to-ambient when soldered directly to a PC board. Junction-to-ambient thermal resistance for the SOIC (S) package is $160^\circ C/W$.

APPLICATION HINTS

EXTERNAL CAPACITORS

The stability of the SPX3940/41/42 requires a 2.2 μ F or greater capacitor between output and ground. Oscillation could occur without this capacitor. Most types of tantalum or aluminum electrolytic works fine here. For operations of below -25°C solid tantalum is recommended since the many aluminum types have electrolytes that freeze at about -30°C. The ESR of about 5 Ω or less and resonant frequency above 500kHz are the most important parameters in the value of the capacitor. The capacitor value can be increased without limit.

At lower values of output current, less output capacitance is required for stability. For the currents below 10mA the value of the capacitor can be reduced to 0.5 μ F and 0.15 μ F for 1A. More output capacitance needed for the 8-pin version at voltages below 5V since it runs the error amplifier at lower gain. At worst case 5 μ F or greater must be used for the condition of 250mA load at 1.23V output.

The SPX3940/41/42, unlike other low dropout regulators will remain stable and in regulation with no load in addition to the internal voltage divider. This feature is especially important in application like CMOS RAM keep-alive. When setting the output voltage of the SPX3940/41/42, a minimum load of 10mA is recommended.

If there is more than 10 inches of wire between the input and the AC filter capacitor or if a battery is used as the input then a 0.1 μ F tantalum or aluminum electrolytic capacitor should be placed from the input to the ground.

Instability can occur if there is stray capacitance to the SPX3940/41/42 feedback terminal (pin 7). This could cause more problems when using a higher value of external resistors to set the output voltage.

This problem can be fixed by adding a 100pF capacitor between output and feedback and increasing the output capacitor to at least 3.3 μ F.

ERROR DETECTION COMPARATOR OUTPUT

The Comparator produces a logic low output whenever the SPX3940/41/42 output falls out of regulation by more than around 5%. This is around 60mV offset divided by the 1.235 reference voltage. This trip level remains 5% below normal regardless of the programmed output voltage of the regulator. Figure 1 shows the timing diagram depicting the ERROR signal and the regulator output voltage as the SPX3940/41/42 input is ramped up and down. The ERROR signal becomes low at around 1.3V input, and goes high around 5V input (input voltage at which $V_{out} = 4.75$). Since the SPX3940/41/42's dropout voltage is load dependent, the input voltage trip point (around 5V) will vary with the load current. The output voltage trip point (approx. 4.75V) does not vary with load.

The error comparator has an open-collector output, which requires an external pull-up resistor. Depending on the system requirements the resistor may be returned to 5V output or other supply voltage. In determining the value of this resistor, note that the output is rated to sink 400 μ A, this value adds to battery drain in a low battery condition. Suggested values range from 100K to 1M Ω . If the output is unused this resistor is not required.

PROGRAMMING THE OUTPUT VOLTAGE OF SPX3940/41/42

The SPX3940/41/42 may be pin-strapped for 5V using its internal voltage divider by tying Pin 1 (output) to Pin 2 (sense) and Pin 7 (feedback) to Pin 6 (5V Tap).

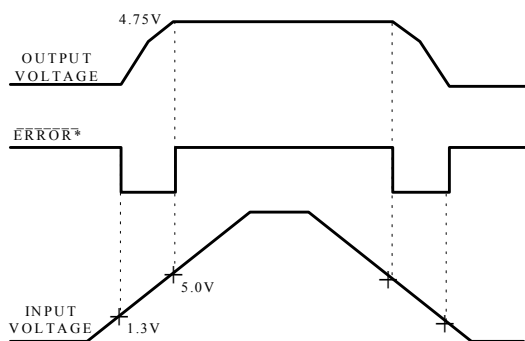

* See Application Info.

Figure 1. ERROR Output Timing

Also, it may be programmed for any output voltage between its 1.235V reference and its 30V maximum rating. As seen in Figure 2, an external pair of resistors is required.

Refer to the below equation for the programming of the output voltage::

$$V_{OUT} = V_{REF} \times (1 + R_1/R_2) + I_{FB}R_1$$

The V_{REF} is 1.235 and I_{FB} is the feedback bias current, nominally -20nA. The minimum recommended load current of 1 μ A forces an upper limit of 1.2 M Ω on value of R_2 . If no load is presented the I_{FB} produces an error of typically 2% in V_{OUT} , which may be eliminated at room temperature by trimming R_1 . To improve the accuracy choose the value of $R_2 = 100k$ this reduces the error by 0.17% and increases the resistor program current by 12 μ A. Since the LP2951 typically draws 60 μ A at no load with Pin 2 open-circuited this is a small price to pay

REDUCING OUTPUT NOISE

It may be an advantage to reduce the AC noise present at the output. One way is to reduce the regulator bandwidth by increasing the size of the output capacitor. This is the only way that noise can be reduced on the 3 lead SPX3940/41/42 but is relatively inefficient, as increasing the capacitor from 1 μ F to 220 μ F only decreases the noise from 430 μ V to 160 μ V Vrms for a 100kHz bandwidth at 5V output. Noise could also be reduced fourfold by a bypass capacitor across R_1 , since it reduces the high frequency gain from 4 to unity. Pick

$$C_{BYPASS} \cong 1 / 2\pi R_1 \times 200 \text{ Hz}$$

or choose 0.01 μ F. When doing this, the output capacitor must be increased to 3.3 μ F to maintain stability. These changes reduce the output noise from 430 μ V to 100 μ V Vrms for a 100kHz bandwidth at 5V output. With the bypass capacitor added, noise no longer scales with output voltage so that improvements are more dramatic at higher output voltages.

HEAT SINK REQUIREMENTS

Depending on the maximum ambient temperature and maximum power dissipation a heat sink may be required with the SPX3940/41/42. The junction temperature range has to be within the range specified under Absolute Maximum Ratings under all possible operating conditions. To find out if a heat sink is required, the maximum power dissipation of the device needs to be calculated. This is the maximum specific AC voltage that must be taken into consideration at input. Figure 3 shows the condition and power dissipation which should be calculated with the following formula:

$$P_{TOTAL} = (V_{IN} - 5) I_L + (V_{IN})I_G$$

Next step is to calculate the temperature rise T_R (max). T_J (max) maximum allowable junction temperature, T_A (max) maximum ambient temperature :

$$T_R (\text{max}) = T_J (\text{max}) - T_A (\text{max})$$

Junction to ambient thermal resistance $\theta_{(J-A)}$ can be calculated after determining of P_{TOTAL} & T_R (max):

$$\theta_{(J-A)} = T_R (\text{max})/P_{(\text{max})}$$

If the $\theta_{(J-A)}$ is 60 $^{\circ}$ C/W or higher, the device could be operated without a heat sink. If the value is below 60 $^{\circ}$ C/W then the heat sink is required and the thermal resistance of the heat sink can be calculated by the following formula, $\theta_{(J-C)}$ junction to case, $\theta_{(C-H)}$ case to heat sink, $\theta_{(H-A)}$ heat sink to ambient:

$$\theta_{(J-A)} = \theta_{(J-C)} + \theta_{(C-H)} + \theta_{(H-A)}$$

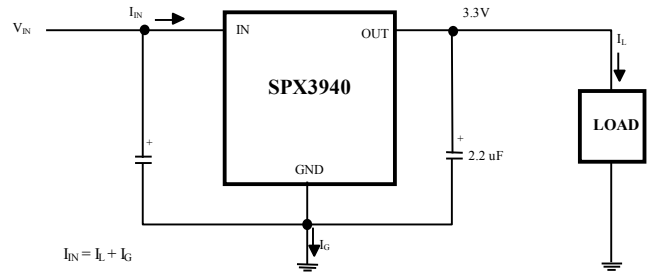
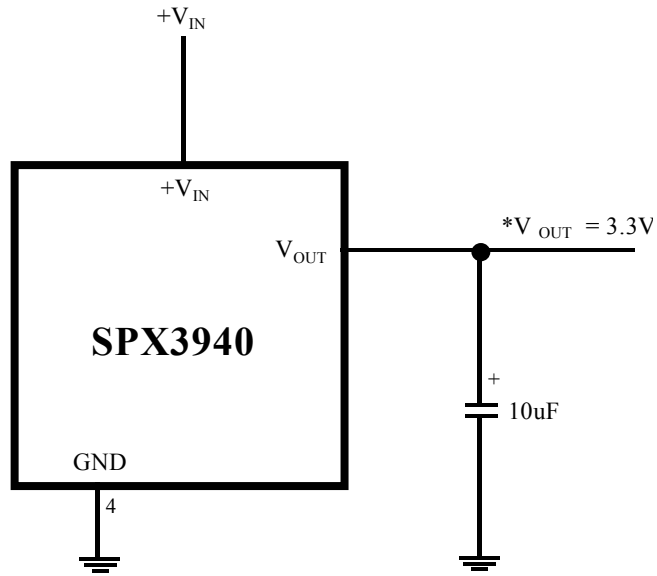

Figure 3. 3.3V Regulator Circuit

TYPICAL APPLICATIONS



SPX3940 FIXED +3.3V REGULATOR

ORDERING INFORMATION

Ordering No.	Precision	Output Voltage	Packages
SPX3940AM3	1%	Adj	3 Lead SOT-223
SPX3940AM3-3.3	1%	3.3V	3 Lead SOT-223
SPX3940AM3-5.0	1%	5.0V	3 Lead SOT-223
SPX3940M3	2%	Adj	3 Lead SOT-223
SPX3940M3-3.3	2%	3.3V	3 Lead SOT-223
SPX3940M3-5.0	2%	5.0V	3 Lead SOT-223
SPX3940AR	1%	Adj	5 Lead TO-252
SPX3940AR-3.3	1%	3.3V	3 Lead TO-252
SPX3940AR-5.0	1%	5.0V	3 Lead TO-252
SPX3940R	2%	Adj	5 Lead TO-252
SPX3940R-3.3	2%	3.3V	3 Lead TO-252
SPX3940R-5.0	2%	5.0V	3 Lead TO-252
SPX3940AU	1%	Adj	5 Lead TO-220
SPX3940AU-3.3	1%	3.3V	3 Lead TO-220
SPX3940AU-5.0	1%	5.0V	3 Lead TO-220
SPX3940U	2%	Adj	5 Lead TO-220
SPX3940U-3.3	2%	3.3V	3 Lead TO-220
SPX3940U-5.0	2%	5.0V	3 Lead TO-220
SPX3940AT	1%	Adj	5 Lead TO-263
SPX3940AT-3.3	1%	3.3V	3 Lead TO-263
SPX3940AT-5.0	1%	5.0V	3 Lead TO-263
SPX3940T	2%	Adj	5 Lead TO-263
SPX3940T-3.3	2%	3.3V	3 Lead TO-263
SPX3940T-5.0	2%	5.0V	3 Lead TO-263
SPX3941R-3.3	2%	3.3V	3 Lead TO-252
SPX3941R-5.0	2%	5.0V	3 Lead TO-252
SPX3941U-3.3	2%	3.3V	3 Lead TO-220
SPX3941U-5.0	2%	5.0V	3 Lead TO-220
SPX3941T-3.3	2%	3.3V	3 Lead TO-263
SPX3941T-5.0	2%	5.0V	3 Lead TO-263
SPX3942R	2%	Adj	5 Lead TO-252
SPX3942U	2%	Adj	3 Lead TO-220
SPX3942T	2%	Adj	3 Lead TO-263



SIGNAL PROCESSING EXCELLENCE

Sipex Corporation

Headquarters and Main Offices:
22 Linnell Circle
Billerica, MA 01821
TEL: (978) 667-8700
FAX: (978) 670-9001
e-mail: sales@sipex.com

233 South Hillview Drive
Milpitas, CA 95035
TEL: (408) 935-7600
FAX: (408) 934-7500