

DIODE(THREE PHASES BRIDGE TYPE)

DF30BA40/80

UL:E76102(M)

Power Diode Module **DF30BA** is designed for three phase full wave rectification, which has six diodes connected in a three phase bridge configuration. The mounting base of the module is electrically isolated from semiconductor elements for simple heatsink construction output DC current is 30Amp ($T_c=122^\circ\text{C}$) Repetitive peak reverse voltage is up to 800V.

- $T_{j\text{Max}}=150^\circ\text{C}$
- Isolated Mounting Base
- High reliability by unique glass passivation
- Easy Assemble by the #250 terminal Tab

(Applications)

AC. DC Motor Drive/AVR/Switching
—for three phase rectification

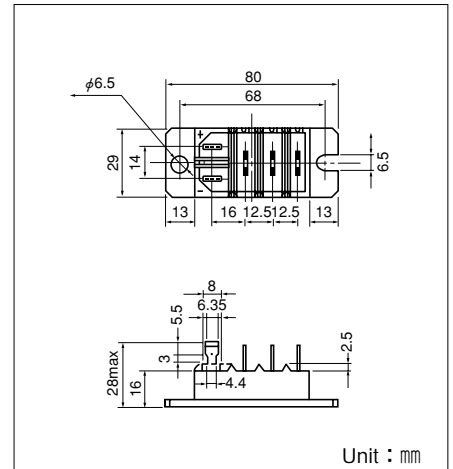
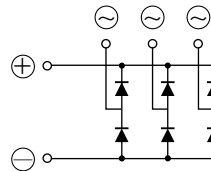

Unit : mm

Maximum Ratings

($T_j=25^\circ\text{C}$ unless otherwise specified)

Symbol	Item	Ratings		Unit
		DF30BA40	DF30BA80	
V_{RRM}	Repetitive Peak Reverse Voltage	400	800	V
V_{RSM}	Non-Repetitive Peak Reverse Voltage	480	960	V

Symbol	Item	Conditions	Ratings	Unit	
I_D	Output current (D.C.)	Three phase. full wave. $T_c=122^\circ\text{C}$	30	A	
I_{FSM}	Surge Forward Current	1 cycle, 50/60Hz, peak value, non-repetitive	410/450	A	
T_j	Junction Temperature		-40 to +150	$^\circ\text{C}$	
T_{stg}	Storage Temperature		-40 to +125	$^\circ\text{C}$	
V_{ISO}	Isolation Breakdown Voltage (R.M.S.)	Main Terminal to case 1minute	2500	V	
	Mounting Torque	Mounting (M6)	Recommended Value 2.5-3.9 (25-40)	4.7 (48)	N·m (kgf·cm)
		Terminal	Tab Terminal # 250	—	
	Mass	Typical Value	90	g	

Electrical Characteristics

Symbol	Item	Conditions	Ratings	Unit
I_{RRM}	Repetitive Peak Reverse Current, max.	$T_j=150^\circ\text{C}$ at V_{RRM}	1.5	mA
V_{FM}	Forward Voltage Drop, max.	$I_{FM}=30\text{A}$, $T_j=25^\circ\text{C}$ Inst. measurement	1.1	V
$R_{th(j-c)}$	Thermal Impedance, max.	Junction to case	0.42	$^\circ\text{C/W}$

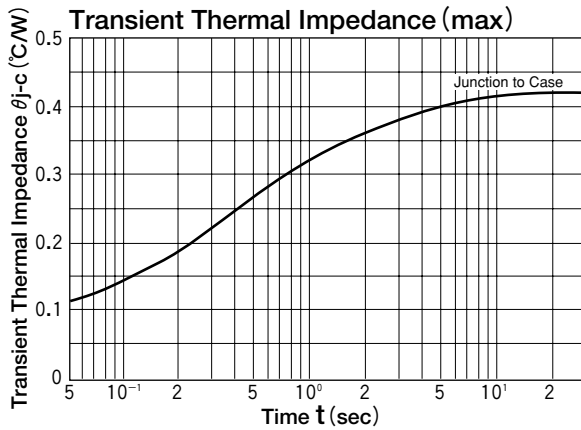
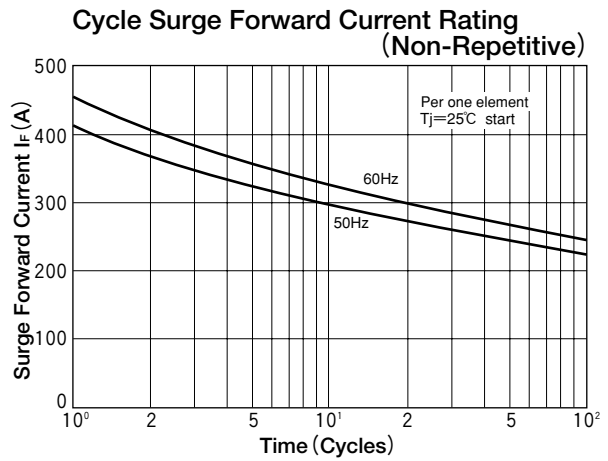
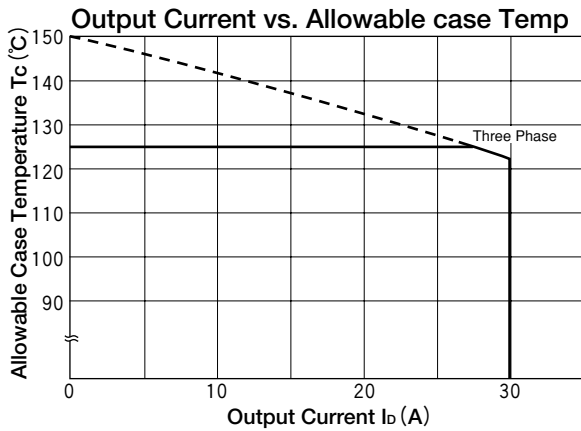
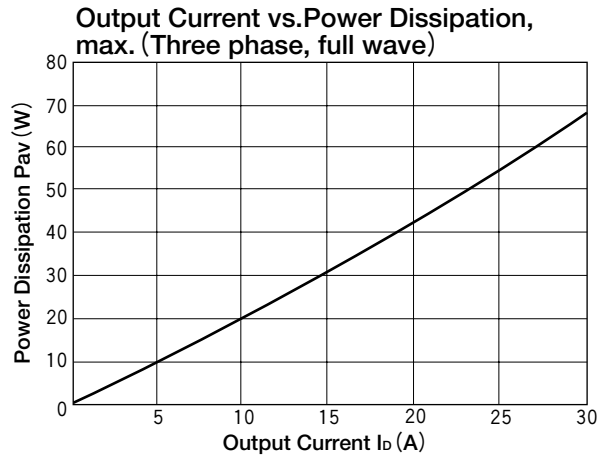
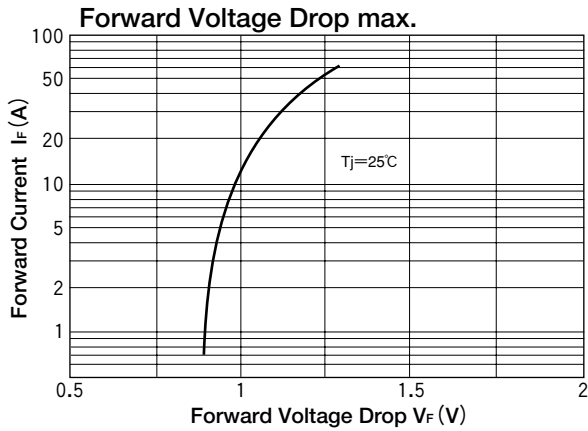

Copyright © Each Manufacturing Company.

All Datasheets cannot be modified without permission.

This datasheet has been download from :

www.AllDataSheet.com

100% Free DataSheet Search Site.

Free Download.

No Register.

Fast Search System.

www.AllDataSheet.com